

**MAKING A DIFFERENCE
FROM THE GROUND UP**





South32 Limited
an Australian company
(ACN 093732597)
(formerly known as BHP Coal
Holdings Pty Limited)
Share code: S32 ISIN AU000000S320
("South32" or the "Company")

PRE-LISTING STATEMENT

This Pre-Listing Statement is issued in compliance with the Listings Requirements of the JSE Limited

The definitions and interpretations commencing on page 205 of this Pre-Listing Statement (also known as the "**South32 Listing Document**") apply *mutatis mutandis* throughout this entire document.

This Pre-Listing Statement is not an invitation to subscribe for shares in South32, but is issued in compliance with the Listings Requirements of the JSE for the purpose of providing information to the public with regard to the business and affairs of South32, its consolidated subsidiaries, special purpose entities, joint ventures and associated companies as at the time of listing. This Pre-Listing Statement has been prepared on the assumption that the Demerger (as defined in the definitions section of this Pre-Listing Statement) shall become effective and be implemented.

The South32 directors, whose names are set out in page 99 of this Pre-Listing Statement, collectively and individually, accept full responsibility for the accuracy of the information provided in this Pre-Listing Statement and certify that, to the best of their knowledge and belief, there are no other facts, the omission of which would make any statement in this Pre-Listing Statement false or misleading, and confirm that they have made all reasonable enquiries in this regard and confirm that this Pre-Listing Statement contains all information required by the Listings Requirements.

The JSE has agreed to the secondary listing of the entire issued ordinary share capital of South32 in the "Metals and Mining" sector of the main board of the JSE under FTSE Classification "general mining" and the abbreviated name "South32" with effect from the commencement of business on Monday, 18 May 2015.

Application will be made to the ASX for quotation of the South32 Shares (the "**ASX Admission**"). It is expected that the ASX Admission will become effective and that deferred settlement trading on the ASX of the South32 Shares will commence on 18 May 2015. Application will be made to the UK Listing Authority and to the London Stock Exchange for the South32 Shares to be admitted to the standard listing segment of the Official List and to trading on the London Stock Exchange's main market for listed securities, respectively (together, the "**United Kingdom Admission**"). It is expected that the United Kingdom Admission will become effective and that dealings on the London Stock Exchange in the South32 Shares will commence on 26 May 2015 (International Security Identification Number: AU000000S320). 'When issued' dealings in the South32 Shares are expected to commence on the London Stock Exchange on 18 May 2015.

The issued share capital of South32 as at the Last Practicable Date (being 14 March 2015) is 450,000,004 shares with no par value. On the commencement of its listing on the JSE, South32 will have an issued share capital of the same number of issued ordinary shares as the number of issued ordinary shares in BHP Billiton as at the applicable Record Dates (which ordinary shares will have no par value). South32 Shares will be distributed to Eligible Shareholders by way of an in-specie dividend of one South32 Share for each BHP Billiton Share held on the applicable Record Date (subject to the Demerger being implemented). As at the date of

listing, no subsidiaries of South32 will hold any of the issued share capital of South32 as treasury shares.

All the ordinary shares in South32 rank *pari passu* in all respects, there being no conversion or exchange rights attaching thereto and have equal rights to participate in capital, dividend and profit distributions by South32.

The sponsor, financial adviser, reporting accountants and auditors, attorneys, transfer secretaries, independent technical experts and financial communication advisers whose reports and/or names are included in this Pre-Listing Statement, have given and have not withdrawn their consent to the inclusion of their names and/or reports in this Pre-Listing Statement in the form and context in which they appear.

Sponsor and Co-Financial Adviser

UBS AG (financial adviser)
UBS South Africa (JSE sponsor)

South African Attorneys

Transaction counsel:
ENSAfrica
South32 independent counsel:
Werksmans Attorneys

Transfer Secretaries

Computershare

Independent Competent Persons

SRK consulting
Xstract
Runge Pincock Minarco
CSA Global

Australian attorneys

Transaction counsel:
Herbert Smith Freehills
South32 independent counsel:
King & Wood Mallesons

Date of issue: 16 March 2015

This Pre-Listing Statement is available in English only. Copies may be obtained during normal business hours from 18 March 2015 until 18 May 2015 (both days inclusive) from the Sponsor, South32 and the transfer secretaries (Registries), whose details are set out in the "Corporate Directory" section of this Pre-Listing Statement.

Lead Financial Adviser

Goldman Sachs

UK Attorneys

Transaction counsel:
Slaughter and May
South32 independent counsel:
King & Wood Mallesons LLP

US Attorneys

Transaction counsel:
Cleary Gottlieb Steen
& Hamilton LLP

Reporting Accountants and Auditors

Independent accountant:
KPMG Financial Advisory
Services (Australia)
Auditor: KPMG (Australia)

Independent board adviser to the BHP Billiton board

Gresham Advisory
Partners Limited
Simon Robertson
Associates LLP
Investec Bank Limited

CONTENTS

1	SUMMARY	1
2	RISK FACTORS	9
2.1	External risks relating to the industries in which South32 operates	9
2.2	Operational risks	12
2.3	Business risks	15
2.4	Financial risks	15
2.5	Sustainability risks	16
2.6	General risks relating to the South32 Shares	18
3	IMPORTANT INFORMATION	21
3.1	General	21
3.2	Preparation of, and responsibility for, this document	21
3.3	Investment decisions	22
3.4	Forward looking statements	22
3.5	Presentation of financial information	23
3.6	Independent Competent Persons' Reports	24
3.7	Credit rating	24
3.8	Notice to BHP Billiton Shareholders outside Australia, the United Kingdom and South Africa	24
3.9	Where to find help	24
4	KEY TRADING DATES	25
5	SOUTH32 OVERVIEW	27
5.1	Introduction	27
5.2	South32 organisational structure	31
5.3	Strategy	32
5.4	Key strengths	32
5.5	Dividend policy	35
6	MARKET OVERVIEW	37
6.1	Bauxite, alumina and aluminium industry	37
6.2	Energy coal industry	38
6.3	Metallurgical coal industry	39
6.4	Manganese industry	41
6.5	Nickel industry	42
6.6	Silver, lead and zinc industry	44
7	SOUTH32 BUSINESS DESCRIPTION	47
7.1	South32 Businesses	47
7.2	Summary of Mineral Resources and Ore Reserves information	81
7.3	Description of joint ventures and other interests held by South32	92
7.4	South32 marketing	93
7.5	Employees	94
7.6	Government regulation overview	96
7.7	Health, Safety, Environment and Community	96

8	DIRECTORS, SENIOR MANAGEMENT AND CORPORATE GOVERNANCE	99
8.1	Directors	99
8.2	Senior management	101
8.3	Shareholdings and interests of South32 Directors, senior management and other specified persons	105
8.4	Conflicts of interest	106
8.5	Confirmations	106
8.6	Business address	106
8.7	Equity Incentive Plans	106
8.8	Corporate governance	110
9	SELECTED HISTORICAL COMBINED FINANCIAL INFORMATION	115
9.1	Overview	115
9.2	Summary of South32's historical combined financial information	116
9.3	Capitalisation and indebtedness statement	117
10	SUMMARY OF PRO FORMA HISTORICAL FINANCIAL INFORMATION	119
10.1	Overview	119
10.2	Basis of preparation	119
10.3	South32 summary pro forma historical consolidated income statements	121
10.4	South32 summary pro forma historical consolidated cash flow statements before financing activities and tax and after capital expenditure	122
10.5	South32 pro forma historical consolidated balance sheet	123
10.6	Debt facilities	125
10.7	Pro forma net indebtedness summary	126
10.8	Accounting judgements and estimates	126
10.9	Taxation	128
11	OPERATING AND FINANCIAL REVIEW AND PROSPECTS	129
11.1	Introduction	129
11.2	External factors and trends affecting South32's results	131
11.3	Operating results – Underlying Earnings	138
11.4	Consolidated results – overview	138
11.5	Operating results	139
11.6	Business performance	147
11.7	Third party sales	159
11.8	Cash flow analysis	160
11.9	Net debt and sources of liquidity	161
12	INDEPENDENT ACCOUNTANT'S ASSURANCE REPORT	163
13	TAXATION	171
13.1	Important information	171
13.2	Australian tax consequences of holding South32 Shares	171
13.3	United Kingdom tax consequences of holding South32 Shares	173
13.4	United States federal income tax consequences of holding South32 Shares or South32 ADSs	174
13.5	South African tax consequences of holding South32 Shares	175
13.6	New Zealand tax consequences of holding South32 shares	176
14	INFORMATION ON THE DEMERGER	177
14.1	Introduction	177
14.2	Internal Restructure	177
14.3	Implementation of the Demerger	178
14.4	Demerger Agreements	178

15	ADDITIONAL INFORMATION	183
15.1	Incorporation and activities of South32	183
15.2	Corporate history	183
15.3	Share capital of South32	183
15.4	Summary of South32's Constitution	185
15.5	Listing	188
15.6	South32 shareholdings	188
15.7	Trading your South32 Shares	192
15.8	Foreign ownership and other shareholding restrictions – general	193
15.9	South African exchange control limitations affecting shares	193
15.10	ASX, ASIC, JSE and SARB waivers, confirmations and relief	195
15.11	Government protections and investment encouragement laws	196
15.12	Organisational structure	196
15.13	Details on South32 Directors and senior management	197
15.14	Pensions	199
15.15	Litigation	199
15.16	Material contracts	200
15.17	Material royalties	200
15.18	Property, plant and equipment	200
15.19	Significant change	200
15.20	Working capital statement	200
15.21	Announcement of completion of the Demerger and the admission of South32 Shares	200
15.22	Consents	201
15.23	Independent Competent Persons' and Competent Persons' interests in BHP Billiton Shares	202
15.24	Related party transactions	203
15.25	No incorporation of website information	203
15.26	Costs and expenses	203
15.27	Sources and bases of selected financial and other information	204
15.28	Documents available for inspection	204
16	DEFINITIONS AND GLOSSARY OF TECHNICAL TERMS	205
16.1	Definitions	205
16.2	Units of measure	212
16.3	Terms used in relation to reserves and resources	212
16.4	Rounding	212
ANNEXURES		213
Annexure 1 – Historical combined financial information for the years ended 30 June 2014, 30 June 2013 and 30 June 2012 for South32		215
Annexure 2 – Half year historical combined financial information for the Half Year periods ended 31 December 2014 and 31 December 2013 for South32		275
Annexure 3 – South32 pro forma historical consolidated income statement and cash flow statement reconciliations		295
Annexure 4 – South32 pro forma segment reporting		299
Annexure 5 – Selected financial metrics for the past 10 financial years		303
Annexure 6 – Independent Competent Persons' Reports		311
CORPORATE DIRECTORY		IBC

This page has been intentionally left blank.

1 SUMMARY

The information in this document has been prepared to meet the disclosure requirements associated with the admission to trading of South32's ordinary shares on the ASX, JSE and LSE (as noted in Section 15.10(b), ASIC has granted an exemption from the prospectus provisions in the Corporations Act and this document is not a prospectus under the Corporations Act). It therefore reflects and meets the disclosure requirements of three jurisdictions.

The form and content of the summary below are prescribed by European Union Regulation and are required to be included for the purposes of the admission of the South32 Shares to trading on the LSE. The statements in Section A.1 in relation to claims based on the summary are only applicable where claims are brought on the basis of the UK Prospectus and do not alter the rights or liabilities of any person in relation to the information memorandum for the purposes of the listing of South32 Shares on the ASX or the pre-listing statement for the purposes of the listing of South32 Shares on the JSE.

Summaries are made up of disclosure requirements known as 'Elements'. These Elements are numbered in Sections A-E (A.1-E.7).

This summary contains all the Elements required to be included in a summary for this type of securities and issuer. Because some Elements are not required to be addressed, there may be gaps in the numbering sequence of the Elements.

Even though an Element may be required to be inserted in the summary because of the type of securities and issuer, it is possible that no relevant information can be given regarding the Element. In this case, a short description of the Element is included in the summary with the mention of 'not applicable'.

SECTION A – INTRODUCTION AND WARNING

A.1 Warning

This summary should be read as an introduction to this document. Any decision to invest in South32 Shares should be based on consideration of this document as a whole by the investor. Where a claim relating to the information contained in this document is brought before a court, the plaintiff investor might, under the national legislation of the member states of the European Economic Area, have to bear the costs of translating this document before the legal proceedings are initiated. Civil liability attaches only to those persons who have tabled the summary including any translation thereof, but only if the summary is misleading, inaccurate or inconsistent when read together with other parts of this document or it does not provide, when read together with other parts of this document, key information in order to aid investors when considering whether to invest in such securities.

A.2 Any consents to and conditions regarding use of this document

Not applicable.

SECTION B – ISSUER

B.1 Legal and commercial name of the company

South32 Limited

B.2 Domicile and legal form of the company

South32 is a public company incorporated in Australia on 12 July 2000 (formerly known as BHP Coal Holdings Pty Limited) and registered under the Corporations Act.

B.3 Description of South32's current operations and principal activities

Following implementation of the Demerger, South32 will be a globally diversified metals and mining company with a portfolio of assets producing alumina, aluminium, coal, manganese, nickel, silver, lead and zinc. South32 will have multiple large assets, the majority of which are competitively positioned in the first or second quartile of their respective industry cost curves. South32's operated assets will have the advantage of having historically been managed and maintained in accordance with BHP Billiton's standards and practices.

South32's portfolio will comprise of the South32 Businesses, which are:

- **Worsley Alumina:** an 86 per cent interest in an integrated bauxite mining and alumina refining operation located in Western Australia, Australia;

- **South Africa Aluminium:** a 100 per cent interest in the Hillside smelter near Richards Bay, South Africa. The business previously included the Bayside smelter, which was closed in FY2014, and Bayside casthouse. An agreement has been reached for the sale of the assets comprising the Bayside casthouse (the sale is subject to certain regulatory and other conditions, which are expected to be fulfilled in the first half of CY2015);
- **Mozal Aluminium:** a 47.1 per cent interest in the Mozal Aluminium smelter located near Maputo, Mozambique;
- **Brazil Aluminium:** a 14.8 per cent interest in the Mineração Rio do Norte open-cut bauxite mine (**MRN Mine**), as well as a 36 per cent interest in the Alumar alumina refinery and a 40 per cent interest in the Alumar aluminium smelter (together with certain interests in ancillary facilities and lands);
- **South Africa Energy Coal:** a 90 per cent interest in four operating energy coal mines in the Witbank region in the Mpumalanga province of South Africa;
- **Illawarra Metallurgical Coal:** a 100 per cent interest in three underground metallurgical coal mines located near Wollongong in New South Wales, Australia;
- **Australia Manganese:** a 60 per cent interest in the Groote Eylandt Mining Company (**GEMCO**) open-cut manganese mine and the Tasmanian Electro Metallurgical Company (**TEMCO**) manganese alloy plant. GEMCO is located in the Northern Territory, Australia near port facilities at Milner Bay, and TEMCO is located in Tasmania, Australia, near the Bell Bay wharf;
- **South Africa Manganese:** a 44.4 per cent effective interest in the Mamatwan open-cut mine and the Wessels underground mine (collectively known as the **Hotazel Mines**) and a 60 per cent interest in the Samancor Manganese Metalloys alloy plant (**Metalloys**). The Hotazel Mines are located near the town of Kuruman, South Africa;
- **Cerro Matoso:** a 99.94 per cent interest in an open-cut lateritic nickel mine and ferronickel smelter located near Montelibano, in the Córdoba Department in northern Colombia;
- **Cannington:** a 100 per cent interest in a silver, lead and zinc underground mine and concentrator operation located in northwest Queensland, Australia, approximately 200 km southeast of Mount Isa.

B.4a Description of significant trends affecting the company and the industries in which it operates

As a company which mines and produces commodities used in a range of manufacturing and industrial processes, South32 is exposed to fluctuations in the prices of its key commodities. Global demand and supply for the commodities the South32 Businesses produce are key drivers of commodity prices, and fluctuations in product demand and supply therefore affect South32's results, including cash flows and asset values.

B.5 Description of the South32 Group and the company's position within it

South32 is an Australian public company, which will be the holding company of the South32 Group. As at the date of this document, South32 is a wholly-owned subsidiary of BHP Billiton Limited. As part of the Demerger, South32 will be separated from the BHP Billiton Group to operate as a standalone entity.

South32 will be headquartered in Perth, Australia, with its Australian operations managed from Perth and African operations managed from a regional head office in Johannesburg, South Africa. South32 will also have a global shared service centre located in Johannesburg, South Africa.

B.6 Interests in the company and voting rights

As at 14 March 2015 (being the latest practicable date prior to the publication of this document), the entire issued share capital of South32 is held by BHP Billiton Limited. Following the Demerger, the shareholders of South32 shall be the same as the shareholders of BHP Billiton as at the relevant Record Date, except where BHP Billiton Shareholders are Ineligible Overseas Shareholders or elect to sell their South32 Shares pursuant to the Sale Facility.

To the knowledge of South32 and BHP Billiton Limited:

- BHP Billiton is not (and therefore South32, immediately following the Demerger, will not be) directly or indirectly majority owned or controlled by another corporation or by any foreign government.
- Immediately following the implementation of the Demerger, there is no person who, directly or indirectly, jointly or severally, will exercise or could exercise control over South32.
- There are no arrangements the operation of which may at a subsequent date result in a change in control of BHP Billiton or South32 (other than as a result of implementation of the Demerger).
- No public takeover offers by third parties have been made in respect of BHP Billiton's shares during the current and preceding financial year.

As at 14 March 2015 (being the latest practicable date prior to the publication of this document), to the knowledge of South32 and BHP Billiton Limited, there are no persons that are directly or indirectly interested in five per cent or more of the issued shares in BHP Billiton Limited and the following persons are directly or indirectly interested in three per cent or more of the issued shares in BHP Billiton Plc:

- Aberdeen Asset Managers Limited, which holds 157,061,561 shares of which it controls voting rights in respect of 127,971,161 shares, representing 6.06 per cent of the BHP Billiton Plc Shares on issue (as notified on 13 March 2015);
- BlackRock Inc, which holds and controls voting rights in respect of 213,014,043 shares, representing 10.08 per cent of the BHP Billiton Plc Shares on issue (as notified on 3 December 2009),

and none of the shareholders referred to above has or will have different voting rights from any other holder of South32 Shares in respect of any South32 Shares held by them.

B.7 Selected historical combined financial information

The table below sets out summary historical combined financial information for the six months ended 31 December 2014 (H1 FY2015) and the six months ended 31 December 2013 (H1 FY2014), which has been extracted from the historical combined financial information of the South32 Group set out in Annexure 2, and for the twelve months ended 30 June 2014 (FY2014), the twelve months ended 30 June 2013 (FY2013) and the twelve months ended 30 June 2012 (FY2012), which has been extracted from the historical combined financial information of the South32 Group set out in Annexure 1.

Table 1.1: Selected summary South32 historical combined financial information

US\$M	6 months ended December		12 months ended June		
	H1 FY2015	H1 FY2014	FY2014	FY2013	FY2012
Income statement information					
Revenue	5,040	5,348	10,444	12,093	13,835
Profit/(loss) from operations	1,251	554	774	(963)	2,060
Profit/(loss) before taxation	1,214	446	422	(1,096)	2,018
Profit/(loss) after taxation	738	358	217	(1,304)	1,433
Other financial information^(a)					
Underlying EBITDA	1,306	976	2,055	2,118	2,831
Underlying EBIT	800	510	1,070	1,154	1,926
Underlying Earnings	534	369	614	755	1,258
Cash flow information					
Cash generated from operations	1,131	781	2,108	2,138	2,899
Less interest and tax, net of dividends received	118	(288)	(438)	(712)	(506)
Net operating cash flows	1,249	493	1,670	1,426	2,393
Capital expenditure	(411)	(394)	(769)	(1,139)	(2,013)
Net operating cash flows after capital expenditure	838	99	901	287	380
Balance sheet information					
Current assets	12,630	5,361	5,002	5,236	7,544
Non-current assets	14,093	14,322	14,688	14,307	16,468
Total assets	26,723	19,683	19,690	19,543	24,012
Current liabilities	1,936	2,601	2,133	2,764	3,194
Non-current liabilities	7,240	6,793	7,737	6,659	7,006
Total liabilities	9,176	9,394	9,870	9,423	10,200
Net assets/Total invested capital	17,547	10,289	9,820	10,120	13,812

(a) Underlying Earnings is the key measure that South32 proposes to use to assess the performance of South32, make decisions on the allocation of resources and assess senior management. In addition, the performance of each of the South32 Businesses and operational management will be assessed based on Underlying EBIT. Underlying EBITDA and Underlying EBIT are calculated based on the accounting policies that South32 proposes to use when discussing its operating results in future periods. Refer to note 2 Segment reporting of Annexure 1 for further details of this approach. The accounting policies proposed by South32 for calculating these measures differ from those currently used by BHP Billiton, the key differences being that South32 will adjust for certain items each period, irrespective of materiality, and South32 management will retain the discretion to adjust for other significant non-recurring items that are not considered to reflect the underlying performance of the assets it holds.

The significant changes to South32's financial condition and operating results during or subsequent to the period covered by the historical combined financial information set out above, to the date of this document, are as follows:

- reductions in operating costs, including the benefit of a stronger US dollar, have resulted in improved profitability during H1 FY2015;
- there was a year on year decrease in revenue in FY2014 of US\$1,649 million and US\$1,742 million in FY2013. The primary cause was a fall in prices for most commodities over these periods, which in turn led to a significant decrease in profit attributable to shareholders;
- the fall in commodity prices had an impact on asset values across the period. A decline in export prices for energy coal resulted in impairments booked against the South Africa Energy Coal assets in FY2014 of US\$292 million. The strength in the Australian dollar and weak alumina prices at the time led to a reduction in the asset value of Worsley Alumina in FY2013 of US\$2,190 million;
- cost pressures impacted operating margins leading to the cessation of some smelting activities at South Africa Aluminium in June 2014. Closure costs of US\$167 million were recorded in FY2014 in relation to the cessation of production;
- as part of a regular portfolio review in June 2012, various operations and projects were either suspended or closed early. These included: the temporary suspension of production at Australia Manganese, the permanent closure of the Metalloys South Plant at South Africa Manganese and the termination of the Samancor Manganese Gabon project, resulting in the recognition of US\$93 million in asset write-downs;
- the move to joint control arising from changes to the joint venture arrangements for the Manganese Business effective from 2 March 2015 resulted in a gain of approximately US\$2 billion recorded after 31 December 2014 and the subsequent equity accounting for South32's interest in the Manganese Business;
- certain other adjustments resulting from the Internal Restructure in preparation for the Demerger, including tax charges;
- as part of the Internal Restructure during H1 FY2015 there was an issue of shares to BHP Billiton Limited of US\$8 billion to capitalise South32 to enable the acquisition of the companies that will comprise the South32 Group. The proceeds were primarily placed on deposit with BHP Billiton.

B.8 Selected pro forma historical financial information

The following is a summary of South32 pro forma historical financial information for the periods, which has been prepared to illustrate the effect:

- on the income statement and cash flow statement of the move to joint control of the Manganese Business and the impact of the Demerger (including adjustments to reflect reversal of intercompany net financing costs and dividends), as if they had occurred on 1 July 2013;
- on the balance sheet, of the move to joint control of the Manganese Business and the Demerger (including adjustments to reflect settlement of intercompany balances between South32 and BHP Billiton and Demerger set up costs to be incurred by South32 after the Demerger takes effect), as if they had occurred on 31 December 2014.

The South32 pro forma historical financial information has been prepared, and is intended, for illustrative purposes only. It addresses a hypothetical situation and therefore does not purport to reflect South32's actual financial performance or the actual financial position that South32 would have achieved if South32 had operated as a standalone entity for the periods presented.

Table 1.2: Selected summary of South32's pro forma historical income statement and cash flow information^(a)

US\$M	6 months ended December H1 FY2015	12 months ended June FY2014
Income statement information		
Revenue	4,089	8,344
Profit from operations	724	337
Profit before taxation	729	150
Profit after taxation	306	103
Basic earnings per share (US cents)	5.75	1.93
Other financial information		
Underlying EBITDA	1,065	1,483
Underlying EBIT	648	660
Underlying Earnings	442	446
Underlying basic earnings per share (US cents)	8.30	8.38

US\$M	6 months ended December H1 FY2015	12 months ended June FY2014
Cash flow information		
Cash generated from operations	929	1,419
Dividends received (including equity accounted investments)	131	206
Capital expenditure	(317)	(590)
Net operating cash flows before financing activities and tax and after capital expenditure	743	1,035

(a) As described in Section 10.2, no pro forma adjustments have been made to South32's pro forma historical consolidated income statements or cash flow information to reflect the anticipated additional corporate overhead costs or savings of South32 operating as a standalone entity or savings from implementation of South32 regional operating model (refer to Section 11.2(d)).

Table 1.3: Selected summary of South32's pro forma historical balance sheet information

US\$M	South32 31 December 2014	Adjustments	South32 pro forma 31 December 2014
Balance sheet information			
Current assets	12,630	(10,075)	2,555
Non-current assets	14,093	1,037	15,130
Total assets	26,723	(9,038)	17,685
Current liabilities	1,936	(201)	1,735
Non-current liabilities	7,240	(4,240)	3,000
Total liabilities	9,176	(4,441)	4,735
Net assets/Total invested capital	17,547	(4,597)	12,950

B.9 Profit forecast or estimate

Not applicable.

B.10 A description of the nature of any qualifications in the Independent Audit Report on the historical combined financial information

Not applicable. There are no qualifications to the Independent Audit Report on the historical combined financial information.

B.11 Working capital

Not applicable. South32 and its Directors are of the opinion that the South32 Group has sufficient working capital for its present requirements, that is for at least the next 12 months following the date of publication of this document.

SECTION C – SECURITIES

C.1 Types and class of securities being admitted to trading, including the security identification number

This document has been prepared in connection with the demerger of a selection of BHP Billiton Group's alumina, aluminium, coal, manganese, nickel, silver, lead and zinc assets into a separate company, South32. South32 will apply for admission of its ordinary shares to trading on the ASX, JSE and LSE.

Following the Demerger, South32 is expected to have a primary listing on the ASX and a secondary listing of all the issued South32 Shares in the general mining sector of the main board of the JSE and all the issued South32 Shares will be admitted to the standard segment of the Official List and to trading on the LSE's main market for listed securities.

When admitted to trading on the ASX, JSE and LSE, the South32 Shares will be registered with an ISIN AU000000S320.

South32 will also establish an ADS program, but the South32 American Depositary Shares (**ADSs**) will not be listed on the New York Stock Exchange or any other securities exchange in the United States and will trade over-the-counter.

C.2 Currency of the securities in issue

The South32 Shares will be denominated in Australian dollars and quoted in Australian dollars on the ASX, South African rand on the JSE and pounds sterling on the LSE. South32 ADSs will be denominated in US dollars.

C.3 Number of shares in issue and par value

Immediately following the implementation of the Demerger, the issued share capital of South32 will be equal to the aggregate number of BHP Billiton Limited Shares on issue on the Limited Record Date and BHP Billiton Plc Shares on issue on the Plc Record Date. The South32 Shares will have no par value and, immediately following implementation of the Demerger, all South32 Shares will be fully paid.

As at 14 March 2015 (being the latest practicable date prior to the publication of this document), there were 3,211,691,105 BHP Billiton Limited ordinary shares and 2,112,071,796 BHP Billiton Plc ordinary shares on issue.

C.4 Rights of securities

All the South32 Shares will rank pari passu in all respects, there being no conversion or exchange rights attaching thereto, and all of the South32 Shares will have equal rights to participate in capital, dividend and profit distributions by South32.

C.5 Restrictions on the transferability of shares

There are no restrictions on the transferability of the South32 Shares imposed by the South32 Constitution.

C.6 Application for admission to trading on a regulated market

South32 will apply for its ordinary shares to be admitted to trading on the ASX, JSE and LSE.

South32 ADSs will not be listed on the New York Stock Exchange or any other securities exchange in the United States and will trade over-the-counter.

C.7 Dividend policy

The South32 dividend policy will be determined by the South32 Board at its discretion, having regard to South32's first two priorities for cash flow, being a commitment to maintain safe and reliable operations and an intention to maintain an investment grade credit rating through the cycle.

South32 intends to distribute a minimum of 40 per cent of Underlying Earnings as dividends to its shareholders following each six month reporting period. Consistent with South32's priorities for cash flow and commitment to maximise total shareholder returns, other alternatives including special dividends, share buy-backs and high return investment opportunities will compete for excess capital.

South32 will distribute dividends with the maximum practicable franking credits for the purposes of the Australian dividend imputation system. The extent to which a dividend can be franked will depend on South32's franking account balance (which immediately following the Demerger will be nil) and its level of distributable profits. South32's franking account balance will depend on the amount of Australian income tax paid by South32 following the Demerger. The timing of South32's Australian income tax payments may also impact its capacity to frank any dividend declared for the half year ending 31 December 2015.

No assurance can be given in relation to the level of future dividends or the franking of such dividends (if any), as these will depend on future events and circumstances.

South32 does not intend to pay a dividend for the period ending 30 June 2015, which will conclude only one month after the implementation of the Demerger.

SECTION D – RISKS

D.1 Key information on key risks specific to South32 and the industries in which it operates

External risks relating to the industries in which South32 operates

- The prices South32 obtains for its products are determined by, or linked to, prices in world commodity markets, which have historically been subject to substantial volatility. In addition South32's assets, earnings and cash flows are affected by a wide variety of currencies, with the US dollar being the currency in which the majority of South32's sales are determined, and South32's operating costs are also influenced by the currencies of the countries in which it operates. Fluctuations in commodity prices, currency exchange rates and impacts of ongoing global economic volatility may negatively affect South32's results, including cash flows and asset values.
- Actions by governments or political events could have a negative impact on South32 or the South32 Businesses. In particular, South32 or the South32 Businesses could be adversely affected by new or changed government regulations, such as controls on imports, exports and/or prices and changes in fiscal legislation. In addition, South32 or the South32 Businesses could be exposed to the risk of terrorism, civil unrest, nationalisation, renegotiation or nullification of existing contracts, leases, permits or other agreements, particularly in emerging markets in which the South32 Businesses operate.

- Audits and reviews by administrative bodies, in particular tax authorities, may result in South32 incurring additional tax or royalty payments. South32 is currently the subject of a number of tax-related claims.

Operational risks

- South32 Businesses are dependent on access to infrastructure that is economical, and without such access these operations may be disrupted or further development may be prevented. A number of factors could disrupt the availability of the services utilised by the South32 Businesses to transport products to customers, including weather-related problems, rail or port capacity and allocation constraints, key equipment and infrastructure failures and industrial action.
- South32 Businesses are dependent on access to water and power that is economical. Such access to water and power may be disrupted or further development may be prevented due to factors such as climate (including drought), changes in allocations, changes in activities or conditions at South32's operations, elections by contract counterparties to cease current arrangements, the term of contractual arrangements ending or changes in government policy.
- Unexpected natural or operational catastrophes may adversely impact South32's operations or cause harm to its assets or equipment. In particular, the South32 Businesses rely on access to key port and rail infrastructure which may be subject to port, shipping or rail incidents and include six underground mines that can be exposed to incidents such as fire and explosion, loss of power supply and critical equipment failures.

Business risks

- Failure to maintain, realise or enhance existing reserves, discover new reserves or develop new operations could negatively affect South32's future results and financial condition. Production from South32's operations results in existing reserves being depleted over time. The volume and quality of product the South32 Businesses recover may be less than South32 or Competent Persons have estimated. In addition, Mineral Resources and Ore Reserves estimates are expressions of judgement based on knowledge, experience and industry practice, among other things.

Financial risks

- South32 is required in its financial statements to include provisions for the expected closure and rehabilitation costs of its operations. Closure and rehabilitation costs require significant judgements and estimates and are therefore subject to change. South32 and its management consider its closure and rehabilitation provisions to be appropriate based on currently available information (including estimated closure dates) and certain assumptions. However, given inherent uncertainties, the future actual expenditure may differ from the amounts currently provided.
- One or more of the South32 Businesses may be affected by changed market or industry structures, commodity prices, technical operating difficulties, inability to recover its Ore Reserves or increased operating cost levels. These may cause South32 to fail to recover all or a portion of its investment in mining assets and may require financial write-downs, adversely impacting financial results.

Sustainability risks

- South32 and/or its workforce may be adversely affected by health and safety and environmental risks in respect of its activities. Longer-term health impacts may arise due to the exposure of the South32 workforce to hazardous substances. Potential safety events that may have an adverse impact on South32's operations may occur. In addition South32's operations, by their nature, have the potential to impact biodiversity, land, water resources and related ecosystems including from the discharge of contaminants.
- South32's operations are exposed to a range of water and waste water management risks, including water scarcity, water excess, water quality, water discharge or discharge into ground water issues. Some assets are more prone than others to these water management-related risks.
- South32 Businesses may be disrupted without the support of the local communities in which they are located. Notwithstanding South32's contributions to the communities in which the South32 Businesses are located, local communities may become dissatisfied with the impact of South32's operations or oppose new development projects, including through litigation, which may affect costs and production, and, in extreme cases, viability of the relevant operation or project.

D.3 Key information on the key risks that are specific to South32 Shares

- South32 Shareholders should be aware that there are risks associated with investment in financial products quoted on a stock exchange. Share price movements could affect the value of any investment in South32.
- The South32 Shares will be quoted in Australian dollars on the ASX, South African rand on the JSE and pounds sterling on the LSE. Dividends in respect of South32 Shares, if any, will be declared in US dollars. Fluctuations in the exchange rate between the US dollar and each of these currencies will affect, among other matters, the local currency value of the South32 Shares and of any dividends.
- The rights of South32 Shareholders are governed by Australian law and may differ from the rights available to shareholders under the laws of South Africa, the United Kingdom or the United States.

SECTION E – OFFER

E.1 Proceeds of the issue/offer

Not applicable. This document does not constitute an offer or invitation to any person to subscribe for or purchase any shares in South32. BHP Billiton and South32 will not receive any proceeds as a result of the Demerger.

E.2a Reasons for the issue/offer and use of proceeds

Not applicable. This document does not constitute an offer or invitation to any person to subscribe for or purchase any shares in South32. South32 will apply for its ordinary shares to be traded on the ASX, JSE and LSE, in connection with the Demerger. South32 will not receive any proceeds as a result of the Demerger.

E.3 Terms and conditions of the offer

Not applicable. This document does not constitute an offer or invitation to any person to subscribe for or purchase any shares in South32.

E.4 Interests material to South32/the offer including conflicting interests

Certain South32 Directors and some of the Independent Competent Persons have shareholding interests in BHP Billiton and will therefore have shareholding interests in South32 immediately following the Demerger. South32 does not consider the interests of the Independent Competent Persons to be sufficiently material to compromise their independence. So far as the South32 Directors are aware, no other person involved in the Demerger has any interest, including conflicting ones, that are material to the Demerger.

E.5 Name of persons offering to sell the securities

Lock-up agreements details, including the parties involved and indication of the period of the lock-up

Not applicable.

E.6 Amount and percentage of immediate dilution resulting from the offer

Not applicable.

E.7 Estimated expenses charged to the investor by South32

Not applicable.

2 RISK FACTORS

In addition to the other information set out in this document, the following risk factors should be carefully considered. The risks and uncertainties described below represent those the South32 Directors consider to be material as at the date of this document. However, these risks and uncertainties are not the only ones facing South32 and the South32 Businesses or relevant to an investment in South32 Shares. Additional risks and uncertainties not presently known to the South32 Directors, or that the South32 Directors currently consider to be immaterial, could also materially and adversely affect the business, results of operations, financial condition and/or prospects of South32. In such case, the market price of the South32 Shares could decline and investors may lose all or part of their investment. Prospective investors in South32 Shares should consider not only the information on key risks summarised in Section 1, but also, among other things, the risks and uncertainties described below.

Many of these are risks to which South32 and the South32 Businesses are already exposed, while others arise or are increased as a result of the Demerger and the ability to take mitigating action may be more limited. Some of these risks may be mitigated by appropriate controls, systems and other actions as further described below, but others will be outside the control of South32 and may not be able to be mitigated.

Investors and prospective investors should consider carefully whether an investment in South32 is a suitable investment in light of the information in this document, their ability to bear risk and the financial resources available to them.

2.1 EXTERNAL RISKS RELATING TO THE INDUSTRIES IN WHICH SOUTH32 OPERATES

(a) Fluctuations in commodity prices and impacts of ongoing global economic volatility may negatively affect South32's results, including cash flows and asset values

The prices South32 obtains for its products are determined by, or linked to, prices in world commodity markets, which have historically been subject to substantial volatility. Commodity prices are affected by underlying global economic and geopolitical factors, industry demand and supply balances, product substitution and national tariffs. In particular, the Chinese market has been a key driver of global materials demand and pricing over the past decade. A slowing in China's economic growth or additional supply has the potential to adversely impact prices for many of South32's products. South32's exposure to a range of commodities and customers operating in different economies, provides a level of diversification to partially protect against this risk.

(b) South32's financial results may be negatively affected by currency exchange rate fluctuations

South32's assets, earnings and cash flows are affected by a wide variety of currencies. The US dollar is the currency in which the majority of South32's sales are determined and its financial results will be reported. Operating costs are influenced by the currencies of those countries where South32 Businesses' mines and processing plants are located and also by those currencies in which the costs of imported equipment and services are determined. The Australian dollar, South African rand, Brazilian real, Colombian peso and US dollar are the most important currencies affecting South32 Businesses' operating costs. Fluctuations in the exchange rates of relevant currencies may impact on South32's financial results.

(c) Actions by governments or political events could have a negative impact on the business

South32 or the South32 Businesses could be adversely affected by new government regulations, such as controls on imports, exports and/or prices. Increasing requirements relating to regulatory and environmental approvals may affect existing operations or potentially cause delays in and adversely affect the expansion of existing operations. South32 could also be adversely affected by changes in fiscal legislation, as South32's operations are based on material long-term investments that are dependent on long-term fiscal stability.

In addition, South32 or the South32 Businesses could be exposed to the risk of terrorism, civil unrest, nationalisation, renegotiation or nullification of existing contracts, leases, permits or other agreements, changes in laws and policy (including changes in exchange control policies regulating the repatriation of earnings or capital out of the relevant jurisdiction) and governmental reviews and investigations (including historical tax audits), as well as other unforeseeable risks in the jurisdictions in which it operates that could have an adverse impact upon the profitability of an operation. In particular, South32 has operations in emerging markets, where such risks are more prevalent.

Potential government actions, reviews or policies that may have specific application to the South32 Businesses are set out below:

- The South African tax policy review by the Davis Commission, the outcomes of which are uncertain and may impact upon the financial results of South32's operations in South Africa.
- The Indonesian Government ban on export of unprocessed aluminium and nickel ores, which affects Chinese alumina and nickel pig iron production, may be reversed at any time with potential changes to global supply balances and the prices South32 receives for some of its products.

- Possible amendments to the Mineral and Petroleum Resources Development Act, which are under consideration by the South African Government through the National Assembly. Furthermore, a review of compliance with the Mining Charter is also currently being undertaken by the Department of Minerals and Energy.
- In Brazil, the Executive Branch submitted to the Brazilian House of Representatives Bill of Law No 5.807/201 which, if and when approved, will replace the existing Mining Code. Among other changes, the proposed bill of law provides for changes in the procedure for the granting of mineral exploration and concession rights, new rules for the calculation of the Financial Compensation for the Exploitation of Mineral Resources (Compensação Financeira pela Exploração de Recursos Minerais, or CFEM) and the assessment of new taxes on mining activities. A new mining regulatory framework may result in limitations on the term of existing mining concessions and in the tender of mining concessions if they are deemed by the Brazilian government to have strategic and economic importance.
- In February 2015, TEMCO was notified of a petition filed with the United States Department of Commerce and the United States International Trade Commission requesting the imposition of antidumping duties on silicomanganese imports of Australian origin (of which TEMCO is the only producer). The petition is being investigated at a preliminary phase by the Department of Commerce and the International Trade Commission and TEMCO intends to co-operate fully in the investigations. TEMCO intends to vigorously contest the claims and strongly defend its position. An adverse outcome could potentially result in the imposition of duties on the sale of TEMCO's product into the United States, which could significantly impact demand for TEMCO's product in that market and, as a result, could impact TEMCO's revenues.

(d) Challenges by administrative bodies, in particular tax authorities, may lead to additional liabilities for South32

Consistent with the general separation principles set out in Section 14.4(b), South32 will assume, and be responsible, for all tax liabilities relating to the South32 Businesses and to the former South32 Businesses, subject to certain exceptions.

Audits and reviews by administrative bodies, in particular tax authorities, may result in South32 incurring additional tax or royalty payments.

Excluding tax exposures that will remain with BHP Billiton, there are certain material claims (or categories of claims) made by tax authorities to which South32 is exposed, which are discussed in further detail below.

In Brazil there are eight separate disputes involving BHP Billiton Metais S.A. (**BMSA**) (a wholly-owned subsidiary of South32), which relate to the payment of Federal and State Value Added Tax, which are currently the subject of proceedings in the Tax Administrative Court. The principal claims relate to non-payment of State Value Added Tax by BMSA on interstate sales of aluminium to customers in the period from 2000 to 2004 and the use of Federal Value Added Tax credits relating to power supply by BMSA. As at the date of this document, the estimated total amount being claimed against BMSA in respect of these eight matters is equal to approximately US\$84 million.

BMSA is also currently disputing an adverse tax assessment in respect of social security contributions in the Tax Administrative Court. The assessment relates to social security contributions not paid by BMSA during 2004 to 2007. BMSA's position that social security contributions in respect of this period are not payable is based on a 1992 Federal Regional Court decision exempting BMSA from payment of the contributions on the basis that the tax was unconstitutional. The Supreme Court subsequently decided in favour of the constitutionality of the tax in 2007. BMSA contests that the Supreme Court's decision should not apply where a previous judicial decision has exempted payment of the contributions, such as the exemption provided to BMSA pursuant to the Federal Regional Court's decision in 1992. As at the date of this document, the amount claimed in respect of this matter is equal to approximately US\$105 million.

Cerro Matoso SA (**CMSA**) (a 99.94 per cent owned subsidiary of South32) is disputing an adverse assessment by the Colombian Revenue Service made in July 2014 concerning the non-taxation of revenue sales and deductibility of certain costs. The likely timing of the resolution of this matter is currently uncertain. As at the date of this document, the amount claimed in respect of this matter is equal to US\$60 million.

South Africa Energy Coal is disputing an adverse assessment by the South African Revenue Service made in September 2013 concerning the purchase price allocation for a sale of assets that occurred in 2008. The likely timing of the resolution of this matter is currently uncertain. As at the date of this document, the amount claimed in respect of this matter is equal to approximately US\$53 million.

Certain other tax-related claims have been made in respect of the South32 Businesses, which are separate and none of which is considered to be individually material but aggregate to a total of US\$149 million. These comprise tax claims relating to corporate income tax credits and offsets in Brazil and underpayment of royalties and income tax payment shortfalls and certain other matters have been claimed against South32 Businesses in Colombia.

In each of these cases, South32 intends to continue to vigorously contest the matter. While South32 believes that some of these claims may take many years to be resolved, if there is an adverse finding against South32 in these matters it may result in material liabilities for, or reduce future profitability of, South32.

Where South32 considers a claim may result in probable loss, it is reflected in a provision in South32's balance sheet. Where South32 considers that a claim has a lower probability of resulting in loss, South32's exposure may be reflected in a contingent liability disclosure in South32's financial statements (set out in Section 10.8(d) and note 18 Contingent liabilities to the historical combined financial information set out in Annexure 1).

Given the uncertainty in respect of claims of this nature from tax authorities, and South32's view that it is confident that an outcome favourable to South32 will be achieved in most of these cases, the provisions and contingent liabilities in South32's financial statements do not cover all of, and may not adequately capture, South32's total potential liability in respect of these and similar claims. As a result, the ultimate exposure South32 faces for claims may be greater than that provided for in South32's financial statements or included in its contingent liabilities.

(e) South32's operations are dependent on licences and permits, the obtaining, renewal or maintenance of which may be uncertain or challenging

South32 Businesses generally require governmental licences, permits, authorisations, concessions and other approvals in connection with their activities. Obtaining and complying with the necessary governmental permits and regulations can be particularly complex, costly and time-consuming and are therefore not assured.

The duration, cost and success of permit applications are contingent on many factors, including those outside the control of the South32 Group. Failure to obtain or renew a necessary permit could mean that South32 Businesses would be unable to proceed with the development or continued operation of a mine or project, which in turn may have an adverse effect on the relevant South32 Businesses, results of operations, financial condition or prospects. The permits that South32 Businesses need may not be issued, maintained or renewed either in a timely fashion or at all, which may constrain the ability of South32 Businesses to conduct their mining operations, which in turn may impact South32's financial results.

From time to time, parties may seek to challenge the validity of permits and licences or attempt to interfere with rights granted to South32 Businesses. This may result in the loss of rights held by, or the incurrence of additional cost to, South32 Businesses.

(f) South32 may be exposed to litigation and claims that could result in a significant cost to South32 or affect its operations

South32 is exposed to risks of litigation that may have an adverse effect on South32. There are some actions and claims that have been raised by third parties that are yet to be resolved. South32 may lose such claims and may incur costs in addressing such claims.

CMSA and certain Colombian Government agencies are defendants to proceedings in the Colombian Constitutional Court. The proceedings involve a review of multiple claims that are similar in nature brought by representatives of local communities. The claims, which CMSA and the defendant Government Agencies strongly contest, allege that Amendment No. 4 to Contract 051-96M (which set forth revised conditions for the continued operation of CMSA under its key mining licence in 2012) is not valid on the basis that local communities should have been consulted about the amendment, that CMSA's environmental licence expired when the concessions under which CMSA operated until 30 September 2012 expired (notwithstanding that the environmental licence was issued for the term of the project and the project continues under Contract 051-96M) and that CMSA's operations are impacting the health of the neighbouring communities. First and second instance judgments in respect of one of these actions and a first instance judgment in respect of the other action were issued against the plaintiffs in 2013 and early 2014. The Constitutional Court is now conducting a review of these judgments, with submission of evidence and arguments in the proceedings continuing. A decision in respect of this matter is expected in 2015. An adverse outcome could result in a court order for the temporary suspension or revocation of CMSA's mining or environmental licences, require CMSA to modify its operations to address the alleged health and environmental impacts or require CMSA to undertake a retrospective community consultation process in relation to Amendment No. 4 under the supervision of the Ministry of the Interior.

A separate action has been brought in respect of the privatisation process conducted for Cerro Matoso. The relief sought is the annulment of the sale of a shareholding of approximately 47.6 per cent in CMSA to BHP Billiton Group (BVI) Limited in 1997 (which, if successful, would require the Colombian Government to reimburse the South32 subsidiary for the amount it paid for the shareholding and to reimburse CMSA for investments made in the Cerro Matoso project after 1997 that have not been amortised as at the date of the judgment). At first instance, a decision was issued by a Civil Judge in favour of CMSA and the other defendants. However, an appeal of the decision at first instance decided that the Colombian administrative courts (which are responsible for considering actions involving government-related law suits) have the appropriate jurisdiction in respect of the matter. An action was therefore commenced in the Council of State (Colombia's highest administrative court dealing with government-related law suits). The basis for the claim has not been stated, the proceedings have not progressed since this action was commenced in October 2008 and notice of the action has not been formally served upon BHP Billiton Group (BVI) Limited, the relevant South32 subsidiary.

Illawarra Metallurgical Coal has a long term contract with BlueScope Steel for the supply of metallurgical coal to BlueScope Steel's steelworks located at Port Kembla. BlueScope Steel has made certain claims in relation to the calculation of historical prices under the contract, and in relation to the quality of coal supplied under the contract. Illawarra Metallurgical Coal does not accept the claims made by BlueScope Steel, and a dispute resolution process to resolve these claims has recently commenced.

In each of the cases above, South32 intends to continue to strongly contest the matter. However, if there is an adverse finding it may result in liability for, and/or reduce the future profitability of, South32.

There are also other litigation and arbitration proceedings to which South32 Businesses are exposed, but which are not regarded as material by South32. However, it is possible that South32's assessment of its exposure in respect of these proceedings may change in the future, including as a result of developments in the proceedings or additional information becoming available.

2.2 OPERATIONAL RISKS

(a) Cost pressures and reduced productivity could negatively impact South32's operating margins and expansion plans

Cost pressures may occur across industries to which South32 Businesses are exposed and affect a variety of inputs into South32's operations, which would negatively impact South32's operating margins.

Labour is a significant input into South32's operations, and labour costs may vary depending on demand and requirements at South32's operations. Labour costs and productivity may also be affected by the actions of labour unions, which may adversely affect workplace flexibility, productivity and costs.

Increased costs of energy and other raw materials used by South32 may also adversely affect South32's earnings.

(b) South32 Businesses are dependent on access to infrastructure that is economical, and without such access these operations may be disrupted or further development may be prevented

South32 Businesses' products are transported to customers by a range of methods, including road, rail and sea. A number of factors could disrupt the availability of these transport services, including weather-related problems, rail or port capacity and allocation constraints, key equipment and infrastructure failures and industrial action, which may limit South32 Businesses' ability to deliver product to customers and may have an impact on productivity and profitability. Furthermore, the cost of accessing required infrastructure may increase (possibly substantially), and South32 Businesses may not be able to pass on the full extent of that cost increase to its customers.

In South Africa, South32 Businesses' access to the rail infrastructure of Transnet (the South African Government-owned rail freight and port provider) is key to its operations. South Africa Manganese and South Africa Energy Coal currently have allocations to access Transnet's rail infrastructure; however, securing future access when current allocations expire (and the terms on which that access may be secured) is uncertain due to capacity constraints and the level of demand from third parties. Transnet has recently allocated volumes for the next five years for manganese export capacity (final terms are still under discussion). The ability of South32 Businesses to develop and expand operations, particularly in South Africa, is impacted by South32's access to infrastructure to support increased output.

(c) South32 Businesses are dependent on access to water and power that is economical, and without such access these operations may be disrupted or further development may be prevented

Water and power are critical to a number of South32's operations. However, continued access, or access on current terms, to water and electricity to support existing activities cannot be guaranteed in the future, due to factors such as climate (including drought), changes in allocations, changes in activities or conditions at South32's operations, elections by contract counterparties to cease current arrangements, the term of contractual arrangements ending or changes in government policy.

The cost and reliability of power supply are risks to the financial position and operations of South32's aluminium smelters, particularly South Africa Aluminium and Mozal Aluminium. Due to ongoing power shortages and reliability issues in the South African power grid, South Africa Aluminium and Mozal Aluminium are, at times, subject to load shedding. In recent years the reliability of electricity supply in South Africa has further deteriorated and the frequency of load shedding has increased. Eskom, the South African Government-owned power utility, announced a national program of load shedding in January 2015 and has stated that the South African power system is likely to be constrained for the foreseeable future. A temporary increase in the electricity levy has been proposed until the electricity shortage is over. Interruptions to the supply of power to South32's aluminium smelters can result in production losses and damage to plant. More generally, the lack of reliability, and potential increases in the cost, of power supply could significantly affect operations at South Africa Aluminium and Mozal Aluminium for an extended period of time. In addition, Eskom referred the power pricing regime for South Africa Aluminium's power supply contracts to the National Energy Regulator of South Africa for review in October 2012.

Current levels of hydro-generation power plants' water reservoirs in Brazil have increased the risk of electricity rationing occurring. Should electricity rationing occur, the performance and profitability and ongoing operations of the Alumar Smelter could be adversely impacted.

Furthermore, expansion and development of activities of South32 Businesses may be subject to the ability to access sufficient water and power on economic terms. A failure to procure supplies of water and power, or access to water and power infrastructure on economically acceptable terms, could limit the ability of South32 Businesses to expand activities or develop new operations.

(d) Unexpected natural or operational catastrophes may adversely impact South32's operations

Members of the South32 Group have extractive, processing and logistical operations in a number of geographic locations. South32's operations may be subject to accidents or incidents that impact the ability of South32 Businesses to continue operating or cause harm to its assets or equipment.

In particular, South32 Businesses access key port facilities located at Richards Bay in South Africa and Bunbury, Milner Bay, Bell Bay, Townsville and Port Kembla in Australia, together with key rail facilities located at Richards Bay and Bunbury. This port and rail infrastructure may be subject to port, shipping or rail incidents that could temporarily or permanently restrict access.

South32 Businesses include six underground mines, including four underground coal mines. Mines, particularly underground mines, and associated mining and processing equipment and processing plants can be exposed to incidents such as fire and explosion, loss of power supply and critical mechanical equipment failures. South32 may also be exposed to other incidents that affect operations, including pit wall failures at open-cut mines.

South32's operations may also be subject to unexpected natural catastrophes such as earthquakes, floods, hurricanes and fires. The mine and processing facility at Cannington is located between the confluence of two ephemeral watercourses at the headwaters of the Lake Eyre Basin catchment, and, if flooding were to occur, this could have adverse implications on the operations.

Existing business continuity plans may not provide full protection for all of the costs that arise from such events. The impact of these events could lead to disruptions in production, increased costs and/or loss of facilities, which would adversely affect South32's financial results and prospects. Third party claims arising from these events may also exceed the limit of liability in the insurance policies South32 has in place in respect of such events.

(e) South32 is reliant on non-controlled operators and contractors at some operations

South32 does not control (or solely control) all aspects of each of the South32 Businesses. The Brazil Aluminium assets (MRN and Alumar) are managed by joint venture partners, limiting the level of decision-making power South32 has in respect of these assets. Other South32 Businesses or assets may, in the future, also be managed by joint venture partners. These non-controlled assets may not comply with South32's management and operating standards, controls and procedures, including its health, safety, environment and community (**HSEC**) standards. Failure to adopt equivalent standards, controls and procedures at these assets could adversely impact South32's reputation and financial results.

South32 is also reliant on the use of contractors and other third parties for exploration, mining and other activities. While the situation is normal practice for the mining and exploration industry and South32 seeks to actively manage these contractors to achieve desired performance levels, to some extent South32 relies on these contractors performing their roles properly and their failure to do so may impact the performance of South32.

(f) Outputs produced from processing are dependent on quality and consistent supply of inputs

Some of South32's activities rely on the processing of raw materials, including some raw materials supplied from South32's own mines, the quality of which is not always consistent. In these activities, the quality and quantity of output, cost of processing and/or time taken to process raw materials may be affected by the quality of raw material supplied and the consistency of supply of inputs, which may in turn impact the financial results achieved by South32.

The grade of minerals produced from mining operations often diminishes over the life of a mine, resulting in lower quality products being produced from mining operations in their later stages.

(g) South32's operations may be affected by unfavourable employee and union relations, which could disrupt its activities

Some of the employees at South32 Businesses are represented by labour unions under various collective labour agreements.

Parts of South32's workforce in certain locations, including Australia, Colombia and South Africa, are members of unions. The South32 Businesses may not be able to satisfactorily renegotiate collective labour agreements when they expire and may face higher wages and changes in benefits.

In addition, existing labour agreements may not prevent strikes or work stoppages in the future, and any strike or other work stoppage could have an adverse effect on the operations and financial results of the South32 Businesses.

(h) Due to the nature of its business and operations, South32 is exposed to the risks of fraud and corruption

As a diversified metals and mining company operating in a number of jurisdictions, South32 is exposed to the risks of fraud and corruption, both within its organisation and in dealing with parties external to the organisation. Some of South32's activities are located in countries where corruption is generally understood to exist.

South32 will seek to fully comply with applicable legislative and regulatory requirements in respect of fraud and corruption in the jurisdictions in which it operates. South32 will also seek to implement internal control systems to limit the occurrence of fraud or corruption. However, there can be no assurance that such procedures and established internal controls will adequately protect South32 against fraudulent or corrupt activity and such activity could have an adverse effect on South32's business, reputation, results of operations, financial condition or prospects. In addition, South32 may suffer from delays or disruption resulting from a refusal to make so-called facilitation payments in some of the countries in which South32 operates.

BHP Billiton's policies on financial sanctions and competition law are currently applicable to South32. Prior to implementation of the Demerger, South32 will establish policies or controls to address trade and financial sanctions and competition law. However, such policies and controls may not prevent instances of dishonesty by employees, contractors or third parties nor guarantee compliance with legal or regulatory requirements. This may lead to regulatory fines, disgorgement of profits, litigation, loss of operating licences or reputational damage.

(i) South32 will be smaller in scale than BHP Billiton following the Demerger

Following the Demerger, South32 will be an independent entity and much smaller in scale than BHP Billiton. This may result in South32 facing additional costs or risks compared to the position historically, including reduced access to, and less favourable terms in, any future financing facilities and different terms on which it procures goods or services.

(j) The Demerger may fail to realise anticipated benefits for South32

South32 may fail to realise any or all of the anticipated benefits of the Demerger, either in a timely manner or at all. Some of the potential benefits of the Demerger may not be achieved as a result of circumstances outside the control of South32.

(k) Third party consents required as part of the Demerger may not be obtained

The Demerger (or steps associated with the Demerger) may result in breaches or defaults under certain contracts to which South32 is a party, unless relevant counterparty consents are obtained. In addition, there are certain BHP Billiton Group-wide contracts relevant to South32's operations, which BHP Billiton is seeking to assign to South32 or renegotiate so that there are separate contracts for South32 and BHP Billiton.

Although all material contractual consents required to effect the Demerger have been obtained, there are a number of less material consents that have not been obtained as at the date of this document. BHP Billiton has started seeking these consents, but not all counterparties may provide consent (and some counterparties may seek to alter the terms of the relevant contract, as a condition of providing consent). A failure to obtain these consents may result in breaches or defaults under contracts, or an inability to align contractual arrangements to South32 and BHP Billiton as independent entities.

(l) There is potential for delays, unexpected costs or other issues in establishing South32 as a standalone legal entity

As a subsidiary of BHP Billiton prior to the Demerger, South32 has been supported by BHP Billiton's corporate services infrastructure, including the provision of services relating to group accounting, treasury, tax, superannuation, legal, insurance administration, information management and information technology, certain group purchasing and general human resources.

As part of the implementation of the Demerger, South32 will replace these support services with its own internal capability, third party contracts and transitional service agreements as appropriate. During a transitional period of up to 12 months, South32 will be reliant on BHP Billiton for the provision of certain information management-related services.

It may take some time to procure the necessary resources and services and ensure that all processes are operating fully and efficiently. There is a risk that the establishment of these capabilities may take longer than expected or may involve greater costs than anticipated.

(m) Breaches of South32's information technology security processes may adversely impact South32's business activities

South32 will acquire or develop and maintain, or source from other parties, global information technology systems, consisting of infrastructure, applications and communications networks to support South32's business activities. These systems could be subject to security breaches (for example cyber-crime) resulting in theft, disclosure or corruption of information, including information relating to acquisitions and divestments, strategic decision-making, non-public investment market communications or commercially sensitive information relating to major contracts. Security breaches could also result in misappropriation of funds or disruptions to South32's operations.

(n) Failure to retain and attract key employees to South32 may impact on operations and financial results

The loss of key personnel or the failure to attract, train and recruit sufficiently qualified staff could affect South32's operations, financial condition and growth.

Furthermore, BHP Billiton employees may not accept employment offered by South32 as part of the Demerger, resulting in South32 not retaining the benefit of employees with specialist knowledge of their functions.

2.3 BUSINESS RISKS

(a) Failure to maintain, realise or enhance existing reserves, discover new reserves or develop new operations could negatively affect South32's future results and financial condition

The volume and quality of product the South32 Businesses recover may be less than South32 or Competent Persons have estimated. Mineral Resource and Ore Reserve estimates are expressions of judgement based on knowledge, experience and industry practice. There are risks associated with such estimates, including that the ore mined may be of a different grade, tonnage or strip ratio from those in the estimates. Mineral Resource and Ore Reserve estimates also depend to some extent on interpretations and geological assumptions, commodity prices, cost assumptions and statistical inferences, which may ultimately prove to have been unreliable.

Consequently, Ore Reserve and Mineral Resource estimates are often regularly revised based on actual production experience or new information and could therefore be subject to change.

Moreover, a decline in the price of commodities that South32 Businesses sell, reduction in recovery rates or ore grades or changes in applicable laws and regulations, including environment, permitting, title or tax regulations, that are adverse to South32, may mean the volumes of product that South32 can feasibly extract may be lower than the Ore Reserve estimates, which may result in a reduction of such estimates.

Furthermore, production from South32's operations results in existing reserves being depleted over time. A failure to discover new reserves, enhance existing reserves or develop new operations in sufficient quantities to maintain or grow the current level of its reserves could negatively affect South32's results or prospects.

The discovery of new mineral deposits does not guarantee that the mining of that deposit would be commercially viable; the size of the deposit, location, access to infrastructure, development and operating costs, commodity prices and recovery rates are all key factors in determining commercial viability. Furthermore, local communities in close proximity to new proposed operations may create additional costs or delays in respect of, or ultimately prevent the commencement or continuation of, those operations.

(b) Increased costs or schedule delays may adversely affect South32's development projects

While significant time and resources have been devoted to project planning, approval and review processes, many of the development projects of South32 Businesses are highly complex and rely on factors that are outside its control, which may result in South32 underestimating the cost or time required to complete a project. In addition, South32 Businesses may fail to manage projects as effectively as anticipated or unforeseen challenges may emerge. Furthermore, the cost of inputs into the development of projects may rise over time or be volatile, making development less economically rewarding.

Increased capital costs or schedule delays at development projects of South32 Businesses will adversely affect such future development projects and impact anticipated financial returns.

2.4 FINANCIAL RISKS

(a) If South32's liquidity and cash flow deteriorate, it could adversely affect South32's access to capital and ability to operate existing assets or fund major capital programs

South32 will target an investment grade credit rating throughout the cycle. However, fluctuations in commodity prices and the ongoing global economic volatility may adversely impact South32's future cash flows. If South32's key financial ratios are not maintained and an investment grade credit rating is not obtained or maintained, its liquidity and cash reserves, interest rate costs on borrowed debt and future access to financial capital markets could be adversely affected.

(b) Closure and rehabilitation costs require significant judgements and estimates and are therefore subject to change

Closure planning is a key consideration in the planning and development of South32's projects and operations. All operations are required to develop and maintain closure plans, which describe the proposed methods to rehabilitate disturbed land and remediation requirements for contaminated land, and end uses for land and infrastructure.

South32 is required in its financial statements to include provisions for the expected closure and rehabilitation costs of its operations. Those provisions are measured at the expected future cash flows, discounted to their present value and determined according to the probability of alternative estimates of cash flows occurring for each operation. Significant judgements and estimates are involved in forming expectations as to future activities and the amount and timing of future cash flows, having regard to factors such as requirements of the relevant legal and regulatory framework, the magnitude of possible contamination, and the timing, extent and costs of required closure and rehabilitation activity.

South32 and its management consider its closure and rehabilitation provisions to be appropriate based on currently available information (including estimated closure dates). However, given inherent uncertainties, the future actual expenditure may differ from the amounts currently provided.

(c) South32 may not recover its investments in mining assets, which may require financial write-downs

One or more of the South32 Businesses may be affected by changed market or industry structures, commodity prices, technical operating difficulties, inability to recover its Ore Reserves or increased operating cost levels. These may cause South32 to fail to recover all or a portion of its investment in mining assets and may require financial write-downs, adversely impacting financial results.

(d) The commercial counterparties the South32 Businesses transact with may not meet their obligations, which may negatively impact South32's financial condition and results

The South32 Group contracts with a number of commercial, governmental and financial counterparties, including customers, suppliers and financial institutions. Counterparties may fail to perform against existing contracts and obligations. Non-supply or changes to the terms of supply of key inputs, such as tyres, mining and mobile equipment and other key consumables, may unfavourably impact costs and production at South32's operations. Furthermore, South32 will need to replace certain services provided under transitional service arrangements entered into with BHP Billiton with agreements with third parties, creating the risk of counterparties failing to meet performance standards that were achieved prior to the Demerger or under transitional services provided by BHP Billiton. These factors could negatively affect South32's Businesses and there can be no assurance that South32 would be successful in attempting to enforce any of its contractual rights through legal action.

(e) South32 may be subject to restrictions on its ability to pay dividends or extract capital out of certain jurisdictions

South32's ability to pay dividends will depend on, among other things, government regulation, the level of distributions, if any, received from South32's operating subsidiaries and associates, and their level of cash balances and access to those cash balances.

Certain of South32's operating subsidiaries may, from time to time, be subject to restrictions on their ability to make distributions to South32 or return cash to it by other means, and there can be no assurance that such restrictions will not have an adverse effect on the market price of South32 Shares.

It is a condition of SARB's approval of South32's inward listing on the JSE, that South32 will have the right to pay dividends from its South African subsidiaries and to remit any such dividends abroad without having to obtain the prior written consent of the FinSurv Department, provided that the payout ratio of dividends from the distributable reserves of the South African subsidiaries shall be no greater than the average payout ratio of dividends from the distributable reserves of non-South African subsidiaries.

(f) South32's insurance coverage may be inadequate to respond to significant events, causing disruptions to its activities or financial loss

South32's insurance coverage with respect to its operations may be inadequate and the occurrence of an event could adversely affect the South32 Businesses, including its operations, financial condition and results or prospects. In addition, South32 may incur liabilities to third parties (in excess of any insurance cover or statutory reserves) arising from negative environmental impacts or other damage or injury.

2.5 SUSTAINABILITY RISKS

(a) Impacts, incidents or accidents and related regulations may adversely affect South32's people, operations, reputation or licence to operate or the environment

There are a number of risks that could adversely affect South32's people, operations, reputation or licence to operate or the environment.

(1) South32 may be adversely affected by health and safety risks in respect of its activities

Health-related risks at South32's operations include potential occupational exposure to noise, manganese, carcinogenic substances, such as silica, diesel particulate matter, nickel, sulphuric acid mist, flourides and coal tar pitch. Longer-term health impacts may arise due to the exposure of the South32 workforce to these and other hazardous substances. The South32 Businesses have, and have had for a number of years, in place comprehensive health and safety policies and performance requirements that are intended to help mitigate the impact of such exposures.

Risks to fitness-for-work, such as fatigue and impairment from illegal or legal drugs, including alcohol, may also affect South32's operations. South32 Businesses operated by members of the South32 Group are required to develop and implement a fatigue management plan and a risk-based drug and alcohol program. Infectious diseases such as HIV and malaria may also have an adverse impact upon South32's workers or on its communities, primarily in Africa. Because South32 operates internationally, it may be affected by potential pandemic outbreaks.

South32 has controls in place to understand, manage and, where possible, eliminate the safety risks in its business. Potential safety events that may have an adverse impact on South32's operations include fire, explosion or rock fall incidents both in above ground and underground mining operations, personnel

conveyance equipment failures or human errors in underground operations, aircraft incidents, incidents involving light vehicles and mining mobile equipment, ground control failures or gas leaks, equipment isolation during repair and maintenance, working from heights or lifting operations.

Fatal injuries have historically occurred at South32 Businesses' sites and there is a risk of future fatalities. These incidents may result in claims or criminal prosecutions against South32 Businesses.

South32's approach to health and safety is reflected in its controls and procedures, which are intended to eliminate risk wherever possible. However, there can be no assurance that these controls and procedures will always fully protect against these potential future risks.

(2) South32 may be adversely affected by environmental risks in respect of its activities

South32's operations, by their nature, have the potential to impact biodiversity, land, water resources and related ecosystems, including from the discharge of contaminants. Changes in scientific understanding of these impacts, regulatory requirements or stakeholder expectations may prevent or delay project approvals and result in increased costs for mitigation, offsets or compensatory actions.

All of South32's operating and closed facilities are required to have comprehensive closure plans in place, which include the proposed methods to rehabilitate disturbed land and remediation requirements for contaminated land, and end uses for land and infrastructure. Changes in circumstances and regulatory or community expectations may result in closure plans requiring change. Furthermore, challenges may be faced in implementing existing closure plans or amendments may be required to closure plans to address new circumstances that come to light or to ensure appropriate rehabilitation and remediation of sites. These factors may impact financial closure provisions and costs at the affected operations.

South32's operations (particularly South Africa Energy Coal) include a number of closed mines and facilities. Implementation of the closure plans for the South Witbank colliery (which is a former operation of South Africa Energy Coal that closed in 1975) remains subject to ongoing review having regard to structural risks relating to the surface area of the former mine (where some sink-holes have formed) and the long-term risk of underground fires spreading from nearby mines owned by third parties.

Incidents that may occur or may have historically occurred at South32's operations may have an adverse environmental impact, including from uncontrolled tailings containment breaches, escape of polluting substances and subsidence from mining activities, (particularly at South32's underground mines, including Illawarra Metallurgical Coal, which has the potential to cause damage to adjacent infrastructure). Certain of South32 Businesses' sites are subject to remediation plans that seek to address known contamination as a result of past activities. Remediation plans for these sites are subject to ongoing review and change, including as a result of engagement with regulatory authorities, landowners and local communities. Changes to the remediation plan may have an impact on the closure provision. Furthermore, as yet undiscovered contamination may be identified or future contamination may occur that requires remediation action that could result in additional costs for South32.

Diesel in ground water has been identified at GEMCO's Milner Bay port facility. The contamination is currently contained and discussions with local landowners and regulators as to the final rehabilitation plan for the contaminated area are ongoing. If this results in any changes to the closure plan or assumptions underlying the current provision, it is possible that the provision for this event will need to change.

(3) Water and waste water management risks have the potential to adversely impact the sustainability of South32's operations

South32 is strongly focused on water and waste water management, as the sustainability of South32's operations relies on South32's ability to obtain an appropriate quality and quantity of water, use it responsibly and manage it appropriately, including taking account of natural supply variations.

South32's operations are exposed to a range of water risks, including water scarcity, water excess, water quality, water discharge or discharge into ground water issues. Some assets are more prone than others to these water management related risks.

Worsley Alumina has implemented a number of projects to address water management risks, including to control, monitor and assign accountability for all aspects of residue management and to improve liquor return to the refinery, reduce additional water use and minimise dust emissions. Contaminated water from Worsley Alumina's operations is stored in site containment facilities from which contaminated water could be released if higher than average rainfall or extreme weather occurs. South32 is considering various mitigation strategies to address this risk.

(4) South32 Businesses may be disrupted without the support of the local communities in which the South32 Businesses are located

Notwithstanding South32's contributions to the communities in which the South32 Businesses are located, local communities may become dissatisfied with the impact of South32's operations or oppose new development projects, including through litigation, which may affect the costs, production, and, in extreme cases, viability of such operations. Community-related risks may include community protests or civil unrest, delays to proposed developments, mistreatment of local communities by South32 employees or contractors and inadvertent breaches of human rights or other international laws or conventions.

In CY2013, Cerro Matoso faced a community incident relating to a protest by local communities. Following on from this incident, agreement has been reached with the communities regarding the provision of community support and the establishment of a regular forum to engage with the communities located close to Cerro Matoso to better facilitate the resolution of concerns and complaints at an early stage. There remains a risk of community incidents occurring at Cerro Matoso or any other South32 Businesses.

There are also security risks that may impact on South32's operations and people. This security risk includes the prospect of unpredictable actions, such as violence, that may be taken by illegal miners discovered at certain mines, including South Africa Manganese.

(b) Climate change and greenhouse gas effects may adversely impact South32's operations and markets

The South32 Businesses have significant sales of carbon-based energy products. Carbon-based energy is also a significant input in a number of South32's mining and processing operations.

A number of governments and governmental bodies have introduced, or are contemplating introducing, fiscal and/or regulatory change to address the impacts of climate change. Many countries have established, or are contemplating establishing, individual greenhouse gas targets and/or other national mitigation actions.

The South African National Treasury published its Revised Carbon Tax Policy Paper in May 2013 that sets out the South African Government's intention to introduce a carbon tax. The South African Government has proposed a phased implementation of the carbon tax, phase one of which is scheduled to commence on 1 January 2016. Uncertainty exists around the final form of the tax and whether the tax will actually be implemented.

There is a potential gap between the current valuation of fossil fuel reserves on the balance sheets of companies and in global equities markets and the reduced value that could result if a significant proportion of reserves were rendered incapable of extraction in an economically viable fashion due to regulatory or market responses to climate change.

Furthermore, there is the potential impact on South32's financial results of increased input costs caused by measures taken by governments in respect of the use of carbon-based energy. Certain South32 smelting and refining assets are particularly prone to this risk, given they are significant users of electricity produced from coal and natural gas.

The physical impacts of climate change on South32's operations are uncertain and will be specific to the geographic circumstances. These may include changes in rainfall patterns, water shortages, rising sea levels, increased storm intensities or higher temperatures. These effects may adversely impact the productivity and financial performance of South32's operations.

Recently, there has also been activism by certain parties against companies with significant exposures to fossil fuels. Given South32's commodity profile, South32 may be the target of such activism, which could lead to investors being encouraged not to invest in, or to divest their interests in, South32 or other actions being taken that would impact South32's operations, results or share price.

2.6 GENERAL RISKS RELATING TO THE SOUTH32 SHARES

(a) The price of South32 Shares may be subject to broader share market conditions

South32 Shareholders should be aware that there are risks associated with an investment in financial products quoted on a stock exchange. Share price movements could affect the value of any investment in South32.

The value of South32 Shares can be expected to fluctuate depending on various factors, including fluctuations in the domestic and international markets for listed stocks, general worldwide economic conditions, changes in government policies, investor perceptions, movements in interest rates, prices of South32's products, variations in operating costs and costs of replacing capital assets which South32 may require in the future.

In addition, following the Demerger, some BHP Billiton Shareholders may not wish to hold South32 Shares (or may not be permitted to do so under the terms of their investment mandates, including because South32 will not qualify for inclusion in FTSE indices), and may sell the South32 Shares they received under the Demerger. Sales of this sort could create short term selling pressure on the South32 Shares. The sale of South32 Shares by the Sale Agent may also impact the trading price of South32 Shares.

However, it is expected that 100 per cent of the South32 Shares will qualify for inclusion in the S&P/ASX indices, although not all of the South32 Shares will initially be distributed to investors whose portfolios are benchmarked against those indices (as a proportion of South32 Shares will be distributed to shareholders in BHP Billiton Plc). This means that the allocation of shares to shareholders who benchmark their portfolios against the S&P/ASX indices may be less than would be required for them to initially achieve an equivalent portfolio exposure to that benchmark, creating a relative underexposure to South32 in their portfolios. It is reasonable to expect that this underexposure may give rise to demand for South32 Shares, as would demand from shareholders who wish to increase their exposure to South32 for any other reason.

(b) Future share issues by South32 may dilute existing South32 Shareholders or cause volatility in the price of South32 Shares

The issue of additional shares by South32 or the possibility of such issue may cause the market price of South32 Shares to fluctuate, decline or be lower than might otherwise be the case or result in the dilution of the interests of South32 Shareholders. In addition, future share issues conducted by South32 may adversely affect South32's ability to raise capital in the future or dilute interests of South32 Shareholders.

(c) Exchange rate fluctuations may adversely affect the foreign currency value of South32 Shares and any dividend

The South32 Shares will be quoted in Australian dollars on the ASX, South African rand on the JSE and pounds sterling on the LSE. Dividends in respect of South32 Shares, if any, will be declared in US dollars. Fluctuations in the exchange rate between the US dollar and each of these currencies will affect, among other matters, the local currency value of the South32 Shares and of any dividends.

(d) The rights afforded to South32 Shareholders are governed by Australian law. Not all rights available to shareholders under the laws of South Africa, the United Kingdom and the United States will be available to South32 Shareholders

The rights afforded to South32 Shareholders will be governed by Australian law, and these rights differ in certain respects from the rights of shareholders in typical South African, English and United States companies (or companies incorporated in any other jurisdictions).

Under English law, generally speaking, directors may allot shares if authorised to do so by ordinary resolution of the company's members or by the articles of association. In addition, shareholders have pre-emption rights unless those rights are explicitly excluded or disapplied. This means that an issue for cash of equity securities or rights to subscribe for, or convert into, equity securities must be offered in the first instance to the existing equity shareholders in proportion to the respective nominal values of their holdings, unless a special resolution has been passed at a general meeting of shareholders to the contrary. However, South32 will not be subject to the requirements of the Companies Act 2006 to obtain authority from shareholders to allot new shares and to issue equity securities otherwise than on a pre-emptive basis to existing holders of ordinary shares. Any future increase in South32's share capital or granting of rights to subscribe for South32 Shares may be dilutive to South32 Shareholders as they do not have pre-emption rights under the South32 Constitution or Australian law (although shareholders are afforded certain protections against dilution pursuant to the ASX Listing Rules and Corporations Act).

(e) Foreign investors may find it difficult to enforce foreign judgements obtained against South32 and the South32 Directors

The majority of the South32 Directors and officers reside outside South Africa and the United Kingdom. In addition, South32's assets are located in various jurisdictions. As a result, it may not be possible for non-Australian investors to effect service of process on or to enforce judgements obtained against South32, or its directors or officers, in respect of actions commenced in the investor's home jurisdiction.

This page has been intentionally left blank.

3 IMPORTANT INFORMATION

3.1 GENERAL

The contents of this document are not to be construed as legal, business or tax advice. Each prospective investor should consult their own lawyer, financial adviser or tax adviser for legal, financial or tax advice.

The contents of the BHP Billiton website (www.bhpbilliton.com) do not form part of this document and South32 Shareholders and prospective investors should not rely on them. Furthermore, neither BHP Billiton nor South32 does not accept any responsibility for the accuracy or completeness of any information reported by the press or other media, or the fairness or appropriateness of any forecasts, views or opinions expressed by the press or other media regarding the Demerger, BHP Billiton or South32. Neither BHP Billiton nor South32 make any representation as to the appropriateness, accuracy, completeness or reliability of any such information or publication.

Without prejudice to any obligation of South32 to publish supplementary disclosure pursuant to Section 87G of FSMA and PR 3.4.1 of the UKLA Prospectus Rules, neither the publication of this document nor any distribution of South32 Shares shall, under any circumstances, create any implication that there has been no change in the business or affairs of the South32 Group taken as a whole since the date of this document or that the information contained herein is correct as of any time subsequent to its date.

3.2 PREPARATION OF, AND RESPONSIBILITY FOR, THIS DOCUMENT

- South32 and the South32 Directors, whose names appear in Section 8.1(a), accept responsibility for the information contained in this document (the liability of South32 and the South32 Directors being subject to certain indemnities BHP Billiton Limited has agreed to provide to South32, as described in Section 14.4).
BHP Billiton Limited accepts responsibility for the information contained in this document save for the information contained in Sections 5.2, 5.3, 5.5, 7.7, 8.1 to 8.6 and 8.8 (as well as information included in other sections of this Document which substantially replicates, derives from or summarises the information referred to in these sections).
To the knowledge of South32, BHP Billiton Limited and the South32 Directors (who have taken all reasonable care to ensure that such is the case), the information contained in this document is in accordance with the facts and contains no omission likely to affect the import of such information.
- KPMG Financial Advisory Services (Australia) Pty Ltd (**KPMG Transaction Services**) has given, and has not withdrawn, its written consent to be named in this document as Independent Accountant to the South32 Group in relation to the pro forma historical financial information in the form and context in which it is named and the inclusion in this document of its report in Section 12 (Independent Accountant's Assurance Report) in the form and context in which it is included. KPMG Transaction Services has authorised the contents of such report for the purpose of PR 5.5.3R(2)(f) of the UKLA Prospectus Rules.
- KPMG and KPMG Inc have given and have not withdrawn their written consent to be named in this document as Auditor to the South32 Group in relation to the historical combined financial information in Annexures 1 and 2 in the form and context in which they are named and the inclusion in this document of the Independent Audit Report and Independent Review report in Annexures 1 and 2 in the form and context in which they are included. KPMG and KPMG Inc have authorised the contents of such reports for the purpose of PR 5.5.3R(2)(f) of the UKLA Prospectus Rules.
- Each of the Independent Competent Persons has given and has not withdrawn their written consent to the inclusion in this document of their report(s), set out in Annexure 6 (Independent Competent Persons' Reports) and to the references to their name included herein in the form and context in which it appears and has authorised the contents of those parts of this document, which comprise their report(s). Each of the Independent Competent Persons accepts responsibility for their report(s) as part of this document together with information in this document, which has been extracted directly from their report(s).
To the best of the knowledge of each of the Independent Competent Persons (each of whom has taken all reasonable care to ensure that such is the case), the information contained in their report(s) is in accordance with the facts and contains no omission likely to affect the import of such information.
- Greenwoods & Herbert Smith Freehills Pty Ltd has reviewed and agrees with and accepts responsibility for Section 13.2 relating to the description given of the tax implications of holding South32 Shares for South32 Shareholders who, among other things, are residents of Australia for Australian tax purposes. Greenwoods & Herbert Smith Freehills Pty Ltd has given, and has not withdrawn, its written consent to the inclusion in this document of Section 13.2 and to the references to its name included herein in the form and context in which it appears and has authorised the contents of Section 13.2. To the best of the knowledge of Greenwoods & Herbert Smith Freehills Pty Ltd (which has taken all reasonable care to ensure that such is the case), the information contained in Section 13.2 is in accordance with the facts and contains no omissions likely to affect the import of such information.

- Slaughter and May has reviewed and agrees with and accepts responsibility for Section 13.3 relating to the description given of the United Kingdom tax implications of holding South32 Shares for South32 Shareholders who, among other things, are residents of the United Kingdom for United Kingdom tax purposes. Slaughter and May has given, and has not withdrawn, its written consent to the inclusion in this document of Section 13.3 and to the references to its name included herein in the form and context in which it appears and has authorised the contents of Section 13.3. To the best of the knowledge of Slaughter and May (which has taken all reasonable care to ensure that such is the case), the information contained in Section 13.3 is in accordance with the facts and contains no omissions likely to affect the import of such information.
- Cleary Gottlieb Steen & Hamilton LLP has reviewed and agrees with and accepts responsibility for the description given of the United States federal income tax laws included in Section 13.4 (except for Section 13.4(b)(4)) of this document relating to the tax implications of holding South32 Shares for certain South32 Shareholders who, among other things, are subject to United States federal income tax on a net income basis with respect to income from the South32 Shares or ADSs. Cleary Gottlieb Steen & Hamilton LLP has given, and has not withdrawn, its written consent to the inclusion in this document of Section 13.4 (except for Section 13.4(b)(4)) and to the references to its name included herein in the form and context in which it appears and has authorised the contents of Section 13.4 (except for Section 13.4(b)(4)). To the best of the knowledge of Cleary Gottlieb Steen & Hamilton LLP (which has taken all reasonable care to ensure that such is the case), the information contained in Section 13.4 (except for Section 13.4(b)(4)) is in accordance with the facts and contains no omissions likely to affect the import of such information.
- Ernst & Young Advisory Services (Pty) Ltd has reviewed and agrees with and accepts responsibility for Section 13.5 relating to the description given of the South African taxation implications of holding South32 Shares for South32 Shareholders whose registered address on the South32 Share Register is in South Africa or who are otherwise deemed resident in South Africa for South African tax purposes. Ernst & Young Advisory Services (Pty) Ltd has given, and has not withdrawn, its written consent to the inclusion in this document of Section 13.5 and to the references to its name included herein in the form and context in which it appears and has authorised the contents of Section 13.5. To the best of the knowledge of Ernst & Young Advisory Services (Pty) Ltd (which has taken all reasonable care to ensure that such is the case), the information contained in Section 13.5 is in accordance with the facts and contains no omissions likely to affect the import of such information.
- Bell Gully has reviewed and agrees with and accepts responsibility for Section 13.6 relating to the description given of the New Zealand tax implications of holding South32 Shares for South32 Shareholders whose registered address on the BHP Billiton Limited Share Register is in New Zealand or who are otherwise deemed resident in New Zealand for New Zealand tax purposes. Bell Gully has given, and has not withdrawn, its written consent to the inclusion in this document of Section 13.6 and to the references to its name included herein in the form and context in which it appears and has authorised the contents of Section 13.6. To the best of the knowledge of Bell Gully (which has taken all reasonable care to ensure that such is the case), the information contained in Section 13.6 is in accordance with the facts and contains no omissions likely to affect the import of such information.

3.3 INVESTMENT DECISIONS

This document does not take into account the investment objectives, financial situation or particular needs of any BHP Billiton Shareholder, South32 Shareholder or any other person. This document should not be relied upon as the sole basis for any investment decision in relation to South32 Shares or any other securities, and you should consult your financial, legal, tax or other professional adviser before making any such investment decision.

3.4 FORWARD LOOKING STATEMENTS

Certain statements in this document relate to the future, including forward looking statements relating to South32's financial position and strategy. Forward looking statements can be identified by the use of terminology such as 'intend', 'aim', 'project', 'anticipate', 'estimate', 'plan', 'believe', 'expect', 'may', 'should', 'will', 'continue' or other similar words. These statements discuss future expectations concerning the results of operations or financial condition, or provide other forward looking statements.

These forward looking statements are not guarantees or predictions of future performance, and involve known and unknown risks, uncertainties and other factors, including the risk factors set out in Section 2, many of which are beyond BHP Billiton's or South32's control, and which may cause the actual results to differ materially from those expressed in the statements contained in this document. South32 Shareholders are cautioned not to put undue reliance on forward looking statements.

Other than as required by law, none of BHP Billiton, South32, their officers or their advisers or any other person gives any representation, assurance or guarantee that the occurrence of the events expressed or implied in any forward looking statements in this document will actually occur, in part or in whole.

Additionally, statements of the intentions of the South32 Board and/or Directors reflect the present intentions of the South32 Directors, respectively, as at the date of this document and may be subject to change as the composition of the South32 Board alters, or as circumstances require. Except as required by law, BHP Billiton and South32 disclaim any obligation or undertaking to update or revise any forward looking statement in this document.

The forward looking statements speak only as at the date of this document. To the extent required by applicable law or regulation (including as may be required by the Corporations Act, ASX Listing Rules, UKLA Prospectus Rules, UKLA Listing Rules, UKLA Disclosure and Transparency Rules, JSE Listings Requirements and Financial Markets Act), South32 will update or revise the information in this document. Otherwise, BHP Billiton and South32 expressly disclaim any obligation or undertaking to release publicly any updates or revisions to any forward looking statements contained in this document to reflect any change in expectations with regard thereto or any change in events, conditions or circumstances on which any such statement is based.

The statements above relating to forward looking statements are not intended to qualify the working capital statement set out in Section 15.20 of this document.

3.5 PRESENTATION OF FINANCIAL INFORMATION

This document includes both historical combined financial information and pro forma historical financial information for South32. The basis of preparation of the historical combined financial information is set out in Annexure 1 and the basis of preparation of the pro forma historical financial information is set out in Section 10.2.

The financial information contained in this document has been prepared and presented in accordance with the recognition and measurement requirements of:

- Australian Accounting Standards, being Australian equivalents to International Financial Reporting Standards and interpretations as issued by the Australian Accounting Standards Board;
- International Financial Reporting Standards and interpretations as adopted by the European Union;
- International Financial Reporting Standards and interpretations as issued by the International Accounting Standards Board.

The above accounting standards and interpretations are collectively referred to as **IFRS** in this document.

Information on departures from the disclosure requirements of IFRS is set out in the basis of preparation to the historical combined financial information set out in Annexure 1.

South32 uses the measures in Table 3.1 below which are included in the historical combined financial information in Annexures 1 and 2, in accordance with IFRS 8 'Operating Segments'.

South32 plans to use the measures of Underlying Earnings, Underlying EBIT and Underlying EBITDA to assess the performance of the South32 Group and the South32 Businesses. Underlying EBITDA and Underlying EBIT are calculated based on the accounting policy that South32 proposes to use when discussing its operating results in future periods. The accounting policy proposed by South32 for calculating these measures differs from that currently used by BHP Billiton, the key differences being that South32 will adjust for certain items each period, irrespective of materiality, and South32 management will retain the discretion to adjust for other significant non-recurring items that are not considered to reflect the underlying performance of the South32 Businesses. Refer to note 2 Segment reporting of Annexure 1 for further details of South32's policy for calculating Underlying Earnings, Underlying EBIT and Underlying EBITDA. South32 also uses a number of non-IFRS financial measures in addition to those reported in accordance with IFRS. The South32 Directors believe that these non-IFRS measures, listed below, are important when assessing the underlying financial and operating performance of South32 and the South32 Businesses.

Table 3.1: IFRS 8 measures

IFRS 8 measure	Definition
Underlying Earnings	Underlying Earnings is Profit after taxation and earnings adjustments. Earnings adjustments represent items that do not reflect the underlying operations of South32.
Underlying EBIT	Earnings before net finance costs, taxation and any earnings adjustments before net finance costs and income tax expense.
Underlying EBITDA	Underlying EBIT before depreciation and amortisation.

Non-IFRS measures used in this document are defined below:

Table 3.2: Non-IFRS measures

Non-IFRS measure	Definition
Adjusted effective tax rate	Comprises total taxation expense excluding the impact of exchange rate movements included in taxation expense, remeasurements of deferred tax assets associated with Minerals Resource Rent Tax (MRRT), non-recognition of tax benefits where the tax benefit resides with BHP Billiton and the tax impacts of amounts excluded from Underlying EBIT divided by Profit before taxation and amounts excluded from Underlying EBIT.
Underlying EBIT margin	Comprises Underlying EBIT excluding third party product profit from operations, divided by revenue excluding third party product revenue.

Non-IFRS measure	Definition
Underlying EBITDA margin	Comprises Underlying EBITDA excluding third party product EBITDA, divided by revenue excluding third party product revenue.
Margin on third party products	Comprises Underlying EBIT on third party products, divided by third party product revenue.
Net debt	Comprises interest bearing liabilities less cash and cash equivalents.
Net operating assets	Represents operating assets net of operating liabilities, including the carrying value of equity accounted investments and predominantly excludes cash balances, interest bearing liabilities and deferred tax balances.

3.6 INDEPENDENT COMPETENT PERSONS' REPORTS

The Independent Competent Persons' Reports, which are set out in Annexure 6, have been prepared by individuals who South32 believes to be sufficiently independent to provide those reports. As disclosed in the Independent Competent Persons' Reports, certain of those individuals have some small interests in BHP Billiton Shares. South32 does not consider those interests to be material so as to compromise the independence of the Independent Competent Persons' Reports.

The scope of work undertaken by each Independent Competent Person is set out in the relevant Independent Competent Person's Report.

In relation to each Independent Competent Persons Report, no material changes have occurred since the date of the Independent Competent Persons' Report the omission of which would make the Independent Competent Person's Report misleading.

3.7 CREDIT RATING

References to investment grade are made with reference to ratings criteria published by one or a combination of credit rating agencies which are registered under Regulation (EC) No. 1060/2009.

3.8 NOTICE TO BHP BILLITON SHAREHOLDERS OUTSIDE AUSTRALIA, THE UNITED KINGDOM AND SOUTH AFRICA

This document does not in any way constitute an offer of securities in any place in which, or to any person to whom, it would be unlawful to make such an offer.

The Demerger will not be registered with the United States' Securities and Exchange Commission under the United States' Securities Act of 1933, as amended. BHP Billiton expects South32 to qualify for the exemption from registration under Rule 12g3-2(b) of the Exchange Act, and accordingly the South32 Shares will not be registered under the Exchange Act and South32 will not be subject to the reporting requirements of the Exchange Act.

BHP Billiton Shareholders who are Ineligible Overseas Shareholders will not receive South32 Shares under the Demerger. South32 Shares that would otherwise be transferred to these shareholders under the Demerger will be transferred to the Sale Agent to be sold, with the net proceeds of such sale to be paid to Ineligible Overseas Shareholders. Refer to the Shareholder Circular for further information.

3.9 WHERE TO FIND HELP

If you have any additional questions in relation to this document, please call the Shareholder Information Line on:

BHP Billiton Limited Shareholders

- 1300 582 743 (within Australia) on weekdays between 8:30am and 7:30pm (AEST/ADST);
- +61 3 9415 4808 (international) on weekdays between 8:30am and 7:30pm (AEST/ADST).

BHP Billiton Plc Shareholders

UK register

- 0844 472 7001 (within the United Kingdom) on weekdays between 8:30am and 5:30pm (GMT/BST);
- +44 844 472 7001 (international) on weekdays between 8:30am and 5:30pm (GMT/BST).

South African register

- 086 1100 634 (within South Africa) on weekdays between 8:00am and 4:30pm (SAST);
- +27 11 870 8216 (international) on weekdays between 8:00am and 4:30pm (SAST).

BHP Billiton ADS Holders

- 877 248 4237 (within the United States) on weekdays between 8:30am and 6:00pm (EST/EDT);
- +1 781 575 4555 (international) on weekdays between 8:30am and 6:00pm (EST/EDT).

For legal reasons, the Shareholder Information Line will not provide advice on the merits of the Demerger or give any legal, financial or taxation advice, for which you are recommended to consult your own legal, financial or taxation adviser.

4 KEY TRADING DATES

The key dates relating to South32 securities trading on the ASX, JSE and LSE are set out below:

Table 4.1: Key trading dates

Event	Indicative date	ASX	JSE	LSE	Other
South32 Shares commence trading on the ASX on a deferred settlement basis	18 May 2015	12:00pm AEST			
South32 Shares commence trading on the JSE on a normal settlement basis	18 May 2015		9:00am SAST		
South32 Shares commence trading on the LSE on a when-issued basis	18 May 2015			8:00am BST	
South32 ADSs that will be distributed to BHP Billiton ADS Holders commence trading over-the-counter on a when-issued basis	18 May 2015				During the day EDT
Transfer of South32 Shares to Eligible BHP Billiton Limited Shareholders (BHP Billiton Limited Distribution Date)	24 May 2015	5:00pm AEST			
Transfer of South32 Shares to Eligible BHP Billiton Plc Shareholders (BHP Billiton Plc Distribution Date)	25 May 2015		Commencing 7:00am SAST ^(a)	8:30am BST	
Commencement of normal trading of South32 Shares on the LSE	26 May 2015			8:00am BST	
Distribution of South32 ADSs to BHP Billiton ADS Holders	29 May 2015				During the day EDT
South32 ADSs commence regular way trading in the over-the-counter market	1 June 2015				During the day EDT
Commencement of normal trading of South32 Shares on the ASX	2 June 2015	10:00am AEST			

(a) For the dematerialised holders this will be dependent on the Strate settlements process, commencing 7:00am SAST. Prior to start of trade on JSE (9:00am) for certificated holders.

All dates and times are indicative only and, among other things, are subject to change. Any changes to the timetable will be announced through the ASX, JSE and LSE and will be notified on BHP Billiton's website at www.bhpbilliton.com/demerger.

This page has been intentionally left blank.

5 SOUTH32 OVERVIEW

5.1 INTRODUCTION

On Demerger, South32 will be a globally diversified metals and mining company with a portfolio of high quality assets producing alumina, aluminium, coal, manganese, nickel, silver, lead and zinc.

South32 will comprise the following South32 Businesses, which are described in more detail in Section 7.1.

All financial information shown in Section 5 reflects historical combined financial information for South32 extracted from Annexures 1 and 2.

Diagram 5.1: South32's locations



Table 5.1: Worsley Alumina

Worsley Alumina (86 per cent interest) is an integrated bauxite mining and alumina refining operation located in Western Australia, Australia. Bauxite ore is mined near Boddington and conveyed to the Worsley Alumina refinery, located near Bunbury. Alumina is railed from Worsley Alumina to Bunbury for export to Worsley Alumina's export customers including South32's Hillside and Mozal Aluminium smelters in southern Africa. Worsley Alumina is one of the largest and lowest-cost alumina refineries in the world, being in the first cost quartile in its industry based on CY2013 production.¹ Worsley Alumina has a resource life of 63 years and a reserve life of 17 years.

South32's share of:	H1 FY2015	H1 FY2014	FY2014	FY2013	FY2012
Alumina production (kt)	1,953	1,970	3,916	3,675	2,917
Underlying EBITDA (US\$M)	143	108	162	60	(67)

¹ Source: C1 cash cost curve, Wood Mackenzie Alumina refinery costs league, 2014 Q4.

Table 5.2: South Africa Aluminium

South Africa Aluminium (100 per cent interest) comprises the Hillside smelter near Richards Bay, South Africa. The business previously included the Bayside smelter, which was closed in FY2014, and the Bayside casthouse. An agreement has been reached for the sale of the assets comprising the Bayside casthouse (the sale is subject to certain regulatory and other conditions, which are expected to be fulfilled during the first half of CY2015). Hillside is the largest aluminium smelter in the Southern Hemisphere and it imports alumina from the Worsley Alumina refinery. Historically, approximately 80 per cent of Hillside's aluminium production has been exported through Richards Bay Port with the balance of Hillside's aluminium production trucked to the Bayside casthouse or to domestic customers. The Hillside smelter extends across the first and second cost quartiles based on CY2013 production.²

South32's share of:	H1 FY2015	H1 FY2014	FY2014	FY2013	FY2012
Aluminium production (kt)	356	415	804	761	719
Underlying EBITDA (US\$M)	201	84	190	73	(10)

Table 5.3: Mozal Aluminium

Mozal Aluminium (47.1 per cent interest) is an aluminium smelter located near Maputo, Mozambique. Alumina is currently supplied to Mozal Aluminium from the Worsley Alumina refinery, which is majority owned by South32. Most of Mozal Aluminium's aluminium is currently exported to Europe through Matola, the port of Maputo. In CY2013, Mozal Aluminium had higher operating costs than the Hillside smelter (which extends across the first and second cost quartiles based on CY2013 production).³

South32's share of:	H1 FY2015	H1 FY2014	FY2014	FY2013	FY2012
Aluminium production (kt)	135	134	266	264	264
Underlying EBITDA (US\$M)	88	17	52	31	51

Table 5.4: Brazil Aluminium

Brazil Aluminium comprises South32's interests in the MRN Mine (14.8 per cent interest) as well as its interest in the Alumar alumina refinery (36 per cent interest) and Alumar aluminium smelter (40 per cent interest) (together with certain interests in ancillary facilities and lands). The MRN Mine is located in the Trombetas region in the state of Pará, Brazil and Alumar is located at São Luis in the state of Maranhão, Brazil. The majority of the bauxite produced from the MRN Mine is sold to its shareholders and related parties. South32's share of bauxite produced from the MRN Mine is supplied to the Alumar refinery and most of the alumina produced from the Alumar refinery is exported via the nearby São Marcos Bay facilities, with a small portion transferred to the Alumar smelter. All of Alumar's aluminium production is trucked to domestic customers. Brazil Aluminium's Alumar refinery is in the second cost quartile and the Alumar smelter is in the third cost quartile based on CY2013 production.⁴ MRN Mine has a resource life of 29 years and a reserve life of six years.

South32's share of:	H1 FY2015	H1 FY2014	FY2014	FY2013	FY2012
Alumina production (kt)	680	633	1,262	1,205	1,235
Aluminium production (kt)	26	63	104	154	170
Underlying EBITDA (US\$M)	140	35	127	44	3

2 Source: C1 cash cost curve, Wood Mackenzie Aluminium smelter costs league, 2014 Q4.

3 Based on the C1 cash cost curve, Wood Mackenzie Aluminium smelter costs league, 2014 Q4, Mozal Aluminium was in the first cost quartile based on CY2013 production. Refer to Section 7.1 for historical operating cost data for Mozal Aluminium and South Africa Aluminium.

4 Source: C1 cash cost curve, Wood Mackenzie Aluminium smelter costs league, 2014 Q4.

Table 5.5: South Africa Energy Coal

South Africa Energy Coal (90 per cent interest) operates four energy coal mines in the Witbank region in the Mpumalanga province of South Africa. Approximately 55 per cent of coal produced is sold domestically and the remainder is exported through the Richards Bay Coal Terminal (**RBCT**), in which South32 has a 21 per cent interest. South Africa Energy Coal is the third largest export energy coal producer in South Africa and fifth largest supplier of energy coal domestically. South Africa Energy Coal is in the second cost quartile based on CY2013 production.⁵ Khutala, Klipspruit, Wolvekrans and Middelburg mines have resource lives of 103 (inclusive of undeveloped domains), 12, 42 and 34 years and reserve lives of six, six, 21 and 23 years respectively.

100 per cent terms^(a):	H1 FY2015	H1 FY2014	FY2014	FY2013	FY2012
Energy coal production (kt)	16,525	14,973	30,384	31,627	33,279
Underlying EBITDA (US\$M)	83	54	197	115	416

(a) Production and earnings information for South Africa Energy Coal is shown on a 100 per cent basis. South32's ownership interest in South Africa Energy Coal is 90 per cent, with the remaining 10 per cent held by minority shareholders, the purchase of which was funded with vendor-financed loans (refer to Section 7.1(e)). However, from an accounting perspective, South32's interest in Underlying EBITDA will remain at 100 per cent until such loans are repaid to South32, following which South32's interest in Underlying EBITDA will be 90 per cent.

Table 5.6: Illawarra Metallurgical Coal

Illawarra Metallurgical Coal (100 per cent interest) operates three underground metallurgical coal mines near Wollongong in New South Wales, Australia. Metallurgical coal is trucked to Port Kembla or to BlueScope Steel Limited's (**BlueScope Steel**) Port Kembla steelworks. Illawarra Metallurgical Coal is in the second quartile of the industry margin curve based on CY2013 production⁶ and its mines have resource lives (inclusive of undeveloped domains) of 41, 15 and 43 years and reserve lives of 25, two and nine years for each of Appin, West Cliff and Dendrobium / Cordeaux respectively.

South32's share of:	H1 FY2015	H1 FY2014	FY2014	FY2013	FY2012
Metallurgical coal production (kt)	3,858	2,614	5,974	6,664	6,621
Energy coal production (kt)	880	741	1,539	1,278	1,305
Underlying EBITDA (US\$M)	120	70	135	302	818

Table 5.7: Australia Manganese

Australia Manganese (60 per cent interest) comprises the GEMCO open-cut manganese mine and the TEMCO manganese alloy plant. GEMCO, which is located in the Northern Territory, Australia, is one of the world's lowest-cost manganese ore producers. It exports to customers approximately 90 per cent of its ore product through port facilities at Milner Bay and the balance of the ore is shipped to the TEMCO manganese alloy plant in Bell Bay, Tasmania, Australia. The majority of TEMCO's alloy production is exported to customers in Asia and North America, with the balance of TEMCO's production being sold to steel customers in Australia and New Zealand. GEMCO is in the first cost quartile based on CY2013 production.⁷ GEMCO has a resource life of 15 years and a reserve life of 11 years.

100 per cent terms^(a):	H1 FY2015	H1 FY2014	FY2014	FY2013	FY2012
Manganese ore production (kt)	2,499	2,438	4,776	5,027	4,306
Manganese alloy production (kt)	139	123	269	234	198
Underlying EBITDA (US\$M)	215	252	505	499	335

(a) Production and earnings information for Australia Manganese is shown on a 100 per cent basis. South32's ownership interest in Australia Manganese is 60 per cent. South32's interest in Underlying EBITDA is 60 per cent.

⁵ Source: C1 cash cost curve, Wood Mackenzie Seaborne export thermal coal, energy adjusted, November 2014.

⁶ Source: Margin curve (to account for coal quality differentials), Wood Mackenzie Seaborne export metallurgical, November 2014.

⁷ Source: Site operating costs with value in use adjustment, CRU cost curve, August 2014.

Table 5.8: South Africa Manganese

South Africa Manganese comprises the Hotazel Mines, being the Mamatwan open-cut mine and the Wessels underground mine (44.4 per cent effective interest), and the Metalloys plant (60 per cent interest). The Hotazel Mines are located near the town of Kuruman, South Africa. Approximately 75 per cent of the ore processed at the mine results in export saleable product. The remainder of the ore is converted to alloy at the Metalloys plant, which is located near Johannesburg, South Africa. The Metalloys plant is one of the largest manganese alloy producers in the world and exports most of its product to customers in the United States, Europe and Asia. Hotazel Mines is in the third cost quartile based on CY2013 production.⁸ Hotazel Mines have resource lives of 24 and 92 years and reserve lives of 18 and 46 years for Mamatwan and Wessels respectively.

100 per cent terms^(a):	H1 FY2015	H1 FY2014	FY2014	FY2013	FY2012
Manganese ore production (kt)	2,056	1,808	3,526	3,490	3,625
Manganese alloy production (kt)	233	180	377	374	404
Underlying EBITDA (US\$M)	63	21	120	111	(18)

(a) Production and earnings information for South Africa Manganese is shown on a 100 per cent basis. South32's ownership interest in South Africa Manganese is 60 per cent, except Hotazel Mines which is 44.4 per cent. However, South32's interest in Underlying EBITDA is 60 per cent, except Hotazel Mines which is 54.6 per cent (please refer to Section 7.1(h)(2) for further details of the Broad-Based Black Economic Empowerment (**BBBEE**) arrangements).

Table 5.9: Cerro Matoso

Cerro Matoso (99.94 per cent interest) is an open-cut lateritic nickel mine and ferronickel smelter, located near Montelibano, in the Córdoba Department in northern Colombia, which produces high-purity, low-carbon ferronickel granules and is currently one of the largest nickel producers in the world. The product is transported approximately 260 km by road to Cartagena. Cerro Matoso is in the second cost quartile based on CY2013 production,⁹ and has a resource life of 37 years and a reserve life of 15 years.

South32's share of:	H1 FY2015	H1 FY2014	FY2014	FY2013	FY2012
Nickel production (kt)	21	24	44	51	49
Underlying EBITDA (US\$M)	113	43	87	234	417

Table 5.10: Cannington

Cannington (100 per cent interest) is a silver, lead and zinc underground mine and concentrator operation located in northwest Queensland, Australia, approximately 200 km southeast of Mount Isa, and is the world's largest silver producing mine. Concentrate produced at Cannington is trucked to the Yurbi rail loading facility and then railed approximately 800 km to the Port of Townsville for export to customers mainly located in northeast Asia, Europe and Canada. Cannington is in the first cost quartile of silver production based on CY2013 production on a co-product cost basis,¹⁰ and has a resource life of 22 years and a reserve life of nine years.

South32's share of:	H1 FY2015	H1 FY2014	FY2014	FY2013	FY2012
Silver production (koz)	12,235	12,667	25,161	31,062	34,208
Lead production (kt)	99	94	187	213	239
Zinc production (kt)	37	32	58	56	55
Underlying EBITDA (US\$M)	183	272	460	651	893

Details regarding resource and reserve life calculations

Resource and reserve life information in Section 5 is based on the information in Section 7.2. Resource life is estimated from the FY2014 Classified Mineral or Coal Resources (as applicable), and as provided in the ASX release titled, 2014 BHP Billiton Annual Report – 25 September 2014 available on the BHP Billiton website at www.bhpbilliton.com or the ASX website at www.asx.com.au, converted to a run-of-mine basis using historical Mineral or Coal Resources (as applicable) to Ore Reserves conversion factors, divided by the FY2014 run-of-mine production rate on a 100 per cent basis. Weighted average individual mines Mineral or Coal Resources (as applicable) to Ore Reserves conversion factors and run-of-mine tonnages comprise:

- Worsley Alumina: 0.96, 17.4 Mt;
- Brazil Aluminium: 0.99, 17.75 Mt;
- South Africa Energy Coal – all resources: 0.83, 38.05 Mt;

⁸ Source: Site operating costs with value in use adjustment, CRU cost curve, August 2014.

⁹ Source: C1 cash cost curve, Wood Mackenzie Nickel industry costs league, 2014 Q4.

¹⁰ Source: Estimated 2013 silver cost information, AME Group.

- Illawarra Metallurgical Coal: Appin 0.38, 6.56 Mt, West Cliff 0.38, 2.81 Mt, Dendrobium/Cordeaux 0.34, 3.85 Mt;
- Australia Manganese: 0.69, 8.8 Mt;
- South Africa Manganese: Mamatwan 0.72, 3.2 Mt, Wessels 0.60, 0.9 Mt;
- Cerro Matoso: 0.33, 3.2 Mt;
- Cannington: 1.00, 3.4 Mt.

Resource life calculations are indicative only and do not necessarily reflect future uncertainties such as economic conditions, technical or permitting issues.

Reserve life is calculated based on the current stated Ore Reserves divided by the current approved nominated production rate as at the end of FY2014. For Cannington, estimated Ore Reserves are divided by a declining production rate.

Historical Mineral or Coal Resources to Ore Reserves conversion factors may not be indicative of future conversion factors.

5.2 SOUTH32 ORGANISATIONAL STRUCTURE

Following the Demerger, South32 intends to adopt a regional organisational structure, as shown in Diagram 5.2. The key aspects of this organisational structure are as follows:

- South32's head office will be in Perth, Australia;
- South32 will operate two regional business hubs for its operations, one in Perth, Australia, which will be co-located with South32's head office, and one in Johannesburg, South Africa;
- South32's centralised marketing function will be based in Singapore;
- South32 intends to have a global shared services centre in Johannesburg, South Africa.

Diagram 5.2: Organisational structure

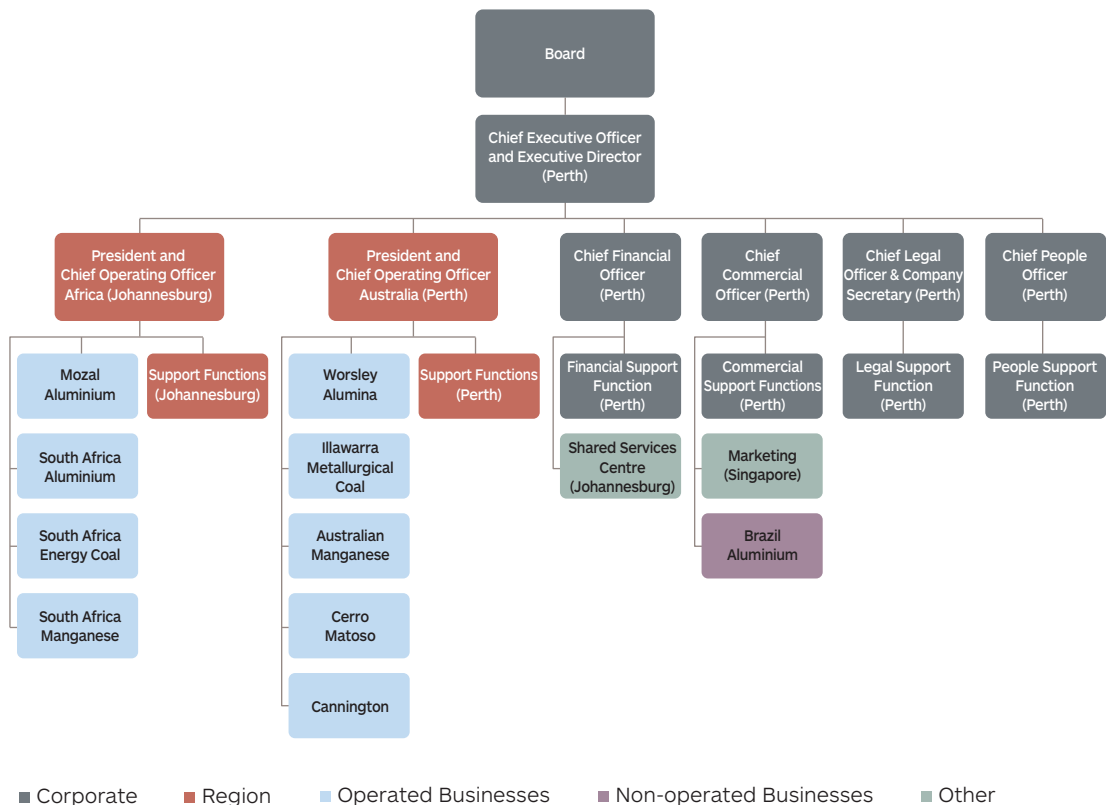

South32 Businesses are generally located in Australia and Africa, which facilitates South32's implementation of a regional organisational model. The regional organisational model involves combining the business units and assets into regional business units, which will reduce a layer of management. More authority will be devolved to regional business units, reducing the size of South32's corporate centre and facilitating greater alignment with regional stakeholders.

A regional organisational structure is considered appropriate for South32 because the majority of its assets are geographically concentrated and because of the generally smaller scale of its operations compared to that of BHP Billiton, which allows for increased support at the regional organisational level, as opposed to the asset organisational level.

This model will involve aggregating functional support, such as finance, supply planning and human resources support, at the regional organisational level. This differs from the operating model employed under BHP Billiton's ownership, where such functional support has been provided at the asset organisational level.

5.3 STRATEGY

South32 intends to maximise value for shareholders by being a safe, lean, responsible and predictable operator of its portfolio of high quality diversified metals and mining assets, and by managing its capital in a disciplined way.

South32 intends to meet these objectives by pursuing the following strategic priorities:

- **Establish a distinctive, powerful culture and identity.** South32 is proud of its BHP Billiton heritage but will create a new and independent culture and identity suited to its scale and requirements. South32 intends to adopt a flexible, agile and entrepreneurial approach designed to maximise the value of its assets. This approach will seek to foster a culture of innovation and continuous improvement.
- **Enhance environmental, health, safety and social programs.** South32 recognises that all stakeholders benefit from a sustainable business and considers it a strategic priority to enhance its environmental, health, safety and social programs for the benefit of employees, host communities and governments.
- **Embed an efficient operating model that is aggregated at the regional level.** South32's operating model will be designed to ensure that each asset is operated in the most efficient manner. An important aspect of the South32 operating model is the regional organisational structure, which is described in Section 5.2 and is expected to help drive more efficient and productive operations.
- **Reduce costs and improve productivity.** South32's assets have benefited from the structured and focused approach to productivity pursued by BHP Billiton. South32's lean operating model and performance-oriented culture offer the potential for additional gains, which may further enhance the already competitive position of South32's assets.
- **Create strong alignment with investors.** South32 will adopt a simple approach to manage its capital, with a view to generating strong cash returns. South32 will, in a manner consistent with its dividend policy described in Section 5.5, seek to return a proportion of Underlying Earnings as dividends. Other alternatives including special dividends, share buy-backs and high return investment opportunities will compete for excess capital.
- **Develop and pursue investment opportunities.** South32 will rigorously evaluate and only pursue high quality investment options that meet strict financial criteria, including the low-cost, value accretive brownfield investment options that are embedded in its existing assets.
- **Continually seek to optimise the portfolio.** South32 intends to continuously assess the make-up of its diverse portfolio of assets to ensure its capital is being deployed in the most efficient manner.

5.4 KEY STRENGTHS

(a) A significant diversified metals and mining company

The South32 Businesses have a significant presence in each of its major commodities. This includes being the world's largest producer of manganese ore, a top producer of silver and manganese alloy, and one of the world's largest ferronickel producers.

With operations spread across five countries and producing 10 commodities, South32's diversification reduces its sensitivity to the price volatility of individual commodities and its reliance on individual operations, customers and regions.

Chart 5.1: Diversification of South32 revenue and Underlying EBITDA^(a)

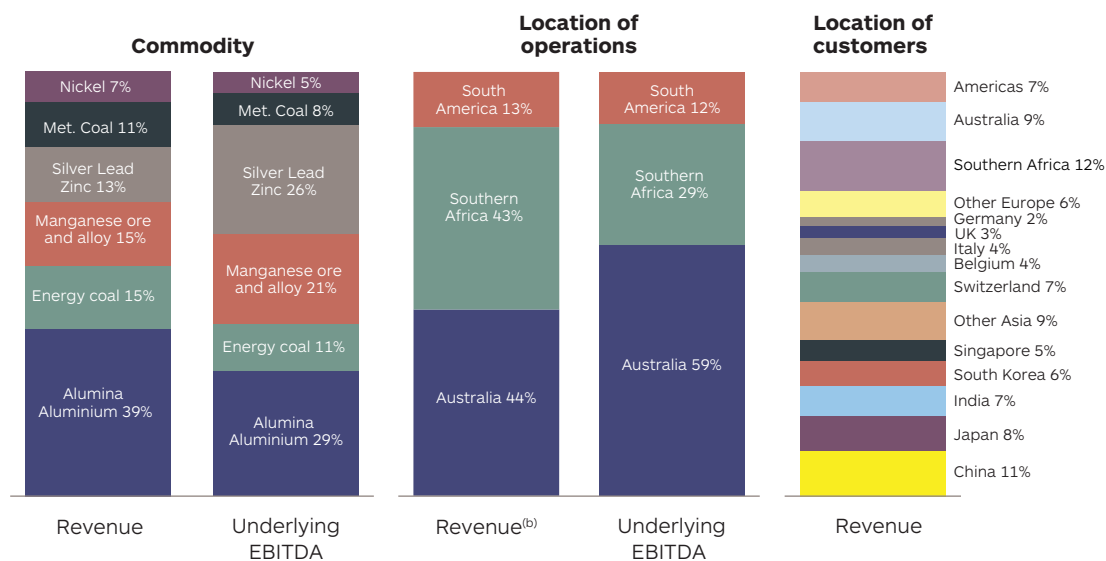

(a) Based on FY2014. Underlying EBITDA represents South32's accounting policy. Manganese revenue and Underlying EBITDA presented on a proportional consolidation (60 per cent) basis.

(b) Includes inter-segment revenue.

(b) A high quality, well-managed portfolio with competitively positioned assets

South32 will have a number of large assets, the majority of which are competitively positioned in the first or second quartile of their respective industry cost curves. For example, Worsley Alumina is one of the largest and lowest-cost global alumina refineries.

South32's operated assets benefit from having historically been managed and maintained in accordance with BHP Billiton's standards and practices.

Recently completed projects include investments in Australia Manganese, completed in 2013, Worsley Alumina, completed in 2013, and South Africa Energy Coal, completed in 2010.

Chart 5.2: South32 total capital expenditure^(a) over past 10 years

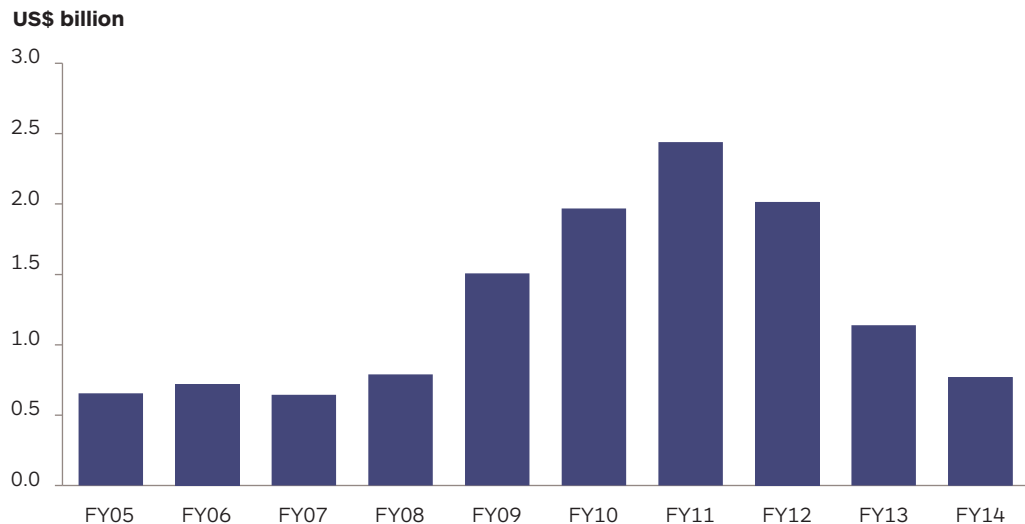

(a) The capital expenditure for FY2012 to FY2014 is based on historical combined financial information for South32 included in Annexure 1. For the period FY2005 to FY2011 the capital expenditure is based on information previously published by BHP Billiton as unaudited supplementary financial information released as part of BHP Billiton's results announcements.

(c) Meaningful reserve and resource lives

Many of South32's assets have significant reserve lives, which positions South32 to sustain production from existing assets without the immediate need for material incremental capital expenditure to extend mine lives. These reserve lives are complemented by material incremental resources with the potential to further extend mine lives.

Table 5.11: South32 reserve lives and resource lives

	Reserve life (years)^(a)	Resource life (years)^(b)
Worsley Alumina	17	63
Brazil Aluminium	6	29
South Africa Energy Coal ^(c)	6, 6, 21, 23	103, 12, 42, 34
Illawarra Metallurgical Coal ^(d)	25, 2, 9	41, 15, 43
Australia Manganese	11	15
South Africa Manganese ^(e)	18, 46	24, 92
Cerro Matoso	15	37
Cannington	9	22

(a) Estimated Ore Reserves (as set out in Section 7.2) divided by the current approved nominated production rate as at the end of FY2014. For Cannington, estimated Ore Reserves are divided by a declining production rate.

(b) Resource life is estimated from the FY2014 Classified Mineral or Coal Resources (as applicable), and provided in the ASX release titled, 2014 BHP Billiton Annual Report – 25 September 2014 available on the BHP Billiton website at www.bhpbilliton.com or the ASX website at www.asx.com.au, converted to a run-of-mine basis using historical Mineral or Coal Resources (as applicable) to Ore Reserves conversion factors, divided by the FY2014 run-of-mine production rate on a 100 per cent basis. Details regarding resource and reserve life calculation are set out in Section 5.1.

(c) Lives shown for four mines: Khutala, Klipspruit, Wolvekrans and Middelburg respectively. Khutala Coal Resource life is inclusive of undeveloped domains.

(d) Lives shown for three mines: Appin, West Cliff and Dendrobium respectively. Dendrobium Coal Resource life is inclusive of Cordeaux resources. All resource lives are inclusive of undeveloped domains.

(e) Lives shown for two mines: Mamatwan and Wessels respectively.

(d) Cash generative business

Over the last three years, the South32 Group has generated cash flow in excess of both investment and sustaining capital expenditure, despite falling commodity prices.

Chart 5.3: South32 historical combined cash generation and capital expenditure

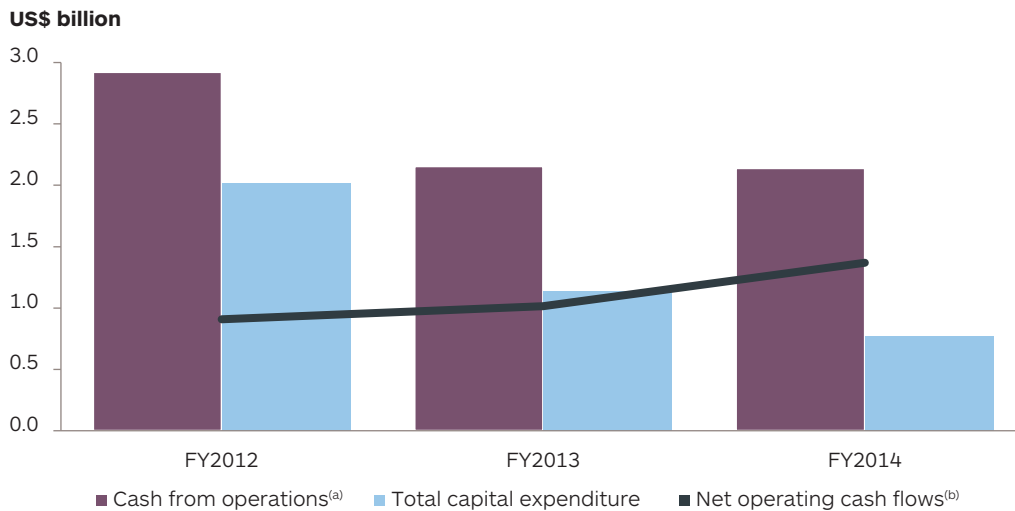

(a) Cash generated from operations including dividends received (including from equity accounted investments).

(b) Net operating cash flows before financing activities and tax and after capital expenditure. On a pro forma basis, net operating cash flows before financing activities and tax and after capital expenditure would be US\$1,035 million in FY2014 (as extracted from Section 10.4 Table 10.2).

(e) A financial position that provides strength and flexibility

South32 expects to have the financial strength and flexibility to implement its strategic objectives of returning cash to shareholders and investing in value accretive opportunities.

On implementation of the Demerger, South32 is expected to have net debt of US\$674 million, including finance leases (based on pro forma net debt as at 31 December 2014). South32 will have a committed US\$1.5 billion credit facility from a syndicate of international banks. Refer to Section 10.7 for further details.

South32 will target an investment grade credit rating throughout the cycle, with financial policies in place to safeguard its balance sheet strength and flexibility.

A range of potential projects are available to South32, with selected identified opportunities described in Section 7.1. Subject to further studies and pending South32 Board and management approvals, potential projects include:

- **Klipspruit Extension (South Africa Energy Coal):** A life extension project for the Klipspruit opencast, export-oriented mine.
- **Khutala Life Extension (South Africa Energy Coal):** A proposed life extension project for the existing Khutala Colliery, including the replacement of underground volumes with production from one or more surface mines.
- **Cannington mine life extension (Cannington):** In the past, a number of studies have been undertaken into a possible open-cut development at Cannington. South32 management will carefully assess alternatives for effectively exploiting this significant resource.

(f) An experienced and capable South32 Board and management team with a clear strategy to drive operational performance

South32 will benefit from a dedicated board and management team leading the execution and implementation of a tailored operating strategy.

South32's management has a broad range of mining, commercial, exploration and financial experience.

The South32 senior management team set out in Section 8.2 has an average of 18 years of metals and mining experience, with members of the team having a track record of generating earnings improvements through cost management, productivity improvements and value accretive investments, both in roles with BHP Billiton and with other organisations. The team will have a near-term focus on cash flow and will seek to increase shareholder value by enhancing efficiency, with a drive towards lean operating and project development outcomes and by remaining financially disciplined.

Although operating independently after implementation of the Demerger (subject to limited transitional arrangements), South32 intends to maintain the same commitment to safe, reliable and sustainable operations as that of BHP Billiton.

(g) A tailored operating model that allows targeted asset management

The regional organisational model involves combining the business units and assets into regional business units, which will reduce a layer of management. This will allow focused decision-making that is responsive to, and tailored for, regional needs. Further, operating with more authority devolved to regional business units will allow South32 to reduce the size of its corporate centre and facilitate greater alignment with its regional stakeholders. This will allow South32 to work towards better decision-making and is expected to facilitate cost reduction over the coming years.

5.5 DIVIDEND POLICY

The South32 dividend policy will be determined by the South32 Board at its discretion, having regard to South32's first two priorities for cash flow, being a commitment to maintain safe and reliable operations and an intention to maintain an investment grade credit rating through the cycle.

South32 intends to distribute a minimum of 40 per cent of Underlying Earnings as dividends to its shareholders following each six month reporting period. Consistent with South32's priorities for cash flow and commitment to maximise total shareholder returns, other alternatives including special dividends, share buy-backs and high return investment opportunities will compete for excess capital.

South32 will distribute dividends with the maximum practicable franking credits for the purposes of the Australian dividend imputation system. The extent to which a dividend can be franked will depend on South32's franking account balance (which immediately following the Demerger will be nil) and its level of distributable profits. South32's franking account balance will depend on the amount of Australian income tax paid by South32 following the Demerger. The timing of South32's Australian income tax payments may also impact its capacity to frank any dividend declared for the half year ending 31 December 2015.

No assurance can be given in relation to the level of future dividends or the franking of such dividends (if any), as these will depend on future events and circumstances.

South32 does not intend to pay a dividend for the period ending 30 June 2015, which will conclude only one month after the implementation of the Demerger.

Additional detail on the payment of dividends under South32's Constitution can be found in Section 15.4(h).

This page has been intentionally left blank.

6 MARKET OVERVIEW

Set out below is a summary of aspects of the industries in which South32 operates. Refer to Section 11.2 for a discussion of recent trends in these markets and the impact of these trends on South32's financial results.

6.1 BAUXITE, ALUMINA AND ALUMINIUM INDUSTRY

(a) Background

Overview

Aluminium is produced from bauxite via a two-step process:

- First, bauxite is refined to alumina, the typical standard of which is in excess of 98.5 per cent pure aluminium oxide. A small portion (less than 10 per cent) of alumina produced is not processed into aluminium, but used in other applications.
- Secondly, to process alumina to aluminium, the alumina produced undergoes electrolytic smelting to form aluminium.

Typically, two to three units of bauxite are required to produce one unit of alumina (actual ratios depend upon the bauxite grade), while approximately two units of alumina are required to produce one unit of aluminium. Bauxite is one of the most abundant metal ores in the Earth's crust.

End uses

Aluminium has a wide range of end-use demand segments, which include transportation, construction, packaging, power applications, machinery, equipment and consumer durables. The diverse nature of end uses for aluminium provides multiple sources for potential ongoing demand growth.

A small portion (less than 10 per cent) of alumina produced is used in applications such as ceramics, abrasives, flame retardants and industrial processing.

Trading and pricing

Traditionally, the third party bauxite segment has been limited, with most bauxite mines vertically integrated with a neighbouring alumina refinery. With the recent growth in the third party bauxite segment, largely supplying China, the segment is increasingly trading on supply and demand fundamentals and attempts are being made by a number of publications to establish a bauxite pricing index.

Alumina is not exchange traded; rather, it is sold directly to end-users and traders, with no ability to deliver to a terminal exchange warehouse (for example the LME). Historically, alumina was sold on a percentage of aluminium price basis, but in recent years the industry has transitioned to more material being sold either on a spot pricing basis, or contracts linked to an alumina-specific index.

The recognised reference price for aluminium is the LME daily cash settlements for deliverable metal of a minimum purity and particular chemistry. Physical aluminium has in recent years been sold at a premium to LME prices. Aluminium premiums are driven by the broad supply and demand balance in the market and vary according to the delivery location.

Historical Platts alumina pricing and LME aluminium pricing is provided in Annexure 5. Historical average prices realised by South32's alumina and aluminium operations are provided in Section 7.1.

(b) Supply and demand

Total world production of alumina reached 107 Mt in 2013, with China, Australia and Brazil being the largest producers. China relies heavily on imported bauxite ore to meet its supply requirements.

Global primary aluminium production totalled 51 Mt in 2013,¹ with China being the major producing region. China has expanded smelting capacity in recent years to keep up with domestic demand growth and is currently substantially self-sufficient in aluminium. China's primary aluminium is 74 per cent of the country's consumption, with the balance supplied from scrap.

China accounted for almost half of global demand in 2013, with its recent growth in demand driven by increasing penetration of aluminium in end-use sectors such as automotive, transportation and power.

¹ Source: Wood Mackenzie.

Primary aluminium supply and demand

Chart 6.1: Production (Mt)

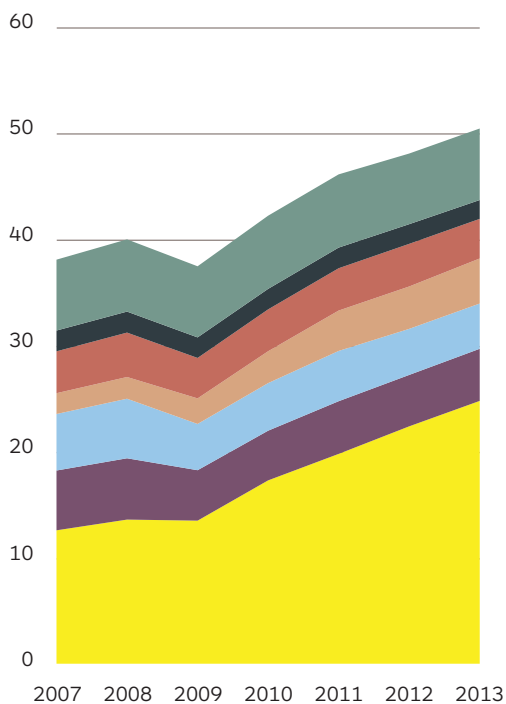
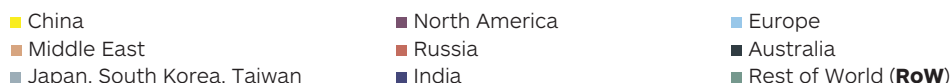
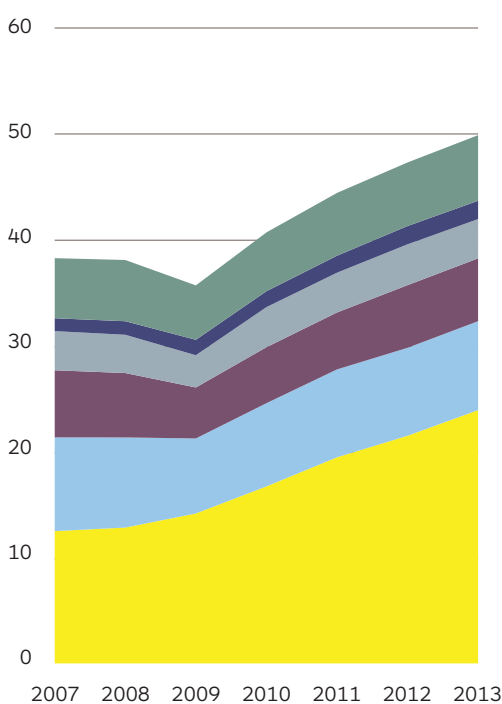

Chart 6.2: Demand (Mt)



Source: Wood Mackenzie

6.2 ENERGY COAL INDUSTRY

(a) Background

Overview

Coal is a fossil fuel, comprising mainly of carbon, hydrogen and oxygen. The types of coal in order of coalification are peat (lowest rank), lignite, sub-bituminous coal, bituminous coal and anthracite (highest rank). Energy coal comprises both sub-bituminous and bituminous (steam) coal. It is extracted through surface and underground mining.

End uses

The major applications for energy coal are power generation, cement manufacture and industrial use. Currently, coal accounts for around 40 per cent of global electricity production. It is the world's second largest source of primary energy largely due to the fact it is abundant, widely distributed across the globe and affordable.

Trading and pricing

The energy coal segment is split into paper and physical trading. The former is typically financially settled and the latter is typically bilaterally traded. In the physical segment, the product is sold directly to end-users and traders.

The international energy coal market is priced in US dollars per metric tonne and there is a wide range of coal with different calorific values in the market. In general, energy coals with higher calorific values have a higher price.

Index providers for energy coal include Argus, IHS McCloskey and GlobalCOAL. The main benchmark price references for export coal are FOB Newcastle (gcNewc) for the Pacific and FOB Richards Bay (API 4) and CIF Northwest Europe (API 2) for the Atlantic.

Historical FOB Richards Bay (API 4) energy coal pricing is provided in Annexure 5. Historical average prices realised by South32's energy coal operations are provided in Section 7.1.

(b) Supply and demand

Global energy coal production was 7.2 Bt in 2013,² with total seaborne exports at 949 Mt. The largest exporters of energy coal are Indonesia and Australia. During the period of 2007 to 2013, Indonesia and Australia recorded compound annual production growth rates of 14 per cent and nine per cent respectively.

Demand from Asia-Pacific continues to be the key driver of global seaborne energy coal demand, primarily due to electrification and industrial expansion in Asia.

Chart 6.3: Seaborne exports (Mt)

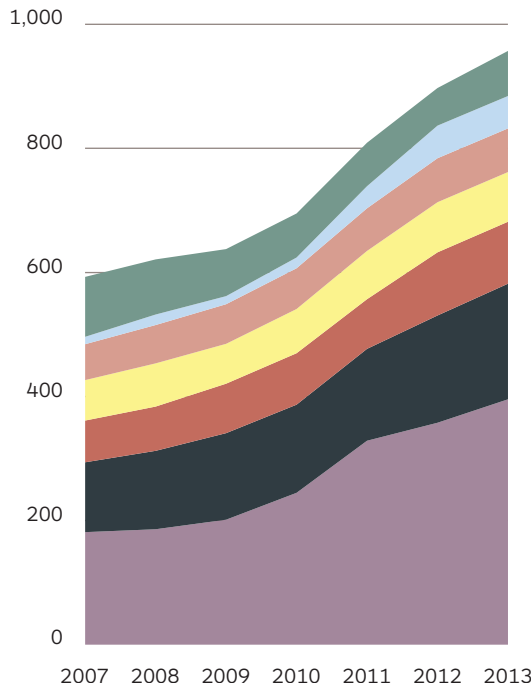
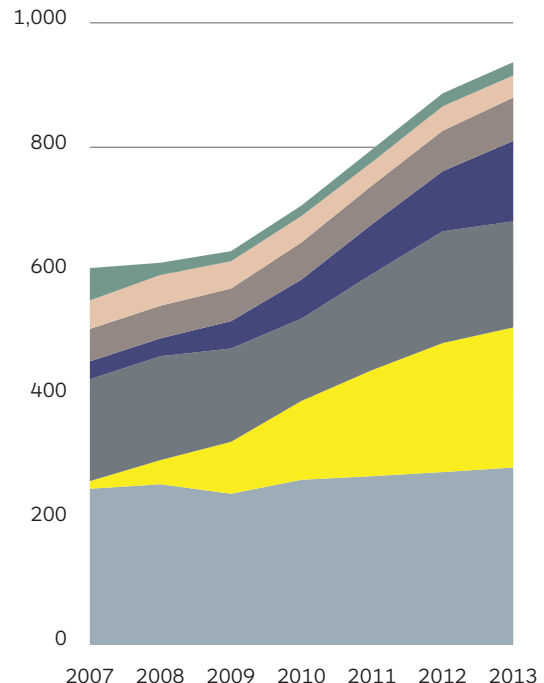

Chart 6.4: Import demand (Mt)



- Indonesia
- Australia
- Russia
- Colombia
- South Africa
- United States
- Japan, South Korea, Taiwan
- China
- Europe
- India
- Southeast Asia & Hong Kong
- Americas
- RoW

Source: Wood Mackenzie

6.3 METALLURGICAL COAL INDUSTRY

(a) Background

Overview

Metallurgical coal is a fossil fuel, comprising mainly of carbon, hydrogen and oxygen. Metallurgical coal is defined in three broad categories: hard coking coals, weak coking coals and PCI (pulverised coal injection). Hard coking coal produces high strength coke, while semi-soft or weak coking coal produces a lower strength coke. The utility of high-strength coke is greater in large, efficient blast furnaces and when high productivity is required.

End uses

Metallurgical coal is primarily used in the steel production process, which involves a variety of metallurgical coals being blended and converted into coke in an oven, which is typically located on site at steel mills. The coke is then charged in alternating layers with iron ore into the blast furnace where pig iron is created.

² Source: Wood Mackenzie.

Trading and pricing

Marketing of metallurgical coal is based on the three different types, each of which has a range of blends that offer different chemical properties. Sales are made to end-user steel mills, merchant cokeries and increasingly to traders as the market becomes more commoditised. Contracts are priced in US dollars per metric tonne.

Metallurgical coal has traditionally been sold through an annual benchmark pricing system, but the market has more recently evolved to index-based contracts.

Price reporting agencies for metallurgical coal include Platts, Argus, The Steel Index, Steel First and IHS McCloskey.

Historical metallurgical coal pricing (2011 onwards Platts Low-Vol Hard Coking Coal Index and pre-2011 Tex Reports hard coking coal) is provided in Annexure 5. Historical average prices realised by South32's metallurgical coal operations are provided in Section 7.1.

(b) Supply and demand

Global metallurgical coal production was 1.1 Bt in 2013, with total seaborne exports at 303 Mt. Metallurgical coal resources are geographically concentrated, with the top five producing countries accounting for more than 90 per cent of the total seaborne supply. China is the largest producer, but relies on imports to meet demand growth. Export supply growth has principally been driven by Australia, where a number of new projects have recently been delivered.

Global demand growth continues to be driven by Chinese consumption and Indian urbanisation. China overtook Japan to become the largest importer of seaborne metallurgical coal in 2013.³ India's demand is expected to grow as urbanisation and industrialisation gathers pace.

Chart 6.5: Seaborne exports (Mt)

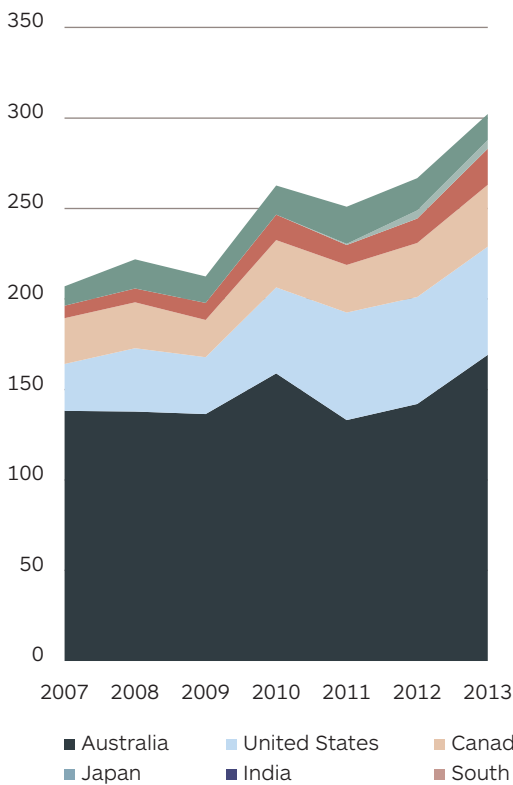
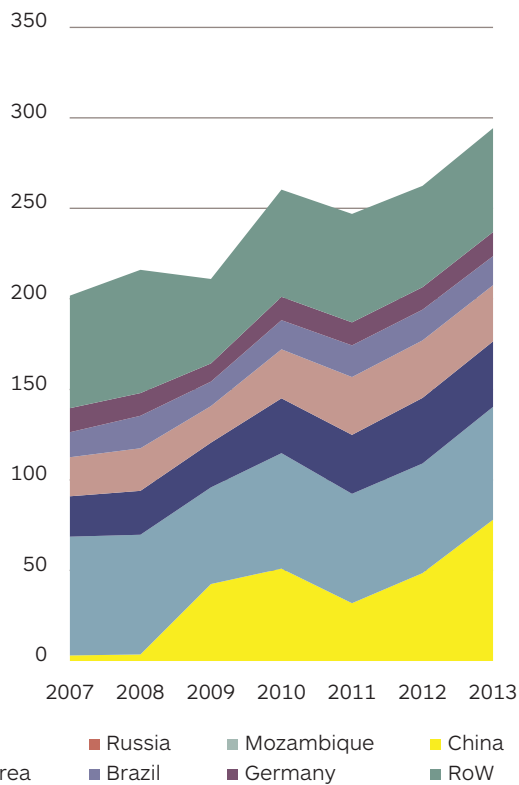

Chart 6.6: Import demand (Mt)



Source: Wood Mackenzie

³ Source: Wood Mackenzie.

6.4 MANGANESE INDUSTRY

(a) Background

Overview

Metallurgical grade manganese ore is extracted through open-cut and underground mining. Manganese ferroalloys are commercially produced by carbothermic reduction of ores, either through a blast furnace or electrical smelting process.

End uses

Manganese is currently the fourth largest metal in terms of global consumption, behind iron, aluminium and copper. The major application for manganese is in steel production. Minor applications for manganese include use in batteries, aluminium/copper alloys, chemicals (potassium permanganate) and fungicides.

Manganese ore smelting and refining are intermediate businesses involving the conversion of ore to alloys in a form suitable for addition to steel. There are various manganese alloys and grades, such as silicomanganese (**SiMn**), high-carbon ferromanganese (**HCFeMn**) and refined alloys such as medium-carbon ferromanganese (**MCFeMn**). SiMn is commonly used in the production of long steel products, which are critical components in the construction industry, while HCFeMn and MCFeMn are generally used in the production of flat steel products.

Trading and pricing

Manganese is sold directly to end-users and traders, and there is no ability to deliver either ore or alloy to a terminal exchange warehouse. Since 2009, quotational periods for manganese ore have changed from quarterly to monthly and weekly, and the industry is in further transition to spot pricing and index-based contracts.

Ore is priced in US dollars per dry metric tonne unit and there is a wide range of ore grades in the market, with high-grade ores generally achieving higher prices. Alloy products are more standardised (as they are an intermediate product) although price differences can exist between regions due to localised supply and demand balances, different lead-times to supply and differences in logistics options.

Index publications for manganese ore and alloys include CRU, Ryan's Notes, Metal Bulletin and Platts. There is not sufficient liquidity and scale for the development of a transparent forward market.

Historical manganese ore pricing and historical manganese alloy pricing (CRU Bulk FerroAlloy HCFeMn Western Europe) is provided in Annexure 5. Historical average prices realised by South32's manganese operations are provided in Section 7.1.

(b) Supply and demand

Global production of manganese ore reached 50 Mt in 2013,⁴ with China, South Africa and Australia being the largest producers. China's supply is typically lower grade and is insufficient to meet growing domestic demand. Major exporters of manganese ore are South Africa, Australia and Gabon. Global manganese alloy production in 2013 totalled 18.1 Mt, with SiMn being the main alloy produced.⁵ More than two thirds of manganese alloy production is in China and India, which is consumed domestically in these countries.

Chinese and Indian demand continues to be the key driver of manganese consumption, primarily due to steel production for continued urbanisation and infrastructure development. China accounted for half of global ore consumption in 2013,⁶ and relies increasingly on imports to meet demand growth. China accounted for approximately 64 per cent of global ore imports in 2013.

⁴ Source: CRU.

⁵ Source: CRU.

⁶ Source: CRU.

Chart 6.7: Ore production
(Mt, manganese content unadjusted)

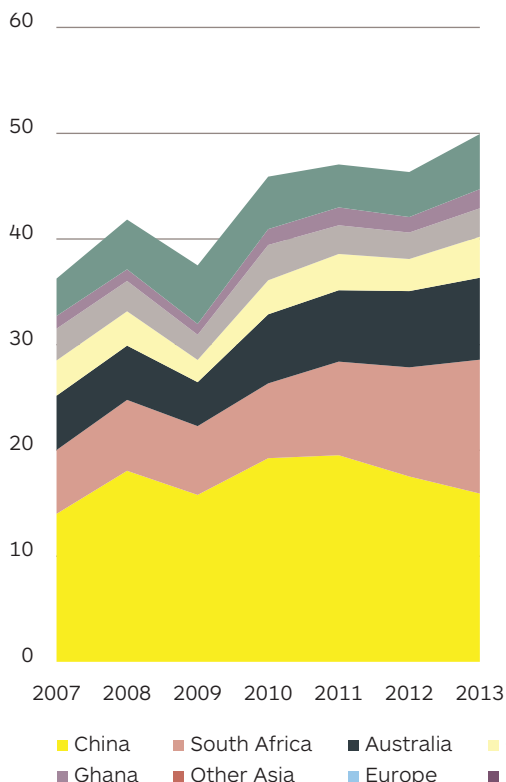
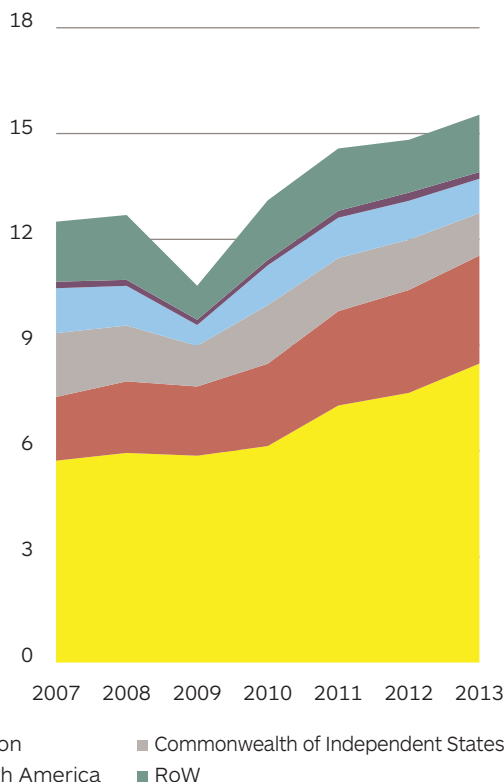

Chart 6.8: Ore demand in alloys
(Mt, contained manganese basis)



Source: CRU

6.5 NICKEL INDUSTRY

(a) Background

Overview

Nickel occurs as a mineral ore usually in oxide (laterite) or sulphide form. Nickel ores are mined by either open-cut or underground methods, and then processed into higher purity nickel forms such as ferronickel, nickel metal or nickel oxides. There are various processing methods, including concentrating then smelting and refining operations, direct smelting and leaching operations.

Historically, the majority of primary supply of nickel came from sulphide ores, which commonly provide significant co-product credits. The remaining economic resource base is now mostly lower grade laterite, which is less expensive to mine but more expensive to process.

End uses

Nickel is rarely used in its pure form; rather it is combined with other metals to form a range of alloys with properties that cannot be achieved by pure metals alone. Nickel's main use is in the manufacture of stainless steel alloys, which accounts for about two thirds of total primary nickel usage, while the balance is used in the production of non-stainless steel materials such as batteries and super-alloys.

Trading and pricing

The reference price is the LME cash settlement price for deliverable nickel with a minimum purity of 99.80 per cent.

Non-LME deliverable material, or products with qualities exceeding the LME specification, are sold at discounts or premiums to the LME benchmark.

Historical nickel pricing is provided in Annexure 5. Historical average prices realised by South32's nickel operations are provided in Section 7.1.

(b) Supply and demand

Global production of mined nickel ore reached 2.3 Mt (on a contained nickel basis) in 2013,⁷ with Indonesia being the largest mined ore production region. However, in January 2014 the Indonesian Government banned ore exports, resulting in volatile prices in the subsequent months.

Nickel is a late economic development cycle commodity. Chinese demand has increased rapidly in the last decade, and now accounts for approximately half of global demand. Indian demand for nickel has begun to grow rapidly, albeit from a low base.

The rapid rise in demand within China has been met with a supply response through the emergence of Chinese nickel pig iron (NPI) production, whereby imported nickel bearing laterite ore (mostly from Indonesia and the Philippines) was smelted domestically in China to produce a crude nickel pig iron alloy which was then used in the production of stainless steel. The majority of the incremental demand growth since 2009 has therefore been met by NPI production from ore imports, rather than through increased imports of nickel metal.

The recycling of nickel-bearing materials forms an important part of the supply and demand balance. Scrap usage varies by region, but at a global level approximately 40 per cent of nickel units come from scrap.

Primary nickel

Chart 6.9: Ore production (Mt, contained Nickel basis)

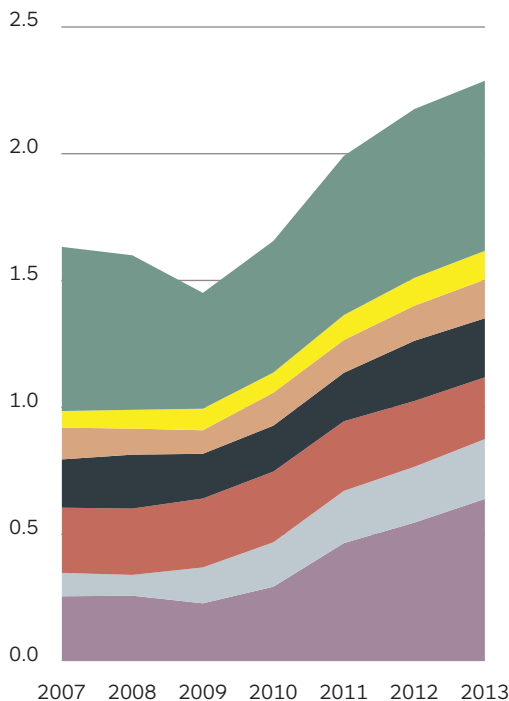
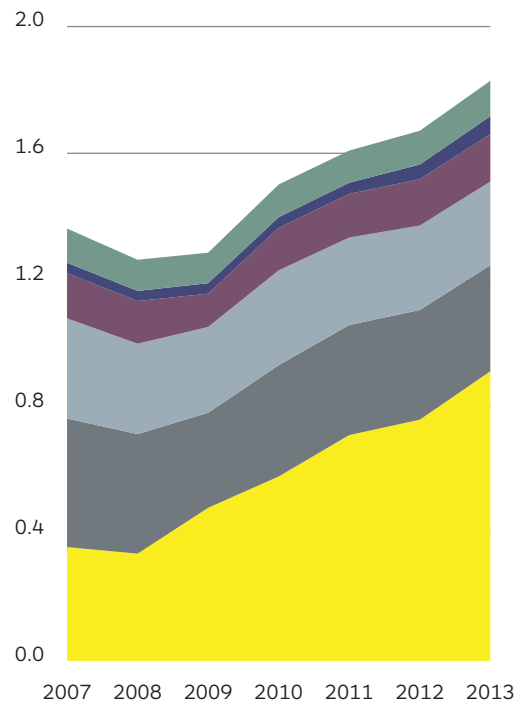

Chart 6.10: Demand in alloys (Mt, contained Nickel basis)



- Indonesia
- Australia
- Europe
- India
- Philippines
- New Caledonia
- Japan, South Korea, Taiwan
- RoW
- Russia
- China
- North America

Source: Wood Mackenzie

⁷ Source: Wood Mackenzie.

6.6 SILVER, LEAD AND ZINC INDUSTRY

(a) Background

Overview

Silver, lead and zinc are commonly found together, with silver being associated with the lead minerals. Processing of the ore yields two separate concentrates: lead (containing silver) and zinc. The lead and zinc concentrates are further processed to produce refined metal.

End uses

Silver is a precious metal with a wide range of uses including industrial applications (electronics, alloys and solders), in jewellery and as a financial asset.

Lead and zinc are the most widely used non-ferrous metals after copper and aluminium. Lead is mostly used in batteries, which account for 80 per cent of total consumption. Lead-acid batteries are used extensively in the automotive industry for starting-lighting-ignition, but increasingly as a source of motive power in electric vehicles.

Zinc is extensively used for the galvanisation of iron and steel to protect against corrosion, and also in alloys such as bronze and brass.

Trading and pricing

The reference price for silver has been the London Bullion Market Association, which is determined via a daily auction. The most significant paper contract trading market is the COMEX division of the New York Mercantile Exchange.

The most recognised reference prices for lead and zinc are LME daily cash settlements for deliverable metal of a minimum purity and particular chemistry. Lead and zinc also have active futures markets that are traded on the LME.

Silver, lead or zinc that is sold in concentrate form to refineries and smelters is typically sold on a 'payable metal' basis, based on reference prices described above, less a treatment or refining charge. These charges notionally represent the cost of producing refined metals; however, they are also influenced by the balance between concentrate production and available refining and smelting capacity.

Historical silver, lead and zinc pricing is provided in Annexure 5. Historical average prices realised by South32's silver, lead and zinc operations are provided in Section 7.1.

(b) Supply and demand

Global mine production for silver in 2013 was 820 Moz,⁸ with another 192 Moz sourced from scrap. The largest silver-producing countries are Mexico, Peru and China, accounting for about half of the total mine production.

Silver demand has benefited in recent years as investor appetite for the commodity as a store of value has increased. This also means that silver prices are vulnerable to macroeconomic conditions and market sentiment. Demand for physical silver in 2013 was 1.1 Boz.⁹ Given silver's role as a store of value, physical supply and demand fundamentals historical supply and demand charts have not been included in this document.

Global lead mine production in 2013 was 5.4 Mt in concentrate form.¹⁰ Over half of this supply came from China. A large volume of lead is recycled, with 6.0 Mt of secondary refined metal production recorded in 2013. Lead demand in 2013 was 11.1 Mt,¹¹ of which 45 per cent was from China.

Global zinc mine production in 2013 totalled 13.2 Mt, with approximately 36 per cent coming from China.¹² Zinc refined metal production in 2013 totalled 12.9 Mt, of which approximately 12.05 Mt was from primary sources, and 0.8 Mt from secondary sources. Zinc demand in 2013 was approximately 13.0 Mt, with China accounting for 44 per cent.

8 Source: The Silver Institute.

9 Source: The Silver Institute.

10 Source: International Lead Zinc Study Group.

11 Source: International Lead Zinc Study Group.

12 Source: International Lead Zinc Study Group.

Lead

Chart 6.11: Mine production (Mt, lead in concentrate)

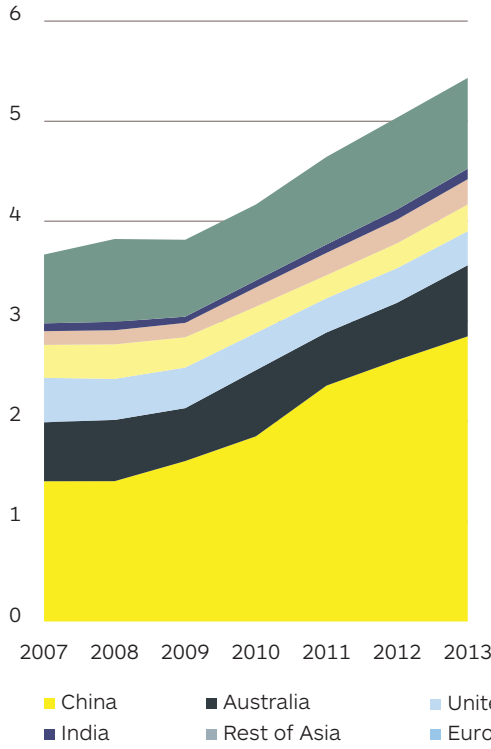
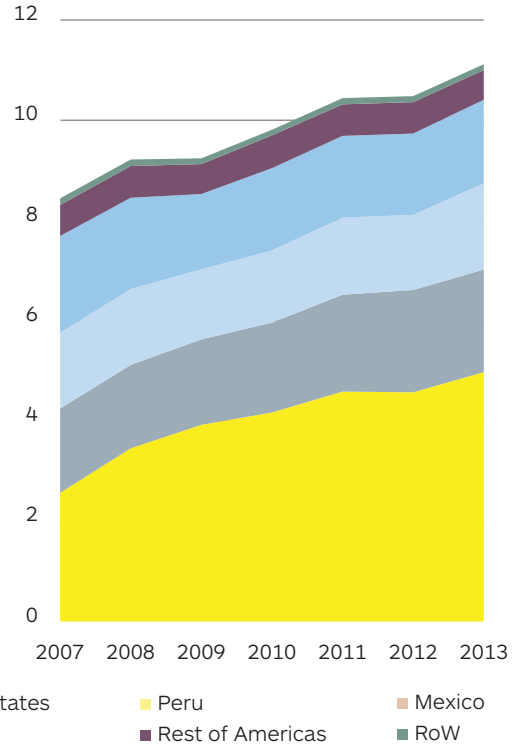

Chart 6.12: Refined lead demand (Mt)



Source: International Lead Zinc Study Group

Zinc

Chart 6.13: Mine production (Mt, zinc in concentrate)

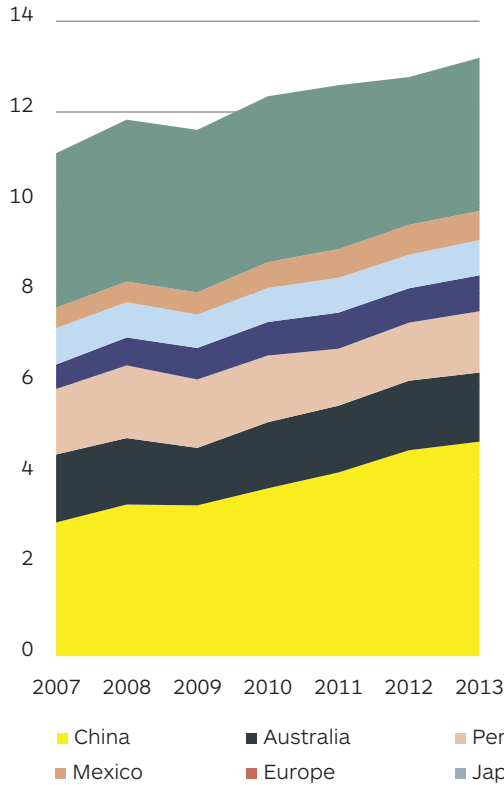
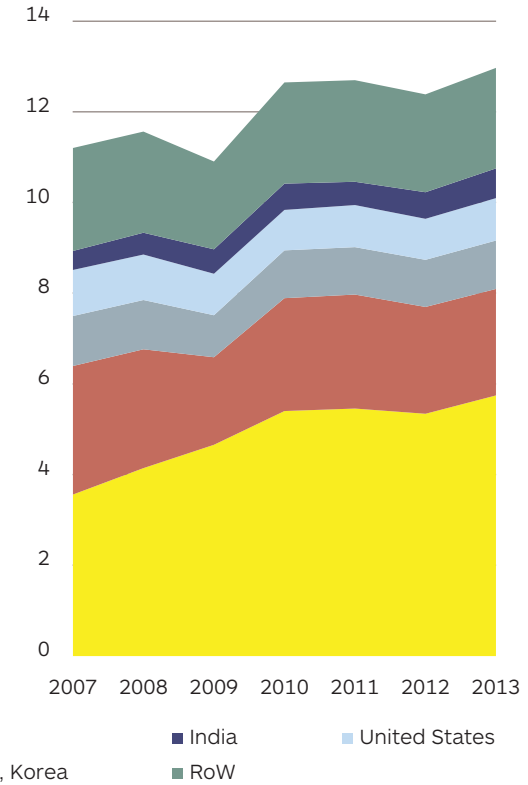

Chart 6.14: Refined zinc demand (Mt)



Source: International Lead Zinc Study Group

This page has been intentionally left blank.

7 SOUTH32 BUSINESS DESCRIPTION

7.1 SOUTH32 BUSINESSES

(a) Worsley Alumina

(1) Overview

Worsley Alumina is an integrated bauxite mining and alumina refining operation that is 86 per cent owned by South32. It is located in the southwest of Western Australia, Australia, and includes one of the largest and lowest-cost refineries in the world. Bauxite production in FY2014 was 18 Mt (100 per cent basis). The bauxite mine has a reserve life of 17 years. Alumina production in FY2014 was 4.6 Mt (100 per cent basis). The location of Worsley Alumina's operations is set out below:

Diagram 7.1: Location of Worsley Alumina's operations



An overview of Worsley Alumina is set out below:

Table 7.1: Worsley Alumina overview

Location	The Worsley Alumina bauxite mine is located near the town of Boddington, Western Australia, approximately 123 km southeast of Perth. The Worsley Alumina refinery is located 55 km northeast of Bunbury, Western Australia.
Ownership	Worsley Alumina is an unincorporated joint venture with South32 holding 86 per cent, Japan Alumina Associates (Australia) Pty Ltd holding 10 per cent and Sojitz Alumina Pty Ltd holding four per cent.
Operatorship	BHP Billiton Worsley Alumina Pty Ltd operates the Worsley Alumina bauxite mining operation and alumina refinery on behalf of South32.
Workforce	Worsley Alumina had on average approximately 1,900 FTE employees and contractors in FY2014.
History	Construction of the Worsley Alumina project commenced in 1980, with first alumina being produced in May 1984. Production began at 1.0 Mtpa (100 per cent basis) and has steadily increased through expansion projects, efficiency initiatives and new technology to reach a capacity of 4.6 Mtpa (100 per cent basis) in 2014 (South32's share 3.9 Mtpa). BHP Billiton's ownership in Worsley Alumina (which will be transferred to South32 as part of the internal restructure preceding the Demerger) stems from two acquisitions. The first of these was Billiton's initial acquisition of a 30 per cent interest in Worsley Alumina from The Shell Company of Australia in 1994. BHP Billiton undertook the second acquisition of a further 56 per cent interest from Alcoa Alumínio S.A. (Alcoa) in 2001.

Title, leases or options	All necessary mining leases are in place and are valid to various dates from 2024 to 2035. All mining leases are granted on 21 year renewable terms.
Resources and reserves	As at 30 June 2014, in 100 per cent terms, Worsley Alumina Measured, Indicated and Inferred Mineral Resource totalled 1,140 Mt at 31.4 per cent available alumina and 2.2 per cent of reactive silica grades. Worsley Alumina's Proved and Probable Ore Reserves were 295 Mt (100 per cent basis) at 31 per cent available alumina and 1.6 per cent of reactive silica grades. ^(a)
Mining and processing	<p>Bauxite mining at the Worsley Alumina bauxite mine is conducted by shallow multi-pit open-cut mining techniques which have been developed over the last 30 years to efficiently extract bauxite from the discrete, pod-like nature of the deposit.</p> <p>Worsley Alumina refinery produces alumina exclusively from ore that is sourced from the Worsley Alumina bauxite mine. The refinery uses the Bayer refining process to produce alumina.</p> <p>Key energy sources for the processing operation include coal fired boilers, third party on-site gas-fired steam power co-generation plant and third party leased on-site multifuel co-generation steam and power generation plant. Various long-term arrangements exist for the supply of coal from the Collie coal mine and gas and gas transportation via the Dampier to Bunbury Natural Gas Pipeline. Raw materials and final product are transported by rail.</p>
Logistics and marketing	<p>Bauxite ore is supplied from the Worsley Alumina bauxite mine to the Worsley Alumina refinery via a 51 km conveying system. Alumina from the Worsley Alumina refinery is railed to the Bunbury Port and loaded on ships for export to customers.</p> <p>In FY2014, 42 per cent of South32 Worsley Alumina's alumina sales were to South32's aluminium smelters in southern Africa (Hillside and Mozal Aluminium), to supply South32's equity share, and the remainder was supplied to aluminium smelters predominantly in the Middle East and the Pacific Basin.</p>
Overview of significant contracts	<p>Worsley Alumina is primarily powered by a mix of coal and natural gas with long-term arrangements in place. In 2014, Worsley Alumina entered into a 32 year lease for two multifuel co-generation units to generate steam and electricity.</p> <p>Worsley Alumina's gas supply is currently provided by affiliates of BHP Billiton Petroleum under two agreements, which will continue after the Demerger. These arrangements are on arm's-length terms and are due to expire during 2018 and 2023 respectively.</p> <p>Griffin Coal (owned by the Lanco Group) has supplied coal to Worsley Alumina under a long-term coal supply agreement for use by Worsley Alumina in steam and power generation. Griffin Coal did not supply coal to Worsley Alumina in December 2014 and January 2015 as a result of Griffin Coal's financial position. Griffin recommenced coal supply in February 2015, albeit at lower than contracted tonnage. Worsley Alumina separately also sources coal from Premier Coal and has increased the amount of coal sourced pursuant to these arrangements.</p> <p>Worsley Alumina is currently exploring available alternatives to sourcing coal for steam and power generation. Any new terms of coal (or other energy) supply are likely to be higher cost to South32 than the historic arrangements with Griffin Coal.</p>
Projects and developments	As at 31 December 2014, there were no planned material development projects being undertaken or shortly to be undertaken at Worsley Alumina.

(a) Mineral Resources and Ore Reserves above are based on the information in Section 7.2.

(2) Summary historical financial and operating information

A summary of operating metrics and financial information for the integrated operations is set out below:

Table 7.2: Worsley Alumina operating metrics

South32's share	6 months ended December		12 months ended June		
	H1 FY2015	H1 FY2014	FY2014	FY2013	FY2012
Alumina production (kt)	1,953	1,970	3,916	3,675	2,917
Alumina sales (kt)	1,943	1,858	3,864	3,677	2,928
Realised alumina sales price (US\$/t) ^(a)	335	304	318	307	339
Operating unit cost (US\$/t produced)	260	232	272	291	363

(a) Realised sales price is calculated as sales revenue divided by sales volume.

Table 7.3: Worsley Alumina financial summary

South32's share US\$M	6 months ended December		12 months ended June		
	H1 FY2015	H1 FY2014	FY2014	FY2013	FY2012
Sales revenue	651	565	1,229	1,130	992
Underlying EBITDA	143	108	162	60	(67)
Underlying EBIT	67	45	24	(115)	(194)
Net operating assets	3,413	2,862	3,418	2,868	5,105
Minor and maintenance capital expenditure	27	22	56	77	127
Major projects capital expenditure	-	-	-	77	773
Exploration expenditure	-	-	-	-	-
Exploration expensed	-	-	-	-	-

During FY2014, raw materials and consumables, energy and labour-related costs comprised 51 per cent, six per cent and 40 per cent of Worsley Alumina's operating cash costs respectively. The remaining cash costs included freight, secondary taxes and royalties, among other things.

(b) South Africa Aluminium

(1) Overview

South Africa Aluminium comprises Hillside Aluminium (Pty) Ltd (**Hillside**). Hillside owns (100 per cent) and operates an aluminium smelter located at Richards Bay, South Africa, approximately 200 km north of Durban.

Hillside is the largest aluminium smelter in the Southern Hemisphere and has a solid metal production capacity of 723 ktpa. Hillside solid metal production was 715 kt in FY2014.

Previously, South Africa Aluminium's operations included an aluminium smelter and casthouse owned by Billiton Aluminium SA (Pty) Ltd (**Bayside**). The Bayside smelter was closed in FY2014. An agreement to sell the assets comprising the Bayside casthouse, which produces aluminium slab products, has been reached and completion of the sale is subject to certain regulatory and other conditions, which are expected to be fulfilled during the first half of CY2015.

The location of South Africa Aluminium's operations is shown below:

Diagram 7.2: Location of South Africa Aluminium's operations

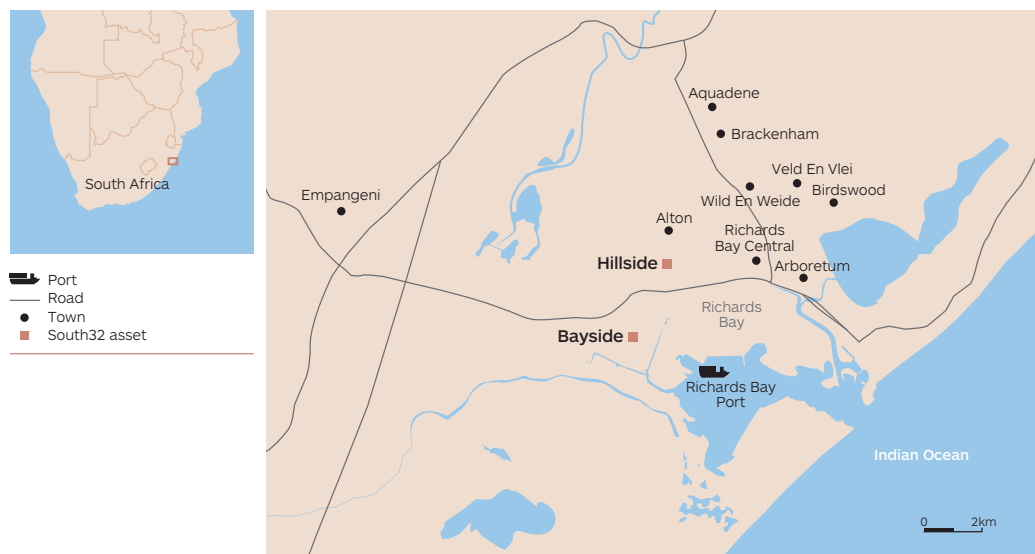

An overview of South Africa Aluminium is set out below:

Table 7.4: South Africa Aluminium overview

Location	Hillside is located at Richards Bay, Kwa-Zulu Natal, South Africa, approximately 200 km north of Durban.
Ownership	100 per cent owned by South32.
Operatorship	Operated by South32.
Workforce	In total, Hillside and Bayside had on average approximately 3,350 FTE employees and contractors in FY2014. Following the closure of the Bayside smelter, as at 31 December 2014, the number of FTE employees and contractors at Hillside and Bayside was 2,597 FTE employees and contractors.
History	The Hillside smelter was commissioned between June 1995 and June 1996 with a production capacity of 466 ktpa. In FY2004, the brownfield Hillside 3 expansion project increased metal production by 132 ktpa. Various improvement projects since then have increased Hillside's solid metal production capacity to 723 ktpa.
Title, leases or options	Hillside owns the freehold title to the property on which the smelter operates. Hillside holds leases from the Transnet National Port Authority (TNPA) over harbour facilities at Richards Bay Port.
Processing	Hillside processes approximately 1,400 ktpa of alumina that is imported from Worsley Alumina. The initial stage of the process involves the electrolytic reduction of alumina that has been dissolved in a molten electrolyte bath to produce liquid aluminium, which collects at the bottom of the specialised reaction vessels that are known as pots. The molten aluminium is then tapped out of the pots and transferred to the casthouse where it is cast into aluminium ingots. Hillside manufactures 22.7 kg primary aluminium ingots at better than P1020 quality (maximum 1,000 ppm silicon and maximum 2,000 ppm iron).
Logistics and marketing	Alumina and certain raw materials are imported through the Richards Bay Port. A portion of South32's share of alumina produced at Worsley Alumina is supplied to Hillside Aluminium, pricing for which is index based. In FY2014, Hillside exported approximately 80 per cent of its aluminium production in the form of primary aluminium ingot to customers located principally in western Europe and Asia. All export product is sold via South32 Marketing and is shipped through Richards Bay Port. The balance is sold into the domestic market, mainly to Hulamin under a long-term LME aluminium price-linked contract. All domestic product is transported by road to its South African domestic customers. Hillside has historically trucked approximately 96 ktpa liquid aluminium to the Bayside casthouse for conversion into aluminium slab products. Following the expected sale of the Bayside casthouse in CY2015, liquid metal will continue to be trucked to the new owners of the Bayside casthouse.

Overview of significant contracts	<p>Hillside sources power from Eskom, the South African Government-owned power utility, under long-term contracts. The price of electricity supplied to the Hillside Potline 1 and 2 is linked to the LME aluminium price and the South African rand/ US dollar exchange rate. The price of electricity supplied to the Hillside Potline 3 is South African rand based and linked to the South African and United States producer price indices. The electricity supply arrangements also include fully utilised 75 MW of power which is not covered by a long-term contract and is priced at the same tariff as other South African industrial power users. As stated in Section 2.2(c):</p> <ul style="list-style-type: none"> • Eskom has announced a national program of load shedding and has stated that the South African power system is likely to be constrained for the foreseeable future; • the National Energy Regulator of South Africa is reviewing the terms of electricity supply arrangements in respect of Hillside. <p>Hillside has three agreements with TNPA, the government port authority. These agreements are for the export stockyard facility, the liquid pitch terminal facility and the alumina and petcoke silo facilities. These agreements expire in CY2019.</p>
Projects and developments	<p>The engagement of a contractor is in progress to investigate the feasibility of introducing the AP3XLE technology enhancement at Hillside. AP3XLE is a commercially available technology aimed at increasing efficiency at smelters (AP3XLE). The benefits are optimisation of direct current energy consumption.</p>

(2) Summary historical financial and operating information

A summary of operating metrics and financial information for the integrated operations is set out below:

Table 7.5: South Africa Aluminium operating metrics

South32's share	6 months ended December		12 months ended June		
	H1 FY2015	H1 FY2014	FY2014	FY2013	FY2012
Aluminium production (kt)	356	415	804	761	719
Aluminium sales (kt) ^(a)	352	401	804	772	713
Realised sales price (US\$/t) ^(a)	2,338	1,985	2,007	2,154	2,309
Operating unit cost (US\$/t produced) ^(b)	1,747	1,716	1,771	2,089	2,303

(a) Volumes and prices do not include any third party trading that may be undertaken independently of the equity production. Realised sales price is calculated as sales revenue divided by sales volume.

(b) Total cost per tonne of aluminium produced.

Table 7.6: South Africa Aluminium financial summary

South32's share US\$M	6 months ended December		12 months ended June		
	H1 FY2015	H1 FY2014	FY2014	FY2013	FY2012
Sales revenue	823	796	1,614	1,663	1,646
Underlying EBITDA	201	84	190	73	(10)
Underlying EBIT	167	48	121	1	(83)
Net operating assets	1,195	1,399	1,195	1,382	1,528
Minor and maintenance capital expenditure	10	7	28	17	14
Major projects capital expenditure	-	-	-	-	-
Exploration expenditure	-	-	-	-	-
Exploration expensed	-	-	-	-	-

During FY2014, raw materials and consumables, energy (including fuel) and labour-related costs comprised 56 per cent, 22 per cent and 14 per cent of South Africa Aluminium's operating cash costs respectively. The remaining cash costs included freight, consumables and maintenance, among other things.

(c) Mozal Aluminium

(1) Overview

Mozal Aluminium is an aluminium smelter located 17 km from Maputo, Mozambique. Following implementation of the Demerger South32 will own 47.1 per cent of, and operate, Mozal Aluminium. The operation includes a dedicated berth and other port terminal facilities at Matola, the port of Maputo, which are also operated by South32. Mozal Aluminium produces standard aluminium ingots and its FY2014 production was 266 kt (South32's share). Mozal Aluminium is the only aluminium smelter in Mozambique and the second largest aluminium smelter in Africa.

The location of Mozal Aluminium's operations is shown below:

Diagram 7.3: Location of Mozal Aluminium's operations



An overview of Mozal Aluminium is set out below:

Table 7.7: Mozal Aluminium overview

Location	Mozal Aluminium is located at Industrial Free Zone of Beluluane Industrial Park, Maputo province, Mozambique. The site is 17 km from Maputo, the capital city of Mozambique.
Ownership	Mozal Aluminium is a joint venture in which South32 will hold 47.1 per cent, MCA Metals Holding GmbH holds 25.0 per cent, Industrial Development Corporation of South Africa Limited holds 24.0 per cent and the Government of the Republic of Mozambique holds 3.9 per cent (through preference shares).
Operatorship	Operated by South32.
Workforce	Mozal Aluminium had on average 1,950 FTE employees and contractors in FY2014.
History	Development of the Mozal Aluminium operation commenced in 1998 following a feasibility study undertaken by Billiton Plc. Production commenced in 2000 with a smelter capacity of 253 ktpa (100 per cent basis). In 2003, the Mozal Aluminium expansion project (Mozal 2) was commissioned and expanded the smelter's capacity to 566 ktpa (100 per cent basis).
Title, leases or options	Mozal Aluminium currently operates under a 50-year Investment Project Authorisation (Mozal IPA) that allows it to use the land for the operating plant and to access certain facilities within the Maputo harbour. The authorisation is renewable for a further 50 years provided Mozal Aluminium maintains effective production in accordance with the terms of the Mozal IPA.

Processing	<p>In FY2014 Mozal procured 1,072 kt of alumina that was imported from Worsley Alumina. 505 kt of that amount was procured by South32.</p> <p>The smelting process involves the electrolytic reduction of alumina that has been dissolved in a molten electrolyte bath to produce liquid aluminium in reaction pots. The molten aluminium, which collects at the bottom of the pots is then tapped out and transferred for casting into aluminium ingots.</p> <p>Mozal Aluminium has the capacity to produce 566 ktpa aluminium (100 per cent basis) and manufactures 23.7 kg ingots with a purity grade of at least 99.7 per cent. Mozal Aluminium utilises hydroelectric power generated by Hidroeléctric Cahora Bassa (HCB) situated on the Zambezi River in the northwest of Mozambique. HCB delivers power into the South African grid to the national electricity supplier, Eskom. Mozal Aluminium sources this power via Mozambique Transmission Company (Motraco).</p>
Logistics and marketing	<p>Mozal Aluminium operates a berth at the Matola Port, Maputo, which is located 15 km from the smelter.</p> <p>Alumina and key raw materials such as petroleum coke and liquid pitch are shipped to Matola Port via the same berth that is used by Mozal Aluminium to export aluminium.</p> <p>All raw materials and product are trucked to and from the Mozal Aluminium smelter to and from the port facilities.</p> <p>Most of Mozal Aluminium's aluminium is sold into Europe; however, a portion of its product is used domestically in Mozambique by Midal Cables International.</p>
Overview of significant contracts	<p>Mozal Aluminium sources power under an electricity supply agreement with Motraco, a transmission joint venture between Eskom and the national electricity utilities of Mozambique and Swaziland.</p> <p>Mozal Aluminium's port facilities are governed by a lease with the Company of Railways and Harbours of Mozambique. This lease covers the Matola harbour facilities consisting of a berth, storage silos, loading and unloading facilities, conveyor belts, roads, storage areas, parking and administration facilities located in the Maputo harbour area.</p> <p>Mozal Aluminium has recently agreed a long-term domestic aluminium metal supply agreement with Midal Cables International to supply 50,000 tonnes of aluminium ingots per year. Deliveries have recently commenced.</p>
Projects and developments	<p>The AP3XLE project technology referred to in Section 7.1(b) is also currently in selection phase for Mozal Aluminium.</p>

(2) Summary historical financial and operating information

A summary of operating metrics and financial information for the integrated operations is set out below:

Table 7.8: Mozal Aluminium operating metrics

South32's share	6 months ended December		12 months ended June		
	H1 FY2015	H1 FY2014	FY2014	FY2013	FY2012
Aluminium production (kt)	135	134	266	264	264
Aluminium sales (kt) ^(a)	137	142	276	264	265
Realised sales price (US\$/t) ^(a)	2,482	2,049	2,080	2,318	2,374
Operating unit cost (US\$/t produced)	1,867	2,045	1,962	2,201	2,189

(a) Volumes and prices do not include any third party trading that may be undertaken independently of the equity production. Realised sales price is calculated as sales revenue divided by sales volume.

Table 7.9: Mozal Aluminium financial summary

South32's share US\$M	6 months ended December		12 months ended June		
	H1 FY2015	H1 FY2014	FY2014	FY2013	FY2012
Sales revenue	340	291	574	612	629
Underlying EBITDA	88	17	52	31	51
Underlying EBIT	70	(1)	16	(3)	18
Net operating assets	628	634	627	669	777
Minor and maintenance capital expenditure	5	3	8	7	9
Major projects capital expenditure	-	-	-	-	-
Exploration expenditure	-	-	-	-	-
Exploration expensed	-	-	-	-	-

During FY2014, raw materials and consumables, energy (including fuel) and labour-related costs comprised 55 per cent, 29 per cent and 13 per cent of Mozal Aluminium's operating cash costs respectively. The remaining cash costs included freight, secondary taxes and royalties, among other things.

(d) Brazil Aluminium

(1) Overview

The Brazil Aluminium business comprises South32's interests in:

- MRN Mine (14.8 per cent owned by South32);
- Alumar consortium, which is comprised of an alumina refinery (36 per cent owned by South32) and aluminium smelter (40 per cent owned by South32) (together with certain interests in ancillary facilities and lands).

South32's Brazilian Aluminium business interests are held through its wholly-owned subsidiary, BMSA. Mineração Rio do Norte S.A. (**MRN**) is a Brazilian corporation, which owns the MRN Mine, a bauxite mine located in the Trombetas region in the state of Pará, Brazil. The mine is an open-cut operation with a capacity of 18 Mtpa of washed bauxite (100 per cent basis). The MRN Mine's FY2014 production was 17.7 Mt of bauxite (100 per cent basis) and the MRN Mine has a reserve life of six years. The majority of the bauxite produced from the MRN Mine is sold to shareholders in MRN and their related parties under long-term contracts. South32 is currently entitled to a total annual base volume of 2.4 Mtpa and a maximum of 2.7 Mtpa of bauxite under its contracts with MRN, which South32 currently supplies to the Alumar refinery.

Alumar comprises an alumina refinery with a nominal capacity of 3.5 Mtpa (100 per cent basis) and aluminium smelter with a nominal capacity of 440 ktpa (100 per cent basis). These operations and their integrated port facilities are located at São Luís, in the state of Maranhão, Brazil. FY2014 saleable production was 1,262 kt of alumina (South32's share) and 104 kt of aluminium (South32's share). During FY2014, approximately 16 per cent of Alumar's alumina production was used to feed the Alumar smelter, while the remainder was exported.

South32 sources electricity for Alumar under two long-term supply agreements with Eletronorte (a Brazilian power generation concessionaire). Since FY2013, South32 has generated revenue through the sale of surplus electricity into the transmission grid with a total of 1,188 GWh sold in FY2014.

(2) MRN Mine description

The location of the MRN Mine is set out below:

Diagram 7.4: Location of the MRN Mine’s operations

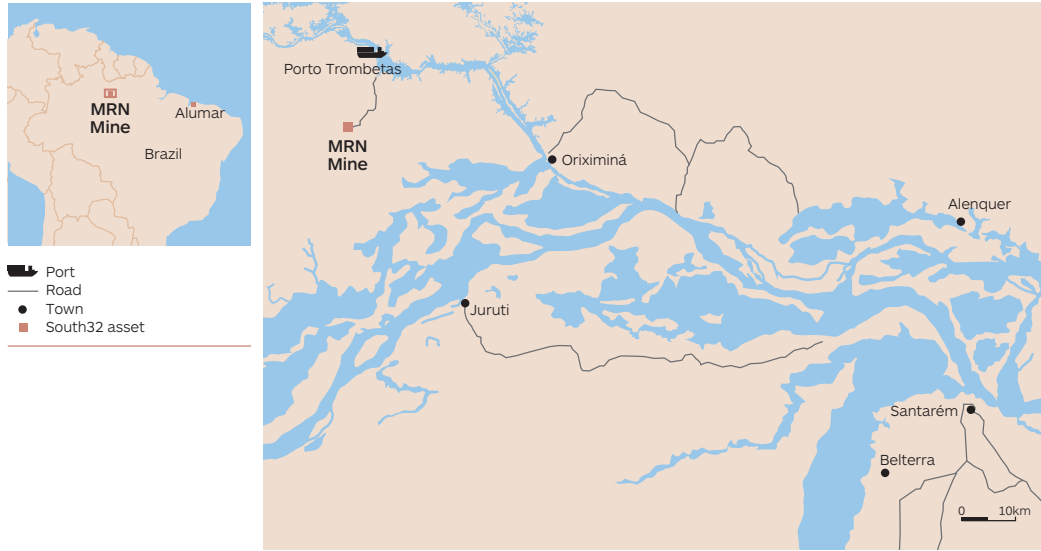

An overview of the MRN Mine is set out below:

Table 7.10: MRN Mine overview

Location	The MRN Mine is located approximately 40 km from Porto Trombetas, which is 880 km from Belém, the capital of Pará, Brazil.
Ownership	The MRN Mine is owned by MRN, which is a Brazilian corporation in which South32 holds a 14.8 per cent interest, Alcoa and its affiliates ^(a) hold 18.2 per cent, Vale S.A. (Vale) holds 40 per cent, Alcan Alumina Ltda (Rio Tinto Alcan) holds 12 per cent, Companhia Brasileira de Alumínio S.A. holds 10 per cent, and Norsk Hydro Brasil Ltda holds five per cent.
Operatorship	Independent joint venture company.
Workforce	MRN had on average approximately 3,400 FTE employees and contractors in FY2014.
History	<p>MRN was incorporated in 1967 by Rio Tinto Alcan and established in 1974 as a joint venture involving Rio Tinto Alcan, Vale and other shareholders. Mine operations commenced in 1979 and the first shipment from the MRN Mine was in 1979.</p> <p>The adjacent Cruz Alta Project, initially associated with Alcoa and Billiton Group companies, was consolidated with the Trombetas Project in 1992 to form the MRN Mine.</p> <p>In 2003 and 2007, expansions of the operation increased production capacity to 18 Mtpa of washed bauxite (100 per cent basis).</p>
Title, leases or options	<p>MRN holds 44 mining leases, all of which are mining concessions issued under the Brazilian Mining Code. The mining leases are grouped into a single mining unit (Grupamento Mineiro/Mining Group), under no. 950.000/1997. These leases cover an area of 143,000 ha.</p> <p>With respect to the environmental licensing process, MRN has already applied for environmental licences for new exploration of areas surrounding the MRN Mine, which requires authorisation for environmental studies. However, there is a civil investigation in respect of certain of these environmental licence applications which has resulted in delays in the environmental permitting of some of MRN's exploration activities until consultation with potentially affected local traditional communities is undertaken. MRN has engaged in negotiations with the communities who filed the initial complaint to resolve this issue.</p>

Resources and reserves	As at 30 June 2014, in 100 per cent terms, the MRN Mine's total Mineral Resources (washed) were 527 Mdmt at 50.2 per cent of available alumina and 4.2 per cent of reactive silica grades. Total Ore Reserves (washed) were 98 Mdmt (100 per cent basis) at 49.4 per cent of available alumina and 4.6 per cent of reactive silica grades. ^(b)
Mining and processing	The MRN Mine is an open-cut strip mining operation that has an 18 Mtpa installed bauxite capacity. Mined ore is hauled to primary crushers and then transported by conveyor belt to the beneficiation plant, where it is washed and classified by granulometry. Bauxite fines are recovered by cyclone and filtering. On-site power is provided by two thermoelectric power plants, with installed power rating of 60.6 MW.
Logistics and marketing	Bauxite is transported to Porto Trombetas, a river port, via a 28 km rail line that connects the mine area to the port. All bauxite is transported from the port via ship to customers, including the Alumar members' share.
Overview of significant contracts	MRN currently sells the majority of its production to its shareholders and their related parties, with sales primarily governed by long-term contracts that establish annual quantities and similar sales terms for each shareholder. The quantities are confirmed annually and may vary slightly. From the current bauxite production, 70 per cent is shipped to Alunorte and Alumar, two of the main Brazilian refineries, and the remainder is exported, mainly to refineries located in the North Atlantic Ocean seaboard. In recent times, price reductions have applied under these sale agreements due to the quality of bauxite grades supplied. However, for South32, the sale price achieved by MRN becomes an input cost into the operations at Alumar, such that variations in the price of bauxite supplied by MRN have a limited net financial impact on South32.
Projects and developments	The MRN Mine's current reserve base supports mining until 2021. MRN is currently considering extending the mine's life to approximately 2043. This extension will require MRN's shareholders to agree on the optimal expansion configuration and to potentially contribute to the substantial capital expenditure.

(a) Alcoa Alumínio S.A., Alcoa World Alumina LLC and Alcoa World Alumina Brasil Ltda.

(b) Mineral Resources and Ore Reserves above are based on the information in Section 7.2.

(3) Alumar description

The location of Alumar's operations is set out below:

Diagram 7.5: Location of Alumar's operations

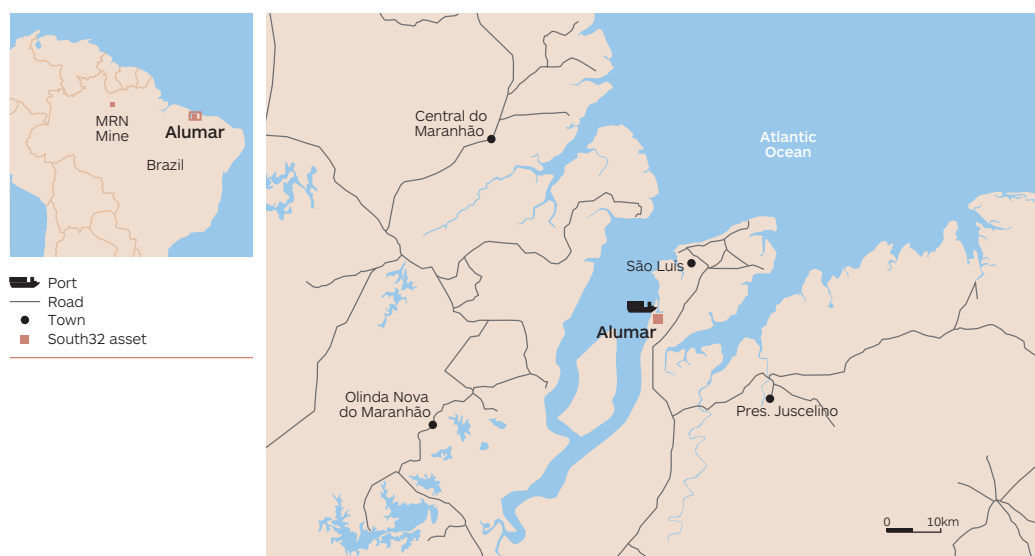

An overview of Alumar is set out below:

Table 7.11: Alumar overview

Location	Alumar is located at São Luís, Maranhão, Brazil.
Ownership	<p>The Alumar alumina refinery is an unincorporated joint venture with South32 holding 36 per cent, Alcoa and its affiliates holding 54 per cent and Rio Tinto Alcan holding 10 per cent.</p> <p>The Alumar aluminium smelter is an unincorporated joint venture with South32 holding 40 per cent and Alcoa holding 60 per cent.</p>
Operatorship	Alcoa operates both the refinery and smelter.
Workforce	Alumar had on average approximately 2,750 FTE employees and contractors in FY2014.
History	<p>Alumar commenced operations in 1984 with refining capacity (on a 100 per cent basis) of 0.9 Mtpa and smelter capacity of 110 ktpa. Since then, several expansions have been implemented, including (on a 100 per cent basis):</p> <ul style="list-style-type: none"> • in 1986, smelter capacity was increased from 110 to 250 ktpa as Line II of the smelter commenced operations; • in 2006, smelting capacity was increased to 440 ktpa as Line III of the smelter commenced operations; • in 2009, the refinery was substantially expanded, increasing capacity to 3.5 Mtpa.
Title, leases or options	<p>All assets are held on land owned by Alumar or occupied by Alumar pursuant to public deeds of right of easement executed in 1982 and 1983 for undetermined terms with the State of Maranhão, Brazil.</p> <p>The creation of an environmental conservation area adjoining the Alumar site has been considered by federal and state governments, which may lead to changes in permitting procedures in respect of the area, as well as to delays in the permitting procedures already in progress. However, at this stage there is no official proposal regarding the creation of the conservation area.</p>
Mining and processing	<p>Alumar refinery</p> <p>Bauxite ore is refined using the Bayer refining process in which bauxite is mixed with a caustic soda solution and transferred to a digestion vessel, where it is heated under pressure. The resultant solution is clarified before aluminium hydrate is precipitated. The filter cake is subsequently fed into calciners where it is roasted to produce alumina.</p> <p>Alumar smelter</p> <p>The smelting process involves the electrolytic reduction of alumina that has been dissolved in a molten electrolyte bath to produce liquid aluminium in reaction pots. The molten aluminium, which collects at the bottom of the pots, is then tapped out and transferred for casting into aluminium ingots.</p> <p>Production from potlines II and III is currently suspended due to market conditions reducing overall annual capacity to 124 ktpa (100 per cent basis), and potline I operations are subject to ongoing review having regard to market conditions.</p>
Logistics and marketing	<p>Alumar refinery</p> <p>Alumar's port facilities provide the primary entry point for raw materials and also serve as an export facility for alumina. The majority of alumina produced at the Alumar refinery is exported via the port to customers.</p> <p>The port includes two terminals at São Marcos Bay, which have capacity to receive 76 kt (gross tonne) ships.</p> <p>Alumar smelter</p> <p>South32's share of aluminium produced at Alumar is largely sold in the Brazilian domestic market on a Free Carrier basis where the customer is responsible for contracting and paying for transportation.</p>

Overview of significant contracts

South32 acquires bauxite to feed the Alumar refinery under six long-term bauxite off-take agreements with MRN, each with an expiry and contracted base supply amount as follows:

Expiry date	Bauxite to be supplied (ktpa)
1 January 2018	800
1 January 2020	115
1 January 2020	700
1 January 2023	500
1 January 2032	86
1 January 2033	200

MRN has agreed to negotiate in good faith during the final year of each agreement with a view to entering into new off-take arrangements for the supply of similar volumes of bauxite. If bauxite cannot be sourced from the MRN Mine (noting the current reserve base at the MRN Mine supports mining until 2021, although expansion options may exist), alternative supply of bauxite may need to be sourced for Alumar, which may be under different terms than under South32's current contracts with MRN.

South32 acquires electricity for Alumar from Eletronorte (a Brazilian power generation concessionaire) under two long-term contracts (one for the smelter and the other for the refinery) which will expire in 2024. As noted in Section 2.2(c) the risk of electricity rationing occurring has increased recently in Brazil. The bauxite is transported from the MRN Mine to Alumar under arrangements with specialised freight companies, including Empresa de Navegação Elcano S.A.

Projects and developments

A preliminary concept study has been prepared with a view to 'debottlenecking' the refinery (improving supply chain and processing efficiency and increasing the capacity of the refinery) to increase capacity.

(4) Summary historical financial and operating information

A summary of operating metrics and financial information for South32's combined Brazil Aluminium businesses is set out below:

Table 7.12: Brazil Aluminium operating metrics

South32's share	6 months ended December		12 months ended June		
	H1 FY2015	H1 FY2014	FY2014	FY2013	FY2012
Alumina production (kt)	680	633	1,262	1,205	1,235
Aluminium production (kt)	26	63	104	154	170
Alumina sales (kt)	694	598	1,248	1,275	1,201
Aluminium sales (kt)	25	62	104	164	163
Realised alumina sales price (US\$/t) ^(a)	323	293	300	296	324
Realised aluminium sales price (US\$/t) ^(a)	2,360	1,968	2,000	2,061	2,252
Alumina operating unit cost (US\$/t produced) ^(b)	203	254	239	275	258
Aluminium operating unit cost (US\$/t produced) ^(c)	4,692	2,462	2,644	2,416	2,576

(a) Realised sales price is calculated as sales revenue divided by sales volume.

(b) Includes cost of acquiring bauxite from MRN.

(c) Includes cost of alumina transferred from Alumar refinery to the Alumar smelter at the alumina production cost. Excludes revenue from sales of surplus electricity into the transmission grid, which is included in Other Income in Table 7.13.

Table 7.13: Brazil Aluminium financial summary

South32's share US\$M	6 months ended December		12 months ended June		
	H1 FY2015	H1 FY2014	FY2014	FY2013	FY2012
Sales Revenue	268	266	529	637	660
<i>Alumina</i>	224	175	374	378	389
<i>Aluminium</i>	59	122	208	338	367
<i>Intra-segment elimination</i>	(15)	(31)	(53)	(79)	(96)
Other income ^(a)	117	36	121	31	3
Underlying EBITDA	140	35	127	44	3
<i>Alumina</i>	86	25	54	47	70
<i>Aluminium</i>	54	10	73	(3)	(67)
Underlying EBIT	101	(7)	44	(40)	(80)
<i>Alumina</i>	56	(8)	(10)	(17)	7
<i>Aluminium</i>	45	1	54	(23)	(87)
Net operating assets	938	1,010	968	1,031	1,144
<i>Alumina</i>	750	848	752	869	949
<i>Aluminium</i>	188	162	216	162	195
Minor and maintenance capital expenditure	5	7	9	6	12
Major projects capital expenditure	-	-	-	-	-
Exploration expenditure	-	-	-	-	-
Exploration expensed	-	-	-	-	-

(a) Other income primarily comprises revenue generated from the sale of surplus electricity into the transmission grid.

During FY2014, raw materials and consumables, energy (including fuel) and labour-related costs comprised 53 per cent, 28 per cent and 16 per cent of Brazil Aluminium's operating cash costs respectively. The remaining cash costs included freight, secondary taxes and royalties, among other things.

(e) South Africa Energy Coal

(1) Overview

South Africa Energy Coal, which is 90 per cent owned by South32, operates the Khutala, Klipspruit, Wolvekrans and Middelburg mines in the Witbank region in the Mpumalanga province, South Africa. South Africa Energy Coal's mines are open-cut, other than the Khutala underground bord and pillar mine. South Africa Energy Coal also owns a 21 per cent interest in RBCT.

South Africa Energy Coal is the third-largest exporter and the fifth-largest domestic supplier of energy coal in South Africa. In FY2014, it produced 30.4 Mt of energy coal (100 per cent basis), of which approximately 55 per cent was sold to Eskom. The remaining production was exported, predominantly to India and China. As at 30 June 2014, the reserve lives of South Africa Energy Coal's mines ranged from six years at Khutala to 23 years at Middelburg.

The location of the South Africa Energy Coal mines is shown below.

Diagram 7.6: Location of South Africa Energy Coal's operations

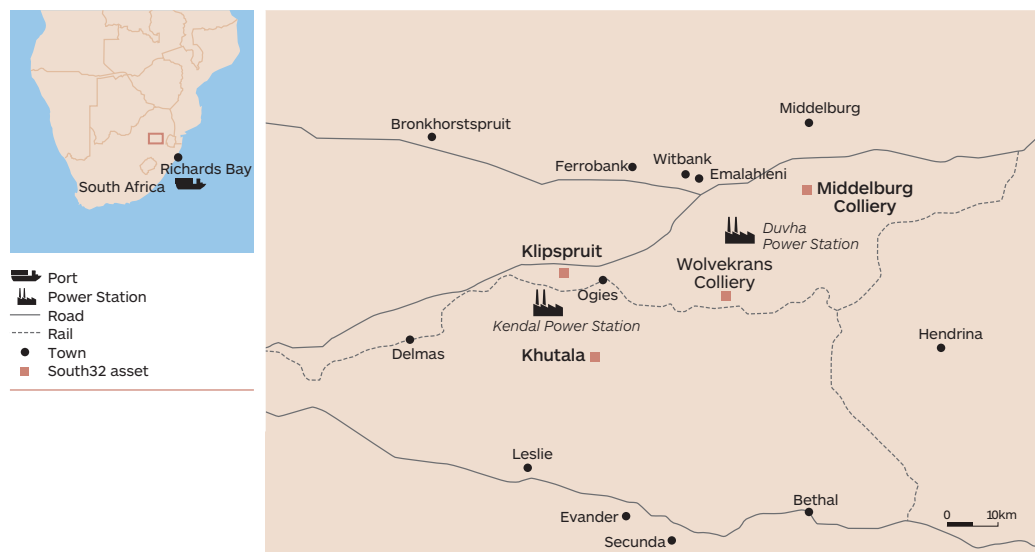

An overview of South Africa Energy Coal is provided below:

Table 7.14: South Africa Energy Coal overview

Location	<p>South Africa Energy Coal's mines are all located within the Witbank coalfield in the Mpumalanga province.</p> <p>Khutala mine is located approximately 40 km southwest of the town of Witbank and 100 km east of Johannesburg.</p> <p>Klipspruit mine is located approximately 30 km southwest of the town of Witbank and 120 km east of Johannesburg.</p> <p>The Wolvekrans Middelburg complex is located approximately 20 km southeast of the town of Witbank and 170 km east of Johannesburg.</p>
Ownership	<p>South Africa Energy Coal is 90 per cent owned by South32, two per cent owned by its employees through an Employee Share Ownership Plan (ESOP) and eight per cent owned by a BBBEE consortium led by Pembani Group (Pty) Limited (Pembani). The interests owned by the ESOP and BBBEE consortium were acquired using vendor finance, with the loans repayable to South32 via distributions attributable to these parties, pro rata to their share in South Africa Energy Coal.</p> <p>From an accounting perspective, until these loans are repaid, South32's interest in Underlying EBITDA generated by South Africa Energy Coal is 100 per cent. Following repayment of the loans, from an accounting perspective, South32's interest in Underlying EBITDA will be 90 per cent.</p>
Operatorship	Operated by South32.
Workforce	South Africa Energy Coal had on average approximately 10,000 FTE employees and contractors in FY2014.
History	<p>The history of the currently operating mines is summarised below:</p> <ul style="list-style-type: none"> • The Middelburg mine commenced production in 1982 and in 2008 subsumed the Douglas mine (which had commenced operation in 1979). Douglas and Middelburg were previously owned through the Douglas Tavistock Joint Venture (DTJV), in which BHP Billiton had an 84 per cent share and a subsidiary of Glencore Plc (Glencore) had a 16 per cent share. The DTJV was amended in 2008 such that it ceased being a production joint venture. The Middelburg complex was split to form the Middelburg and Wolvekrans mines during 2011, which now operate as a combined complex. • Khutala commenced as an underground bord and pillar mine in 1984, while its open-cut operations started in 1996. • Klipspruit was initially a truck and shovel mini-pit operation, which commenced in 2003. Dragline operations started in June 2005. <p>Since 2000, South Africa Energy Coal has completed a number of coal mine and infrastructure-related transactions with South African junior miners in addition to its combined empowerment transaction, which included a BBBEE transaction with Pembani and an ESOP. These were in line with South African empowerment legislation, as well as the requirements set out in the Mining Charter as published in the Mineral and Petroleum Resources Development Act of 2002 (South Africa).</p>

Title, leases or options	<p>South Africa Energy Coal holds new order mining rights that provide it with the exclusive right to mine minerals for a period of 30 years from the date of grant. Each of the mining rights has a right of renewal for a further 30 years, subject to compliance with the terms and conditions of the existing mining right. These obligations include the development and implementation of Social and Labour Plans, which South Africa Energy Coal has prepared and submitted and is awaiting approval.</p> <p>South Africa Energy Coal's new order mining rights were issued between October and December 2011 and cover each of South Africa Energy Coal's four operating mines as well as associated exploration areas and infrastructure.</p> <p>The new order mining rights in respect of the Khutala and Klipspruit mines are held independently by South Africa Energy Coal.</p> <p>The Wolvekrans Middelburg complex comprises of four new order mining rights. One of the new order mining rights is held independently by South Africa Energy Coal. The remaining three are currently held jointly by South Africa Energy Coal (84 per cent) and Glencore (16 per cent). The joint ownership of these three new order mining rights traces back to the DTJV agreement. South Africa Energy Coal and Glencore are pursuing an amendment to the joint ownership of the mining rights such that South Africa Energy Coal and Glencore would have independent new order mining rights for their respective interests. South Africa Energy Coal and Glencore currently mine and operate their respective areas independently and for their own account.</p> <p>South Africa Energy Coal applied for a mining right over an area referred to as Pegasus in May 2013. It also holds prospecting rights over a number of other areas.</p>
Resources and reserves	<p>As at 30 June 2014, in 100 per cent terms, South Africa Energy Coal's Measured, Indicated and Inferred Coal Resources totalled 5,170 Mt. South Africa Energy Coal's Proved and Probable Coal Reserves and Marketable Coal Reserves were 583 Mt and 435 Mt respectively (100 per cent basis).^(a)</p>
Mining and processing	<p>South Africa Energy Coal's mining and processing methods vary by mine.</p> <p>Khutala mine produced 9.7 Mt of energy coal in FY2014 (100 per cent basis). Most of the production was from underground bord and pillar operations and approximately 1.5 Mt was produced from a small open-cut area (100 per cent basis). The mined coal is crushed at two crushers, which have a combined nominal capacity in excess of 12 Mtpa (100 per cent basis).</p> <p>Klipspruit is a single dragline, multi seam open-cut mine that is combined with a truck and shovel mini pit. Run-of-mine (ROM) coal is processed at the Phola Coal Processing Plant, which is a 50:50 joint venture with a subsidiary of Anglo American Plc. South Africa Energy Coal's share of the plant's nominal capacity is in excess of 7 Mtpa. Klipspruit produced 7.3 Mt of energy coal in FY2014.</p> <p>Wolvekrans is an open-cut mine actively mining five pits, while Middelburg is an open-cut mine actively mining two pits. The Wolvekrans Middelburg complex includes tips and crushing plants, two export wash plants, one middlings wash plant and a de-stoning plant with a combined nominal capacity in excess of 17 Mtpa. The Wolvekrans Middelburg complex produced 13.4 Mt of energy coal in FY2014 (100 per cent basis).</p> <p>Power supplied to the mines is sourced from Eskom under long-term contracts. Potable water is supplied to the various operations by Eskom (43 ML) and Phola Plant (2 ML), for a total of 45 ML each month. All process water is sourced from pollution control dams with a combined capacity of 1,830 ML. All operations have potable water supply contracts with Eskom.</p>
Logistics and marketing	<p>Logistics and marketing arrangements vary for each of the operations that make up South Africa Energy Coal.</p> <p>The Khutala mine is located adjacent to Eskom's Kendal power station. The entire Khutala resource, except for coal mined from the No. 5 coal seam (approximately 235 kt in FY2014), is dedicated to supplying Kendal. This coal is loaded directly onto a conveyor system which feeds the Kendal power station and is sold to Eskom on a cost-plus basis.</p> <p>Klipspruit produces a 6,000 kcal/kg and a 4,800 kcal/kg export product. After processing, the coal is railed 611 km to RBCT via the Transnet rail link. Klipspruit coal is exported, predominantly to India and China.</p> <p>The Wolvekrans Middelburg complex produces both export and domestic product. Export production can be blended to suit market requirements with 6,000 kcal/kg and 4,800 kcal/kg products currently produced. The complex utilises a 558 km Transnet rail link to export coal via RBCT. Export coal is predominantly shipped to India and China. Domestic production is transported by conveyor to Eskom's Duvha coal-fired power station, which is located adjacent to the Middelburg mine.</p>

Overview of significant contracts	<p>South Africa Energy Coal has two long-term coal supply agreements (CSAs) in place with Eskom. The first CSA is for the supply of energy coal from the Khutala mine to Eskom's Kendal power station that expires in 2033. The second CSA is for the supply of energy coal from the Wolvekrans Middelburg complex to Eskom's Duvha Power Station that expires in 2034.</p> <p>South Africa Energy Coal recently entered into a rail agreement with Transnet that expires in March 2024. As part of the negotiation process, South Africa Energy Coal agreed to relinquish up to five per cent of its rail entitlement for allocation to emerging miners. The risk associated with South Africa Energy Coal failing to obtain adequate allocation of rail capacity in the future is set out in Section 2.2(b).</p>
Projects and developments	<p>Further development opportunities have been identified to extend the mine lives of the existing Khutala and Klipspruit mining domains. Studies relating to these projects are at various stages of investigation and are outlined in Section 5.4(e).</p> <p>South Africa Energy Coal continues to evaluate options to extract value from its broader portfolio. Assessments have been made or are currently underway in relation to Pegasus, as well as Leandra and Naudesbank, areas over which South Africa Energy Coal has prospecting rights.</p>

(a) Mineral Resources and Ore Reserves above are based on the information in Section 7.2.

(2) Summary historical financial and operating information

A summary of financial and operating metrics for South Africa Energy Coal are set out below (excluding third party sales):

Table 7.15: South Africa Energy Coal operating metrics

100 per cent terms	6 months ended December		12 months ended June		
	H1 FY2015	H1 FY2014	FY2014	FY2013	FY2012
Energy coal production (kt)	16,525	14,973	30,384	31,627	33,279
Domestic sales (kt) ^(a)	9,137	8,354	16,330	18,130	19,620
Export sales (kt) ^(a)	7,913	6,591	13,298	13,935	14,106
Realised domestic sales price (US\$/t) ^(a)	23	22	22	23	27
Realised export sales price (US\$/t) ^(a)	60	69	66	75	97
Operating unit cost (US\$/t produced)	36	39	35	42	44

(a) Volumes and prices do not include any third party trading that may be undertaken independently of the equity production. Realised sales price is calculated as sales revenue divided by sales volume.

Table 7.16: South Africa Energy Coal financial summary

100 per cent terms US\$M	6 months ended December		12 months ended June		
	H1 FY2015	H1 FY2014	FY2014	FY2013	FY2012
Sales revenue ^(a)	683	639	1,247	1,458	1,894
Underlying EBITDA	83	54	197	115	416
Underlying EBIT	(9)	(44)	4	(96)	226
Net operating assets	1,014	1,313	989	1,334	1,425
Minor and maintenance capital expenditure	50	17	59	115	137
Major projects capital expenditure	8	5	6	18	25
Exploration expenditure	–	–	–	–	–
Exploration expensed	–	–	–	–	–

(a) Includes domestic and export sales revenue.

During FY2014, raw materials and consumables, energy (including fuel) and labour-related costs comprised 51 per cent, eight per cent and 37 per cent of South Africa Energy Coal's operating cash costs respectively. The remaining cash costs included freight, secondary taxes and royalties, among other things.

(f) **Illawarra Metallurgical Coal**

(1) **Overview**

Illawarra Metallurgical Coal, which is 100 per cent owned by South32, owns and operates three underground metallurgical coal mines, Appin, West Cliff and Dendrobium, and two preparation plants, West Cliff Coal Preparation Plant (**CPP**) and Dendrobium CPP. These operations are all located in the southern coalfields of New South Wales, Australia, near the city of Wollongong and approximately 75 km to 90 km southwest of Sydney and between 8 km and 38 km from Port Kembla. Metallurgical coal is mined from the Bulli and Wongawilli seams and is crushed, screened and washed at the two CPPs, which have a combined processing nominal capacity of 12.5 Mtpa of raw coal. Product coal is then trucked to either Port Kembla or to BlueScope Steel's Port Kembla steelworks. In FY2014, Illawarra Metallurgical Coal produced a total of 6.0 Mt of metallurgical coal and 1.5 Mt of energy coal. As at 30 June 2014, the reserve lives of the Illawarra Metallurgical Coal mines were 25 years at Appin, two years at West Cliff and nine years at Dendrobium.

The location of Illawarra Metallurgical Coal's operations is shown below:

Diagram 7.7: Location of Illawarra Metallurgical Coal's operations

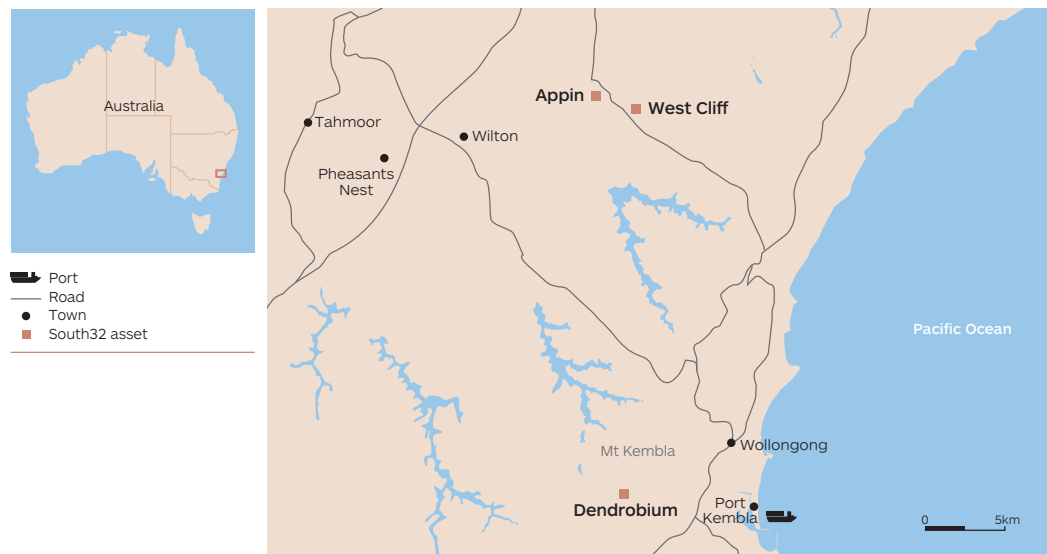

An overview of Illawarra Metallurgical Coal is set out below:

Table 7.17: Illawarra Metallurgical Coal overview

Location	<p>Illawarra Metallurgical Coal is located in the Illawarra region of New South Wales, Australia, near the city of Wollongong and approximately 75 km to 90 km southwest of Sydney. Distances between the mines and the port facility at Port Kembla are between 8 km and 38 km.</p> <p>Illawarra Metallurgical Coal's operations are in proximity to the surrounding suburban areas of Illawarra, Wollondilly and Macarthur, and have the potential to impact on nearby infrastructure, environmental features and residential areas. The business has a strong community presence, which is supported by a comprehensive stakeholder engagement management plan, which includes structured community investment initiatives.</p>
Ownership	100 per cent owned by South32.
Operatorship	Operated by South32.

Workforce	<p>Illawarra Metallurgical Coal had on average approximately 2,500 FTE employees and contractors in FY2014.</p> <p>Employment terms for some employees in the Illawarra Metallurgical Coal business are governed by collective employment agreements, some of which have expired and are under renegotiation or are due to expire within the near future. South32 intends to engage with the relevant employees on the renewal of these agreements:</p>												
	<table border="1"> <thead> <tr> <th data-bbox="432 409 667 436">Enterprise agreement</th> <th data-bbox="978 409 1054 436">Expiry</th> </tr> </thead> <tbody> <tr> <td data-bbox="432 450 612 477">Dendrobium mine</td> <td data-bbox="978 450 1078 477">April 2014</td> </tr> <tr> <td data-bbox="432 490 603 517">Dendrobium CPP</td> <td data-bbox="978 490 1070 517">July 2015</td> </tr> <tr> <td data-bbox="432 530 671 557">West Cliff mine and CPP</td> <td data-bbox="978 530 1070 557">July 2015</td> </tr> <tr> <td data-bbox="432 571 544 598">Appin mine</td> <td data-bbox="978 571 1070 598">July 2015</td> </tr> </tbody> </table>	Enterprise agreement	Expiry	Dendrobium mine	April 2014	Dendrobium CPP	July 2015	West Cliff mine and CPP	July 2015	Appin mine	July 2015		
Enterprise agreement	Expiry												
Dendrobium mine	April 2014												
Dendrobium CPP	July 2015												
West Cliff mine and CPP	July 2015												
Appin mine	July 2015												
History	<p>Illawarra Metallurgical Coal has operated in the Illawarra region for 80 years. Over that time it has produced metallurgical coal from a number of mines. Of the currently operating mines:</p> <ul style="list-style-type: none"> • Appin mine commenced production in 1962 and commissioned its first longwall operation in 1969; • West Cliff mine commenced production in 1976; • the current Dendrobium mine commenced production in 2005. 												
Title, leases or options	<p>Illawarra Metallurgical Coal holds a number of coal leases, mining leases and exploration titles.</p> <p>Consolidated Coal Leases (CCL) covering the primary operating areas for, and granted to, Illawarra Metallurgical Coal cover a total of 43,071 ha. The key CCLs include:</p> <table border="1"> <thead> <tr> <th data-bbox="432 1021 608 1048">Operating mines</th> <th data-bbox="826 1021 868 1048">CCL</th> <th data-bbox="978 1021 1054 1048">Expiry</th> </tr> </thead> <tbody> <tr> <td data-bbox="432 1061 635 1088">Appin and West Cliff</td> <td data-bbox="826 1061 868 1088">767</td> <td data-bbox="978 1061 1035 1088">2029</td> </tr> <tr> <td data-bbox="432 1102 528 1128">West Cliff</td> <td data-bbox="826 1102 868 1128">724</td> <td data-bbox="978 1102 1035 1128">2031</td> </tr> <tr> <td data-bbox="432 1142 564 1169">Dendrobium¹</td> <td data-bbox="826 1142 868 1169">768</td> <td data-bbox="978 1142 1177 1191">Pending application for further 21 years²</td> </tr> </tbody> </table> <p>1 Also covers the Cordeaux mine, which was closed in 2001.</p> <p>2 South32 does not consider there is any basis for non-renewal and the rights granted under the expired lease can continue until the application has been resolved.</p>	Operating mines	CCL	Expiry	Appin and West Cliff	767	2029	West Cliff	724	2031	Dendrobium ¹	768	Pending application for further 21 years ²
Operating mines	CCL	Expiry											
Appin and West Cliff	767	2029											
West Cliff	724	2031											
Dendrobium ¹	768	Pending application for further 21 years ²											
Resources and reserves	<p>As at 30 June 2014, Illawarra Metallurgical Coal Measured, Indicated and Inferred Coal Resources totalled 1,306 Mt. Illawarra Metallurgical Coal's Proved and Probable Coal Reserves and Marketable Coal Reserves were 208 Mt and 166 Mt respectively.^(a)</p>												
Mining and processing	<p>Appin, West Cliff and Dendrobium are all longwall mines and the existing level of equipment as at 30 June 2014 supports an annual ROM capacity of 4 Mtpa, 3 Mtpa and 5 Mtpa, respectively. Production at Illawarra Metallurgical Coal is approximately 80 per cent metallurgical coal and 20 per cent energy coal.</p> <p>All coal produced by Illawarra Metallurgical Coal is washed at one of the two CPPs, with coal from:</p> <ul style="list-style-type: none"> • both Appin and West Cliff mines being washed at the West Cliff CPP, which has a nominal capacity of 7.5 Mtpa of raw coal; • Dendrobium mine being transported via rail for washing at the Dendrobium CPP, which has a nominal capacity of 5 Mtpa of raw coal and is located at the BlueScope Steel site at Port Kembla. <p>Electricity is sourced from the New South Wales electricity grid. Illawarra Metallurgical Coal sources water for Appin and Dendrobium mines from Sydney Water. The West Cliff mine and CPP have their own water supply and water is supplied to the Dendrobium CPP pursuant to lease arrangements entered into with BlueScope Steel.</p>												

Logistics and marketing

Coal is hauled by road to the Port Kembla Coal Terminal for export to customers globally. Coal is also sold domestically and, in the case of BlueScope Steel, coal is delivered from the Dendrobium CPP by conveyor or truck to the blending yard at BlueScope Steel's Port Kembla steelworks.

In FY2014, 63 per cent of coal produced at Illawarra Metallurgical Coal was exported and 37 per cent was sold domestically.

Illawarra Metallurgical Coal utilises the Port Kembla Coal Terminal for shipping coal to customers globally. Illawarra Metallurgical Coal is one of six equal-share consortium partners in, and currently the manager of, Port Kembla Coal Terminal Ltd. Port Kembla Coal Terminal Ltd's right to operate the Port Kembla Coal Terminal is granted under a lease agreement with Port Kembla Port Corporation. The lease agreement for the coal terminal expires in 2030.

Port Kembla Coal Terminal is required to undertake a necessary restoration and compliance program. During the next five years South32 is expecting to provide a non-interest bearing shareholder loan for its share of these works. The final contribution required from South32 for this restoration and compliance program is subject to actual usage of the facility over the five year period of the project and consortium partner approval and funding.

Overview of significant contracts

Illawarra Metallurgical Coal has in place a number of contractual arrangements with BlueScope Steel. These include:

- a long-term agreement that governs the lease of the Dendrobium coal washery buildings located within BlueScope Steel's Port Kembla steelworks expiring in 2052;
- the rail operations agreement that governs the Kemira Valley rail link which connects the Dendrobium mine to the Dendrobium CPP (i.e. coal washery), which is located within BlueScope Steel's Port Kembla steelworks, that can be terminated by either party with six months' notice;
- a shared services agreement that governs the services that BlueScope Steel provides to Illawarra Metallurgical Coal in respect of the coal washery located at BlueScope Steel's Port Kembla steelworks and Illawarra Metallurgical Coal operations. Each service provided will continue indefinitely until either party terminates a particular service and the services in relation to the coal washery will terminate when the lease for the coal washery buildings terminates;
- a long-term contract pursuant to which Illawarra Metallurgical Coal supplies metallurgical coal to BlueScope Steel's steelworks located at Port Kembla, expiring in 2032. Under the coal supply agreement:
 - the coal price is based on a pricing formula, which is calculated by reference to a basket of underlying contracts from Illawarra Metallurgical Coal and BHP Billiton-Mitsubishi Alliance coal sales. At the time that the parties entered into the agreement, the price of coal under these contracts was set on an annual benchmark basis. In recent years, pricing of the coal sold pursuant to these underlying contracts has moved towards index pricing. The contract pricing mechanism for future periods is under discussion with BlueScope Steel and BlueScope Steel has made certain claims in relation to historical pricing and the quality of coal supplied under the contract (see Section 2.1(f));
 - BlueScope Steel has pre-emptive rights and a purchase option in respect of certain disposals of Illawarra Metallurgical Coal entities and assets. However, these rights will not be triggered by the Demerger or disposals of shares in South32 once its shares are admitted to an official list of a recognised stock exchange, including in the context of a change of control.

At the time of the demerger of BlueScope Steel from BHP Billiton, BHP Billiton agreed to indemnify BlueScope Steel in respect of certain potential past and future environmental liabilities arising from Illawarra Metallurgical Coal's mines and related infrastructure that will form part of South32's assets. As a result of the allocation of liabilities in the Demerger agreements as summarised in Section 14.4, South32 will assume liability for any potential liabilities arising out of the indemnity given in favour of BlueScope Steel. BlueScope Steel has not made any claims pursuant to this indemnity since it was agreed in May 2002.

Coal seam gas extracted from Illawarra Metallurgical Coal's mines is supplied to a power station owned and operated by Energy Developments Limited (EDL). The gas is converted into electricity and then sold by Illawarra Metallurgical Coal to Endeavour Energy. Illawarra Metallurgical Coal's tolling services agreement with EDL and power supply agreement with Endeavour Energy are due to expire in 2016. South32 expects that these contracts will be renegotiated prior to expiry.

Projects and developments	<p>In June 2012, the BHP Billiton Board approved a US\$845 million investment to sustain operations at Illawarra Metallurgical Coal by establishing a replacement mining area at Appin mine (Appin Area 9 project). The replacement area will have a production capacity of 3.5 Mtpa and will sustain Illawarra Metallurgical Coal's production capacity at 9 Mtpa product coal. The Appin Area 9 project was 77.5 per cent complete at 31 December 2014 and is expected to be operational in 2016, at which point it will replace production at the West Cliff mine.</p> <p>Beyond the Appin Area 9 project, Illawarra Metallurgical Coal has undertaken a number of assessments to determine preferred options for mine life extension projects to sustain production at or above current levels. Opportunities exist (subject to receipt of requisite permits) within currently held mining and exploration lease areas but outside existing development consents.</p>
----------------------------------	--

(a) Mineral Resources and Ore Reserves above are based on the information in Section 7.2.

(2) Summary historical financial and operating information

A summary of operating metrics and financial information for Illawarra Metallurgical Coal is set out below:

Table 7.18: Illawarra Metallurgical Coal operating metrics

South32's share	6 months ended December		12 months ended June		
	H1 FY2015	H1 FY2014	FY2014	FY2013	FY2012
Metallurgical coal production (kt)	3,858	2,614	5,974	6,664	6,621
Energy coal production (kt)	880	741	1,539	1,278	1,305
Metallurgical coal sales (kt)	3,447	2,579	5,921	7,032	6,233
Energy coal sales (kt)	799	677	1,623	1,410	1,098
Realised metallurgical coal sales price (US\$/t) ^(a)	110	141	130	167	255
Realised energy coal sales price (US\$/t) ^(a)	57	69	67	79	101
Operating unit cost (US\$/t produced)	64	101	99	124	111

(a) Realised sales price is calculated as sales revenue divided by sales volume.

Table 7.19: Illawarra Metallurgical Coal financial summary

South32's share US\$M	6 months ended December		12 months ended June		
	H1 FY2015	H1 FY2014	FY2014	FY2013	FY2012
Sales revenue ^(a)	425	410	878	1,287	1,701
Underlying EBITDA	120	70	135	302	818
Underlying EBIT	20	(8)	(35)	154	659
Net operating assets	1,534	1,313	1,384	1,238	1,058
Minor and maintenance capital expenditure	108	67	110	80	148
Major projects capital expenditure	72	106	199	277	166
Exploration expenditure	2	3	5	7	14
Exploration expensed	2	3	5	7	14

(a) Includes metallurgical coal and energy coal sales revenue.

During FY2014, raw materials and consumables, energy (including fuel) and labour-related costs comprised 22 per cent, six per cent and 49 per cent of Illawarra Metallurgical Coal's operating cash costs respectively. The remaining cash costs included freight, secondary taxes and royalties, among other things.

(g) Australia Manganese

(1) Overview

GEMCO is a manganese mining operation located in the Northern Territory, Australia. Following implementation of the Demerger, GEMCO will be 60 per cent owned by South32. It is the largest and one of the lowest-cost manganese ore producers in the world. Its attributes include high-grade ore, open-cut mining operations, its own port facilities located at Milner Bay, 16 km from mining operations, and its close proximity to Asian export markets. GEMCO, whose FY2014 production of manganese ore was 4,776 kt (100 per cent basis), has a reserve life of 11 years.

TEMCO, a wholly-owned subsidiary of GEMCO, is a manganese alloy plant located in Tasmania, Australia. TEMCO is a medium-sized producer of HCF₂Mn, SiMn and sinter using ore shipped from GEMCO, primarily using hydroelectric power. Production of manganese alloy in FY2014 was 269 kt (100 per cent basis).

(2) GEMCO description

The location of GEMCO operations is shown below:

Diagram 7.8: Location of GEMCO's operations



An overview of GEMCO is set out below:

Table 7.20: GEMCO overview

Location	GEMCO is located on Groote Eylandt, Northern Territory, Australia, approximately 16 km from the town of Alyangula.
Ownership	South32 will hold a 60 per cent interest in GEMCO and Anglo American Plc holds the remaining 40 per cent.
Operatorship	Operated by South32.
Workforce	GEMCO had on average approximately 900 FTE employees and contractors in FY2014. The employment of some of the employees at GEMCO is governed by the Groote Eylandt Mining Company Enterprise Bargaining Agreement 2012, which expired on 1 March 2015. South32 intends to engage with the relevant employees and their representatives in relation to the renewal of this agreement.
History	GEMCO commenced mining at Groote Eylandt in 1964 under BHP Limited ownership. A crushing and wet screening plant was subsequently commissioned. The beneficiation plant was commissioned in 1972 at a 1.0 Mtpa capacity (100 per cent basis) and has since undergone a series of expansions. The most recent of these expansions was the GEMCO Expansion Project, which was completed in 2013 and increased GEMCO's capacity from 4.2 Mtpa to 4.8 Mtpa (100 per cent basis) through the introduction of a dense media circuit by-pass facility. The expansion also addressed key infrastructure constraints by increasing road and port capacity to 5.9 Mtpa (100 per cent basis), creating 1.1 Mtpa of additional infrastructure capacity for future expansions.

Title, leases or options	<p>Current mining licences (MLN 951-953,956-961) cover an area of 8,340 ha and are valid until 2031. In addition to the mining licences, GEMCO is the leaseholder for special purpose leases that provide rights for the provision of township, infrastructure services and port facilities.</p> <p>GEMCO holds two exploration leases on Groote Eylandt that are the subject of an ongoing resource extension study (ELR 28161-2). These cover an area of 4,414 ha and are valid until November 2015. South32 intends to renew these leases and potentially seek conversion to a mining lease.</p>
Resources and reserves	<p>As at 30 June 2014, in 100 per cent terms, GEMCO's Measured, Indicated and Inferred Mineral Resources comprised a ROM component which totalled 175 Mt at 44.8 per cent manganese product and a yield of 48 per cent and a series of sand tailings stockpiles of 15 Mt at 20.7 per cent manganese head grade (being the average grade of ore delivered to a process for mineral extraction). GEMCO's Proved and Probable Ore Reserves were 94 Mt (100 per cent basis) at 44.6 per cent manganese and a yield of 58 per cent.^(a)</p>
Mining and processing	<p>GEMCO is an open-cut strip mining operation, which includes crushing, screening, washing and dense media separation. It produces lump and fines products with a 4.8 Mtpa capacity (100 per cent basis).</p> <p>Power to the site is provided by on-site diesel generation.</p>
Logistics and marketing	<p>Ore is transported 16 km from the concentrator by road train to GEMCO's port at Milner Bay where it is exported.</p> <p>Approximately 90 per cent of ore product from GEMCO is sold directly to export markets, with the remaining ore sold to the TEMCO smelter.</p>
Projects and developments	<p>The US\$139 million Premium Concentrate Project (PC02) (US\$83.4 million South32's share), approved in August 2014, is in the early stage of execution. PC02 is expected to complete by the end of FY2016 and ramp up to full production of 0.5 Mtpa in FY2017, thereby increasing GEMCO's capacity from 4.8 Mtpa to 5.3 Mtpa (100 per cent basis). This capacity expansion will be achieved by the construction of a standalone processing facility near the existing concentrator to produce a premium concentrate product for export sale. The expansion also involves an update to port infrastructure to handle the blending of premium concentrate with existing ore fines products.</p> <p>South32 is in the early stages of assessing projects which have the potential to improve efficiency at GEMCO's operations and is exploring areas which have the potential to extend the GEMCO mine life.</p>

(a) Mineral Resources and Ore Reserves above are based on the information in Section 7.2.

(3) TEMCO description

The location of TEMCO's operations is shown below:

Diagram 7.9: Location of TEMCO's operations



An overview of TEMCO is provided below:

Table 7.21: TEMCO overview

Location	TEMCO is located at Bell Bay, Tasmania, Australia on an industrial estate approximately 4 km from George Town.
Ownership	TEMCO is wholly-owned by GEMCO, which is itself owned in a joint venture in which South32 will hold 60 per cent and Anglo American Plc holds 40 per cent.
Operatorship	Operated by South32.
Workforce	TEMCO had on average approximately 300 FTE employees and contractors in FY2014.
History	<p>TEMCO's operations were established by BHP in 1962 at the Bell Bay site, where it had access to a sheltered deep water port and cheap hydroelectric power.</p> <p>TEMCO's first furnace was commissioned in 1962. In 1966, TEMCO began to process GEMCO manganese ore. Three additional furnaces were commissioned in 1966 (Furnace No. 2), 1976 (Furnace No. 5) and 1977 (Furnace No. 3).</p> <p>Operations have been subject to a number of improvements since the 1970s. More recently, in 2001, TEMCO installed its first high conductivity freeze lining at Furnace No. 1, which enabled the furnace to operate at higher loads. Freeze lining has been installed during subsequent rebuilds of the other furnaces, with Furnace No. 5 being the last one to be converted to freeze lining in September 2009.</p>
Title, leases or options	The current ferroalloy facility is located on three freehold titles held by TEMCO having a total stated area of 104.1 ha. TEMCO also leases portions of the nearby wharf and foreshore areas. Under these arrangements, TEMCO has priority use of No. 3 Wharf and holds a lease over an area for haulage, access and training facilities, which expires in 2029.
Processing	<p>TEMCO produces HCFeMn (150 ktpa capacity) and SiMn (120 ktpa capacity). Sinter production (325 ktpa capacity) is predominantly consumed for internal alloy production, with any excess sold.</p> <p>Smelting of manganese ore and manganese sinter to produce SiMn and HCFeMn is conducted within refractory lined circular submerged arc furnaces. TEMCO operates a duplex process which means that the FeMn slag produced contains approximately 32 per cent manganese. The slag is then used as a primary feed in SiMn production.</p> <p>The majority of TEMCO's power needs are met by hydroelectric power. The remainder of TEMCO's power needs are generated on-site.</p>
Logistics and marketing	<p>TEMCO has priority use of a berth at the Bell Bay wharf, under a long-term lease, for its shipping requirements. Raw materials that are not sourced locally in Tasmania are shipped to TEMCO via the Bell Bay wharf. The same wharf is used by TEMCO to ship its manganese alloy products to customers.</p> <p>TEMCO is a party to marketing contracts in Australia and New Zealand. TEMCO distributes its products through a distribution agreement with Samancor AG (a manganese joint venture entity owned by South32 (60 per cent) and Anglo American Plc (40 per cent)). Currently, alloy production is exported to more than 28 customers in 12 countries. Approximately 10 per cent of TEMCO's products are supplied directly to steel customers in Australia and New Zealand.</p> <p>Section 2.1(c) sets out details of the petition filed with the United States Department of Commerce and the United States International Trade Commission in February 2015, requesting the imposition of antidumping duties on silicomanganese imports of Australian origin (of which TEMCO is the only producer).</p>
Overview of significant contracts	TEMCO sources power (a critical aspect of its operations) from Hydro Tasmania. TEMCO has recently extended its current agreement with Hydro Tasmania until 2024. Pricing is fully variable based on load consumption.
Projects and developments	No projects that would be material to South32 are currently being considered at TEMCO.

(4) Summary historical financial and operating information

A summary of operating metrics and financial information for the integrated operations is set out below:

Table 7.22: Australia Manganese operating metrics

100 per cent terms	6 months ended December		12 months ended June		
	H1 FY2015	H1 FY2014	FY2014	FY2013	FY2012
Manganese ore production (kt)	2,499	2,438	4,776	5,027	4,306
Manganese alloy production (kt)	139	123	269	234	198
Manganese ore sales (kt) ^(a)	2,432	2,523	5,063	4,578	4,428
External customers	2,159	2,332	4,591	4,100	4,046
TEMCO	273	191	472	478	382
Manganese alloy sales (kt) ^(a)	129	117	276	227	229
Realised manganese ore sales price (US\$/t) ^(a)	185	231	219	227	211
Realised manganese alloy sales price (US\$/t) ^(a)	1,140	983	1,025	1,282	1,384
Ore operating unit cost (US\$/t produced)	103	135	130	119	140
Alloy operating unit cost (US\$/t produced) ^(b)	906	967	974	1,000	1,601

(a) Volumes and prices do not include any third party trading that may be undertaken independently of the equity production. Realised sales price is calculated as sales revenue divided by sales volume.

(b) Includes the cost of the manganese ore acquired by TEMCO from GEMCO at market prices.

Table 7.23: Australia Manganese financial summary

100 per cent terms US\$M	6 months ended December		12 months ended June		
	H1 FY2015	H1 FY2014	FY2014	FY2013	FY2012
Sales revenue ^(a)	566	677	1,308	1,257	1,204
Manganese Ore	451	584	1,107	1,040	936
Manganese Alloy	147	115	283	291	317
Intra-segment elimination	(32)	(22)	(82)	(74)	(49)
Underlying EBITDA	215	252	505	499	335
Manganese Ore	194	256	484	442	335
Manganese Alloy	21	(4)	21	57	-
Underlying EBIT	162	216	414	436	282
Manganese Ore	147	225	404	392	293
Manganese Alloy	15	(9)	10	44	(11)
Net operating assets	890	887	825	846	621
Manganese Ore	750	731	697	702	451
Manganese Alloy	140	156	128	144	170
Minor and maintenance capital expenditure	49	25	76	135	126
Major projects capital expenditure	8	33	32	136	87
Exploration expenditure	3	3	5	4	-
Exploration expensed	3	3	5	4	-

(a) As per accounting policies, revenues referring to sales from GEMCO to TEMCO are eliminated as part of the consolidation.

During FY2014, raw materials and consumables, energy (including fuel) and labour-related costs comprised 20 per cent, 13 per cent and 37 per cent of Australia Manganese's operating cash costs respectively. The remaining cash costs included freight, secondary taxes and royalties, among other things.

(h) South Africa Manganese

(1) Overview

South Africa Manganese comprises Hotazel Mines owned by Hotazel Manganese Mines Proprietary Ltd (**Hotazel**) and Metalloys. South32 has an effective 44.4 per cent ownership of the Hotazel Mines, and Metalloys is 60 per cent owned and operated by South32.

South32 operates the Mamatwan open-cut mine and the Wessels underground mine of Hotazel Mines. In FY2014, the total manganese ore production was 3,526 kt (100 per cent basis). Wessels has a reserve life of 46 years and Mamatwan has a reserve life of 18 years.

The Metalloys operation is located approximately 50 km south of Johannesburg, South Africa. Metalloys is one of the largest manganese alloy producers in the world and produces HCFEMn and MCFEMn. FY2014 production of manganese alloy was 377 kt.

South Africa Manganese also holds an indirect interest in United Manganese of Kalahari mine, through a 38 per cent share of Majestic Silver Trading (Pty) Ltd.

The location of Hotazel Mines and Metalloys operations is shown below:

Diagram 7.10: Location of Hotazel Mines and Metalloys' operations



(2) Hotazel Mines description

An overview of Hotazel Mines is set out below:

Table 7.24: Hotazel Mines overview

Location	Hotazel Mines is located in the Northern Cape province of South Africa near the town of Kuruman, approximately 600 km from Johannesburg.
Ownership	<p>South32 holds a 60 per cent interest in Samancor Holdings (Pty) Ltd (Samancor) and Anglo American Plc holds the remaining 40 per cent.</p> <p>Samancor indirectly owns 74 per cent of Hotazel, giving South32 an ownership interest of 44.4 per cent. The remaining 26 per cent of Hotazel is owned by the following BBBEE entities as a result of transactions entered into between 2007 and 2009 (some of which were funded by vendor loans):</p> <ul style="list-style-type: none"> • Ntsimbintle Mining (Pty) Ltd (9 per cent); • Iziko Mining (Pty) Ltd (5 per cent); • NCAB Resources (Pty) Ltd (7 per cent); • The HMM Education Trust (5 per cent). <p>For accounting purposes, South32 will report a 54.6 per cent effective interest until the vendor loans are repaid.</p>
Operatorship	Operated by South32.
Workforce	Hotazel had on average approximately 2,100 FTE employees and contractors in FY2014.
History	<p>Samancor was established in 1926 and was listed on the JSE a year later as SA Manganese Ltd.</p> <p>Exploration started in the Kalahari Manganese Field in the 1950s. Mamatwan commenced with production during 1964 and Wessels during 1973.</p> <p>In 1975, SA Manganese Ltd merged with Amcor Ltd, giving rise to the present name. Samancor was subsequently acquired by a 60:40 joint venture between Billiton and Anglo American Plc and de-listed in 1998.</p>

Title, leases or options	<p>Hotazel is the holder of two mining licences (Mamatwan and Wessels) and one prospecting right (Hotazel York), namely the:</p> <ul style="list-style-type: none"> • Mamatwan mining right (Right No. 04/2006) covers an area of 1,103 ha and is valid until 5 October 2035; • Wessels mining right (Right No. 03/2006) covers an area of 1,069 ha and is valid until 5 October 2035; • Hotazel York prospecting right, which covers 146 ha, was renewed on 17 July 2014 and is valid for another three years in line with the Mineral and Petroleum Resources Development Act 2002 (South Africa). Upon completion of the prospecting work and the necessary mining studies, an application for a mining right can be lodged should positive decision be made to do so.
Resources and reserves	<p>As at 30 June 2014, in 100 per cent terms, Mamatwan's Measured, Indicated and Inferred Resource totalled 110 Mt at 35.1 per cent manganese content. Mamatwan's Proved and Probable Reserves were 64 Mt at 37.3 per cent manganese content.</p> <p>Wessels' Measured, Indicated and Inferred Resource totalled 140 Mt at 42.4 per cent manganese content (100 per cent basis). Wessels' Proved and Probable Reserves were 69 Mt at 42.2 per cent manganese content (100 per cent basis).^(a)</p>
Mining and processing	<p>Approximately 75 per cent of the ore processed at the Mamatwan and Wessels mines results in export saleable product. The remainder of the ore is converted to FeMn alloy at the Metallurgy plant.</p> <p>Mamatwan is an open-cut mining operation with a capacity of approximately 3.5 Mtpa ROM (100 per cent basis). Mined ore is processed into a saleable product through a crushing and wet screening operation, with some ore undergoing further processing by dense media separation and sintering. During beneficiation, the average grade of ore is increased from approximately 37 per cent Mn to approximately 46 per cent Mn.</p> <p>Wessels is an underground bord and pillar operation with a current capacity of approximately 1.2 Mtpa of ROM production (100 per cent basis). Primary crushing of ore takes place underground, while secondary crushing forms part of the surface operations. ROM ore is washed and screened on the surface to produce various quality products.</p> <p>Power to Mamatwan and Wessels is provided by the South Africa national power supplier, Eskom.</p>
Logistics and marketing	<p>The Hotazel Mine's ore is distributed to domestic customers by rail and road. Ore for the export market is transported to three ports where it is shipped predominantly to Asia and Europe. These ports are:</p> <ul style="list-style-type: none"> • Port Elizabeth, which is operated by Transnet operated port and is located approximately 1,000 km from the Hotazel Mines, which handles products from both mines; • Durban's port, which is privately operated by Bulk Connections, a business unit of the Bidvest Group, and is located approximately 1,200 km from the Hotazel Mines; • Saldanha Multi-Purpose Terminal, which is a Transnet operated port and is located approximately 900 km from the Hotazel Mines. <p>Rail and port capacity is constrained and given current rail constraints, a portion of ore is currently transported via road to Durban.</p> <p>Transnet has approved an expansion for ore export via the port of Coega, which will create additional capacity of 16 Mtpa for bulk ore exports by 2019 for the manganese mining sector. This expansion is expected to be underpinned by long-term take or pay contracts.</p> <p>The risk associated with South Africa Manganese failing to obtain adequate allocation of rail capacity in the future is set out in Section 2.2(b).</p>
Overview of significant contracts	<p>The Transnet Manganese Export Capacity Allocation (MECA) contract is a take or pay rail contract that provides rail and port services through Port Elizabeth. Transnet is in the process of finalising new export capacity allocations for the next five years (MECA2), which may provide additional export options. On 30 September 2014, notification was received from Transnet that the allocation under MECA2 would be 1.45 Mtpa, which is sufficient for South32's current requirements. The MECA2 contract is expected to be concluded in the second half of FY2015.</p>

Projects and developments	<p>The central block development project at Wessels is being progressed in two phases. The first phase of the project was commissioned in December 2013 at a cost of US\$92 million (100 per cent basis) and comprised the construction of the ventilation shaft and development of the associated underground ventilation network.</p> <p>The second phase of the project will complete infrastructure required to expand the mine to 1.5 Mtpa ROM (100 per cent basis) and comprises the development of a ROM infrastructure handling system for the central block, the development and equipping of underground workshops, including materials handling design, procurement and installation. The project is currently in execution and the spend for the half year ended 31 December 2014 was US\$7.5 million (total approved investment of approximately US\$31 million on a 100 per cent basis).</p>
----------------------------------	--

(a) Mineral Resources and Ore Reserves above are based on the information in Section 7.2.

(3) **Metalloys description**

An overview of Metalloys is set out below:

Table 7.25: Metalloys overview

Location	The Metalloys plant is located in the Gauteng province of South Africa, near the town of Meyerton. It is approximately 50 km south of Johannesburg.
Ownership	<p>South32 holds a 60 per cent interest in Samancor and Anglo American Plc holds the remaining 40 per cent.</p> <p>Samancor owns 100 per cent of Metalloys. South32 therefore has an effective interest of 60 per cent in Metalloys.</p>
Operatorship	Operated by South32.
Workforce	Metalloys had on average approximately 1,550 FTE employees and contractors in FY2014. This includes 138 FTE employees providing support to both the Hotazel Mines and Metalloys.
History	<p>Samancor's corporate history is set out in Section 7.1(h)(2).</p> <p>The Metalloys smelter was established in 1951 with the construction of seven small furnaces at the South plant complex to produce SiMn. Subsequent to this, two 75 MVA furnaces at North plant and an 81 MVA furnace at West plant were built to produce HCFeMn. In 1997, an oxygen blown converter was built at West plant which can further process HCFeMn into MCFeMn. In 2013, an additional 81 MVA furnace was commissioned to replace the small energy intensive SiMn furnaces which were decommissioned.</p>
Title, leases or options	Samancor is the owner of the land on which the Metalloys smelter operates, which is situated on the farm Kookfontein 545, IQ registration division, Gauteng Province.
Mining and Processing	Metalloys is one of the largest FeMn alloy producers in the world and currently operates four electric arc furnaces with the capacity to produce in excess of 450 ktpa HCFeMn. A portion of this HCFeMn can be further processed to produce up to 116 ktpa MCFeMn. Key inputs into the alloying process include approximately 1 Mtpa of manganese ore from the Hotazel Mines, 220 kt of reductants, 70 kt of fluxes and electricity supplied by Eskom. Approximately 20 MW to 30 MW of the electricity demand is generated using furnace off-gasses.
Logistics and marketing	Metalloys exports most of its production via two ports in South Africa: Richards Bay Port, which handles about 80 per cent of Metalloys export tonnages, and Durban port, which handles the remaining tonnage. Alloys are transported to port by road and rail. Metalloys exports alloys to customers located predominantly in the United States, Europe and Asia. Alloys are distributed to domestic customers by road.
Overview of significant contracts	Samancor entered into an electricity supply agreement with Eskom in 2013. The pricing is based on the pricing for large industrial electricity customers in South Africa.
Projects and developments	No projects that would be material to South32 are currently being considered at Metalloys.

(4) Summary historical financial and operating information

A summary of operating metrics and financial information for the integrated operations is set out below:

Table 7.26: South Africa Manganese operating metrics

100 per cent terms	6 months ended December		12 months ended June		
	H1 FY2015	H1 FY2014	FY2014	FY2013	FY2012
Manganese ore production (kt)	2,056	1,808	3,526	3,490	3,625
Manganese alloy production (kt)	233	180	377	374	404
Manganese ore sales (kt) ^(a)	1,982	1,634	3,480	3,491	3,451
External customers	1,478	1,240	2,668	2,771	2,717
Metalloys	504	394	812	720	734
Manganese alloy sales (kt) ^(a)	224	175	400	385	459
Realised manganese ore sales price (US\$/t) ^(a)	117	139	131	154	139
Realised manganese alloy sales price (US\$/t) ^(a)	911	943	990	1,044	1,190
Ore operating unit cost (US\$/t produced)	79	83	82	121	139
Alloy operating unit cost (US\$/t produced) ^(b)	901	1,228	1,175	1,083	1,334

(a) Volumes and prices do not include any third party trading that may be undertaken independently of the equity production. Realised sales price is calculated as sales revenue divided by sales volume.

(b) Includes the cost of the manganese ore acquired by Metalloys from Hotazel Mines at market prices.

Table 7.27: South Africa Manganese financial summary

100 per cent terms US\$M	6 months ended December		12 months ended June		
	H1 FY2015	H1 FY2014	FY2014	FY2013	FY2012
Sales revenue ^(a)	386	350	788	856	932
Manganese Ore	232	227	456	536	478
Manganese Alloy	204	165	396	402	546
Intra-segment elimination	(50)	(42)	(64)	(82)	(92)
Underlying EBITDA	63	21	120	111	(18)
Manganese Ore	69	77	167	114	(25)
Manganese Alloy	(6)	(56)	(47)	(3)	7
Underlying EBIT	26	(9)	48	58	(51)
Manganese Ore	43	58	118	78	(61)
Manganese Alloy	(17)	(67)	(70)	(20)	10
Net operating assets	802	813	790	845	786
Manganese Ore	454	551	557	526	518
Manganese Alloy	348	262	233	319	268
Minor and maintenance capital expenditure	33	21	11	58	63
Major projects capital expenditure	4	11	59	46	68
Exploration expenditure	1	-	-	-	-
Exploration expensed	1	-	-	-	-

(a) As per accounting policies, revenues referring to sales from Hotazel Mines to Metalloys are eliminated as part of the consolidation.

During FY2014, raw materials and consumables, energy (including fuel) and labour-related costs comprised 42 per cent, 17 per cent and 31 per cent of South Africa Manganese's operating cash costs respectively. The remaining cash costs included freight, secondary taxes and royalties, among other things.

(i) **Cerro Matoso**

(1) **Overview**

South32's Cerro Matoso open-cut mine is one of the largest nickel lateritic operations in the world, and the smelter produces high-purity, low-carbon ferronickel granules. Cerro Matoso is operated by South32 and its FY2014 production was 44 kt of nickel in ferronickel form. Cerro Matoso has a reserve life of 15 years.

The location of Cerro Matoso's operations is shown below:

Diagram 7.11: Location of Cerro Matoso's operations



An overview of Cerro Matoso is provided below:

Table 7.28: Cerro Matoso overview

Location	Cerro Matoso is located 25 km southwest of Montelibano, Córdoba, in northern Colombia.
Ownership	Cerro Matoso is 99.94 per cent owned by South32 and 0.02 per cent owned by its current and former employees. The balance of the shares are currently held in a reserve account following a recent buy-back.
Operatorship	Operated by South32.
Workforce	Cerro Matoso had on average approximately 2,450 FTE employees and contractors in FY2014. The current labour collective agreement with the union is valid until 31 December 2015. South32 intends to engage with the relevant employees on the renewal or replacement of this agreement.
History	Cerro Matoso commenced mining in 1980 under the ownership of Billiton Plc and Instituto de Fomento Industrial, a Colombian Government company. The ferronickel smelter was commissioned in 1982 with an ore processing capacity of approximately 1.4 Mdmmt per annum (100 per cent basis) and has since undergone an expansion that was completed in 2001, which doubled the smelter's ore processing capacity to 2.8 Mdmmt per annum (100 per cent basis). Significant maintenance was undertaken in 2011 to rebuild Furnace 01. In 1989, Billiton Plc increased its ownership in Cerro Matoso to 53 per cent. Following the merger between Billiton Plc and BHP Limited, further increases in BHP Billiton's ownership of Cerro Matoso took place in 2007 and 2014, with the company's interest rising to 99.94 per cent.

Title, leases or options	<p>Cerro Matoso's mining licence 051-96M covers an area of 52,850 ha. This licence is valid until 2029 (686 ha of mining area is in the exploitation stage, with the balance currently in the exploration stage until August 2020, after which the economically exploitable areas will pass to the exploitation stage), and includes a conditional extension to 2044 if certain ore processing capacity expansions and exploration commitments are met (including obtaining the associated environmental approvals). Under the terms pursuant to which the mining licence is granted, a 12 per cent royalty is payable, together with an additional one per cent contribution that applied from October 2012. The extension of the contract term to 2044 is conditional on Cerro Matoso increasing processing capacity by 50 per cent by 2022. Section 2.1(f) sets out certain disputes that are currently on foot in respect of the mining licence held by Cerro Matoso and also in respect of the privatisation of Cerro Matoso.</p> <p>South32 may, in some circumstances, be able to rely (in relation to 52.37 per cent of its indirect interest in Cerro Matoso) on an investment protection agreement (Cerro Matoso IPA) in order to mitigate the effect of adverse claims impacting on its mining licence. The Cerro Matoso IPA was entered into between (i) the Republic of Colombia, and (ii) BHP Billiton (BVI) Limited and Conicol (BVI) Limited (together the BHP Billiton IPA Parties) on 13 November 1996. It includes provisions to protect the interests held in Contract 051-96M by CMSA, and the BHP Billiton IPA Parties' interest in CMSA, against breaches or violation of law (including rules of international law applicable in Colombia) by the Republic of Colombia. The protections are limited to 52.37 per cent of South32's indirect interest as the other 47.62 per cent indirect interest was acquired after the execution of the Cerro Matoso IPA. Under the Cerro Matoso IPA, if a dispute resolution procedure cannot be agreed between the parties, disputes are subject to international arbitration. The Cerro Matoso IPA remains in force during the life of Contract 051-096, including any amendment to Contract 051-96M.</p>
Resources and reserves	<p>As at 30 June 2014, in 100 per cent terms, Cerro Matoso's Measured, Indicated and Inferred Mineral Resources comprised 289 Mt of laterite ores (at 0.9 per cent contained nickel), 51 Mt of stockpile material (at 1.1 per cent contained nickel) and 17 Mt of slag stockpile in metal nickel recovery process (at 0.2 per cent contained nickel). Cerro Matoso's Proved and Probable Ore Reserves were 24 Mt of laterite ores (at 1.1 per cent contained nickel) and 24 Mt of stockpile material (at 1.3 per cent contained nickel).^(a)</p>
Mining and processing	<p>Cerro Matoso is a truck and shovel open-cut operation. Ore mined is blended with ore from stockpiles before it is passed through a two-stage crushing sequence.</p> <p>After crushing, the ore is mixed and homogenised before it is partially dried in two rotary driers. An upgrading process is then undertaken whereby lower nickel grade is removed. After the upgrading process, the dried ore is then blended with a reductant agent (locally bought coal) and calcined in two rotary kilns.</p> <p>Calcined ore is then transferred to two 75 MW electric furnaces where ferronickel is tapped at around 1,460° C. The crude metal is transported to the refinery where impurities are removed. The refined metal is granulated and packed.</p> <p>Cerro Matoso has a water management system which allows it to recycle 95 per cent of the water used in operations. The remaining 5 per cent water loss (due mainly to evaporation) is restored with fresh water from rainfall in operational areas and from the Uré River, in accordance with an environmental permit from the environmental authority.</p>
Logistics and marketing	<p>Ferronickel is transported approximately 260 km by road to the Port of Cartagena, where it is shipped to customers, who are mainly located in Asia, North America and Europe.</p>
Overview of significant contracts	<p>Cerro Matoso's electricity is sourced under contracts that are in place until 2018.</p> <p>The supply of gas to Cerro Matoso is currently contracted until 2021. This contract covers the volume of gas, but the price of gas is set by the Colombian Government each year. Gas is transported to the operation through Cerro Matoso's gas pipeline, which covers a distance of approximately 80 km.</p>
Projects and developments	<p>The Mine Expansion Project is currently under consideration by Cerro Matoso. This project is designed to mitigate Cerro Matoso's nickel grade decline by increasing the nickel grade of crusher feed during the period FY2018 to FY2022. The progress of this project remains subject to favourable market conditions and Cerro Matoso obtaining the requisite project approvals (including environmental approvals) and consultation with nearby communities. Any delay in obtaining these approvals may result in a delay to the date that the project is expected to commence and if the approvals are not obtained the project will not proceed. There are options available to South32 to extend operations beyond 2029, subject to regulatory approval and market conditions.</p>

(a) Mineral Resources and Ore Reserves above are based on the information in Section 7.2.

(2) Summary historical financial and operating information

A summary of operating metrics and financial information for the integrated operations is set out below:

Table 7.29: Cerro Matoso operating metrics

South32's share	6 months ended December		12 months ended June		
	H1 FY2015	H1 FY2014	FY2014	FY2013	FY2012
Ore mined (kwmt)	3,339	4,386	8,490	9,015	9,065
Ore processed (kdmt)	1,335	1,347	2,493	2,649	2,541
Ore grade processed (per cent, Ni)	1.8	2.0	1.9	2.0	2.1
Payable nickel production (kt)	21	24	44	51	49
Payable nickel sales (kt)	21	25	45	52	48
Realised nickel sales price (US\$/t) ^(a)	16,190	12,600	13,222	15,442	18,250
Operating unit cost (US\$/t processed)	170	202	204	215	181

(a) Inclusive of by-products. Realised sales price is calculated as sales revenue divided by sales volume.

Table 7.30: Cerro Matoso financial summary

South32's share US\$M	6 months ended December		12 months ended June		
	H1 FY2015	H1 FY2014	FY2014	FY2013	FY2012
Sales revenue	340	315	595	803	876
Underlying EBITDA	113	43	87	234	417
Underlying EBIT	86	1	(1)	155	337
Net operating assets	854	937	860	990	1,003
Minor and maintenance capital expenditure	18	34	36	43	43
Major projects capital expenditure	–	1	20	7	62
Exploration expenditure	5	4	8	10	13
Exploration expensed	1	2	2	1	2

During FY2014, raw materials and consumables, energy (including fuel) and labour-related costs comprised 23 per cent, 33 per cent and 35 per cent of Cerro Matoso's operating cash costs respectively. The remaining cash costs included freight, secondary taxes and royalties, among other things.

(j) Cannington**(1) Overview**

Cannington is 100 per cent owned and operated by South32. The Cannington mine is located in northwest Queensland, Australia. Operations include an underground mine and concentrator located approximately 200 km southeast of Mount Isa, a rail loading facility located in Cloncurry and a port located at Townsville.

The underground mine feeds the concentrator that extracts silver, lead and zinc concentrates from sulphide ore before the concentrate is trucked to Cloncurry and then railed to Townsville.

Since commissioning in 1997, ore production has increased from 1.5 Mtpa at commissioning to 3.2 Mtpa in FY2014. In FY2014, Cannington produced concentrates containing approximately 25.2 Moz of silver, 187 kt of lead and 58 kt of zinc. Cannington has a reserve life of nine years, based on the current mine plan.

The location of Cannington's operations is shown below:

Diagram 7.12: Location of Cannington's operations

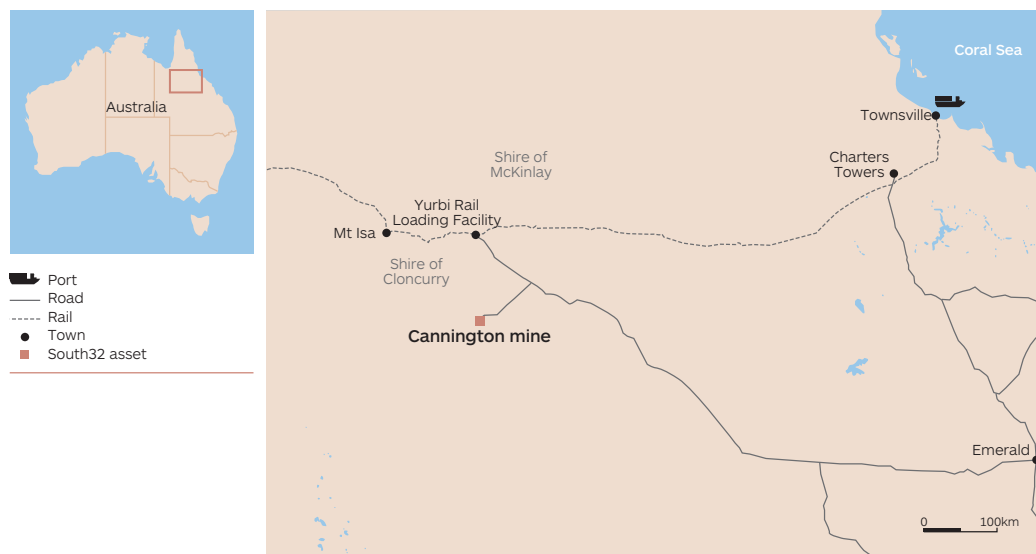

An overview of Cannington is provided below:

Table 7.31: Cannington overview

Location	<p>The Cannington mine and concentrator are located approximately 200 km southeast of Mount Isa, Queensland, Australia.</p> <p>The Yurbi Rail Load-out facility is located at Cloncurry, approximately 180 km by road from the Cannington mine.</p> <p>Cannington port facility is located at Townsville.</p>
Ownership	100 per cent owned by South32.
Operatorship	Operated by South32.
Workforce	Cannington had on average approximately 1,150 FTE employees and contractors in FY2014.
History	The Cannington silver, lead and zinc mine was discovered by BHP Minerals in 1990. Development of an underground mine commenced in 1996. Construction of mine infrastructure and processing facilities was completed in 1997 and the mine commissioned in the same year.
Title, leases or options	<p>Cannington holds mining lease ML90059, expiring in 2029, as well as borefield lease ML90060, expiring in 2030 and the Yurbi Rail Load-out lease ML90077, expiring in 2030. These leases cover an area of 8,651 ha.</p> <p>Cannington also maintains Permitted Use Lease E 50309781 and Water Management Lease C 50309781 at the Port of Townsville for operational purposes. These are supported by three licences for berth access.</p>
Resources and reserves	<p>At 30 June 2014, in 100 per cent terms, Cannington's Measured, Indicated and Inferred Mineral Resource comprised an underground component of 60 Mt at 197 g/t silver, 5.57 per cent lead and 3.50 per cent zinc.</p> <p>Open-cut Measured, Indicated and Inferred Resources as at the same date were 16 Mt at 70 g/t silver, 3.01 per cent lead and 2.06 per cent zinc.</p> <p>Cannington's Proved and Probable Ore Reserve of underground sulphide were 21 Mt at 239 g/t silver, 6.35 per cent lead and 3.93 per cent zinc.^(a)</p>

Mining and processing	<p>Cannington produces a silver-rich lead concentrate and a zinc concentrate through a 3.2 Mtpa capacity mill.</p> <p>Ore is mined by using a sub-level long hole open stoping underground mining method. Ore is transported to the ROM stockpile through a hoist, with additional production being trucked to the surface.</p> <p>For mining operations to continue, the void created by the extraction of ore is filled using a paste, which is a combination of cement and tailings.</p> <p>Six core processing steps are used to produce the silver, lead and zinc concentrates: crushing, grinding, floatation, leaching, dewatering and paste fill preparation.</p> <p>Cannington is supported at the present production rates by the installed infrastructure on site at Yurbi and at the Townsville port facility.</p> <p>Water is supplied through a series of bores, which draw water from the Great Artesian Basin. EDL operates an on-site power station using a series of gas turbines, supplemented with diesel generation.</p>
Logistics and marketing	<p>Concentrate produced at Cannington is transferred by road trains to the Yurbi Rail Load-out facility, located approximately 180 km from the mine. Concentrate is transferred to train wagons at the loading facility and transported by rail to the Port of Townsville, approximately 800 km to the east.</p> <p>Cannington's rail transport provider uses fabricated fibreglass lids, securely locked onto each wagon, to prevent any dust emissions during the journey to Townsville, which takes approximately 24 hours.</p> <p>Concentrate is exported to markets in South Korea, Japan, Europe and Canada via Cannington's port facility at the Port of Townsville.</p> <p>Cannington's largest customer accounts for close to 35 per cent of Cannington's revenue.</p>
Overview of significant contracts	<p>Cannington has gas supply arrangements contracted until 31 December 2015. Cannington will need to negotiate a new contract for gas supply after this date, the terms of which may be less favourable than those under existing contractual arrangements.</p>
Projects and developments	<p>As outlined in Section 5.4(e), a number of studies have been completed into the optimal way to extract value from the residual resource at Cannington. South32 management will carefully assess alternatives for effectively exploiting this significant resource.</p> <p>Any proposed life extension of Cannington would be subject to favourable market conditions, Cannington obtaining the requisite regulatory approvals and the project meeting South32's financial criteria.</p>

(a) Mineral Resources and Ore Reserves above are based on the information in Section 7.2.

(2) Summary historical financial and operating information

A summary of operating metrics and financial information for the Cannington operations is set out below:

Table 7.32: Cannington operating metrics

South32's share	6 months ended December		12 months ended June		
	H1 FY2015	H1 FY2014	FY2014	FY2013	FY2012
Ore mined (kt)	1,748	1,867	3,446	3,146	3,233
Ore processed (kt)	1,669	1,602	3,202	3,145	3,337
Ore grade processed (g/t, Ag)	273	293	296	360	372
Ore grade processed (% , Pb)	7.0%	7.0%	7.1%	7.9%	8.3%
Ore grade processed (% , Zn)	3.5%	3.2%	3.0%	3.0%	2.8%
Payable Silver production (koz)	12,235	12,667	25,161	31,062	34,208
Payable Lead production (kt)	99	94	187	213	239
Payable Zinc production (kt)	37	32	58	56	55
Payable Silver sales (koz)	12,715	14,392	26,160	30,258	33,259
Payable Lead sales (kt)	100	104	189	219	237
Payable Zinc sales (kt)	33	36	62	57	55
Realised Silver sales price (US\$/oz) ^(a)	17	20	20	27	31
Realised Lead sales price (US\$/t) ^(a)	1,950	2,413	2,344	2,030	1,879
Realised Zinc sales price (US\$/t) ^(a)	2,273	1,917	2,000	1,787	1,918
Operating unit cost (US\$/t ore processed)	182	208	193	227	209

(a) Realised sales price is calculated as sales revenue divided by sales volume.

Table 7.33: Cannington financial summary

South32's share US\$M	6 months ended December		12 months ended June		
	H1 FY2015	H1 FY2014	FY2014	FY2013	FY2012
Sales revenue ^(a)	486	605	1,079	1,365	1,590
Underlying EBITDA	183	272	460	651	893
Underlying EBIT	154	251	413	611	840
Net operating assets	192	244	234	206	194
Minor and maintenance capital expenditure	14	30	60	39	62
Major projects capital expenditure	–	–	–	–	11
Exploration expenditure	3	3	5	8	14
Exploration expensed	3	3	5	8	14

(a) Includes silver, lead and zinc sales revenue.

During FY2014, raw materials and consumables, energy (including fuel) and labour-related costs comprised 13 per cent, seven per cent and 62 per cent of Cannington's operating cash costs respectively. The remaining cash costs included freight, secondary taxes and royalties, among other things.

7.2 SUMMARY OF MINERAL RESOURCES AND ORE RESERVES INFORMATION

(a) Statements of Mineral Resources and Ore Reserves

The statements of Mineral Resources and Ore Reserves (including Coal Resources and Coal Reserves) presented in Section 7.2 have been produced in accordance with the ASX Listing Rules Chapter 5, the Recommendations of the European Securities and Markets Authority on the consistent implementation of Commission Regulation (EC) No. 809/2004 implementing the Prospectus Directive and the JORC Code. Mineral Resources and Ore Reserves have been previously reported in the ASX release titled, 2014 BHP Billiton Annual Report – 25 September 2014 available at www.bhpbilliton.com or the ASX website at www.asx.com.au. Commodity prices and exchange rates used to estimate the economic viability of reserves are based on asset-defined or South32 long-term forecasts. The Ore Reserves tabulated are held within existing, permitted mining tenements. The South32 Businesses mineral leases are of sufficient duration (or convey a legal right to renew for sufficient duration) to enable all reserves on the leased properties to be mined in accordance with current production schedules. South32's Ore Reserves may include areas where some additional approvals remain outstanding, but where, based on the technical investigations South32 carries out as part of its planning process and South32's knowledge and experience of the approvals process, South32 expects that such approvals will be obtained as part of the normal course of business and within the time frames required by the current schedules.

The information in this document relating to Mineral Resources and Ore Reserves is based on information compiled by Competent Persons (as defined in the JORC Code). All Competent Persons have, at the time of reporting, sufficient experience relevant to the style of mineralisation and type of deposit under consideration and to the activity they are undertaking to qualify as a Competent Person as defined by the JORC Code. At the date their report was issued, each Competent Person listed in Section 7.2 was a full-time employee of BHP Billiton, with the exception of R Aglinskis and J P de Melo Franco (MAusIMM, both were employed by Mineração Rio do Norte) and M Bryant (MAusIMM, employed by Bryant Mining Pty Ltd).

Each Competent Person has given, and has not withdrawn their written consent to the:

- inclusion in this document of the Mineral Resources and Ore Reserves information, which they have provided in relation to their respective deposits as set out in Section 7.2(b);
- references to their name included herein in the form and context in which they appear and has authorised the inclusion of such information in this document.

Each of the Competent Persons accepts responsibility for the relevant Mineral Resources and Ore Reserves information they have provided as set out in Section 7.2(b). To the best of the knowledge of each of the Competent Persons (each of whom has taken all reasonable care to ensure that such is the case), the relevant Mineral Resources and Ore Reserves information they have provided and contained in this document is in accordance with the facts and contains no omissions likely to affect the import of such information.

All of the Mineral Resources and Ore Reserves figures presented are reported in 100 per cent terms, represent estimates at 30 June 2014 (unless otherwise stated) and do not take depletion of Mineral Resources and Ore Reserves since that date into account (note that the Independent Competent Persons' Reports in Annexure 6 contain estimates at 31 December 2014). All tonnes are reported as dry metric tonnes (unless otherwise stated). All tonnes and grade information have been rounded; hence, small differences may be present in the totals. All of the Mineral Resources information is inclusive of Mineral Resources that have been converted to Ore Reserves (i.e. Mineral Resources are not additional to Ore Reserves).

South32 will apply governance arrangements and internal controls to verify the estimates and estimation process for Mineral Resources and Ore Reserves. These include:

- standard company procedures for public reporting aligned with current regulatory requirements;
- independent audits of new or materially changed estimates;
- periodic audits of resources and reserves estimates for each asset;
- annual reconciliation performance metrics to validate reserves estimates for operating mines.

Mineral Resources and Ore Reserves are presented in the accompanying tables.

With the exception of Cannington, the Mineral Resources and Ore Reserves figures quoted as at 31 December 2014 in the Independent Competent Persons' Reports in Annexure 6, are consistent with the figures quoted in Section 7.2 as at 30 June 2014. The numbers as at 31 December 2014 are the 30 June 2014 figures which have been depleted for actual and forecast mine production. They are not a re-estimation of the 30 June 2014 Mineral Resources and Ore Reserves estimate and do not include any additional geological, mining, processing or other information.

A net 5 Mt increase in the 31 December 2014 Cannington resource is reflective of a reassignment of tonnes excluded in the 30 June 2014 statement. The Cannington reported resource was understated by 7 Mt of Indicated Resource as at 30 June 2014, and 2 Mt of Measured Resource was produced in the half year ended 31 December 2014, resulting in a net gain of 5 Mt.

(b) Competent Persons

(1) Worsley Alumina

Mineral Resources

J Binoir, MSc (Exploration Geology), BSc (Hons), MAusIMM is the Senior Resource Geologist at Worsley Alumina and has over 16 years' mining industry experience, specialising in geological modelling, geostatistical analysis and resource estimation.

J Engelbrecht, BSc (Geology and Geography), BSc (Hons), MAusIMM, is the Superintendent Resource Geology at Worsley Alumina and has over 16 years' experience in various commodities, including mineral sands, bauxite, base metals and gold with specialisation in exploration, open-cut and underground mining.

Ore Reserves

G Burnham, MSc (Mineral Exploration), BSc (Geology), MAusIMM is the Superintendent Mine Planning at Worsley Alumina and has over 14 years' mining industry experience, including mine, resource and project geology and medium and long-term planning.

(2) MRN Mine

Mineral Resources

R Aglinskis, BSc (Geology), MAusIMM is the Manager Geology employed by Mineração Rio do Norte and has over 14 years of mining industry experience, including geological data management, pre-feasibility and technical studies, mine geology, short to long-term planning, exploration drilling, resource and reserve modelling and tenure management.

Ore Reserves

J P de Melo Franco, BSc (Mining), MAusIMM is an independent mining consultant employed by Mineração Rio do Norte with over 33 years of mining industry experience, specialising in geology, planning, production, beneficiation and construction.

(3) South Africa Energy Coal

Mineral Resources

Khutala

G Gemmell, BSc (Hons), SACNASP is Chief Geologist with BHP Billiton and has over 21 years' experience in the mining industry, with significant experience in exploration, geological modelling, resource estimation and reporting and grade control.

Wolvekrans and Middelburg

L Visser, BSc, SACNASP is Superintendent Geologist with BHP Billiton and has over 17 years' experience in the mining industry, with significant experience in exploration, geological modelling, resource estimation and reporting, grade control and reconciliation.

Klipspruit

P Maseko, BSc (Hons), Dip in Datamatics, GSSA, SACNASP is Superintendent Geologist with BHP Billiton and has over 29 years' experience in the coal industry, with significant experience in exploration, geological modelling, resource estimation and reporting and reconciliation.

Leandra North, Naudesbank, Weltevreden and Leandra South

N Haniff, BSc (Hons Geology), MSc (Environ Geochem), SACNASP is Resource Geologist with BHP Billiton and has more than 18 years' experience in the mining industry, with experience in underground mapping, resource estimation and reporting and financial evaluation.

Khutala, Wolvekrans, Middelburg, Klipspruit, Leandra North, Naudesbank, Weltevreden and Leandra South

J H Marais, BSc (Hons), GSSA is Chief Geologist with BHP Billiton and has over 30 years' experience in the coal industry in both underground and open-cut operations, with significant experience in exploration, geological modelling, resource estimation and reporting, grade control and reconciliation.

Ore Reserves

Khutala, Wolvekrans, Middelburg and Klipspruit

I Thomson, BEng (Mining), MBA, SAImm is Manager, Long-term Planning with BHP Billiton and has over 27 years' experience in the mining industry, with significant experience in managing open-cut and underground mine operation, estimation and reporting of Ore Reserves, outbound logistics planning, scheduling, administration and operations and business improvement through six sigma.

(4) Illawarra Metallurgical Coal

Mineral Resources

Appin, West Cliff, Dendrobium and Cordeaux

H Kaag, BSc (Hons), MAusIMM is a Principal Geologist with BHP Billiton and has over 25 years' experience in the coal industry both in operations and consulting, specialising in exploration, geological modelling, resource estimation and reporting, grade control and reconciliation.

Ore Reserves

Appin, West Cliff and Dendrobium

M Rose, BEng (Hons), MAusIMM is a Principal Mining Engineer with BHP Billiton and has 14 years' experience in medium and long-term mine planning, scheduling, financial modelling and valuation, design and scoping of ventilation and gas monitoring systems, reconciliation and Ore Reserves reporting.

(5) GEMCO

Mineral Resources

D Hope, BSc (Geology), MAusIMM is the Manager Geological Services at GEMCO and has over 22 years of mining industry experience, specialising in grade control, exploration, project, mine and resource geology, geological data management, resource modelling and tenure management.

Ore Reserves

M Bryant, MAusIMM is a mining consultant employed by Bryant Mining Pty Ltd and has over 15 years of experience in the mining industry, including mine design and scheduling, planning system development, optimisation studies, costing and financial evaluations and reserves estimation.

(6) South Africa Manganese

Mineral Resources

Wessels and Mamatwan

E P Ferreira, MSc (Geology), BSc (Hons), SACNASP is the Superintendent Integrated Mine Planning Geology at Hotazel Mines with over 32 years of mining, research and lecturing experience, specialising in geological mapping, exploration planning and management, geological data management, budget and capital projects control and strategic planning.

C Nengovhela, MSc (Geology), BSc (Hons), SACNASP is the Sub Function Lead Resource Geology and Exploration at Hotazel Mines with over 10 years of mining, research and consulting experience in various commodities, with specialisation in exploration, geological modelling and resource estimation, mine design, resource range analysis and reconciliation.

Ore Reserves

Wessels and Mamatwan

D Mathebula, BSc (Hons), SAImm is the Manager Production Planning at Hotazel Mines with over 12 years of experience in underground and open-cut coal and manganese mining, specialising in short to long-term planning, mine scheduling, reserves estimation and reconciliation.

(7) Cerro Matoso

Mineral Resources

I Espitia, BSc (Hons), MAusIMM, is the Resource Model Superintendent at Cerro Matoso S.A. and has over eight years of experience in the mining industry including minerals exploration, field mapping, geological data management, geological modelling and resource estimation.

Ore Reserves

F Fuentes, MAusIMM is the Long-Term Mine Planning Superintendent at Cerro Matoso S.A. and has over 17 years of experience in the mining industry, specialising in reserves estimation, open-cut mine planning, optimisation and design, mine scheduling, mining projects studies and strategic planning.

(8) Cannington

Mineral Resources

B Coutts, BSc (Hons), MAusIMM, SEG (Fellow) is the Manager Planning at Cannington mine and has over 24 years of experience in the mining industry, including exploration and mine geology, short to long-term planning, production, engineering and infrastructure, logistics and planning and resource planning.

Ore Reserves

M Dowdell, BEng (Mining Engineering), MAusIMM is the Senior Mine Planning Engineer at Cannington mine and has over 13 years multi-commodity mining industry experience, mainly in underground mines drill and blast designs, development and short to long-term planning.

ALUMINIUM

Table 7.34: Aluminium Mineral Resources

As at 30 June 2014 (reported in 100 per cent terms)

Commodity Deposit ^(a)	Ore Type	Measured Resources			Indicated Resources			Inferred Resources			Total Resources			South32's Interest %
		Mt	% A.Al ₂ O ₃	% R.SiO ₂	Mt	% A.Al ₂ O ₃	% R.SiO ₂	Mt	% A.Al ₂ O ₃	% R.SiO ₂	Mt	% A.Al ₂ O ₃	% R.SiO ₂	
Bauxite Australia														
Worsley Alumina	Laterite	366	31.1	1.5	355	32.0	2.3	418	31.2	2.6	1,140	31.4	2.2	86
Brazil														
MRN Mine ^(b)	MRN Crude	172	–	–	43	–	–	525	–	–	740	–	–	14.8
	MRN Washed	128	50.0	4.0	32	50.5	4.2	367	50.2	4.2	527	50.2	4.2	

Table 7.35: Aluminium Ore Reserves

As at 30 June 2014 (reported in 100 per cent terms)

Commodity Deposit ^{(a),(c),(d),(e)}	Ore Type	Proved Ore Reserves			Probable Ore Reserves			Total Ore Reserves			Reserve Life (years)	South32's Interest %
		Mt	% A.Al ₂ O ₃	% R.SiO ₂	Mt	% A.Al ₂ O ₃	% R.SiO ₂	Mt	% A.Al ₂ O ₃	% R.SiO ₂		
Bauxite Australia												
Worsley Alumina	Laterite	274	31.0	1.6	22	30.2	1.7	295	31.0	1.6	17	86
Brazil												
MRN Mine ^{(f),(g)}	MRN Washed	79	49.3	4.6	19	49.8	4.8	98	49.4	4.6	6.1	14.8

(a) Cut-off grades for Mineral Resources and Ore Reserves – Worsley Alumina: variable ranging from 24–29.5 per cent A.Al₂O₃, ≤ 3 per cent R.SiO₂ and ≥ 1m thickness; MRN Washed ≥ 50 per cent TAl₂O₃, ≤ 10 per cent TSiO₂, ≥ 1m thickness and ≥ 30 per cent recovery on a weight per cent basis.

(b) MRN Mine – MRN Washed tonnes and grade represent expected product based on forecast beneficiated yield.

(c) Ore delivered to process plant.

(d) Approximate drill hole spacings used to classify the reserves were:

Deposit	Proved Ore Reserves	Probable Ore Reserves
Worsley Alumina	Maximum 80m	Maximum 160m
MRN Mine	A bauxite intersection grid of 200m, plus at least 10 samples reached by search ellipsoid. Mining and metallurgical characterisation (test pit/bulk sample), plus a reliable suite of chemical and size distribution data.	Those areas with a bauxite intersection grid spacing of less than 400m and/or a 400m spaced grid with a 200m offset fill in, plus a minimum of seven samples reached by search ellipsoid, plus a reliable suite of chemical and size distribution data.

(e) Metallurgical recoveries for the operations were:

Deposit	Estimated Metallurgical Recovery of A.Al ₂ O ₃
Worsley Alumina (Worsley Alumina refinery)	91%
MRN Mine (Alumar refinery)	92%

(f) MRN Mine – MRN Washed tonnes and grade represent expected product based on forecast beneficiated yield.

(g) MRN Mine – The MRN reserves are located on mining leases that provide MRN the right to mine. Current mining areas have environmental approval to operate. As further operational licences are obtained, Mineral Resources will be converted to Ore Reserves.

COAL

Table 7.36: Coal Resources

As at 30 June 2014 (reported in 100 per cent terms)																			
Commodity Deposit ^{(a),(b)}	Mining Method	Coal Type	Measured Coal Resources				Indicated Coal Resources				Inferred Coal Resources				Total Coal Resources				South32's Interest %
			Mt	% Ash	% VM	% S	Mt	% Ash	% VM	% S	Mt	% Ash	% VM	% S	Mt	% Ash	% VM	% S	
Illawarra Metallurgical Coal																			
Appin	UG	Met/Th	157	11.2	23.8	0.37	256	12.6	24.2	0.36	289	13.5	23.8	0.36	702	12.7	24.0	0.36	100
West Cliff	UG	Met/Th	21	12.3	21.3	0.36	21	11.9	20.7	0.34	68	13.9	19.9	0.33	110	13.3	20.3	0.34	100
Dendrobium	UG	Met/Th	86	29.8	23.7	0.59	91	29.8	23.1	0.58	118	29.4	22.8	0.58	295	29.6	23.2	0.58	100
Cordeaux	UG	Met/Th	5.2	28.7	21.1	0.58	109	29.1	21.5	0.56	85	29.0	22.1	0.57	199	29.0	21.8	0.57	100

(a) The coal quality for Illawarra Metallurgical Coal is for in situ quality on an air-dried basis. Tonnages are on an in situ moisture basis.

(b) The cut-off criteria used were: Illawarra Metallurgical Coal no seam thickness cut-off because the minimum thickness is economic.

Table 7.37: Coal Reserves

As at 30 June 2014 (reported in 100 per cent terms)																			
Commodity Deposit ^{(a),(b),(c),(d),(e)}	Mining Method	Coal Type	Proved Coal Reserves	Probable Coal Reserves	Total Coal Reserves	Proved Marketable Coal Reserves				Probable Marketable Coal Reserves				Total Marketable Coal Reserves				Reserve Life (years)	South32's Interest %
			Mt	Mt	Mt	Mt	% Ash	% VM	% S	Mt	% Ash	% VM	% S	Mt	% Ash	% VM	% S		
Illawarra Metallurgical Coal																			
Appin	UG	Met/Th	24	133	157	20	8.9	23.5	0.37	112	8.9	24.9	0.36	132	8.9	24.7	0.36	25	100
West Cliff	UG	Met/Th	5.4	0.4	5.8	3.8	8.9	20.6	0.36	0.3	8.9	20.1	0.36	4.1	8.9	20.6	0.36	2.0	100
Dendrobium	UG	Met/Th	21	24	45	-	-	-	-	-	-	-	-	-	-	-	-	8.9	100
	UG	Met	-	-	-	8.6	9.7	23.8	0.59	9.9	9.7	24.2	0.59	18	9.7	24.0	0.59		
	UG	Th	-	-	-	5.2	23.0	-	-	6.3	23.0	-	-	12	23.0	-	-		

(a) Only geophysically logged, fully analysed cored holes with greater than 95 per cent recovery were used to classify the reserves. Drill hole spacings vary between seams and geological domains and were determined in conjunction with geostatistical analyses where applicable. The range of maximum spacings was:

Deposit	Proved Coal Reserves	Probable Coal Reserves
Appin	700m	1,500m
West Cliff	700m	1,500m
Dendrobium	700m	1,500m

(b) Product recoveries for the operations were:

Deposit	Product Recovery
Appin	84%
West Cliff	71%
Dendrobium	67%

(c) Total Coal Reserves are at the moisture content when mined (6 per cent Appin, West Cliff; 7 per cent Dendrobium). Total Marketable Coal Reserves (tonnes) are the tonnage of coal available, at moisture content (9 per cent Appin, and West Cliff; 13.5 per cent Dendrobium Met; 7 per cent Dendrobium Th) and air-dried quality, for sale after the beneficiation of the Total Coal Reserves. Note that where the coal will not be beneficiated, the tonnes of Total Coal Reserves are the tonnes of Total Marketable Coal Reserves, with moisture adjustment where applicable.

(d) The cut-off criteria applied were: Appin, West Cliff, Dendrobium \geq 1.8m seam thickness.

(e) Coal delivered to wash plant.

Table 7.38: Coal Resources

As at 30 June 2014 (reported in 100 per cent terms)

Commodity Deposit ^{(a),(b)}	Mining Method	Coal Type	Measured Coal Resources					Indicated Coal Resources					Inferred Coal Resources					Total Coal Resources					South32's Interest %	
			Mt	% Ash	% VM	% S	kcal/kg CV	Mt	% Ash	% VM	% S	kcal/kg CV	Mt	% Ash	% VM	% S	kcal/kg CV	Mt	% Ash	% VM	% S	kcal/kg CV		
South Africa																								
Khutala	OC	Th	1,143	31.5	22.3	1.16	4,790	-	-	-	-	-	-	-	-	-	-	-	1,143	31.5	22.3	1.16	4,790	90
	UG	Th	188	33.7	20.5	0.88	4,480	-	-	-	-	-	-	-	-	-	-	-	188	33.7	20.5	0.88	4,480	
Klipspruit	OC	Th	138	27.6	22.4	1.23	5,220	-	-	-	-	-	1.1	29.8	21.5	1.28	4,950	139	27.6	22.4	1.23	5,220	90	
Wolvekrans	OC	Th	496	25.9	23.2	1.16	5,600	18	30.0	22.7	1.02	5,100	118	30.2	23.1	1.06	5,100	632	26.8	23.2	1.14	5,490	90	
Middelburg	OC	Th	211	28.0	21.7	1.04	5,410	-	-	-	-	-	7.3	24.7	22.1	0.88	5,600	218	27.9	21.7	1.04	5,420	90	
Projects																								
Leandra North	UG	Th	210	27.7	23.1	1.30	4,990	194	27.3	23.4	1.24	5,030	103	27.0	23.5	1.23	5,060	507	27.4	23.3	1.26	5,020	90	
Naudesbank	OC & UG	Th	103	25.4	25.4	1.09	5,550	132	24.9	25.5	1.06	5,610	54	25.3	25.2	1.08	5,580	289	25.2	25.4	1.08	5,580	90	
Weltevreden	OC & UG	Th	192	29.2	22.1	1.30	5,150	212	31.1	21.7	1.14	4,970	143	30.6	21.9	1.18	5,050	547	30.3	21.9	1.21	5,050	90	
South Africa Miscellaneous																								
Leandra South	UG	Th	10	28.1	20.8	0.93	4,700	132	27.1	22.0	1.02	4,910	938	26.0	22.4	1.00	5,030	1,080	26.2	22.3	1.00	5,010	90	
T-Project ^(c)	UG	Th	-	-	-	-	-	-	-	-	-	-	183	32.2	20.3	0.86	4,500	183	32.2	20.3	0.86	4,500	90	
Davel	UG	Th	-	-	-	-	-	-	-	-	-	-	244	23.9	26.4	1.52	5,700	244	23.9	26.4	1.52	5,700	90	

(a) Tonnages are reported as in situ, except for South Africa, Projects and South Africa Miscellaneous, where tonnages are reported on an air-dried basis. Qualities are reported on an air-dried in situ basis.

(b) Cut-off criteria:

Deposit	Coal Resources	Coal Reserves
Khutala	≥ 1.0m seam thickness for OC, ≥ 2.5m seam thickness for UG, ≤ 45% ash, ≥ 24% dry ash-free VM	≥ 1.0m seam thickness for OC, ≥ 3.6m seam thickness for UG
Klipspruit	≥ 1.0m seam thickness, ≤ 45% ash, ≥ 24% dry ash-free VM	≥ 1.0m seam thickness, varying ≥ 3,580 kcal/kg to ≥ 4,300 kcal/kg, ≤ 45% ash
Wolvekrans	≥ 1.0m seam thickness, ≤ 45% ash, ≥ 17.9% VM	≥ 1.0m seam thickness, ≥ 2,870 kcal/kg CV, ≤ 45% ash, ≥ 17.9% VM
Middelburg	≥ 1.0m seam thickness, ≤ 45% ash, ≥ 17.9% VM	≥ 1.0m seam thickness, ≥ 2,870 kcal/kg CV, ≤ 45% ash, ≥ 17.9% VM
Leandra North	≥ 1.8m seam thickness	-

Deposit	Coal Resources	Coal Reserves
Naudesbank	varying ≥ 0.5m to 0.8m seam thickness, ≤ 45% ash, ≥ 22% dry ash-free VM	-
Weltevreden	≥ 0.8m seam thickness, ≤ 45% ash	-
Leandra South	≥ 1.8m seam thickness	-
T-Project	≥ 1.8m seam thickness, ≥ 18% VM	-
Davel	≥ 1.2m seam thickness, ≥ 18% VM	-

(c) T-Project – Divestment is in progress.

COAL

Table 7.39: Coal Reserves

As at 30 June 2014 (reported in 100 per cent terms)

Commodity Deposit ^{(a),(b),(c)}	Mining Method	Coal Type	Proved Coal Reserves	Probable Coal Reserves	Total Coal Reserves	Proved Marketable Coal Reserves				Probable Marketable Coal Reserves				Total Marketable Coal Reserves				Reserve Life (years)	South32's Interest %			
			Mt	Mt	Mt	Mt	% Ash	% VM	% S	kcal/kg CV	Mt	% Ash	% VM	% S	kcal/kg CV	Mt	% Ash	% VM	% S	kcal/kg CV		
South Africa																						
Khutala	OC	Th	1.4	-	1.4	1.3	35.7	21.1	1.15	4,640	-	-	-	-	-	1.3	35.7	21.1	1.15	4,640	90	
	UG	Th	36	-	36	33	33.6	20.3	0.76	4,440	-	-	-	-	-	33	33.6	20.3	0.76	4,440	5.8	
Wolvekrans	OC	Th	389	17	406	273	21.8	23.4	0.47	6,010	12	22.5	23.7	0.45	5,950	285	21.8	23.4	0.46	6,010	21	90
Middelburg	OC	Th	97	-	97	80	23.2	23.0	0.47	5,890	-	-	-	-	-	80	23.2	23.0	0.47	5,890	23	90
Klipspruit	OC	Th	43	-	43	36	23.0	23.3	0.82	5,800	-	-	-	-	-	36	23.0	23.3	0.82	5,800	6.0	90

(a) Tonnages are reported on an air-dried basis. Qualities are reported on an air-dried in situ basis.

(b) Approximate drill hole spacings used to classify the reserves were:

Deposit	Proved Coal Reserves	Probable Coal Reserves
Khutala	>8 boreholes per 100 ha	4 to 8 boreholes per 100 ha
Wolvekrans	>8 boreholes per 100 ha	4 to 8 boreholes per 100 ha
Middelburg	>8 boreholes per 100 ha	4 to 8 boreholes per 100 ha
Klipspruit	>8 boreholes per 100 ha	4 to 8 boreholes per 100 ha

(c) Product recoveries for the operations were:

Deposit	Product Recovery
Khutala	92%
Wolvekrans	70%
Middelburg	82%
Klipspruit	84%

MANGANESE

Table 7.40: Manganese Mineral Resources

As at 30 June 2014 (reported in 100 per cent terms)

Commodity Deposit ^(a)	Ore Type	Measured Resources			Indicated Resources			Inferred Resources			Total Resources			South32's Interest %
		Mt	% Mn	% Yield	Mt	% Mn	% Yield	Mt	% Mn	% Yield	Mt	% Mn	% Yield	
Manganese Australia														
GEMCO ^(b)	Sands	-	-	-	13	20.8	-	2.3	20.0	-	15	20.7	-	60
	ROM	95	46.1	48	46	43.6	47	34	42.7	49	175	44.8	48	
		Mt	% Mn	% Fe	Mt	% Mn	% Fe	Mt	% Mn	% Fe	Mt	% Mn	% Fe	
South Africa^(c)														
Wessels	Lower Body-HG	5.8	47.7	12.0	13	48.0	12.2	-	-	-	19	47.9	12.2	44.4
	Lower Body-LG	9.4	42.1	13.4	20	41.8	13.3	-	-	-	29	41.9	13.3	
	Upper Body	-	-	-	92	41.4	18.3	-	-	-	92	41.4	18.3	
Total for Wessels		15	44.2	12.9	125	42.2	16.9	-	-	-	140	42.4	16.4	44.4
Mamatwan	M, C, N Zones	19	37.7	4.4	45	37.2	4.5	5.2	37.4	4.7	69	37.4	4.5	44.4
	Top Cut (balance I&O)	9.0	30.5	6.6	20	29.9	6.3	5.6	29.1	6.2	34	29.9	6.4	
	X Zone	2.4	38.0	4.6	4.6	37.0	4.8	0.3	36.2	5.0	7.3	37.3	4.8	
Total for Mamatwan		30	35.6	5.1	70	35.1	5.0	11	33.2	5.5	110	35.1	5.1	44.4

(a) Cut-off grades for Mineral Resources and Ore Reserves – GEMCO: ≥ 40 per cent Mn washed product and ≥ 1 m ore thickness for ROM, > 0 per cent Mn in situ for Sands; Wessels: ≥ 45 per cent Mn for Lower Body-HG, ≥ 37.5 per cent Mn for Lower Body-LG and Upper Body; Mamatwan: ≥ 35 per cent Mn for M, C, N and X Zones, ≥ 28 per cent Mn for Top Cut (balance I&O).

(b) GEMCO – Mineral Resource ROM tonnes are stated as in situ, manganese grades are given as per washed ore sample and should be read together with their respective tonnage yields. Mineral Resource Sands tonnes and manganese grades are reported as in situ. Ore Reserve tonnes are stated as ROM, manganese grades are reported as expected product and should be read together with their respective tonnage yields.

(c) Wessels and Mamatwan – Tonnes are stated as wet tonnes.

MANGANESE

Table 7.41: Manganese Ore Reserves

As at 30 June 2014 (reported in 100 per cent terms)

Commodity Deposit ^{(a),(d),(e),(f)}	Ore Type	Proved Ore Reserves			Probable Ore Reserves			Total Ore Reserves			Reserve Life (years)	South32's Interest %
		Mt	% Mn	% Yield	Mt	% Mn	% Yield	Mt	% Mn	% Yield		
Manganese Australia												
GEMCO ^(b)	ROM	78	45.0	58	16	42.6	57	94	44.6	58	11	60
South Africa^(c)												
Wessels	Lower Body-HG	1.2	48.0	12.2	7.2	47.6	12.3	8.4	47.7	12.3	46	44.4
	Lower Body-LG	2.2	41.3	11.9	13	41.8	13.2	15	41.7	13.0		
	Upper Body	-	-	-	46	41.4	18.2	46	41.4	18.2		
Total for Wessels		3	43.7	12.0	66	42.2	16.6	69	42.2	16.4		44.4
Mamatwan	M, C, N Zones	19	37.6	4.4	41	37.1	4.5	60	37.3	4.5	18	44.4
	X Zone	1.6	38.2	4.7	2.4	36.7	4.8	4.0	37.3	4.8		
Total for Mamatwan		21	37.7	4.4	43	37.1	4.5	64	37.3	4.5		44.4

(a) Cut-off grades for Mineral Resources and Ore Reserves as for Table 7.40.

(b) GEMCO – Ore Reserve tonnes are stated as ROM, manganese grades are reported as expected product and should be read together with their respective tonnage yields.

(c) Wessels and Mamatwan – Tonnes are stated as wet tonnes.

(d) Approximate drill hole spacings used to classify the reserves were:

Deposit	Proved Ore Reserves	Probable Ore Reserves
GEMCO	60m x 120m and 60m x 60m	120m x 120m
Wessels	Defined as rim ±30m wide around mined-out areas, supplemented by some economically viable remnant blocks within mined-out areas	Defined as all ground beyond 30m
Mamatwan	80m x 80m	160m x 160m

(e) Metallurgical recoveries for the operations were:

Deposit	Metallurgical Recovery
GEMCO	See yield in Ore Reserves table
Wessels	88%
Mamatwan	96%

(f) Ore delivered to process plant.

NICKEL

Table 7.42: Nickel Mineral Resources

As at 30 June 2014 (reported in 100 per cent terms)

Commodity Deposit ^(a)	Ore Type	Measured Resources		Indicated Resources		Inferred Resources		Total Resources		South32's Interest %
		Mt	% Ni	Mt	% Ni	Mt	% Ni	Mt	% Ni	
Nickel										
Colombia										
Cerro Matoso	Laterite	44	1.2	179	0.9	66	0.8	289	0.9	99.94
	SP	51	1.1	-	-	-	-	51	1.1	
	MNR Ore	17	0.2	-	-	-	-	17	0.2	

Table 7.43: Nickel Ore Reserves

As at 30 June 2014 (reported in 100 per cent terms)

Commodity Deposit ^{(a),(b),(c),(d)}	Ore Type	Proved Ore Reserves		Probable Ore Reserves		Total Ore Reserves		Reserve Life (years)	South32's Interest %
		Mt	% Ni	Mt	% Ni	Mt	% Ni		
Nickel									
Colombia									
Cerro Matoso ^(e)	Laterite	16	1.2	7.7	1.0	24	1.1	15	99.94
	SP	24	1.3	-	-	24	1.3		

(a) Cut-off grades:

Deposit	Ore Type	Mineral Resources	Ore Reserves
Cerro Matoso	Laterite, SP	≥ 0.6% Ni	≥ 0.7% Ni
	MNR Ore	≥ 0.12% Ni	-

(b) Approximate drill hole spacings used to classify the reserves were:

Deposit	Proved Ore Reserves	Probable Ore Reserves
Cerro Matoso	35m or less with three drill holes	35m to 100m with three drill holes

(c) Metallurgical recoveries for the operations were:

Deposit	Metallurgical Recovery
Cerro Matoso	82% (reserves to metal)

(d) Ore delivered to process plant.

(e) Cerro Matoso – Environmental licence approval required for the mine expansion project has been delayed, but is expected to be granted. Approval of both the Environmental and Social Impact Assessment and Mining Work Program Plan is a consultative process and forms part of the normal course of business.

SILVER, LEAD AND ZINC

Table 7.44: Mineral Resources

As at 30 June 2014 (reported in 100 per cent terms)																		
Commodity Deposit ^(a)	Ore Type	Measured Resources				Indicated Resources				Inferred Resources				Total Resources				South32's Interest %
		Mt	g/t Ag	% Pb	% Zn	Mt	g/t Ag	% Pb	% Zn	Mt	g/t Ag	% Pb	% Zn	Mt	g/t Ag	% Pb	% Zn	
Cannington	OC Sulphide	15	70	3.04	2.12	1.2	67	2.64	1.32	-	-	-	-	16	70	3.01	2.06	100
	UG Sulphide	42	226	6.18	3.86	11	147	4.51	3.04	6.7	98	3.52	2.00	60	197	5.57	3.50	

Table 7.45: Ore Reserves

As at 30 June 2014 (reported in 100 per cent terms)																
Commodity Deposit ^{(a),(b),(c),(d)}	Ore Type	Proved Ore Reserves				Probable Ore Reserves				Total Ore Reserves				Reserve Life (years)	South32's Interest %	
		Mt	g/t Ag	% Pb	% Zn	Mt	g/t Ag	% Pb	% Zn	Mt	g/t Ag	% Pb	% Zn			
Cannington	UG Sulphide	18	239	6.38	3.92	2.7	240	6.15	4.01	21	239	6.35	3.93	9.0	100	

(a) Cut-off grades:

Deposit	Cut-off Grades	Ore Type	Mineral Resources	Ore Reserves
Cannington		OC Sulphide	Net value incorporating material revenue and cost factors and includes metallurgical recovery (see footnote (d) in Table 7.45 for averages). Mineralisation at A\$45/t averages 27 g/tAg, 0.85% Pb and 0.90% Zn.	-
		UG Sulphide	Net value incorporating material revenue and cost factors and includes metallurgical recovery (see footnote (d) in Table 7.45 for averages). Mineralisation at A\$90/t averages 48 g/tAg, 1.66% Pb and 2.15% Zn.	Net value cut-off incorporating material revenue and cost factors and includes metallurgical recovery (see footnote (d) in Table 7.45 for averages). Mineralisation at A\$140/t averages 99 g/tAg, 4.40% Pb and 2.82% Zn.

(b) Approximate drill hole spacings used to classify the reserves were:

Deposit	Proved Ore Reserves	Probable Ore Reserves
Cannington	12.5m sectional x 15m vertical	25m sectional x 25m vertical

(c) Ore delivered to process plant.

(d) Metallurgical recoveries for the operations were:

Deposit	Metallurgical Recovery
Cannington	Ag 87%, Pb 86%, Zn 79%

7.3 DESCRIPTION OF JOINT VENTURES AND OTHER INTERESTS HELD BY SOUTH32

South32 holds interests in a number of joint ventures and has rights to a number of royalties. An overview of the key joint ventures and South32's royalties portfolio is set out below.

(a) Worsley Alumina

South32 holds an 86 per cent interest in the unincorporated Worsley Alumina joint venture operation (**Worsley Alumina JV**) together with Japan Alumina Associates (Australia) Pty Ltd (10 per cent) and Sojitz Alumina Pty Ltd (four per cent). These interests are held, and the Worsley Alumina JV is operated, under the terms of the Worsley JV arrangements (**WJVA**) comprising of: the Worsley Joint Venture Agreement (as amended), the Worsley Management Agreement (as amended) and the Worsley Joint Venture Arrangements – Binding Term Sheet.

The Worsley Alumina JV is managed by BHP Billiton Worsley Pty Ltd, the shares in which are held by the joint venturers in the same proportions as their individual interests in the Worsley Alumina JV. Output from the refinery is distributed to owners in proportion to their individual interest in the Worsley Alumina JV.

The ultimate decision-making body of the Worsley Alumina JV operations is the executive committee, which comprises representatives of each joint venturer, subject to joint venturers with a less than 10 per cent individual interest not being able to independently exercise a right to vote at the executive committee. Voting in respect of decisions by the executive committee effectively require a simple majority of individual interests with the exception of certain decisions relating to approval of programs and budgets, which require approval by one or more joint venturers holding in aggregate a proportionate share of 75 per cent or more, and certain other fundamental matters, which require unanimous approval.

(b) Mozal Aluminium

South32's interest in the Mozal S.A. joint venture (**Mozal Aluminium**) will be held through BHP Billiton Investment 1 B.V. (**B Co**). The other participants in the joint venture are Industrial Development Corporation of South Africa Limited (**IDC**), Mitsubishi Corporation (**Mitsubishi**) (through its subsidiary, MCA Metals Holding GmbH (**M Co**)) and the Government of the Republic of Mozambique. Mozal Aluminium owns the Mozal Aluminium smelter referred to in Section 7.1(c). The shares of Mozal Aluminium are currently owned by the joint venture partners as follows: B Co (47.1 per cent), M Co (25.0 per cent), IDC (24.0 per cent) and Mozambican Government (3.9 per cent, in the form of preference shares).

BHP Billiton, IDC and Mitsubishi also established a joint venture company called Aluminium Management Company of Mozambique Proprietary Limited to provide management, supervision and control services in respect of the operation of the Mozal Aluminium smelter, on behalf of Mozal Aluminium. The shares of Aluminium Management Company of Mozambique Proprietary Limited are currently owned by the joint venture partners as follows: B Co (49 per cent), M Co (26 per cent) and IDC (25 per cent).

Pursuant to various long-term off-take agreements, Mozal Aluminium sells 100 per cent of its aluminium products to South32 Marketing, IDC and Mitsubishi Corporation (a subsidiary of Mitsubishi).

These off-take agreements expire on 31 December 2025. Each of IDC and Mitsubishi Corporation is entitled to the aluminium production of Mozal Aluminium in proportion to its respective shareholding in Mozal Aluminium. South32's marketing function (**South32 Marketing**) currently acquires 51 per cent of the aluminium production of Mozal Aluminium, which is equal to B Co's shareholding and the Mozambican Government's preference shareholding in Mozal Aluminium combined. The Mozambican Government's off-take allocation is vested in B Co under the Mozal Aluminium shareholders' agreement. All cash distributions and dividend declarations are required to comply with the Mozal Aluminium shareholders' agreement.

(c) Brazil Aluminium – Alumar and MRN

South32's Brazilian Aluminium business interests are held through its wholly-owned subsidiary BMSA.

Through an unincorporated Brazilian consortium with Alcoa and Rio Tinto Alcan, BMSA holds a 36 per cent interest in the Alumar refinery and a 40 per cent interest in the Alumar aluminium smelter referred to in Section 7.1(d). Alcoa (together with its affiliate Alcoa World Alumina Brasil Ltda) owns in aggregate a 54 per cent interest in the alumina refinery and a 60 per cent interest in the aluminium smelter. Rio Tinto Alcan owns the remaining 10 per cent interest in the alumina refinery. The operations, together with their integrated port facility, are known as Alumar and are operated by Alcoa. A consortium agreement governs the rights and obligations of the consortium partners with respect to the management and raw material and capital requirements of the Alumar consortium and their respective interests in the Alumar consortium.

In addition, BMSA owns a 14.8 per cent equity interest in MRN, a Brazilian corporation that operates the MRN Mine, a bauxite mine in the Trombetas region, Pará, Brazil, referred to in Section 7.1(d). The other shareholders in MRN are Alcoa and affiliates (18.2 per cent), Vale (40 per cent), Rio Tinto Alcan (through Alcan Alumina Ltda) (12 per cent), Companhia Brasileira de Alumínio S.A. (10 per cent) and Norsk Hydro (through Norsk Hydro Brasil Ltda) (five per cent). BMSA sources from MRN the bauxite needed to operate its share of the Alumar consortium's alumina refinery. MRN is independently managed by its board of directors and executive board. The shareholders of MRN have entered into a shareholders' agreement to govern their participation in MRN. MRN is partially funded by external debt.

MRN sells bauxite to its shareholders and their associates under long-term contracts. The price of bauxite under these contracts (the setting of which requires the approval of MRN's shareholders) has reference to the recovery of MRN's costs and other funding obligations and is therefore subject to revision having regard to (among other things) MRN's obligations under its external debt arrangements.

(d) Manganese Business Entities

Following implementation of the Demerger, South32 will hold a 60 per cent interest in Samancor Holdings (Pty) Limited, Groote Eylandt Mining Company Pty Ltd and Samancor AG (together, **Manganese Business Entities**). The remaining 40 per cent is held by Anglo American plc and its subsidiaries. These interests are held, and the Manganese Business Entities are operated, under the terms of an Amended and Restated Umbrella Agreement. South32 has agreed to acquire BHP Billiton's interests in the Manganese Business Entities. The last of these acquisitions is due to complete on or about 8 May 2015 (the **Novation Date**), subject to approval of the Demerger Resolution.

The Amended and Restated Umbrella Agreement was entered into on 19 August 2014, amending and restating the original Umbrella Agreement between BHP Billiton and Anglo American plc. On the Novation Date, South32 will replace BHP Billiton as a party to the Amended and Restated Umbrella Agreement (and the Management Agreement referred to below).

Under the Amended and Restated Umbrella Agreement, South32 and Anglo American plc will be obliged to conduct their worldwide manganese mining, processing, marketing and trading activities exclusively through the Manganese Business Entities. The ultimate decision-making body under the Amended and Restated Umbrella Agreement is the supervisory committee. Certain key decisions require unanimous approval.

From the Novation Date, South32 will be the exclusive manager of the mining operations of the Manganese Business Entities under a Management Agreement and will provide marketing services in respect of manganese production under Marketing Services Agreements. The Management Agreement contains provision for management fees.

South32 will have day-to-day conduct of the business subject to matters reserved to the supervisory committee. South32 and Anglo American plc will have equal representation and voting rights on the supervisory committee.

(e) South32 royalties portfolio

South32 holds the rights to a portfolio of minerals royalties receivable that is diversified by commodity and country of origin. Royalty income is not currently being received for the majority of the royalties as they relate to projects that are not currently in production.

7.4 SOUTH32 MARKETING

South32 Marketing is responsible for the organisation's sales and distribution activities. The marketing activities include:

- sale of South32's commodities and purchase of selected raw material inputs;
- optimising the supply chain for delivery flow of commodities to both internal and external customers;
- working closely with the South32 Businesses to maximise the value from the resource base;
- defining the company's view of the long-term markets;
- maximising revenue and managing price and credit risk.

Management of South32's marketing function is based in Singapore, with a regional office in London, and a presence in South Africa and Switzerland. The core activities described above are supported by the key functional services of governance, compliance and financial performance reporting.

South32's marketing activities are geared towards:

- identifying marketing and pricing opportunities using knowledge accumulated by South32 across the supply chain and various geographical locations it operates;
- taking advantage of the substantial financial resources and market and commodity knowledge accumulated within South32;
- efficiently managing logistics and handling of commodities from load point to customer.

South32's involvement as a producer, refiner and marketer of commodities allows it to minimise costs and maximise efficiencies, maximising returns across the supply chain. A fully integrated marketing function also allows South32 to deliver a differentiated sales proposition to its customers relative to other producers and allows South32 to optimise its supply chain to meet customer needs.

7.5 EMPLOYEES

Immediately following the Demerger, South32 will have a workforce totalling approximately 27,000 people globally. As at 31 December 2014, South32 employed approximately 15,000 FTE employees in the businesses, assets and offices to be managed by South32 and a further approximately 12,000 contractors were engaged by these operations.

(a) Description of workforce

Given the diverse nature of South32's operations, the roles and functions of South32's employees and contractors vary across South32. There are four main categories of employees as shown below:

Table 7.46: South32 employees by category

Employees by category	%
Senior leaders	0.4
Managers	2.0
Supervisory and professionals	4.9
Operators and general support	92.7

Contractors are not shown in the table above, but perform services that would fall within the operators and general support category only.

(b) Employment arrangements

The employment arrangements with respect to employees in South32 Businesses in Australia, South Africa, Colombia, Singapore and Mozambique are set out below.¹

(1) Australia

The National Employment Standards underpin the terms and conditions of all Australian employees.

The majority of South32's Australian employees have terms and conditions of employment governed by an enterprise agreement or a modern award.

Enterprise agreements are agreements between a company and its employees that set out the conditions of employment and are approved by the Fair Work Commission.

South32 is a party to 24 enterprise agreements which collectively cover approximately 50 per cent of its Australian workforce.

Where an enterprise agreement is in place, it applies instead of a modern award (being industry or occupation based minimum employment standards) and the pay rate in an enterprise agreement must not be less than the pay rate in the relevant modern award.

(2) South Africa

South32's South African operations employees have terms and conditions of employment that are governed by the Basic Conditions of Employment Act of South Africa (**BCEA**) and their individual contracts of employment. Some of the terms and conditions of employment of some employees are regulated by collective agreements, which are negotiated with the applicable trade unions.

The BCEA is the principal statute giving effect to statutory minimum terms and conditions of employment. It is, in effect, a default set of conditions of employment, unless the conditions of employment provided for in employment contracts or in collective agreements are more favourable to employees. The BCEA also establishes mechanisms for the variation of basic conditions through individual agreement, collective agreements and sectoral agreements.

Collective agreements are written agreements, which vary contracts of employment and cover mainly less experienced employees.

(3) Colombia

All employment matters covering South32 and all businesses in Colombia are governed by the Substantive Labor Code, which regulates matters such as individual employment agreements, mandatory social benefits, annual leave, supplementary work, days of rest, union organisations and collective bargains; and the Social Security Regime, which regulates obligations related to affiliation with (and quotations to) the social security system for health, pension and occupational risks.

CMSA and the union of which employees at Cerro Matoso are members entered into a collective bargaining agreement that expires in December 2015. The collective bargaining agreement covers the majority of employees including all unionised and non-unionised CMSA employees, except for those holding managerial positions.

¹ Arrangements with employees in South32 Businesses in other countries have not been set out below given the small number of employees in these locations.

(4) Singapore

The terms and conditions of employment of the employees in South32's operations in Singapore will be primarily governed by their respective common law contracts of employment, including any South32 policies forming part of the contract.

The Singapore Employment Act 1968 prescribes some minimum terms and conditions of employment but the Act has limited application to South32's employees.

(5) Mozambique

The employees of South32's operations in Mozambique have terms and conditions of employment that are governed by both the applicable labour law (Project of Labour Law) and a collective bargaining agreement 'Mozaal Wages Agreement' executed in 2013 between Mozaal Aluminium and the Sintime union.

Most of the key terms and conditions applicable to the employment relationship, including remuneration principles, working hours and other conditions of employment, are determined by the general labour law and the individual employment contracts entered into between the employer and its employees. The collective agreement specifies the relationship between the union, as representative of the employees, and South32, and sets guidelines with regard to issues such as the level of salaries and their negotiation, minimum services commitments, disputes procedures and other general employment issues.

The execution of the individual employment contracts also follows the existing internal guidelines on remuneration, conditions of employment and employee benefits for Mozaal Aluminium employees.

(c) Employee relations

All South32 operations and offices seek to maintain safe and productive workplaces underpinned by employee relations principles and direct employee engagement and alignment. Employee relations are managed by each operation within a South32-wide governance framework.

South32's relationships with its employees and its other stakeholders are built on mutual respect. Due to the breadth and geographical diversity of South32, its employees operate under a range of legislative regimes and its employment arrangements range from collective to individual contracts. South32 recognises the right of its employees to freely associate and collectively bargain where they choose to do so. Approximately 50 per cent of South32's total employees are covered by long-term collective agreements, and labour unions are represented at many of South32's operations.

South32 engages in direct communication and responds to issues raised by employees and unions, including those related to health and safety matters, remuneration, working hours and roster arrangements. South32 also works closely with contracting companies and encourages them to ensure their employee relations are governed in a manner consistent with the South32 approach.

In line with South32's employee relations approach, South32 believes having employees directly engaged with South32 and aligned with South32's goals is the most effective way of ensuring harmonious operations.

South32 leadership believes that relationships with employees across all operations are productive as evidenced by the fact that there was no industrial disruption of greater than one week, continuously or cumulatively, in FY2014.

(d) South32 employee relations strategy

From the date of the Demerger, South32 intends to adopt an employee relations strategy which will aim to:

- ensure respectful and fair treatment of all employees;
- eliminate negative, disrespectful, disruptive or inefficient behaviours and practices;
- harness the benefits of workplace diversity;
- build a workplace culture that recognises high performance;
- introduce workplace change in a consultative manner;
- provide timely, open, honest communication at all levels;
- empower and train supervisors and managers to provide strong leadership and act as role models;
- maintain fair and responsive dispute resolution procedures that achieve effective resolution of workplace issues.

However, as in any business comprising a large workforce, there is a risk that South32's operations may be affected by disputes with employees and unions. South32 minimises the risks of such disputes by ensuring South32 management maintains a frequent and open dialogue with employees and their unions. Further information on the risk of industrial action can be found in Section 2.2(g).

(e) Superannuation

South32 operates a number of pension plans and post-retirement healthcare plans around the world. Some of these plans are defined contribution and some are defined benefit in nature. For funded plans, assets are held in separate trusts, governed by local regulations and practice.

7.6 GOVERNMENT REGULATION OVERVIEW

Government regulations touch various aspects of South32's operations. However, the geographical diversity of South32's operations reduces the risk that any one set of government regulations would have a material effect on its business, taken as a whole.

The ability to extract minerals will be fundamental to South32. In most jurisdictions, the rights to undeveloped mineral deposits are owned by the state. In those jurisdictions, South32 relies upon the rights granted to it by the government that owns the mineral rights. These rights usually take the form of a lease or licence, which gives South32 the right to access the land and extract the product. The terms of the lease or licence, including the time period for which it is effective, are specific to the laws of the relevant jurisdiction. Generally, South32 owns the product it extracts, and royalties or similar taxes are payable to the government.

Related to the ability to extract is the ability to process the minerals. Again, South32 relies upon the relevant government to grant the rights necessary to transport and treat the extracted material in order to ready it for sale.

Underlying South32's business of extracting and processing natural resources is the ability to explore for those natural resources. Typically, the rights to explore for minerals are granted to South32 by the government that owns those natural resources that it wishes to explore. Usually, the right to explore carries with it the obligation to spend a defined amount of money on the exploration or to undertake particular exploration activities.

Governments also impose obligations on South32 in respect of environmental protection, land rehabilitation, occupational health and safety, and rights and interests of Indigenous peoples with which South32 must comply in order to continue to enjoy the right to conduct its operations within that jurisdiction. These obligations often require South32 to make substantial expenditures to minimise or remediate the environmental impact of its operations and to ensure the safety of its employees, contractors and neighbouring communities. Environmental protection, land rehabilitation and occupational health and safety practices in most jurisdictions in which South32 operates are principally regulated by the government and to a lesser degree, if applicable, by the lease contract with the landowner.

7.7 HEALTH, SAFETY, ENVIRONMENT AND COMMUNITY

(a) Objectives

South32 aims to be a business that lives by its values, is socially and environmentally responsible and provides a better future for South32's host communities. South32 will seek to achieve this through leaders and employees who stand for and live the values and implement appropriate systems to ensure safe, predictable and effective operations. Not only does South32 believe this is essential to maintain its licence to operate, but it considers that this has been and will continue to be one of its competitive advantages.

South32 believes that its strength will come from its workforce diversity and an inclusive workplace culture and environment where employees can meet their professional and personal development priorities.

South32's HSEC governance and risk management framework is set out below:

(1) Governance and sustainability

The South32 Board will establish a Sustainability Committee to assist in the oversight of HSEC and sustainability matters. This includes overseeing areas relating to risk control, compliance with applicable legal and regulatory requirements and with overall HSEC and sustainability performance of South32.

(2) Risk management

In addition to the legal requirements of the countries in which South32 operates, Corporate Standards will outline South32's approach to managing risks, including HSEC and sustainability risks. These documents will describe the mandatory minimum performance requirements and accountabilities across South32 and will be the foundation for developing and implementing risk controls across operations.

South32 will develop Corporate Standards which will also define its commitments to international policies, standards and selected management practices. South32's Risk Management Corporate Standard will provide the framework for embedding risk management into business activities, functions and processes.

(3) Commitment to integrity and transparency

South32 is committed to ethical business practices and high levels of governance and transparency in all its dealings. In support of this commitment, South32 intends to:

- issue an annual sustainability report using the Global Reporting Initiative framework from FY2016;
- report payments of taxes and royalties derived from resource developments on a country-by-country basis, consistent with South32's support for the Extractive Industries Transparency Initiative and the importance of transparency of government revenue from the extraction of natural resources in the fight against corruption.

(b) Environment

South32 acknowledges the relationship between sustainable natural resource use and conservation and will demonstrate this by minimising its environmental impacts and contributing to enduring environmental conservation projects.

(1) Climate Change

South32 accepts the findings of the Intergovernmental Panel on Climate Change, in particular, that human activity impacts the climate and that physical effects are unavoidable. South32 intends to take actions to reduce emissions and support regulations to counter the effects of climate change. South32 recognises:

- the risk that climate change poses to the South32 Business and is committed to reducing its emissions;
- the importance of improving living standards by providing access to affordable, reliable energy, but South32 is transparent about the challenge that this presents in meeting climate change objectives;
- the role of government as policymakers and will work with industry bodies to support development of effective, long-term policy frameworks.

South32 will continually look for opportunities to improve its energy efficiency with a specific focus on the energy and greenhouse gas emissions-intensive smelting assets.

Carbon pricing will be a key consideration in all of South32's current and future investment decisions. Governments globally are considering a variety of legislative and regulatory options to mitigate greenhouse gas emissions. South32 will engage with relevant governments in order to provide its views and perspective on any policy and the impacts it may have for South32 given its trade-exposed and energy intensive position.

(2) Biodiversity and land management

South32 will develop land and biodiversity management plans which specify measures to avoid, minimise, rehabilitate and apply compensatory actions as appropriate to manage the biodiversity and ecosystem impacts of its operations.

(3) Water Resource Management

South32 will seek to ensure effective management of the water resources it shares with its host communities and the environment.

South32 Businesses will be required to assess direct, indirect and cumulative impacts and risks to water resources by understanding the social, cultural, ecological and economic values of these resources within their area of influence.

Where water is identified as a material risk, South32's operations will be required to implement projects to improve the management of water resources to focus on the water challenges specific to the regions in which they operate.

(4) Closure planning

South32 recognises the significant potential risks associated with poorly managed closure activities and seeks to minimise these throughout the life cycle of its operations. South32 operations will be required to develop and maintain closure plans that address the details of rehabilitation activities for disturbed land, remediation requirements for contaminated land, and end uses for land and infrastructure. Closure plans will be also required to include community impacts post-closure. In addition, South32 will require closure plans to be developed as part of its major capital investments to ensure potential closure liabilities are understood and, where possible, reduced during the design stage. Closure plans will provide the basis for estimating costs and associated accounting for closure and rehabilitation obligations.

(c) Safety

South32's aspiration is to ensure that no person at work will be seriously hurt. Work will be well designed, planned, executed, supervised and improved by trained and competent people. All key processes and equipment will be governed by standards, and compliance to these standards is periodically tested and verified.

South32 will implement a consistent risk management process at its operations that ensures:

- appropriate controls are implemented and effective;
- systems are implemented to identify and effectively manage foreseeable crises and emergencies, ensuring South32's operations can deal with potential casualties, to limit harm and to safely return to full function as soon as possible.

(d) Health

South32's priority is to ensure that employees and contractors are not exposed to harmful occupational health risks with a primary focus on controlling occupational exposures at their source. In situations where South32 cannot control the source, a range of measures will be employed, including the provision of personal protective equipment to safeguard its people.

Health risks faced by South32's people include fatigue and occupational exposures to noise, manganese, carcinogenic substances, such as silica, diesel exhaust particulate matter, nickel, sulphuric acid mist, fluorides and coal tar pitch.

South32 will have processes in place to make sure its people are fit for work and all operations have systems in place to minimise the risk of health exposures. The health risks faced by South32 Businesses are set out in further detail in Section 2.5(a)(1).

(e) Community

South32 will make a positive contribution to the quality of life of the communities, regions and countries where it operates. South32 will work with its local communities to better understand and manage the impact of its operations and to maximise the opportunities South32 has to help make these communities great places to live and work.

This will be done by:

- **Developing stakeholder engagement plans:** Stakeholder engagement plans identify the interests and relationships of the stakeholders in the host communities within which South32 operates. These plans will contain a range of culturally and socially inclusive engagement activities to ensure open communications are maintained.
- **Making a positive contribution to society:** Wherever South32 operates, it will contribute by:
 - paying taxes and royalties to governments, which in turn are used to provide important public services and amenities to their communities;
 - providing employment and procurement opportunities to its local communities.
- **Recognising Indigenous communities and respecting customary rights:** South32 will recognise the traditional rights and values of Indigenous peoples, respect their cultural heritage and provide opportunities for inclusion and advancement. Many of South32's operations are located on or near Indigenous lands. South32 will:
 - provide cultural awareness and competency training for employees who engage with Indigenous peoples from host communities;
 - implement Indigenous engagement programs that are consistent with the ICMM Position Statement on Indigenous Peoples and Mining (which comes into effect in May 2015).
- **Committing to business practices which observe and respect human rights:** South32 acknowledges its activities have the potential to impact human rights. South32 Businesses will be required to complete a human rights impact assessment to ensure potential risks are identified and measures are in place to effectively manage and mitigate these risks.

Through South32's commitment to the Voluntary Principles on Security and Human Rights, South32 will seek to protect people and property from risks presented by security threats.

8 DIRECTORS, SENIOR MANAGEMENT AND CORPORATE GOVERNANCE

Following implementation of the Demerger, South32 will have a Board of Directors and a senior management team with the combined skill and experience to discharge their respective responsibilities in a publicly listed, global, diversified metals and mining company.

In determining the number of South32 Directors, the workload of the South32 Board and its committees and the skills and experiences necessary to effectively govern South32 have been taken into account. Directors have been sought who together reflect industry expertise in the mining, refining, smelting and processing areas, as well as experience in the five countries in which South32 has assets and the jurisdictions where South32 Shares will be listed. It is intended that the initial composition of the South32 Board following the Demerger will reflect a range of geographical backgrounds, including Australia, South Africa and the United Kingdom. Regard has also been had for the need for diversity, in its broadest context.

David Crawford will be the Chairman of South32. The appointment has regard to Mr Crawford's deep governance experience, including his skill and experience in the areas of risk and financial controls both in the metals and mining sector and other industries, which are considered particularly important in the early years of South32's life. Keith Rumble and Xolani Mkhwanazi have also been asked to join the South32 Board as Non-executive Directors. Both have deep commercial experience in both the metals and mining sector and in the regions where South32 will operate, especially South Africa.

Graham Kerr will lead South32 as its first Chief Executive Officer. Mr Kerr has been a long-term employee of BHP Billiton with his most recent assignment being Chief Financial Officer. In addition to his financial expertise he brings operational experience, having run one of BHP Billiton's businesses based in the United Kingdom and Canada. He has participated in BHP Billiton's extensive talent and development programs for many years. His leadership skills have been recognised, as has his potential to succeed to the most senior leadership roles. He takes with him BHP Billiton's commitment to health and safety and its rigorous financial and operational disciplines.

Other members of the executive team who will leave BHP Billiton and join South32 (Brendan Harris, Ricus Grimbeek, Mike Fraser and Nicole Duncan) have all participated in BHP Billiton's talent and development programs. They have been selected for the respective operational and functional skills they will bring to their new roles and for their alignment with BHP Billiton's charter values. They are considered the best people for these crucial roles.

Biographies for these proposed directors and senior management of South32 are set out below.

South32 intends to appoint additional Non-executive Directors in time.

As part of its commitment to South Africa, South32 has given undertakings to the FinSurv Department that, among other things, the South32 Board and management team of South32 will include strong South African representation, South32 Board meetings will be regularly convened in South Africa and South32's African operations will be managed from a regional head office in South Africa.

8.1 DIRECTORS

(a) Biographies

As at the date of this document, the known members of the South32 Board at the ASX Listing Date are:

Table 8.1: South32 Directors

Name	Age	Nationality	Position
David Crawford	71	Australian	Chairman and Independent Non-executive Director
Graham Kerr	43	Australian	Chief Executive Officer and Executive Director
Keith Rumble	60	South African	Independent Non-executive Director
Xolani Mkhwanazi	59	South African	Non-executive Director

(1) David Crawford AO, BComm, LLB, FCA, FCPA, 71

Chairman and Independent Non-executive Director

Mr Crawford will be the Chairman of South32.

Mr Crawford has extensive experience in risk management and business reorganisation. He has acted as a consultant, scheme manager, receiver and manager and liquidator to very large and complex groups of companies. Mr Crawford was previously Australian National Chairman of KPMG, Chartered Accountants.

Other directorships and offices (current and recent):

- Chairman of Australia Pacific Airports Corporation Limited (since May 2012).
- Chairman of Lend Lease Corporation Limited (since May 2003) and director (since July 2001).

- Former director of BHP Billiton Limited (from May 1994 to November 2014) and BHP Billiton Plc (from June 2001 to November 2014).
- Former Chairman (from November 2007 to December 2011) and former director (from August 2001 to December 2011) of Foster's Group Limited.

(2) Graham Kerr, BBus, FCPA, 43

Chief Executive Officer and Executive Director

Mr Kerr joined BHP Billiton in 1994 and was appointed Chief Financial Officer in November 2011. Mr Kerr retired from the BHP Billiton Group Management Committee, and as Chief Financial Officer of BHP Billiton, on 1 October 2014. Prior to his appointment as Chief Financial Officer of BHP Billiton, Mr Kerr was President of Diamonds and Specialty Products. Mr Kerr has worked in a wide range of operational and commercial roles across the BHP Billiton Group.

As President of Diamonds and Specialty Products, Mr Kerr was accountable for the EKATI Diamond Mine in Canada, the Richards Bay Minerals Joint Venture in South Africa, diamonds exploration in Angola, the Corridor Sands Project in Mozambique and the development of BHP Billiton's potash portfolio in Canada. Prior to that Mr Kerr held the positions of Chief Financial Officer of Stainless Steel Materials, Vice President Finance BHP Billiton Diamonds and Finance Director for the BHP Canadian Diamonds Company. In 2004 Mr Kerr left BHP Billiton for a two-year period when he was General Manager Commercial for Iluka Resources Ltd.

(3) Keith Rumble, BSc, MSc (Geology), 60

Independent Non-executive Director

Mr Rumble was previously Chief Executive Officer of SUN Mining, a wholly-owned entity of the SUN Group, a principal investor and private equity fund manager in Russia, India and other emerging and transforming markets. Mr Rumble has more than 30 years' experience in the resources industry, specifically in titanium and platinum mining, and is a former Chief Executive Officer of Impala Platinum (Pty) Ltd and former Chief Executive Officer of Rio Tinto Iron and Titanium Inc in Canada. Mr Rumble began his career at Richards Bay Minerals in 1980 and held various management positions before becoming Chief Executive Officer in 1996.

Mr Rumble will retire from the BHP Billiton Board at or around the time of the BHP Billiton Shareholder vote on the Demerger Resolution.

Other directorships and offices (current and recent):

- Director (non-executive) of BHP Billiton Limited and BHP Billiton Plc (since September 2008).
- Director of Enzyme Technologies (Pty) Limited (since September 2011).
- Director of Elite Wealth (Pty) Limited (since August 2010).
- Board of Governors of Rhodes University (since April 2005).
- Trustee of the World Wildlife Fund, South Africa (since October 2006).
- Former director of Aveng Group Limited (from September 2009 to December 2011).

(4) Xolani Mkhwanazi, BSc, MSc, PhD (Applied Physics), 59

Non-executive Director

Dr Mkhwanazi joined BHP Billiton in February 2005 as President and Chief Operating Officer South Africa Aluminium. Dr Mkhwanazi was appointed Chairman of BHP Billiton in South Africa in 2009. Dr Mkhwanazi previously served as Chief Executive Officer of Bateman Africa Ltd and the National Electricity Regulator. Prior to that, he held senior positions at the Council for Scientific and Industrial Research. During this period, he played a key role in the formulation of South African National Science and Technology Policy. In his early career, Dr Mkhwanazi was a Senior Scientist at the Atomic Energy Corporation and Head of the Physics Department at the University of Swaziland.

(b) Remuneration

South32 intends to remunerate its Non-executive Directors at the level necessary to attract and retain high-quality individuals, to reflect the size and complexity of South32, and considering the anticipated workload and time commitment of the role. In setting its fees, South32 will take advice from an appropriately qualified independent remuneration adviser.

The initial maximum aggregate amount available for fees for Non-executive Directors as approved by BHP Billiton as shareholder prior to listing will be A\$3,900,000 per annum. In accordance with the ASX Listing Rules and South32's Constitution, South32 will seek shareholder approval for changes to the maximum aggregate amount available for fees for Non-executive Directors. Executive Directors of South32 will be remunerated in their capacity as executives and their remuneration will not contribute towards the maximum aggregate amount.

Non-executive Directors will receive additional fees, from within the maximum aggregate approved amount, for services as chairs and members of South32 Board committees. The Chairman of the South32 Board will not receive any additional fees for his participation in South32 Board committees. The initial fees to be paid to the South32 Chairman and Non-executive Directors (which will include superannuation contributions) will be:

Table 8.2: Director and committee Fees

	A\$ Per annum^(a)
Chairman ^(b)	550,000
Non-executive Directors (excluding the Chairman)	180,000
Chair of Risk and Audit Committee	45,000
Chair of Remuneration Committee	45,000
Chair of Sustainability Committee	45,000
Member of Risk and Audit Committee	22,500
Member of Remuneration Committee	22,500
Member of Sustainability Committee	22,500

(a) These fees were set after considering fee levels for comparable roles in companies of similar complexity, size, geographic footprint, listing jurisdictions, reach and industry. They reflect the responsibilities, location, qualifications and experience considered necessary to discharge the responsibilities of the Board. In assessing the appropriate fee level independent advice was sought from appropriately qualified experts. US dollar fees of US\$500,000 per annum for the Chairman and US\$160,000 per annum (base) for Non-executive Directors were endorsed. The Australian dollar fees were derived after applying an exchange rate of US\$0.90 per Australian dollar. While a matter for South32, it is expected that Directors domiciled in locations outside Australia will be offered the choice of having fees denominated in Australian dollars or the currency of domicile.

(b) Mr David Crawford was announced as the proposed Non-executive Chairman of South32 in August 2014. Mr Crawford was subsequently appointed as a Non-executive Director and Chairman of South32 on 2 February 2015 in order to assist in the implementation of the Demerger. Mr Crawford will receive total fees of approximately A\$171,000 in respect of his services to South32 in the period leading up to the Demerger (estimated for the period 2 February to 26 May 2015). These fees reflect the level of assistance provided and have been derived from the annual Chairman's fee of A\$550,000 above, prorated for the time period up to the date of Demerger.

Non-executive Directors are not eligible to participate in any short-term or long-term incentive arrangements and there are no provisions in any of the Non-executive Directors' appointment arrangements for compensation payable on early termination of their directorship.

Non-executive Directors will apply 25 per cent of their fees to the purchase of South32 Shares until they achieve a minimum shareholding level of one year's fees. Thereafter, they must maintain at least that minimum shareholding level of one year's fees throughout their tenure.

Recognising the global nature of South32, travel allowances will be provided for extended travel for Board business. The remuneration of the Chief Executive Officer is summarised in Section 8.2(b).

(c) Director and officer indemnity arrangements

South32 intends to enter into a deed of indemnity, insurance and access with each of the South32 Directors. These deeds will indemnify the South32 Directors against liability to any person (other than South32 or a related body corporate) that may arise from their acting as an officer of South32. There is an exception to the indemnity where the liability arises out of conduct involving a lack of good faith, or is otherwise prohibited by law.

8.2 SENIOR MANAGEMENT

(a) Biographies

South32 will be led by an experienced and capable management team which has a deep understanding of South32's business. Key members of South32's senior management team will include:¹

(1) Graham Kerr, BBus, FCPA, 43

Chief Executive Officer and Executive Director

In August 2014, Mr Kerr was appointed as Chief Executive Officer (**CEO**) designate of South32. Information about Mr Kerr is contained in Section 8.1(a)(2).

(2) Brendan Harris, BSc, 43

Chief Financial Officer

Mr Harris joined BHP Billiton as Vice President Investor Relations Australasia in July 2010 and was appointed Head of Investor Relations in July 2011. Prior to joining BHP Billiton he held various roles in investment banking over almost a decade including Executive Director Metals and Mining Research, Macquarie Equities, where he had primary responsibility for Australian listed metals and mining research. During Mr Harris' early career as an exploration geologist he was involved in iron ore exploration in the Pilbara region of Western Australia with Robe River Iron Associates and gold and base metals exploration in the Gawler Craton in South Australia. Mr Harris also gained experience with Western Geophysical in Perth, Western Australia where he participated in the reprocessing of seismic data. Mr Harris holds a Bachelor of Science in geology and geophysics.

¹ In addition to senior management personnel discussed below, Jo McConnell was appointed as Acting Chief People Officer of South32.

(3) Ricus Grimbeek, BEng, 45

President and Chief Operating Officer, Australia

Mr Grimbeek joined BHP Billiton in February 1992 as a Mining Engineer in training. Mr Grimbeek's career has spanned numerous technical and operating roles within and outside the company including time as the Executive Vice President Mining for Lonmin Platinum. Mr Grimbeek was the Head of Group HSEC from April 2009 to October 2011 and President and Chief Operating Officer of the EKATI Diamond Mine in Canada from May 2007 to March 2009. In November 2011, he was appointed Asset President, Worsley. Mr Grimbeek holds a Mining Engineering degree from the University of Pretoria and an Advanced Certificate in Mine Ventilation from the Chamber of Mines.

(4) Mike Fraser, BCom, MBL, 49

President and Chief Operating Officer, Africa

Mr Fraser joined BHP Billiton in January 2000 as Head of Compensation and Benefits. Mr Fraser was appointed President, Human Resources and a member of the Group Management Committee in August 2013. Previously Mr Fraser led BHP Billiton's Mozal operation in Mozambique as Asset President from September 2009 to October 2012. Prior to taking up this role Mr Fraser worked across a number of roles in BHP Billiton's Coal, Manganese and Aluminium businesses in a number of geographies. Prior to joining BHP Billiton Mr Fraser held a variety of leadership roles in a large internationally diversified industrial business. Mr Fraser holds a Master of Business Leadership and a Bachelor of Commerce from the University of South Africa.

(5) Nicole Duncan, BA (Hons), LLB, 43

Chief Legal Officer and Company Secretary

Ms Duncan joined BHP Billiton in July 2000 as a Counsel in Group Legal and was appointed Vice President, Company Secretariat in September 2013. Prior to this role, Ms Duncan held various legal and commercial roles within BHP Billiton. Ms Duncan was Vice President, Supply, Group Information Management from October 2011 to August 2013. Previously, Ms Duncan held the role of Senior Manager, Group Legal, supporting the marketing function and prior to that played a key role in operations, major expansions and merger and acquisition projects. Prior to joining BHP Billiton, she was a lawyer at Ashurst (formerly Blake Dawson Waldron) in Melbourne. Ms Duncan graduated from the Australian National University with a degree in Law and an Honours degree in History.

(b) Remuneration

The South32 Board recognises that remuneration will have an important role to play in supporting the implementation and achievement of South32's strategy and ongoing performance. It will be designed to align the activities of management to the interests of shareholders.

Remuneration will be set at a level that takes into account responsibilities, location, skills, experience and performance.

The key principles that underpin the design of remuneration arrangements are:

- support the execution of South32's strategy in alignment with its risk framework;
- be market competitive and designed to attract, retain and motivate talented individuals and teams, without paying more than is necessary;
- comprise fixed and at-risk components which link a significant proportion to performance and the creation of value for shareholders;
- apply demanding performance conditions to at-risk components, including financial and non-financial measures;
- limit termination benefits to pre-agreed contractual and approved obligations;
- be equitable and be set having regard to the expectations of shareholders.

South32's remuneration arrangements will be designed to ensure that executives take a long-term approach to decision-making, and do not promote a focus on short-term results at the expense of longer-term business growth and success.

A significant portion of total remuneration for the CEO and other members of senior management will be accrued and paid in accordance with the terms and conditions of the South32 Equity Incentive Plan. The South32 Equity Incentive Plan is intended to be established shortly after the implementation of the Demerger on the terms and conditions more fully described in Section 8.7(a) below. Accordingly, a significant portion of total remuneration for the CEO and other members of senior management will be at-risk (that is, dependent largely on the performance of the business of South32). In the case of the CEO, 71 per cent of his total target remuneration is at-risk. The equity component of an award under the short-term incentive (**STI**) plan will be deferred for an additional period. Performance under the long-term incentive (**LTI**) plan will be measured over an extended period aligned with South32's strategy. The actual rewards received by the CEO and other members of senior management will therefore reflect South32's performance and share price over a prolonged time frame.

While the performance conditions attaching to both the STI and the LTI will be a matter for the Board of South32, the structure has been designed to provide an appropriate focus on South32's sustained performance beyond the end of the initial measurement period. This approach will also provide a transparent mechanism for clawback or adjustment in the event of a restatement of South32's results through changes to the vesting or non-vesting of deferred awards.

An important feature of the remuneration arrangements is that they will not be driven by a purely formulaic approach. The South32 Board will hold discretion to determine that awards are not provided or vested in circumstances where it would be inappropriate to do so.

The remuneration of the CEO, which is set out in Table 8.3 below, was set having regard to remuneration levels for comparable roles in global companies of similar complexity, size, geographic footprint, listing jurisdictions, reach and industry. It was assessed against levels in the 10th-40th largest companies on the ASX by market capitalisation. Reference was also had to an international resources peer group for this role. The level reflects the CEO's responsibilities, location, qualifications and experience. Advice was sought from appropriately qualified experts and guidance derived from the principles outlined in Section 8.2(b) above.

Table 8.3: CEO annual target remuneration

The STI is entirely performance based and comprises half cash STI and half deferred STI. It will be based on a scorecard of financial and non-financial measures for each year. This target is 120 per cent of base salary. The maximum is 180 per cent of base salary (or A\$3.186 million).

		Base salary	STI (target)	LTI (fair value)	Total
Graham Kerr ^(a)	A\$ ('000)	1,770	2,124	2,177	6,071
	%	29	35	36	100

The CEO will earn this amount as base salary. It includes minimum superannuation contributions required by law. There is no pension payment in addition to this sum.

The LTI is entirely performance based and aligned to shareholder interests. This value is based on 300 per cent face value of base salary together with a fair value estimate taking into account an estimated 41 per cent probability of vesting over the performance period. The actual value of this LTI award cannot be determined until after the end of the performance period. The maximum value at grant date that can be received from the LTI is 300 per cent of base salary (or A\$5.310 million).

■ At-risk remuneration
 ■ Fixed remuneration

(a) Remuneration was first determined in US dollars to allow for effective benchmarking and converted to Australian dollars by applying an exchange rate of 0.90. Going forward, remuneration arrangements will be a matter for South32 and its shareholders.

(c) Employment contracts

A summary of the key terms of the employment contract and remuneration arrangements for Mr Graham Kerr in his capacity as CEO is outlined in Table 8.4 below:

Table 8.4: Graham Kerr employment contract and remuneration summary

Total fixed remuneration	<p>Mr Kerr's fixed remuneration comprises base salary and other minor benefits. Mr Kerr's base salary will be A\$1,770,000 per annum, and it includes superannuation contributions required by law.</p> <p>This base salary was set after considering remuneration levels for comparable roles in global companies of similar complexity, size, geographic footprint, listing jurisdictions, reach and industry. It reflects the CEO's responsibilities, location, qualifications and experience. This sum will be reviewed annually.</p>
Short-term incentive	<p>Mr Kerr will be eligible to participate in South32's STI arrangements. The purpose of STI is to focus Mr Kerr's efforts on those performance measures and outcomes that are priorities for South32 for the relevant financial year, and to motivate Mr Kerr to strive to achieve stretch performance objectives. They will comprise financial and non-financial measures for each year and will be set on the basis that they are expected to have a significant short-term and long-term impact on the success of South32. The measures are set at the commencement of each financial year.</p>

The target opportunity for Mr Kerr will be 120 per cent of base salary, with a maximum award of 180 per cent of base salary for stretch performance. Half of any STI will be delivered in cash at the end of the performance year, with the other half delivered in rights under the South32 Equity Incentive Plan, as outlined in Section 8.7(a). Deferral of a portion of STI awards in deferred equity over South32 Shares encourages a longer-term focus aligned to that of shareholders.

Long-term incentive	Mr Kerr will be eligible to participate in South32's LTI arrangements under the South32 Equity Incentive Plan, as outlined in Section 8.7(a), and will have a maximum LTI opportunity of up to 300 per cent of base salary on a face value basis. The purpose of the LTI is to focus Mr Kerr's efforts on the achievement of sustainable long-term value creation and success of South32 (including appropriate management of business risks). The provision of LTI awards also encourages long-term share exposure for Mr Kerr, and aligns the long-term interests of Mr Kerr and shareholders. This alignment will be demonstrated by performance being measured under the LTI over an extended time period, aligned to South32's strategy. LTI awards will be subject to a relative TSR performance condition, which must be achieved over the performance period. Relative TSR has been chosen as the most appropriate measure as it allows for an objective external assessment over a sustained period on a basis that is familiar to shareholders. Full vesting of the LTI award will only occur where South32's TSR significantly outperforms the TSR of the comparator group(s). The comparator group(s) and required outperformance for full vesting will be determined by South32 in relation to each grant. To ensure that the LTI performance conditions continue to support operational excellence, risk management and the execution of South32's strategy, the LTI award may be subject to further performance measures to supplement the relative TSR performance condition. Should this be the case, the vesting of a portion of any LTI award may instead be linked to performance against the new measure(s). South32 expects that in the event of introducing an additional performance measure(s), the weighting of the relative TSR measure would remain significant.
Contract duration	Employment will be effective on the date on which the Demerger takes effect and will continue for an indefinite term.
Cessation of employment	<p>South32 may terminate Mr Kerr's employment by giving six months' notice of termination. Mr Kerr may terminate by giving six months' notice. South32 has discretion to make payment in lieu of notice in either circumstance.</p> <p>South32 may terminate without notice in certain circumstances, including serious misconduct and conduct which adversely affects the reputation of South32.</p> <p>Mr Kerr may terminate without notice within two months of a fundamental change that materially diminishes his status, duties, authority, reporting lines or terms and conditions of his employment (other than in circumstances agreed with South32) and will receive payment in lieu of six months' notice.</p> <p>The consequences for unvested incentive awards on termination of Mr Kerr's appointment will be in accordance with the South32 Equity Incentive Plan and terms of grant.</p>
Post-employment restraints	Mr Kerr will be subject to a number of post-employment restraints for a period of six months after his employment with South32 ends, including restrictions on working with South32's competitors and on soliciting South32 employees or customers.

South32 has entered into employment agreements with other members of senior management which are, in general, consistent with the arrangements that apply to the CEO (as described above), except as described below.

Mr Fraser has been asked to assume the role of President and Chief Operating Officer Africa at South32. Mr Fraser was selected because of his extensive experience in southern Africa, having worked in the BHP Billiton Group's coal, aluminium and manganese assets before being appointed Asset President of the Mozal aluminium smelter. He brings deep operational and functional expertise to this key leadership role. As a long term BHP Billiton employee he has participated over many years in the company's talent assessment and development program and is considered to have the skills and experiences necessary to lead this important part of South32's business. These include the operational expertise required to lead the large South African based assets, along with a relentless commitment to health and safety; a set of values fully aligned to those in the BHP Billiton Charter; and an understanding of the need to work in harmony with our local communities. Before agreeing to take this role, Mr Fraser was a member of the BHP Billiton Group Management Committee. His target remuneration for his new role in South32 has been benchmarked against similar roles in comparator companies and is approximately 23 per cent lower than his current remuneration. It is not considered appropriate to propose a permanent remuneration package for Mr Fraser that is out of step with the benchmarking data for like roles. However, it is considered appropriate to put some transitional arrangements in place that will provide an opportunity for him to bridge the gap between his current target remuneration as a member of BHP Billiton's senior executive team and his remuneration at South32 for the first three years of his employment. Those arrangements will take the form of transitional performance awards. They will comprise three tranches of performance awards valued at US\$820,000 each and which will be available to vest in August 2016, 2017

and 2018. The awards will not automatically vest and will be subject to performance conditions. Vesting can be in whole, in part or nil and will be subject to an assessment by the South32 Remuneration Committee on factors including (1) Mr Fraser's ongoing service; (2) South32's performance, including its relative TSR; and (3) Mr Fraser's personal performance. The performance assessment will be conducted by the South32 Remuneration Committee and the outcomes will be reported in the South32 Remuneration Report.

8.3 SHAREHOLDINGS AND INTERESTS OF SOUTH32 DIRECTORS, SENIOR MANAGEMENT AND OTHER SPECIFIED PERSONS

All South32 Shares are currently held by BHP Billiton Limited. Therefore, no shares of South32 are held by the South32 Directors or senior management of South32.

The South32 Directors and senior management of South32 hold the following shares, or right to shares, in BHP Billiton as at 14 March 2015. Where applicable, the information includes shares held in the name of a spouse, superannuation fund, nominee and/or other controlled entities:

Table 8.5: South32 Directors and senior management – BHP Billiton shareholding (and indirect holding in South32)

Name	BHP Billiton Shares – Limited		BHP Billiton Shares – Plc	
Directors				
David Crawford		33,127		6,000
Graham Kerr		94,661		–
Keith Rumble		–		20,680
Xolani Mkhwanazi ^(a)		–		28,854
			Rights – Limited (subject to service and/or performance conditions)	Rights – Plc (subject to service and/or performance conditions)
	BHP Billiton Shares – Limited	BHP Billiton Shares – Plc		
Senior management				
Graham Kerr	94,661	–	285,306	–
Brendan Harris	18,925	216	27,187	164
Ricus Grimbeek	–	89,821	–	49,450
Mike Fraser	–	172,696	132,931	45
Nicole Duncan	8,429	754	17,217	–

(a) Xolani Mkhwanazi holds 79,067 BHP Billiton Plc rights.

Immediately following the Demerger, the South32 Directors and senior management of South32 will hold the following South32 Shares, or rights to South32 Shares:

Table 8.6: South32 Directors and senior management – South32 shareholding following the Demerger

Name	South32 Shares
Directors	
David Crawford	39,127
Graham Kerr ^(a)	94,661
Keith Rumble	20,680
Xolani Mkhwanazi ^(a)	28,854
Senior management	
Graham Kerr ^(a)	94,661
Brendan Harris ^(a)	19,141
Ricus Grimbeek ^(a)	89,821
Mike Fraser ^(a)	172,696
Nicole Duncan ^(a)	9,183

(a) Where rights over BHP Billiton Shares are being cancelled and replaced with equivalent rights over South32 Shares (as described in Table 8.8), the number of rights over South32 Shares granted to affected participants will be determined taking into account the value of the rights over BHP Billiton Shares being cancelled, with the replacement rights over South32 Shares having equivalent value. In assessing the relative value of the rights, the five-day VWAPs of BHP Billiton and South32 Shares following South32's listing on the ASX will be taken into account.

No South32 Director currently has any interests (beneficial or non-beneficial) in the share capital of South32. Except as set out above, no South32 Director holds an interest in any other securities of South32.

8.4 CONFLICTS OF INTEREST

In respect of any South32 Director (listed in Section 8.1) or member of South32's senior management (listed in Section 8.2), except as set out in Section 8, there are no actual or potential conflicts of interests between their duties to South32 and the private interests and/or other duties they may also have. In particular, none of the South32 Directors or members of South32's senior management:

- holds or has any interest in any South32 assets (other than any indirect interests as a holder of BHP Billiton Shares);
- has acquired, disposed or leased any South32 asset;
- has or had any interest in any transaction which is or was unusual in its nature or conditions or significant to the business which was effected by any member of the South32 Group during the current or immediately preceding financial year, or which was effected during an earlier financial year and remains in any respect outstanding or unperformed;
- has or had a beneficial interest in any contract to which any member of the South32 Group was a party during the current or immediately preceding financial year; or
- was selected to be a South32 Director pursuant to any arrangement or understanding with any major customer, supplier or other person having a business connection with the South32 Group (with the exception of BHP Billiton).

None of the South32 Directors, officers, promoters or major shareholders or their families had any interest, direct or indirect, in any transaction during the last two financial years or in any proposed transaction which has affected or will materially affect South32 or its investment interests or subsidiaries (except to the extent set out in this document).

8.5 CONFIRMATIONS

Each person who will be a director of South32 at the ASX Listing Date has submitted duly completed directors' declarations. The South32 Directors and members of its senior management do not have any information to declare pursuant to JSE Listing Rules 7.B.2(f) to (m).

In particular, as at the date of this document, no South32 Director or senior manager has:

- been convicted in relation to offences involving dishonesty, fraud, theft, misrepresentation, forgery, perjury or embezzlement;
- been associated with any bankruptcy, receivership, voluntary compromise arrangement, insolvency or liquidation acting in their personal capacity or the capacity of a director with an executive function within the company or other officer (other than in the provision of professional services to companies in such circumstances);
- been subject to any public criticism and/or sanctions by any statutory or regulatory authorities (including designated professional bodies); or
- been disqualified by a court from acting as a director of a company or from acting in the management or conduct of the affairs of any company.

In addition, there are no family relationships between any of the South32 Directors or members of the administrative, management and/or supervisory bodies of South32.

No fees have been paid by South32 or accrued to a third party in lieu of director's fees.

There will not be any variation in the remuneration receivable by South32 Directors as a consequence of the Demerger.

No amount has been paid or agreed to be paid by South32 within the three years preceding the date of this document, directly or indirectly, to any South32 Director to induce them to accept a directorship or to qualify them as a director or otherwise for the rendering of services by them in connection with the promotion or formation of South32 (except as disclosed in Section 8.1 and 8.2).

8.6 BUSINESS ADDRESS

The current business address of all South32 Directors and senior management is Level 32 Brookfield Place, 125 St Georges Terrace, Perth, WA, 6000, Australia, and it is proposed that following implementation of the Demerger the principal business address will be Level 35, 108 St Georges Terrace, Perth, WA, 6000, Australia.

8.7 EQUITY INCENTIVE PLANS

(a) South32 Equity Incentive Plan

South32 intends to establish an equity plan (**South32 Equity Incentive Plan**) to facilitate the grant of South32 equity awards to employees. The purpose of these awards will be to assist in the motivation, retention and reward of employees, and to further align the interests of employees with the interests of South32 Shareholders by linking a portion of remuneration to South32's ongoing success.

The rules of the South32 Equity Incentive Plan will be broad enough to cover all awards of equity granted as remuneration (including incentives) to employees, with the flexibility for the South32 Board to determine the specific conditions that will apply to each award at the time of grant. While the rules of the South32 Equity

Incentive Plan will set up default treatments that will apply in certain circumstances (for example cessation of employment), the South32 Board will have the ability to apply different treatments for a particular award. This will enable the terms of awards under the South32 Equity Incentive Plan to be tailored based on the participant group and the nature and purpose of the award.

The rules of the South32 Equity Incentive Plan and the specific conditions that are intended to apply to the short-term and long-term arrangements under the initial terms of grant are set out in Table 8.7 below:

Table 8.7: South32 Equity Incentive Plan summary

Grant of awards	<p>South32 will be able to grant awards under the South32 Equity Incentive Plan in the form of nil-cost or market-priced options over fully paid ordinary shares, or rights to receive fully paid ordinary shares or fully paid ordinary shares (collectively referred to as awards). Any grant of awards to the CEO under the South32 Equity Incentive Plan will be subject to approval by shareholders at South32's Annual General Meeting.</p> <p>This gives South32 broad flexibility to select the most appropriate equity instrument to effectively incentivise employees, which may vary depending on the seniority of the executive, the jurisdiction in which they are issued, or prevailing market and regulatory conditions.</p> <p>Upon vesting of awards, participants will receive fully paid ordinary shares in South32. The South32 Board can decide whether to purchase shares on-market or issue new shares in order to satisfy vesting. The South32 Board will also have the discretion to settle awards in cash rather than equity, but only in circumstances where this is considered appropriate by the South32 Board.</p> <p>The transitional awards, and initial awards under the STI and LTI, will be granted in the form of rights.</p>
Eligibility to participate	<p>Grants may be made at the South32 Board's discretion to employees of South32 or its related bodies corporate or any other person the South32 Board determines to be eligible to receive a grant.</p>
Vesting conditions	<p>The South32 Board will determine the vesting conditions applying to awards at the time of grant. These can be service-based or performance-based vesting conditions (or a combination of both, as will be the case for LTI awards in respect of the CEO). Again, this provides flexibility for the South32 Board to tailor the conditions according to the nature of the award, the relevant participants and to reflect market practice as it evolves.</p> <p>Any rights that remain unvested at the end of the applicable performance, service or holding period will lapse immediately.</p>
Price	<p>As awards under the South32 Equity Incentive Plan constitute part of participants' remuneration, generally no payment is required by the participant for the grant of an award (unless the South32 Board determines otherwise).</p>
Malus/clawback	<p>The South32 Board will have a broad discretion to reduce or clawback awards in certain circumstances to ensure that no inappropriate benefit is obtained by the participant. The South32 Board's discretion will apply to vested and unvested awards, including shares allocated or cash paid in connection with vested awards.</p> <p>The circumstances in which the South32 Board's discretion is intended to apply include:</p> <ul style="list-style-type: none"> • in relation to the personal performance of a participant, including for any fraud and/or misconduct; • in relation to the performance of the division or function in which the participant is employed or for which they have accountability, or which is relevant in relation to the participant's role; • in relation to the performance of South32; • where a participant's award vests or may vest as a result of the fraud or misconduct of another person, and would not have otherwise vested; • where South32 becomes aware of a material misstatement or omission in the financial statements of a South32 Group company or the South32 Group; • where South32 is required or entitled by law or South32 policy to reclaim remuneration from a participant; or • where any circumstances occur or any other factor exists (relating to such other different consideration or criteria) that the South32 Board determines in good faith to have resulted in an inappropriate benefit to the participant. <p>In addition, the South32 Board will have discretion to determine that a participant's awards will lapse notwithstanding that any performance hurdles have been met, if the Board considers that vesting the award is not justified.</p>

Corporate action or capital reorganisation	If there is a corporate action or capital reorganisation of South32 (including bonus issues and rights issues), the South32 Board may make appropriate adjustments to the terms of awards to ensure there is no material advantage or disadvantage to the participant.
Restrictions on dealing	Participants must not sell, transfer, encumber, hedge or otherwise deal with awards. Participants will be free to deal with the shares allocated on vesting of awards, subject to South32's Securities Dealing Policy and any other restrictions imposed by the South32 Board at its discretion as a condition of the award.
Cessation of employment	The provisions of the South32 Equity Incentive Plan will give the South32 Board the discretion to determine the treatment of a participant's awards on cessation of their employment, including that they will lapse, vest or cease to be subject to restrictions. The relevant treatment on cessation of employment can be set at the time of grant. For the CEO and other senior management, award terms under the STI and LTI will provide that: <ul style="list-style-type: none"> • where a participant resigns or is terminated for cause, their awards will lapse; • if a participant ceases employment due to death, serious injury, disability or illness that prohibits continued employment, or total and permanent disablement, all of their unvested awards will immediately vest; • if the participant ceases employment in any other circumstances then under the STI the rights will remain on foot (subject to a South32 Board discretion to forfeit some or all of the awards) and under the LTI a pro rata portion of the unvested awards will remain on foot and subject to the original performance hurdles, and will vest or lapse in the ordinary course (subject to a South32 Board discretion to determine that some or all of a participant's awards will lapse or vest with effect from the date the participant ceases employment, or such other date the South32 Board determines). The South32 Board retains the discretion to lapse a participant's unvested award after they have been permitted to continue holding them where a change in circumstance means it is no longer appropriate for the participant to retain their unvested award.
Change of control	In the circumstance of a change of control the award terms for the CEO and other members of senior management will not allow for the early vesting of equity awards without reference to the performance conditions under which grants were made. In the case of awards made under the STI plan in relation to the assessment of past performance and for which vesting has been deferred, those awards will vest in full. In the case of grants made under the LTI plan, the South32 Board will have the discretion to assess performance against the published performance conditions at the time of the change of control and, if satisfied, can exercise its discretion to vest awards to the extent represented by that performance. The number of awards that will vest will also be pro rated to reflect the period of time from the commencement of the performance period to the date of the change of control. Those awards that do not vest will lapse. Awards may also lapse or be cancelled if the South32 Board determines in its absolute discretion that a term of the change of control is that holders of those awards will participate in an acceptable alternative employee share incentive scheme which is reasonably acceptable to the South32 Board. If an actual change of control occurs before the South32 Board has exercised this LTI discretion, a pro rata portion of awards equal to the portion of the relevant performance period that has elapsed and tested against the performance hurdle up to the actual date of the change of control will immediately vest. For other employees, the South32 Board has the discretion under the South32 Equity Incentive Plan rules to determine that some or all awards will vest or cease to be subject to restrictions where there is likely to be a change in the control of South32. However, the South32 Board may choose to specify the treatment of awards on change of control in the terms of grant, and if it does so, then typically: <ul style="list-style-type: none"> • under the STI, all rights will vest in the event of a likely change of control; and • under the LTI, the South32 Board will retain the discretion to accelerate vesting of some or all rights if there is a likely change of control, and the balance will lapse (if the change of control occurs before the South32 Board has exercised its discretion, a pro rata portion of rights will immediately vest, and the South32 Board will decide whether the balance should vest or lapse).
Dividends and voting rights	Awards granted under the STI and LTI do not carry dividends or voting rights prior to vesting. However, the South32 Board may determine that a grant of awards will include an entitlement to a dividend equivalent payment in respect of awards that vest.
Minimum shareholding requirement	The CEO and other members of senior management will be expected to grow their holdings to the minimum shareholding requirement from the scheduled vesting of their awards over time.

(b) All employee share plan for South32

South32 intends to establish an employee share plan to provide employees with an opportunity to receive fully paid ordinary shares in South32, which will assist in aligning their interests with those of South32 Shareholders. South32 is considering the most appropriate structure for this plan and details regarding the plan will be made publicly available once these have been determined.

(c) Treatment of BHP Billiton awards for transferring employees

BHP Billiton currently operates STI and LTI programs, under which employees may receive cash and/or rights to receive BHP Billiton Shares subject to meeting defined performance and/or service conditions.

For members of the BHP Billiton Group Management Committee (**GMC**), these awards are delivered under the Short Term Incentive Plan (**STIP**), which replaced the Group Incentive Scheme (**GIS**) from FY2014 onwards, the Long Term Incentive Plan (**LTIP**), or provided as Transitional GMC awards. For other employees, these awards are delivered under the Management Award Plan (**MAP**) and the Group Short Term Incentive Plan (**GSTIP**).

BHP Billiton also operates an all-employee share plan (**Shareplus**), through which employees contribute funds after tax to purchase shares. If employees satisfy an employment condition and hold their purchased shares for a specified length of time, they receive an allocation of Matched Shares at the end of that period.

The BHP Billiton Board and BHP Billiton Remuneration Committee have given careful consideration as to how the Demerger will affect employees who currently participate in these plans. The BHP Billiton Board considers it important that any changes to these plans as a result of the Demerger are fair to shareholders and at the same time ensure that employees continue to be appropriately treated.

The treatment of the unvested awards for current participants in the BHP Billiton employee plans who will be employed within South32 if the Demerger proceeds is described below.

Table 8.8: Treatment of the unvested awards for participants who will be part of South32 following the Demerger

Award	Scheduled vesting date	Treatment
GIS FY2013 GSTIP FY2013 MAP FY2013	August 2015	As the vesting period will have been substantially completed at the time of the Demerger, awards will vest after approval of the Demerger by BHP Billiton Shareholders. Participants will receive BHP Billiton Shares and participate in the Demerger as ordinary shareholders.
GSTIP FY2014 MAP FY2014 MAP FY2015	August 2016 August 2016 August 2017	For all employees except those transferring to senior management of South32, these awards will continue on foot (except to the extent taxation obligations arise on Demerger, in which case sufficient awards may be vested to fund those obligations), however the relevant vesting conditions will be modified so that they relate to service with South32 from the date of the Demerger. In addition, the number of awards will be adjusted to reflect the dilution in value of BHP Billiton after South32 is demerged. The new number of awards will be the number of awards held before the Demerger multiplied by ((the BHP Billiton five-day VWAP plus South32 five-day VWAP) divided by BHP Billiton five-day VWAP). Prices will be based on the first five trading days following South32's listing on the ASX, subject to any adjustment that the BHP Billiton Board considers appropriate in the event that the relevant five-day VWAP is reasonably determined by the BHP Billiton Board to have been distorted by an unforeseen temporary market event unrelated to either BHP Billiton or South32. For employees transferring to senior management, these awards will be cancelled and replaced with awards of equivalent value in South32 with similar terms, including the service period and vesting date.
LTI FY2013 LTI FY2014 Transitional GMC FY2013 Transitional GMC FY2014	August 2017 August 2018 August 2015 August 2016 August 2016 August 2017	These awards (which only relate to employees transferring to senior management) will be cancelled and replaced with awards of equivalent value in South32 with similar terms, including service and performance conditions. Performance conditions will relate to BHP Billiton up to the date of the Demerger, and to South32 from the Demerger onwards.

Award	Scheduled vesting date	Treatment
Shareplus	April 2016 April 2017	<p>Holders of Acquired Shares (being shares purchased under Shareplus by or on behalf of a participant using their own funds in accordance with the rules of that plan) will participate in the Demerger as ordinary shareholders.</p> <p>Participants who meet the requirements under the rules of Shareplus are awarded one share for each Acquired Share that they hold. These are referred to as Matched Shares.</p> <p>Matched Shares that participants have accrued in respect of their Acquired Shares will vest after approval of the Demerger by BHP Billiton Shareholders. Participants will receive BHP Billiton Shares and participate in the Demerger as ordinary shareholders.</p>
LTI FY2015 STI FY2014 GSTIP FY2014 MAP FY2015		<p>For reasons of practicality and proximity to the Demerger, these awards (which would normally have been granted in late 2014, under the same terms and conditions which applied for LTI FY2015, STI FY2014, GSTIP FY2014 and MAP FY2015 grants made to other participants) were withheld for executives transferring to senior management roles with South32. Substitute awards of equivalent value in South32 with similar terms, including service and performance conditions, will be provided by South32 to affected participants.</p>

8.8 CORPORATE GOVERNANCE

Set out below is a summary of the main corporate governance policies and practices to be adopted by South32. Details of South32's key policies and practices and the charters for the South32 Board and each of its committees will be made available on the South32 website in due course.

The South32 Board plays a key role in overseeing the policies, performance and strategies of South32. It will be accountable to South32's members as a whole and must act in the best interests of South32. The South32 Board seeks to ensure that South32 is properly managed to protect and enhance members' interests, and that South32, its directors, officers and employees operate in an appropriate environment of corporate governance. Accordingly, the South32 Board will adopt a framework for managing South32, including adopting relevant internal controls, risk management processes and corporate governance policies and practices which it believes are appropriate for South32's business and which are designed to promote the responsible management and conduct of South32.

South32 will apply for a listing of the South32 Shares on the ASX. The ASX Corporate Governance Council has developed and released its ASX Corporate Governance Principles and Recommendations 3rd Edition (**ASX Recommendations**) for Australian-listed entities in order to promote investor confidence and to assist companies in meeting stakeholder expectations. The ASX Recommendations are not prescriptions, but rather guidelines designed to produce an outcome that is effective and of high quality and integrity. Under the ASX Listing Rules, South32 will be required to provide a statement in its annual report, or the URL of the page on its website where such a statement is located, disclosing the extent to which it has followed the ASX Recommendations during each reporting period. Where South32 does not follow a recommendation, it must identify the recommendation that has not been followed and give reasons for not following it.

South32 aims to comply with all of the ASX Recommendations from the time of its listing.

(a) The South32 Board

As recommended by the ASX Recommendations, the new South32 Board will comprise a majority of Independent Non-executive Directors. The South32 Board composition also reflects South32's interests in, and focus on, South Africa.

Details of the South32 Directors to be appointed to the South32 Board prior to the ASX Listing Date are set out in Section 8.1. South32 intends to appoint additional Non-executive Directors in time. Each South32 Director who has been appointed as a director of South32 as at 16 March 2015 has consented in writing to act as a director of South32 and has signed a letter of appointment to that effect.

(b) Board Charter

The Board Charter is a statement of the practices and processes the South32 Board will adopt to discharge its responsibilities. It will include the processes the South32 Board will implement to undertake its own tasks and activities, the matters it reserves for its own consideration and decision-making, and the authority it delegates to the CEO. It will provide guidance on the way in which the CEO can execute that authority and the relationship between the South32 Board and the CEO. The Board Charter also specifies the role of the Chairman, the membership of the South32 Board and the role and conduct of Non-executive Directors.

(c) Board committees

To assist the South32 Board in exercising its authority, the Board will establish the following committees:

- Risk and Audit Committee;
- Remuneration Committee;
- Sustainability Committee;
- Nomination and Governance Committee.

Board committee membership will be restricted to Non-executive Directors of South32. Each committee will have terms of reference that set out the roles, responsibilities, composition and processes of each committee. These terms of reference will be available on the South32 website in due course.

The intended roles and responsibilities of each of these committees are set out below:

(1) Risk and Audit Committee

The role of the Risk and Audit Committee will be to assist the South32 Board in monitoring the decisions and actions of the CEO and the South32 Group and to gain assurance that progress is being made towards South32's corporate objectives within the limits imposed by the South32 Board.

The Committee will assist the South32 Board in overseeing the:

- integrity of South32's financial statements;
- appointment, remuneration, qualifications, independence and performance of the external auditor and the integrity of the audit process as a whole;
- effectiveness of the systems of internal controls and risk management;
- plans, performance, objectivity and leadership of the internal audit function and the integrity of the internal audit process as a whole;
- South32 Group's systems for compliance with applicable legal and regulatory requirements within the Risk and Audit Committee's area of responsibility.

(2) Remuneration Committee

The role of the Remuneration Committee will be to assist the South32 Board in overseeing the remuneration policy, its specific application to the CEO, the CEO's direct reports and Non-executive Directors, and its general application to all employees.

The Committee will also be responsible for:

- overseeing the adoption of South32's incentive schemes;
- evaluating the performance of the CEO by giving guidance to the South32 Chairman;
- determining of levels of reward for the CEO and approval of reward to the CEO's direct reports;
- overseeing South32's compliance with applicable legal and regulatory requirements associated with remuneration matters;
- preparing the remuneration report for inclusion in South32's annual report;
- communicating the remuneration policy (and any proposed changes to the policy) to shareholders.

(3) Sustainability Committee

The role of the Sustainability Committee will be to assist the South32 Board to take reasonable steps in overseeing the:

- adequacy of the South32 Group's HSEC framework and management system;
- South32 Group's compliance with applicable legal and regulatory requirements associated with HSEC matters;
- preparation of any annual sustainability report;
- performance, resourcing and leadership of HSEC matters;
- South32 Group's performance in relation to HSEC matters, including any HSEC component of senior management incentive awards.

(4) Nomination and Governance Committee

The role of the Nomination and Governance Committee will be to assist in ensuring the South32 Board comprises individuals who are best able to discharge the responsibilities of a director, having regard to the highest standards of governance, the strategic direction of South32 and the diversity aspirations of the South32 Board.

The Committee will also be responsible for assisting the South32 Board in its consideration of:

- the South32 Board succession planning process, including the succession planning process for the Chairman and the CEO and the identification of suitable candidates for appointment to the South32 Board;
- board and director performance evaluation;
- the provision of appropriate training and development opportunities for directors;
- the South32 Group's corporate governance practices;
- the independence and time requirement for Non-executive Directors.

(d) Corporate governance policies

The South32 Board will adopt the following corporate governance policies, each prepared having regard to the ASX Recommendations and which will be made available on South32's website.

(1) Market Disclosure and Communications Policy

South32 is committed to promoting high standards of disclosure to ensure that trading in South32 Shares occurs in an efficient and well-informed market and it is aware of the obligations it will have under the Corporations Act and ASX Listing Rules in particular.

To safeguard the effective dissemination of information and to ensure that directors and employees are aware of their obligations, South32 will adopt a Market Disclosure and Communications Policy that outlines how South32 intends to comply with the continuous disclosure obligations imposed by law, including how South32 identifies and distributes information to shareholders and market participants in a timely manner.

Information will be communicated to South32 Shareholders through lodgement with the ASX and the other exchanges on which South32 Shares are quoted, and announcements will be made available on South32's website.

(2) Securities Dealing Policy

South32 will adopt a Securities Dealing Policy to explain the regulations applying to dealings in securities and to establish best practice procedures for buying and selling securities.

The Securities Dealing Policy will apply to all employees, and to directors, members of senior management and other nominated employees of South32 and its related bodies corporate and their connected persons (**Relevant Persons**). The policy will provide that employees and Relevant Persons must not deal in South32 securities when they are in possession of unpublished price-sensitive information, and the Relevant Persons must not deal on a short term trading basis, nor during designated prohibited periods (except in exceptional circumstances).

Otherwise, trading will only be permitted by:

- directors (other than the Chairman of the South32 Board) and the CEO with prior written approval from the Chairman of the South32 Board;
- the Chairman of the South32 Board with prior written approval from the South32 Board or the Chair of the Risk and Audit Committee;
- members of senior management (other than the CEO) and nominated employees with prior written approval of the CEO.

(3) Code of Business Conduct

South32 is committed to a high level of integrity and ethical standards in all business practices. For this purpose, South32 will adopt a Code of Business Conduct that will apply to all employees, contractors and officers engaged by South32 entities across all jurisdictions.

The Code of Business Conduct will specify the responsibilities of employees, contractors and officers to:

- act in the best interests of South32;
- act honestly and with high standards of personal integrity;
- comply with applicable laws and regulations;
- not knowingly participate in any illegal or unethical activity;
- not enter into any arrangement or participate in any activity that would conflict with South32's best interests or that would be likely to negatively affect South32's reputation;
- not take advantage of the property or information of South32 or its customers for personal gain or cause detriment to South32 or its customers;
- not take advantage of their position, or the opportunities arising from it, for personal gain.

A breach of those principles or requirements is regarded as serious misconduct which may lead to disciplinary action, including termination.

Approval and reporting requirements will apply in relation to the receipt of gifts, hospitality and entertainment. The Code will also be supported by other procedures adopted by South32, including in relation to competition law and anti-corruption.

Business conduct investigations and the management of queries and concerns will be undertaken and recorded in accordance with defined processes supporting the Code to prevent, detect and respond correctly to business conduct incidents.

(4) Diversity and Inclusion Policy

The South32 Board will adopt a Diversity and Inclusion Policy in order to facilitate a diverse and representative workforce, particularly in management and leadership, and to address the representation of employees from diverse backgrounds in senior management positions and on the Board. South32's aspiration is to have a workforce that best represents the communities in which the South32 Businesses are located and where South32 employees live.

At a South32 Board and senior management level, gender and ethnicity have been identified as key areas of focus for South32. Accordingly, the primary focus of the Diversity and Inclusion Policy will be achieving, over a reasonable transition period, adequate representation of women and employees from diverse ethnic backgrounds in senior management positions and on the South32 Board.

Each year, the South32 Board will set measurable objectives with a view to progressing towards a balanced gender representation at a board and senior management level, and may also consider setting measurable objectives relevant to ensuring other forms of diversity at a board and senior management level. The South32 Board will report to shareholders annually, including in relation to South32's progress towards achieving these measurable objectives.

(5) Communications strategy

South32 aims to ensure that South32 Shareholders are kept informed of all major developments affecting the state of South32's affairs. In addition to South32's continuous disclosure obligations, South32 recognises that potential investors and other market participants may wish to obtain information about South32 from time to time. South32 intends to communicate this information regularly through a range of forums and publications.

Copies of announcements lodged with the exchanges on which South32 Shares are quoted, including investor briefings, half-yearly financial statements, annual reports and notices of meetings and explanatory notes will be available on South32's website. It is intended that the website will also contain a facility for South32 Shareholders to direct queries to South32.

This page has been intentionally left blank.

9 SELECTED HISTORICAL COMBINED FINANCIAL INFORMATION

9.1 OVERVIEW

The following is a summary of South32's historical combined financial information for the periods indicated. The data has been extracted from, and is qualified in its entirety by reference to, the historical combined financial information in Annexures 1 and 2, except for the non-IFRS measures, which are explained in Section 3.5. The summary should be read in conjunction with the information in those sections and with Section 5 and Section 11. Investors are advised to read the whole of this document and not rely on just the key or summarised information.

The historical combined financial information for the six months ended 31 December 2014 (H1 FY2015) and the six months ended 31 December 2013 (H1 FY2014), which has been extracted from the historical combined financial information of South32 set out in Annexure 2, and for the twelve months ended 30 June 2014 (FY2014), the twelve months ended 30 June 2013 (FY2013) and the twelve months ended 30 June 2012 (FY2012), which has been extracted from the historical combined financial information of South32 set out in Annexure 1 (**Reporting Periods** and each a **Reporting Period**) has been prepared by aggregating historical financial information relating to the businesses that will be held by South32 at the date of Demerger including assets, liabilities and transactions directly attributable to South32. No pro forma adjustments have been applied to this historical combined financial information.

The historical combined financial information has been prepared with the objective of presenting the results, net assets and cash flows of South32 for the Reporting Periods. The entities which comprise South32 have been under common management and control of BHP Billiton throughout the Reporting Periods covered in the historical combined financial information. Consequently, this historical combined financial information may not necessarily be indicative of the financial performance that would have been achieved if South32 had operated as an independent entity for the Reporting Periods, nor may it be indicative of the results of operations of South32 for any future period.

The historical combined financial information for South32 has been prepared specifically for the purpose of this document and, except for the departures from the financial reporting requirements and/or UKLA Prospectus Rules and JSE Listing Rules as noted in the 'Basis of preparation of historical combined financial information' section to the historical combined financial information in Section 1.6 of Annexure 1, in order to comply with Sections 8.1 to 8.13 of the JSE Listing Rules and the applicable UKLA Listing Rules and Prospectus Directive.

IFRS does not provide for the preparation of combined financial information, and accordingly in preparing the historical combined financial information certain accounting conventions commonly used for the preparation of historical financial information as described in the Annexure to SIR 2000 (Investment Reporting Standard applicable to public reporting engagements on historical financial information) issued by the United Kingdom Auditing Practices Board have been applied. The application of these conventions results in certain departures from IFRS (as described more fully in the 'Basis of preparation of historical combined financial information' section to the historical combined financial information in Section 1.6 of Annexure 1).

9.2 SUMMARY OF SOUTH32'S HISTORICAL COMBINED FINANCIAL INFORMATION

Table 9.1: Summary of South32's historical combined financial information

US\$M, unless otherwise stated	6 months ended December		12 months ended June		
	H1 FY2015	H1 FY2014	FY2014	FY2013	FY2012
Combined income statement					
Revenue	5,040	5,348	10,444	12,093	13,835
Profit/(loss) from operations	1,251	554	774	(963)	2,060
Profit/(loss) attributable to members of South32	688	317	132	(1,467)	1,401
Earnings/(loss) per ordinary share (basic) (US cents)	12.92	5.95	2.48	(27.55)	26.31
Earnings/(loss) per ordinary share (diluted) (US cents)	12.88	5.94	2.47	(27.46)	26.20
Combined balance sheet					
Total assets	26,723	19,683	19,690	19,543	24,012
Total liabilities	9,176	9,394	9,870	9,423	10,200
Invested capital attributable to members of South32 ^(c)	16,710	9,396	8,953	9,213	13,010
Other financial information					
Underlying EBITDA ^(a)	1,306	976	2,055	2,118	2,831
Underlying EBIT ^(a)	800	510	1,070	1,154	1,926
Underlying Earnings ^{(a),(b)}	534	369	614	755	1,258
Net operating assets	11,460	11,412	11,290	11,409	13,641
Capital expenditure	411	394	769	1,139	2,013
Net operating cash flows	1,249	493	1,670	1,426	2,393
Summary financial ratios					
Underlying EBIT margin	16.6%	10.5%	11.3%	10.5%	16.0%
Margin on third party products	7.4%	3.6%	2.3%	3.8%	4.0%

(a) Refer to Section 3.5 of this document for the definition of Underlying Earnings, Underlying EBIT and Underlying EBITDA.

(b) Refer to Section 11.3 of this document for the calculation of Underlying Earnings.

(c) During H1 FY2015 there was an issue of shares to BHP Billiton Limited of US\$8 billion to enable the acquisition of the companies that will comprise South32. The proceeds were primarily placed on deposit with BHP Billiton.

Contingent liabilities and commitments at 30 June 2014, 2013 and 2012 are set out in note 18 Contingent liabilities and note 19 Commitments of Annexure 1, respectively.

9.3 CAPITALISATION AND INDEBTEDNESS STATEMENT

The following tables show the South32 Group's combined capitalisation and indebtedness.

The information presented in Section 9.3 is not representative of South32's net indebtedness on a standalone basis following implementation of the Demerger. In particular, the 'Unguaranteed/Unsecured' non-current debt in Table 9.2 and 'Other non-current loans' in Table 9.3 primarily comprise BHP Billiton intercompany arrangements that will be settled prior to implementation of the Demerger (without issuance of new equity to third parties). Refer to Section 10.7 for a pro forma summary of South32's net indebtedness.

(a) Capitalisation and indebtedness

The financial information relating to the South32 Group as at 31 December 2014 in the following table has been extracted from the historical combined financial information set out in Annexure 2 and sets out the capitalisation and indebtedness of the South32 Group as at 31 December 2014:

Table 9.2: Capitalisation and indebtedness summary

US\$M	As at 31 December 2014
Current debt	
– Secured ^(a)	13
– Unguaranteed/Unsecured ^(b)	123
Total current debt	136
Non-current debt (excluding current portion of long-term debt)	
– Secured ^(a)	682
– Unguaranteed/Unsecured ^(b)	3,923
Total non-current debt	4,605
Invested capital	
– Invested capital attributable to members of South32 ^(c)	16,710
– Invested capital attributable to non-controlling interests	837
Total invested capital	17,547

(a) Secured debt comprises finance leases of US\$695 million.

(b) Represents bank overdraft, short-term borrowings and other unsecured loans; primarily comprises intercompany arrangements with BHP Billiton that will be settled prior to the implementation of the Demerger.

(c) Invested capital attributable to members of South32 comprises share capital of South32 of US\$8,651 million and reserves and retained earnings of US\$8,059 million.

The following adjustments to the capitalisation and indebtedness information set out above will take place as part of implementation of the Demerger:

- The settlement of net intercompany balances with BHP Billiton through the issue of South32 equity and cash settlements;
- South32 will undertake a share division so that the number of South32 Shares immediately before implementation of the Demerger is equal to the number of BHP Billiton Limited Shares on issue;
- BHP Billiton Plc will be issued with a number of South32 Shares so that it will hold a number of South32 Shares equal to the number of BHP Billiton Plc Shares on issue as at the Plc Record Date (or a subsidiary of BHP Billiton Plc will be issued with those South32 Shares and on-transfer them to BHP Billiton Plc), with each South32 Share being issued at the VWAP of South32 Shares traded on the ASX over the five trading days from the ASX Listing Date;
- BHP Billiton Limited will subscribe for one South32 Share for cash consideration, and separately South32 may return capital to BHP Billiton Limited, in such amounts as are required for South32 to arrive at the post-Demerger targeted net cash balance for South32 described in Section 14.4.

(b) Net indebtedness

The financial information relating to the South32 Group as at 31 December 2014 in the following table has been extracted from the historical combined financial information set out in Annexure 2 and sets out the net indebtedness of the South32 Group as at 31 December 2014:

Table 9.3: Net indebtedness summary

US\$M	31 December 2014
Cash ^(a)	(426)
Cash equivalents	(7)
Liquidity	(433)
Current bank debt	121
Other current financial debt ^{(b)(c)}	15
Current financial debt	136
Net current financial indebtedness	(297)
Other non-current loans ^(c)	4,605
Non-current financial indebtedness	4,605
Net financial indebtedness^{(d)(e)}	4,308

(a) Excludes US\$26 million cash that is restricted by legal or contractual arrangements.

(b) Other current financial debt includes finance leases and unsecured other borrowings.

(c) Includes finance leases of US\$695 million.

(d) Net financial indebtedness does not include the fair value of South32's derivatives.

(e) Excludes receivables from related parties.

10 SUMMARY OF PRO FORMA HISTORICAL FINANCIAL INFORMATION

10.1 OVERVIEW

Section 10, Annexure 3 and Annexure 4 contain pro forma historical financial information of South32 (**South32 pro forma historical financial information**) including:

- South32 summary pro forma historical consolidated income statements for H1 FY2015 and FY2014;
- South32 summary pro forma historical consolidated cash flow statements before financing activities and tax and after capital expenditure for H1 FY2015 and FY2014;
- South32 pro forma historical consolidated balance sheet as at 31 December 2014.

References to South32 pro forma historical financial information are references to the pro forma historical consolidated financial information of South32 during the relevant period or at the relevant time, being the businesses that are being transferred and restructured to form South32, which is proposed to be demerged to BHP Billiton Shareholders. Reference to South32 pro forma historical financial information refers to South32 on a consolidated basis.

The South32 pro forma historical financial information in Section 10 is presented in an abbreviated form and does not contain all the disclosures required by IFRS or the Corporations Act.

The Independent Accountant has prepared an Independent Accountant's Assurance Report in respect of the South32 pro forma historical financial information, a copy of which is included in Section 12. The comments made in relation to the scope and limitations in this report should be noted.

Section 10 should also be read in conjunction with the risks to which South32 is subject as set out in Section 2. All amounts disclosed in tables are expressed in millions of US dollars and, unless otherwise noted, are rounded to the nearest million US dollars.

10.2 BASIS OF PREPARATION

The South32 pro forma historical financial information has been prepared and is intended for illustrative purposes only and addresses a hypothetical situation and therefore does not purport to reflect the actual financial performance or the actual financial position that South32 would have obtained if South32 had operated as a standalone entity for the periods presented. Further, the information is not necessarily indicative of the results South32 expects in future periods, for reasons including:

- South32 did not operate independently of BHP Billiton during the periods for which South32 pro forma historical financial information is presented;
- South32 pro forma historical financial information includes allocations to South32 of certain corporate expenses incurred by BHP Billiton and directly attributable to South32;
- South32 pro forma historical financial information may not reflect the strategies or operations that South32 may have followed or undertaken had it acted as a standalone entity rather than as part of the BHP Billiton Group;
- the financing arrangements under which South32 operated during the periods presented do not reflect the anticipated financing arrangements of South32 following the Demerger;
- the application of tax laws in relation to the assets and operations of South32 under BHP Billiton ownership may not reflect the application of tax laws to South32. This will include the tax consequences of tax elections that may be made by South32, including, but not limited to, the formation and operation of South32's own Australian tax consolidated group. Taxation expense reflects the tax charges recorded in the underlying income statements of South32 which have been affected by the tax sharing arrangements within BHP Billiton and are not necessarily representative of the tax charges that would have been reported had South32 been an independent group throughout the relevant periods;
- South32 may have been exposed to different risks had it operated as a standalone entity rather than as part of BHP Billiton.

The South32 pro forma historical financial information which is the responsibility of the South32 Directors has been derived from, and should be read in conjunction with, the historical combined financial information of South32 contained in Annexures 1 and 2.

South32's pro forma historical financial information has been prepared in accordance with:

- the recognition and measurement principles prescribed in IFRS, except that these standards do not provide for the preparation or reporting of pro forma financial information;
- accounting policies including the basis of preparation adopted by South32 as set out in note 1 Accounting policies to the historical combined financial information in Annexures 1 and 2;
- items 1 to 6 of Annex II of the Commission Regulation 809/2004/EC (the UK Prospectus Directive Regulation).

The summary pro forma historical consolidated income statements and consolidated cash flow statements have been prepared on the basis that South32 moved to joint control of the Manganese Business and the impact of the Demerger (including adjustments to reflect the reversal of intercompany net financing costs and dividends), as if they had occurred at 1 July 2013. Historically, financial results of the Manganese Business have been included on a consolidated basis with recognition of a non-controlling interest. In contemplation of the Demerger, BHP Billiton and Anglo American Plc agreed to make certain changes to the agreement that governs their interests in the Manganese Business. For accounting purposes, BHP Billiton and Anglo American Plc are taken to share joint control of the Manganese Business from 2 March 2015. South32 has discontinued consolidation of the Manganese Business and accounts for its equity interest as an equity accounted joint venture.

No pro forma adjustments have been made to South32's pro forma historical consolidated income statements or cash flow statements to reflect the anticipated additional corporate overhead costs or savings of South32 operating as a standalone entity (refer to Section 11.2(d)), as compared to the corporate costs while South32 formed part of the BHP Billiton Group in accordance with the Commission of the European Communities' Commission Regulation 809/2004/EC Prospectus Directives regulations in the United Kingdom for the preparation of pro forma financial statements. Discussion of these additional corporate overhead costs is contained in Section 11.2(d) (as footnote (a) to Table 11.7).

The pro forma historical consolidated cash flow statements in Section 10 have been presented to net operating cash flows before financing activities and tax and after capital expenditure, as following the Demerger, South32's cash flows could be significantly altered due to a different tax and financing profile as a result of South32 operating on a standalone basis.

The South32 pro forma historical consolidated balance sheet has been prepared on the basis that the Demerger was effected and completed on 31 December 2014 and that the South32 assets and liabilities have been transferred from BHP Billiton to South32 at their historical book value on a consolidated basis with pro forma adjustments made to reflect:

- the move to joint control of the Manganese Business referred to above as if it had occurred on 31 December 2014;
- settlement of intercompany balances between South32 and BHP Billiton through the issue of South32 Shares to South32 Shareholders in conjunction with cash settlements;
- tax adjustments that reflect the exit of relevant South32 entities from the BHP Billiton tax consolidated groups on preparation for and implementation of the Demerger and subsequent formation of the South32 tax consolidated group; and
- Demerger set up costs to be incurred by South32 after the Demerger takes effect.

10.3 SOUTH32 SUMMARY PRO FORMA HISTORICAL CONSOLIDATED INCOME STATEMENTS

The South32 summary pro forma historical consolidated income statements for H1 FY2015 and FY2014 are as follows:

Table 10.1: South32 summary pro forma historical consolidated income statements

US\$M	H1 FY2015	FY2014
Revenue	4,089	8,344
Other income	150	269
Expenses excluding net finance costs	(3,550)	(8,338)
Share of operating profit of equity accounted investments ^(a)	35	62
Profit from operations	724	337
Net finance costs	5	(187)
Taxation expense	(423)	(47)
Profit after taxation	306	103
Basic earnings per share (US cents) ^(b)	5.75	1.93
Other financial information		
Profit from operations	724	337
Earnings adjustments ^(c) to derive Underlying EBIT	(76)	323
Underlying EBIT^(c)	648	660
Depreciation and amortisation	417	823
Underlying EBITDA^(c)	1,065	1,483
Profit after taxation	306	103
Earnings adjustments after taxation	136	343
Underlying Earnings^(c)	442	446
Underlying basic earnings per share (US cents) ^(b)	8.30	8.38

(a) The share of operating profit of equity accounted investments includes the Manganese Business operations which were previously consolidated.

(b) The number of shares used for the purpose of calculating earnings per share is 5,324 million.

(c) Underlying Earnings, Underlying EBIT and Underlying EBITDA are defined in Section 3.5.

See Section 3.2 of Annexure 3 for the reconciliation of the pro forma adjustments made to the South32 pro forma historical consolidated income statement.

10.4 SOUTH32 SUMMARY PRO FORMA HISTORICAL CONSOLIDATED CASH FLOW STATEMENTS BEFORE FINANCING ACTIVITIES AND TAX AND AFTER CAPITAL EXPENDITURE

The South32 summary pro forma historical consolidated cash flow statements before financing activities and tax and after capital expenditure for H1 FY2015 and FY2014 are as follows:

Table 10.2: South32 summary pro forma historical consolidated cash flow statements before financing activities and tax and after capital expenditure

US\$M	H1 FY2015	FY2014
Profit from operations	724	337
Other non-cash items	445	1,129
Profit from equity accounted investments	(35)	(62)
Change in working capital	(205)	15
Cash generated from operations	929	1,419
Dividends received (including equity accounted investments)	131	206
Capital expenditure	(317)	(590)
Net operating cash flows before financing activities and tax and after capital expenditure	743	1,035

See Section 3.4 of Annexure 3 for the reconciliation of the pro forma adjustments made to the South32 pro forma historical cash flow statements.

Following the Demerger, South32, operating as a standalone entity, will incur additional ongoing corporate and financing costs and benefit from savings from the implementation of the regional organisational model (refer to Section 11.2(d)). Adjustments have not been made to reflect the impacts of these items and the impacts of financing costs and taxation across the historical periods presented as South32's corporate and operating structure, financing facilities, tax arrangements and capital structure following the Demerger may be significantly different to the arrangements in place during the periods presented.

10.5 SOUTH32 PRO FORMA HISTORICAL CONSOLIDATED BALANCE SHEET

The following table sets out South32's pro forma historical consolidated balance sheet as at 31 December 2014. For the purpose of presenting the pro forma historical consolidated balance sheet, it has been assumed that the Demerger was effected and completed on 31 December 2014.

Table 10.3: South32 pro forma historical consolidated balance sheet

US\$M	Change of control in Manganese Business						South32 Pro forma 31 December 2014
	South32 combined balance sheet 31 December 2014 ^(a)	Removal of consolidated balances ^(b)	Equity accounted interest ^(c)	Inter-company settlement and debt draw down ^(d)	South32 set up costs ^(e)	Tax consolidation ^(f)	
ASSETS							
Current assets							
Cash and cash equivalents	459	(43)	–	59	(111)	–	364
Trade and other receivables	1,098	(139)	–	–	–	–	959
Receivable from BHP Billiton	9,508	(295)	–	(9,213)	–	–	–
Receivable from related party	–	–	60	–	–	–	60
Other financial assets	15	–	–	–	–	–	15
Inventories	1,406	(382)	–	–	–	–	1,024
Current tax assets	107	–	–	–	–	–	107
Other	37	(11)	–	–	–	–	26
Total current assets	12,630	(870)	60	(9,154)	(111)	–	2,555
Non-current assets							
Trade and other receivables	185	(4)	–	–	–	–	181
Receivables from related party	–	–	240	–	–	–	240
Other financial assets	508	(158)	–	–	–	–	350
Investments accounted for using the equity method	13	–	3,027	–	–	–	3,040
Inventories	60	–	–	–	–	–	60
Property, plant and equipment	12,220	(1,907)	–	18	22	–	10,353
Intangible assets	290	(74)	–	90	–	–	306
Deferred tax assets	801	(43)	–	–	–	(174)	584
Other	16	–	–	–	–	–	16
Total non-current assets	14,093	(2,186)	3,267	108	22	(174)	15,130
Total assets	26,723	(3,056)	3,327	(9,046)	(89)	(174)	17,685

US\$M	Change of control in Manganese Business						South32 Pro forma 31 December 2014
	South32 combined balance sheet 31 December 2014 ^(a)	Removal of consolidated balances ^(b)	Equity accounted interest ^(c)	Inter-company settlement and debt draw down ^(d)	South32 set up costs ^(e)	Tax consolidation ^(f)	
LIABILITIES							
Current liabilities							
Trade and other payables	1,232	(228)	-	-	-	-	1,004
Payable to BHP Billiton	41	(2)	-	(39)	-	-	-
Interest bearing liabilities	136	(4)	-	150	-	-	282
Other financial liabilities	6	-	-	-	-	-	6
Current tax payables	104	(30)	-	-	(23)	28	79
Provisions	413	(52)	-	-	-	-	361
Deferred income	4	(1)	-	-	-	-	3
Total current liabilities	1,936	(317)	-	111	(23)	28	1,735
Non-current liabilities							
Trade and other payables	34	-	-	-	-	-	34
Interest bearing liabilities	877	(135)	-	-	-	-	742
Interest bearing liabilities payable to BHP Billiton	3,728	-	-	(3,728)	-	-	-
Other financial liabilities	18	-	-	-	-	-	18
Deferred tax liabilities	569	(26)	-	-	-	127	670
Provisions	2,010	(478)	-	-	-	-	1,532
Deferred income	4	-	-	-	-	-	4
Total non-current liabilities	7,240	(639)	-	(3,728)	-	127	3,000
Total liabilities	9,176	(956)	-	(3,617)	(23)	155	4,735
Net assets	17,547	(2,100)	3,327	(5,429)	(66)	(329)	12,950
INVESTED CAPITAL							
Invested capital attributable to members of South32	16,710	(1,263)	3,327	(5,429)	(66)	(329)	12,950
Invested capital attributable to non-controlling interests	837	(837)	-	-	-	-	-
Total invested capital	17,547	(2,100)	3,327	(5,429)	(66)	(329)	12,950

(a) South32's historical combined balance sheet has been extracted, without material adjustment from the historical combined financial information in Annexure 2 (refer to discussion in Section 10.8(a) for transfer of assets and liabilities at existing book value).

(b) Pro forma adjustment has been made to reflect the loss of control and subsequent de-consolidation of the Manganese Business assuming the changes to the joint venture agreement were effective 31 December 2014. This information has been extracted, without material adjustment from the underlying accounting records of South32.

- (c) This adjustment represents the fair value of the equity accounted investment in the Manganese Business as at 2 March 2015 the date the change of control became effective and as disclosed in note 10 Subsequent events of Annexure 2.
- (d) This adjustment represents the settlement of net intercompany balances sourced from the South32 historical combined balance sheet (less the Manganese Business), the transfer of property, plant and equipment of US\$18 million and intangible assets of US\$90 million relating to the capital spend incurred by BHP Billiton on information technology infrastructure and corporate facilities for South32. The settlement of net intercompany receivables with BHP Billiton of US\$5,446 million (current receivables of US\$9,213 million, current payables of US\$39 million and non-current interest bearing liabilities payable of US\$3,728 million) will be by a return of South32 capital of US\$5,429 million and cash settlements. The cash settlement amount of US\$59 million is calculated to provide South32 with a target net cash and interest bearing liabilities position and assumes an indicative drawdown of US\$150 million from available debt facilities.
- (e) The adjustment made to cash reflects South32 set up costs associated with the Demerger to be incurred by South32 after the Demerger. These totals primarily include information technology set up costs and relocation costs as well as costs incurred under transitional service arrangements but exclude debt establishment fees.
- (f) As a consequence of the Demerger, South32 is required by Australian tax legislation to exit BHP Billiton's existing Australian tax consolidated groups and re-consolidate in its own, new Australian tax consolidated group. As a result, certain deferred tax assets will reduce due to the resetting of the tax bases of certain tangible and intangible assets. It is expected that there will be a step down in the South32 cost base for income tax and/or capital gains tax of US\$1,460 million that results in a reduction in South32's deferred tax assets of US\$174 million, a deferred tax liability of US\$127 million and a current tax liability of US\$28 million. The pro forma adjustment is based on the South32 Directors' best estimate of the value of tax cost bases at the effective date of the tax consolidation. Refer to Section 10.8(e) for more details.

10.6 DEBT FACILITIES

Prior to the Demerger, the South32 Group was funded by a combination of internal cash flows, working capital facilities and intercompany loans provided by BHP Billiton which have been funded by a combination of cash and short and long-term debt.

If the Demerger proceeds, ongoing funding for the South32 Businesses is expected to be provided in the same way, a combination of cash generated by the South32 Businesses, working capital facilities and intercompany loans provided by South32 which may be funded by a combination of cash, short and long-term debt and equity market raisings.

As at the date of this document, a new multicurrency revolving syndicated loan facility (**Facility**) has been executed by all parties and the Facility is committed subject to various conditions being satisfied, including those summarised below.

At the time the Demerger is implemented, South32 will have access to the Facility which may be used to fund its opening cash position.

The Facility contains market standard terms and conditions for a facility agreement of this nature. The key terms of the Facility are as follows:

Table 10.4: Facility summary

Facility type	Multicurrency revolving syndicated facility.	
Currencies	US dollar or optional currencies, including Australian dollar and Euro.	
Commitments and maturities	Commitment US\$1.5 billion	Maturity date Five years after the date of the agreement plus two one-year extension options for those lenders which agree to extend.
Applicable interest rates	Base rate plus a margin which has been agreed at current commercial rates. The applicable base rates include: <ul style="list-style-type: none"> LIBOR for a loan in US dollars; BBSW for a loan in Australian dollars; EURIBOR for a loan in Euros. 	
Conditions precedent to initial drawdown	The Facility contains conditions precedent to initial drawdown that are customary for a facility of this nature and other conditions precedent which relate to the implementation of the Demerger and listing of South32 on the ASX.	
Events of default	The Facility contains customary events of default including, but not limited to, payment default, breach of representation, breach of financial covenant and cross-default.	
Mandatory prepayment and cancellation events	The Facility includes customary mandatory prepayment and cancellation events, including a change of control provision which in certain circumstances allows a lender to cancel its commitments under the Facility and require full prepayment of amounts outstanding under the Facility.	
Covenants	The Facility contains a single financial covenant and undertakings which are customary for a facility of this nature including, but not limited to, provision of information, negative pledge and restrictions on subsidiary indebtedness and disposals of assets.	
Security	None.	
Guarantee	Each borrower under the agreement is a guarantor in respect of the obligation of each other borrower which is a subsidiary of it.	

10.7 PRO FORMA NET INDEBTEDNESS SUMMARY

The following table sets out South32's pro forma historical summary of net indebtedness as at 31 December 2014 extracted from the South32 pro forma historical consolidated balance sheet set out in Section 10.5. For the purpose of presenting this information, it has been assumed that the Demerger was effected and completed on 31 December 2014.

Table 10.5: Pro forma net indebtedness summary

US\$M	31 December 2014
Cash ^(a)	(343)
Cash equivalents	(7)
Liquidity^(b)	(350)
Current bank debt	271
Other current financial debt ^{(c)(d)}	11
Current financial debt	282
Net current financial indebtedness	(68)
Non-current loans ^(d)	742
Non-current financial indebtedness	742
Net financial indebtedness^{(e)(f)}	674

(a) Excludes US\$14 million cash that is restricted by legal or contractual arrangements.

(b) Liquidity includes cash and cash equivalents. It does not include undrawn amounts under available facilities.

(c) Other current financial debt includes finance leases and unsecured other borrowings.

(d) Includes total finance leases of US\$680 million.

(e) Net financial indebtedness does not include the fair value of South32's derivatives.

(f) Excludes receivables from related parties.

10.8 ACCOUNTING JUDGEMENTS AND ESTIMATES

The preparation of South32's financial information requires management to make estimates and judgements that affect the reported amounts of assets and liabilities and the reported revenue and expenses during the periods presented therein. On an ongoing basis, management evaluates its estimates and judgements in relation to assets, liabilities, contingent liabilities, revenue and expenses. Management bases its estimates and judgements on historical experience and on various other factors it believes to be reasonable under the circumstances, the results of which form the basis of making judgements about the carrying values of assets and liabilities that are not readily apparent from other sources. Actual results may differ from these estimates under different assumptions and conditions.

In accordance with IFRS, South32 is required to include information regarding the nature of the estimates and judgements and potential impacts on its financial results or financial position in the financial information. This information can be found in note 1 Accounting policies to the historical combined financial information in Annexure 1.

The most important of these estimates and judgements are set out in the following subsections:

(a) Accounting for internal restructure

During FY2015, the Internal Restructure took place in preparation for the listing of South32. This resulted in South32 Limited (formerly BHP Coal Holdings Pty Limited) becoming the legal parent of the South32 Group. The South32 Directors elected to account for the restructure at pre-existing book values. In the South32 Directors' judgement, the continuation of the existing accounting values is consistent with the accounting that would have occurred if the assets and liabilities had already been in a structure suitable to list and most appropriately reflects the substance of the Internal Restructure. As such, the historical combined financial information of South32 has been presented as a continuation of the pre-existing accounting values of assets and liabilities in BHP Billiton's financial statements. In adopting this approach the South32 Directors note that there is an alternate view under which such a restructure is accounted for at fair value. An IASB project on accounting for common control transactions is likely to address such restructures in the future. However, the precise nature of any new requirements and the timing of these are uncertain.

(b) Equity accounted investment in Manganese Business

In contemplation of the Demerger, BHP Billiton and Anglo American Plc agreed on 19 August 2014 (subject to receiving necessary regulatory approvals which were obtained on 2 March 2015) to make certain changes to the agreement which governs their interest in the Manganese Business. As a result of these changes, BHP Billiton will discontinue consolidation of the Manganese Business and account for its equity interest as an equity accounted joint venture. This will result in the equity accounted investment being remeasured at fair value of approximately US\$3 billion. This value is significantly higher than the historical book value and accordingly increases the potential risk of impairment in the future. The determination of fair value, and so recoverable amount of the investment, requires significant judgement and relies on future estimates.

(c) Closure and rehabilitation provisions

Closure planning is a key consideration in the planning and development of South32's projects and operations. Operations are required to maintain closure plans, which describe the proposed methods to rehabilitate and remediate following resource development and also address closure obligations. The closure plans provide the basis for estimating the closure costs and the associated accounting for closure and rehabilitation provisions.

Mining, extraction and processing activities normally give rise to obligations for site closure or rehabilitation. In accordance with South32's accounting policies, provisions have been created for all known closure and rehabilitation liabilities at the time that environmental disturbance occurs. When the extent of the disturbance increases over the life of an operation, the provision is increased accordingly. Closure and rehabilitation provisions are measured at the expected value of future cash flows, discounted to their present value and determined according to the probability of alternative estimates of cash flows occurring for each operation. Discount rates used are specific to the country in which the operation is located. Significant judgements and estimates are involved in forming expectations of future activities and the amount and timing of the associated cash flows.

There can be no assurance that new information or regulatory requirements with respect to known sites or the identification of new remedial obligations at other sites will not require additional future provisions for remediation and such provisions could be material. In addition to the uncertainties noted above, certain closure and rehabilitation activities are subject to legal disputes and depending on the ultimate resolution of these issues, the final liability for these matters could vary.

The following table sets out South32's pro forma closure and rehabilitation provisions as at 31 December 2014, which have been adjusted for the de-consolidation of the Manganese Business.

Table 10.6: South32 pro forma closure and rehabilitation provision overview^(a)

US\$M	31 December 2014
Open mines	85
Closed mines	45
Current	130
Open mines	1,119
Closed mines	293
Non-current	1,412
Total	1,542

(a) Refer to Sections 2.4(b) and 2.5(a)(2) for more details on closure provisions.

(d) Pro forma contingent liabilities

In the normal course of business, contingent liabilities may arise from general legal proceedings, from guarantees or from closure and rehabilitation obligations connected with current or former sites. Where South32 considers that potential liabilities have a low probability of crystallising or it is not possible to quantify them reliably, they are disclosed as contingent liabilities. These are not provided for in the historical combined financial information but are disclosed in the notes to the historical combined financial information as follows:

Table 10.7: Pro forma contingent liabilities at balance date, not otherwise provided for in the pro forma historical consolidated balance sheet, are categorised as arising from:

US\$M	31 December 2014 ^(a)	Pro forma adjustments ^{(b)(c)}	31 December 2014 pro forma
Associates and joint ventures			
Bank guarantees	–	4	4
Actual or potential litigation ^(d)	–	44	44
Other	–	15	15
Total associates and joint ventures	–	63	63
Subsidiaries and joint operations			
Bank guarantees	6	(6)	–
Actual or potential litigation ^(d)	653	(72)	581
Other	26	35	61
Total subsidiaries and joint operations	685	(43)	642
Total contingent liabilities	685	20	705

(a) South32's contingent liabilities have been extracted, without material adjustment from the historical combined financial information in Annexure 2 note 9 contingent liabilities.

(b) A pro forma adjustment has been made to reflect the loss of control and subsequent de-consolidation of the Manganese Business assuming the changes to the shareholder agreement were effective 31 December 2014. This column reverses the full amount of the Manganese Businesses contingent liabilities under the heading 'Subsidiaries and joint operations' and brings in South32's equity share under the heading 'Associates and joint ventures'. This information has been extracted, without material adjustment from the underlying accounting records of South32.

(c) An adjustment is made to include potential liability that may arise from the Internal Restructure in preparation for the Demerger.

(d) Actual or potential litigation amounts relate to a number of actions against South32 associates and joint ventures and subsidiaries and joint operations, some of which relate to commercially confidential information, and where South32 has assessed that the liability is not probable South32 has not provided for such amounts in the pro forma historical consolidated balance sheet. South32 is indemnified by BHP Billiton for certain of the above contingent liabilities that are subject to actual or potential litigation. The actual or potential litigation relates primarily to numerous tax assessments or matters arising from tax audits relating to transactions in prior years in Brazil, Colombia and South Africa. Additionally, there are a number of legal claims or potential claims against South32, its subsidiaries or joint operations the outcome of which cannot be foreseen at present, and for which no amounts have been included in the table above.

(e) Tax consolidated group

Following the Demerger, South32 will form a new Australian tax consolidated group. Certain deferred tax balances will increase or decrease as the South32 Businesses exit the tax consolidated groups existing under BHP Billiton and tax cost bases of certain tangible and intangible assets are reset upon formation of the South32 tax consolidated group. It is expected that there will be a step down in the South32 tax cost base for income tax and/or capital gains tax purposes of US\$1,460 million that results in a corresponding reduction in South32's deferred tax asset of US\$174 million, a deferred tax liability of US\$127 million and a current tax liability of US\$28 million. These impacts are estimates and may vary subject to measurement of the tax cost bases when this is finalised post Demerger. The extent to which deferred tax balances must be recognised upon the tax consolidation of South32 will depend on a number of factors and assumptions, including the actual market value of South32 at the date of the tax consolidation.

10.9 TAXATION

Certain South32 Businesses operating in Australia currently pay tax as part of BHP Billiton's group taxation arrangements. As a standalone entity, the effective tax rate of South32 may vary from what it would have been if South32 remained part of BHP Billiton.

South32 Businesses operate in a number of countries with differing tax rates. For the 12 months to 30 June 2014, 68 per cent of the pro forma Underlying EBIT from operations of South32 was derived from Australia (standard current corporate tax rate of 30 per cent) and 20 per cent from South Africa (standard current corporate tax rate of 28 per cent). The remainder of South32's Underlying EBIT was derived from other countries with various tax rates.

11 OPERATING AND FINANCIAL REVIEW AND PROSPECTS

11.1 INTRODUCTION

The following operating and financial review is intended to convey the South32 Directors' perspective on South32's operating performance and its financial condition. The South32 Directors intend this disclosure to assist readers in understanding and interpreting the historical combined financial information set out in Annexures 1 and 2 and summarised in Section 9, which include the South32's historical combined financial information for FY2014, FY2013 and FY2012 and historical combined financial information for H1 FY2015 and H1 FY2014, respectively.

The basis of preparation of the historical combined financial information is set out in the 'Basis of preparation of historical combined financial information' in note 1 Accounting policies in Annexures 1 and 2.

Investors should read Section 11 in conjunction with the risk factors in Section 2, South32 Business descriptions in Section 7 and the historical combined financial information set out in Section 9 and Annexures 1 and 2 and the other information included in this document, and should not rely solely on key or summarised information.

South32 uses a number of non-IFRS financial measures in addition to those reported in accordance with IFRS. The South32 Directors believe that these non-IFRS measures, as set out in Section 3.5, are important when assessing the underlying financial and operating performance of South32 and each of the South32 Businesses set out in Section 7.1.

(a) Overall financial performance

South32 uses several financial measures to monitor the financial performance of its business. The two key measures are Underlying Earnings for South32 as a whole and Underlying EBIT for the performance of the individual South32 Businesses.

Table 11.1: Summary historical combined financial information

US\$M except where stated	6 months ended December		12 months ended June		
	H1 FY2015	H1 FY2014	FY2014	FY2013	FY2012
Combined income statement					
Revenue	5,040	5,348	10,444	12,093	13,835
Profit/(loss) from operations	1,251	554	774	(963)	2,060
Attributable profit/(loss)	688	317	132	(1,467)	1,401
Basic earnings/(loss) per share (US cents)	12.92	5.95	2.48	(27.55)	26.31
Other financial measures					
Net operating cash flows	1,249	493	1,670	1,426	2,393
Underlying EBITDA	1,306	976	2,055	2,118	2,831
Underlying EBITDA margin	27.5%	20.7%	22.1%	19.7%	23.8%
Underlying EBIT	800	510	1,070	1,154	1,926
Underlying EBIT margin	16.6%	10.5%	11.3%	10.5%	16.0%
Underlying Earnings	534	369	614	755	1,258

(b) Production

A summary of South32's actual production volumes for H1 FY2015, H1 FY2014, FY2014, FY2013 and FY2012 is shown below. Further details are set out in Section 7.

Table 11.2: Summary of South32's actual production volumes

	6 months ended December		12 months ended June		
	H1 FY2015	H1 FY2014	FY2014	FY2013	FY2012
Alumina (kt)					
Worsley Alumina	1,953	1,970	3,916	3,675	2,917
Brazil Aluminium	680	633	1,262	1,205	1,235
Aluminium (kt)					
South Africa Aluminium ^(a)	356	415	804	761	719
Mozal Aluminium	135	134	266	264	264
Brazil Aluminium	26	63	104	154	170
Energy coal (kt)					
South Africa Energy Coal ^(b)	16,525	14,973	30,384	31,627	33,279
Illawarra Metallurgical Coal	880	741	1,539	1,278	1,305
Metallurgical coal (kt)					
Illawarra Metallurgical Coal	3,858	2,614	5,974	6,664	6,621
Manganese ore (kt)					
Australia Manganese	2,499	2,438	4,776	5,027	4,306
South Africa Manganese ^(c)	2,056	1,808	3,526	3,490	3,625
Manganese alloy (kt)					
Australia Manganese	139	123	269	234	198
South Africa Manganese ^{(c)(d)}	233	180	377	374	404
Nickel (kt)					
Cerro Matoso	21	24	44	51	49
Lead (kt)					
Cannington	99	94	187	213	239
Zinc (kt)					
Cannington	37	32	58	56	55
Silver (koz)					
Cannington	12,235	12,667	25,161	31,062	34,208

(a) Aluminium smelting at Bayside ceased with the closure of the final potline in June 2014.

(b) Shown on 100 per cent basis. South32's interest in saleable production is 90 per cent.

(c) Shown on 100 per cent basis. South32's interest in saleable production is 60 per cent except production of ore at Hotazel Mines, South Africa where South32's interest is 44.4 per cent.

(d) Production includes MCFeMn.

11.2 EXTERNAL FACTORS AND TRENDS AFFECTING SOUTH32'S RESULTS

Section 11.2 describes some of the external factors and trends that have had a material impact on South32's financial condition and results of operations. Details of South32's risk factors can be found in Section 2 and in note 23 Financial risk management to the historical combined financial information contained in Annexure 1.

Management monitors particular trends arising from external factors with a view to managing the potential impact on South32's future financial condition and results of operations.

(a) Commodity prices

The prices South32 obtains for its products is a key driver of its business, and fluctuations in these commodity prices affect its results, including cash flows and asset values. The estimated impact on Underlying EBIT for FY2014 of changes to commodity prices is set out below:

Table 11.3: Commodity price sensitivity summary

Estimated impact on FY2014 Underlying EBIT of change of:	US\$M
US\$5/t on alumina price	26
US\$20/t on aluminium price	24
US\$1/t on metallurgical coal price	6
US\$1/t on energy coal price	15
US¢5/dmtu on manganese ore price	19
US\$10/t on manganese alloy price	7
US\$150/t on nickel price	7
US\$20/t on lead price	4
US\$20/t on zinc price	1
US¢20/oz on silver price	5

The following table shows prices of South32's most significant commodities for H1 FY2015, H1 FY2014, FY2014, FY2013 and FY2012. These prices represent quoted prices from the relevant sources as indicated. These prices differ from the realised prices on the sale of South32's production due to contracts to which South32 is a party, differences in quotational periods, quality of products, delivery terms and the range of quoted prices that are used for contracting sales in different markets.

Table 11.4: Quoted commodity prices

	6 months ended December		12 months ended June		
	H1 FY2015	H1 FY2014	FY2014	FY2013	FY2012
Alumina^(a) (US\$/t)					
Average	338	320	321	327	334
Closing	355	333	312	318	305
Aluminium (LME cash) (US\$/t)					
Average	1,975	1,774	1,764	1,938	2,168
Closing	1,831	1,765	1,851	1,731	1,835
Metallurgical coal^(b) (US\$/t)					
Average	110	141	128	159	239
Closing	110	132	111	130	222
Energy coal^(c) (US\$/t)					
Average	68.00	78.01	77.48	84.66	105.56
Closing	65.13	85.05	73.88	74.18	87.71
Manganese ore^(d) (US\$/dmton)					
Average	4.34	5.21	4.95	5.29	4.90
Closing	4.32	5.08	4.20	5.54	5.06
Manganese alloy^(e) (US\$/t)					
Average	940	1,000	1,020	1,106	1,177
Closing	873	1,027	999	1,038	1,160
Nickel (LME cash) (US\$/t)					
Average	17,218	13,911	15,168	16,380	19,335
Closing	14,925	13,977	18,717	13,691	16,469
Silver^(f) (US\$/oz)					
Average	18.14	21.07	20.57	28.97	33.26
Closing	15.97	19.50	20.87	18.86	27.08
Lead^(g) (US\$/t)					
Average	2,091	2,107	2,104	2,134	2,128
Closing	1,853	2,206	2,129	2,058	1,796
Zinc^(h) (US\$/t)					
Average	2,273	1,884	1,967	1,928	2,019
Closing	2,167	2,085	2,205	1,823	1,843

(a) Platts PAX FOB Australia – market price assessment of calcined metallurgical/smelter grade alumina.

(b) Platts Low-Vol Hard Coking Coal Index FOB Australia – representative of high-quality hard coking coals.

(c) RBCT FOB (API 4).

(d) Metal Bulletin manganese ore 44 per cent Mn China, except for FY2012 which was CRU CIF China import 43 per cent contained manganese.

(e) Bulk FerroAlloy HCFMn Western Europe DDP.

(f) Daily LBMA Silver Fixing Prices.

(g) Lead Settlement Daily Official US dollars per tonne monthly average.

(h) Zinc Settlement LME Daily Official US dollars per tonne monthly average.

The following summarises the pricing trends of South32's most significant commodities for H1 FY2015, FY2014 and FY2013 and significant trends.

During FY2014, commodity markets saw some support from a modest improvement in global economic activity, though economic growth was uneven across different regions. The United States and Japan saw underlying momentum increase, but emerging economies, notably China, saw economic growth slow.

During FY2013, commodity markets were impacted by a slower pace of economic growth in China that was balanced in part by increased stability in European sovereign debt markets and an improved private sector performance in the United States. The metals commodities attracted lower prices than the previous year as a result of supply growing faster than demand.

(1) Alumina

The Platts FOB Australia average alumina price increased by six per cent over the first half of FY2015 compared to the first half of FY2014. The alumina market was supported by strong Chinese demand, ramp-ups of newly commissioned smelters in Northwest China, and the ban on bauxite ore exports from Indonesia.

The Platts FOB Australia average price decreased by two per cent during FY2014. Although demand grew, driven by the commissioning of new smelters in China, increasing supply outpaced the growth in demand.

The Platts FOB Australia average alumina price decreased by two per cent during FY2013, with price support coming from increasing demand and supply disruptions during the year. The market remained balanced, with refinery production continuing to grow in China.

(2) Aluminium

The London Metal Exchange (**LME**) average aluminium cash settlement price increased by 11 per cent in the first half of FY2015 compared to the first half of FY2014. This reflects the improved fundamentals of the market, with demand growth strengthening and supply responses to lower prices having an effect.

The LME aluminium average cash settlement price decreased by nine per cent during FY2014. Demand continued to increase, but new supply offset the curtailment of high-cost capacity. Delays in implementing changes to LME warehouse rules contributed to record high regional premiums ex-China as inventories were constrained by warehouse queues.

The LME aluminium average cash settlement price decreased by 11 per cent during FY2013. Demand growth slowed, while simultaneously new supply continued to be added, which contributed to an increasing market surplus. During this period, LME stocks reached record levels, driven by the attractiveness of warehouse financing deals to investors.

(3) Metallurgical coal

The Platts Low-Vol Hard Coking Coal Index average price for the first half of FY2015 decreased by 22 per cent compared to the first half of FY2014. The price decrease was underpinned by continuing seaborne supply growth. Demand from traditional markets remained positive, whilst Chinese seaborne demand decreased due to intense competition with domestic coking coal supply.

The average Platts Low-Vol Hard Coking Coal Index decreased by 19 per cent during FY2014. While demand from traditional markets recovered steadily, the price decrease was mainly driven by continuing supply growth from Australia. The year-end price was 13 per cent lower than the average price for the year.

The average Platts Low-Vol Hard Coking Coal Index decreased by 33 per cent during FY2013, driven by decreased growth rates of global pig iron production. Pig iron production decreased in Europe, which historically accounts for a large share of hard coking coal import demand. Supply increased during the year, particularly from Australia and Canada.

(4) Energy coal

The Richards Bay FOB average price for thermal coal for the first half of FY2015 decreased by 13 per cent compared to the first half of FY2014. The price decrease was driven by moderating demand growth with strong growth from India offset by China, coupled with healthy supply from Australia and Indonesia.

The Richards Bay Coal Terminal FOB average price decreased by eight per cent during FY2014. The decrease was driven by weaker import demand growth from India and China, coupled with supply growth from Australia, Russia and Indonesia.

The Richards Bay Coal Terminal FOB average price decreased by 20 per cent during FY2013. Seaborne demand growth was driven by China and India, where volumes reached all-time record levels. Prices decreased as Indonesian, Australian and United States exports increased simultaneously.

(5) Manganese

The Metal Bulletin manganese ore China CIF average price decreased by 17 per cent during the first half of FY2015 compared to the first half of FY2014. Demand growth slowed, while South African and Australian supply increased amidst higher Chinese inventory levels. The Western Europe spot HCFEMn average manganese alloy price decreased by six per cent during the first half of FY2015, driven by persistent oversupply and the currency depreciation of major producers in India, Australia, South Africa and Europe.

The Metal Bulletin manganese ore China CIF average price decreased by six per cent during FY2014. Demand growth slowed, while South African supply increased amid higher Chinese inventory levels. The Western Europe spot HCFeMn average alloy price decreased by eight per cent during FY2014. Weaker alloy prices led to decreased production in South Korea and the United States.

The Metal Bulletin manganese ore China CIF average price increased by eight per cent during FY2013 compared to the CRU China manganese ore average import price in FY2012. Rising ore prices in the second half of FY2013 were supported by record Chinese steel output, while supply from South Africa, Australia and Gabon increased to meet the higher demand. The Western Europe spot HCFeMn average alloy price decreased six per cent during FY2013. Declining alloy prices were driven by oversupply in a weak export market due to lower steel production in the developed economies of Europe and the United States.

(6) Nickel

The average LME nickel cash settlement price increased by 24 per cent for the first half of FY2015 compared to the first half of FY2014 as a result of the Indonesian ore export ban impacting supply. However, the price at 31 December 2014 decreased by 20 per cent from the 30 June 2014 price, as overall the market remained well supplied as evidenced by rising LME stocks.

The average LME cash settlement nickel price decreased by seven per cent during FY2014. Increased supply growth coming mainly from Chinese nickel pig iron and new production from greenfield projects was greater than demand growth in the first half of the year. The price increase in the second half of the year was driven by decreased low-cost supply due to an ore export ban imposed in Indonesia, which is one of the largest global suppliers. Demand growth increased, supported by a recovery in stainless steel production in Europe and the United States. The year-end price was 23 per cent higher than the average price for the year.

The average LME cash settlement nickel price decreased by 15 per cent during FY2013. Demand for nickel continued to grow, but at a lower rate compared with that for the previous year. The price decreased as a result of the demand growth being outpaced by increasing supply tonnages, coming mainly from Chinese nickel pig iron, as well as new production from greenfield projects.

(7) Silver

The average daily LBMA silver price for the first half of FY2015 dropped 14 per cent compared to the first half of FY2014 as demand fell through this period.

During FY2014, the average daily LBMA Silver Fixing Price decreased by 29 per cent, with monthly averages spending the year consistently above US\$19 per ounce. There was no significant imbalance in supply and demand, with price movements driven primarily by investors.

There was a general downtrend in the average daily LBMA Silver Fixing Price during FY2012 and FY2013. During FY2013, there was no significant imbalance in supply and demand; however, the average price fell by 13 per cent.

(8) Lead

The average Lead Settlement Daily Official price for the first half of FY2015 decreased by one per cent compared to the first half of FY2014 with the market remaining well supplied as the growth in consumption was met with increased supply.

The average Lead Settlement Daily Official price decreased by one per cent in FY2014. The market remained finely balanced, as shown by the lack of change in price.

The average Lead Settlement Daily Official price traded, from a monthly average high of US\$2,683 per tonne to a lower range between US\$1,800 per tonne to US\$2,200 per tonne during FY2012. This movement was driven by investor concerns regarding the state of the European economy. In FY2013, the average Lead Settlement Daily Official price was flat.

(9) Zinc

The average Zinc Settlement LME Daily Official price for the first half of FY2015 increased by 21 per cent compared to the first half of FY2014 as the refined market was in deficit with supply unable to keep up with rising demand.

In FY2014, the average Zinc Settlement LME Daily Official price increased by two per cent. The market remained balanced for the first half of FY2014. Towards the end of FY2014, the price increased on the back of modest demand, but with constrained growth in refined supply. Investor demand pushed this price further in anticipation of further tightening in supply.

In FY2013, the average Zinc Settlement LME Daily Official price decreased by five per cent. The market traded at similar levels, albeit with lower volatility and with supply and demand balanced. Day-to-day movements were dominated by macroeconomic news, investor sentiment and risk appetite rather than developments in zinc market dynamics. The average Zinc Settlement LME Daily Official price traded over a large range in FY2012, driven primarily by investor sentiment. There was some downward pressure due to consumption slowing in Europe and China.

(b) Exchange rates

South32 is exposed to exchange rate risk on foreign currency sales, purchases and expenses, as no active currency hedging is in place. Because a majority of South32's sales are denominated in US dollars, and the US dollar plays a dominant role in its business, funds borrowed and held in US dollars provide a natural hedge to currency fluctuations. Operating costs and costs of locally sourced equipment are influenced by fluctuations in local currencies, primarily the Australian dollar, South African rand, Brazilian real and Colombian peso. Foreign exchange gains and losses reflected in operating costs owing to fluctuations in the local currencies relative to the US dollar may potentially offset one another.

South32 is also exposed to exchange rate translation risk in relation to net monetary liabilities, being foreign currency denominated monetary assets and liabilities, including debt and other long-term liabilities. Historically, the majority of South32's monetary assets and liabilities were held in US dollars. Details of South32's exposure to foreign currency fluctuations are contained within note 23 Financial risk management to the historical combined financial information contained in Annexure 1.

The following table indicates the estimated impact on FY2014 Underlying EBIT of a strengthening of the US dollar against the principal currencies to which South32 is exposed.

The sensitivities below give the estimated impact on Underlying EBIT based on the exchange rate movement in isolation. The sensitivities assume all variables except for exchange rate remain constant. There is an inter-relationship between currencies and commodity prices where movements in exchange rates can cause movements in commodity prices and vice versa. This is not reflected in the sensitivities below. These sensitivities should therefore be used with care.

Table 11.5: Exchange rate sensitivity summary

Estimated impact on FY2014 Underlying EBIT of strengthening US\$ relative to:	US\$M
Australian dollar (US1 cent/A\$)	30
South African rand (0.1 rand/US\$)	15
Brazilian real (0.02 real/US\$)	3
Colombian peso (20 peso/US\$)	3
Mozambican metical (0.5 metical/US\$)	1

The following table shows the average and period end exchange rates of the most significant currencies that affect South32's results:

Table 11.6: Exchange rates

	6 months ended December		12 months ended June		
	H1 FY2015	H1 FY2014	FY2014	FY2013	FY2012
Australian dollar^(a)					
Average	0.89	0.92	0.92	1.03	1.03
Closing	0.82	0.89	0.94	0.92	1.00
Brazilian real					
Average	2.40	2.28	2.29	2.04	1.78
Closing	2.66	2.34	2.20	2.18	2.08
Colombian peso					
Average	2,037	1,910	1,935	1,814	1,825
Closing	2,392	1,927	1,881	1,923	1,807
South African rand					
Average	10.99	10.07	10.39	8.84	7.77
Closing	11.55	10.53	10.60	10.00	8.41
Mozambican metical					
Average	31.32	29.92	30.63	29.56	27.36
Closing	33.33	30.01	31.55	29.80	27.95

(a) Displayed as US\$ to A\$1 based on common convention.

The appreciation of the US dollar began at the start of H1 FY2015 and continued to strengthen against most currencies through the six-month period to end-December 2014. The most significant exchange rate movements and depreciation were in the Colombian peso, the Brazilian real and the Australian dollar in order of the absolute change from the spot at the beginning of H1 FY2015 and the spot rate at the end of H1 FY2015. The South African rand also weakened against the US dollar, but experienced slightly less currency depreciation. The significant movements in exchange rates reflected the relative change in market sentiment towards a stronger recovery in the US economy, and the expectations around the timing of the US Federal Reserve Bank raising interest rates in 2015, against the rising uncertainty in growth prospects in other economies.

In FY2014, the South African rand weakened throughout the year owing to the impact from disruptive labour action across many sectors of the economy amidst sluggish global economic growth, a widening trade deficit and the SARB raising interest rates to offset inflationary pressure. The end of the financial year coincided with the end of a five-month strike at platinum mines that had seen a rise in capital outflows amid loss in investor confidence. Overall, the Australian dollar and Colombian peso ended FY2014 stronger against the US dollar, while the Brazilian real weakened.

In FY2013, volatility in exchange rates increased compared with that in FY2012, with a strengthening of the US dollar in the last quarter of FY2013. Overall the Australian dollar, South African rand, Colombian peso and Brazilian real ended FY2013 weaker against the US dollar.

(c) Changes in product demand and supply

Global demand and supply for the commodities South32 produces is a key driver of commodity prices, and fluctuations in product demand and supply affect its results, including cash flows and asset values. Information on demand and supply trends is set out in Section 6.

(d) Operating costs

As the prices for South32's products are determined by the global commodity markets in which South32 operates, South32 does not generally have the ability to offset cost pressures through corresponding price increases. Therefore, controlling operating costs is a key driver of South32's results. Operating costs for the last three financial years and the most recent two half years are set out below:

Table 11.7: Operating costs summary^(a)

US\$M	6 months ended December		12 months ended June		
	H1 FY2015	H1 FY2014	FY2014	FY2013	FY2012
Raw materials and consumables used	1,641	1,552	3,308	3,584	3,496
Employee benefits expense	721	752	1,496	1,603	1,558
External services (including transportation)	842	993	1,837	2,438	2,734
Third party commodity purchases	394	748	1,233	1,601	2,265
Net foreign exchange (gains)/losses	(83)	(47)	(68)	(97)	(100)
Fair value change on derivatives	(5)	16	2	16	(122)
Government royalties paid and payable	138	178	348	383	413
Depreciation and amortisation expense	506	466	985	964	905
Exploration and evaluation expenditure	-	11	17	21	41
Impairment of assets	-	-	319	2,210	108
Operating lease rentals	38	46	94	97	96
Other operating expenses	121	191	419	391	441
Total expenses	4,313	4,906	9,990	13,211	11,835
Less earnings adjustments	87	33	(391)	(2,129)	114
Total expenses included in Underlying Earnings	4,400	4,939	9,599	11,082	11,949

(a) The operating costs in this table for FY2014, FY2013 and FY2012 are extracted from the historical combined financial information. The operating costs for H1 FY2015 and H1 FY2014 are from the underlying accounting records. They do not include additional costs of running South32 relative to those incurred by the South32 Businesses as part of the BHP Billiton Group before the Demerger, estimated to be US\$60 million (pre-tax) per annum. They also do not include any ongoing overhead savings from implementation of South32's regional operating model, which South32 believes will outweigh the additional costs in the near term.

During the first half of FY2015, South32 continued to focus on curtailing operating costs that form part of Underlying Earnings. This was demonstrated by a decrease in external services costs of US\$151 million and a reduction in employee benefits expense of US\$31 million compared to H1 FY2014. In addition, there was a decrease in third party commodity purchases of US\$354 million.

During FY2014, South32 focused on curtailing operating costs that form part of Underlying Earnings, demonstrated by a decrease in external services costs of US\$601 million, reduced production-related expenses of US\$276 million and a reduction in employee benefits expense of US\$107 million. In addition, there was a decrease of third party commodity purchases of US\$368 million.

Reductions in operating costs that form part of Underlying Earnings were also noted in FY2013 through a reduction in external services of US\$296 million. These savings were partly offset by an increase in production-related expenses of US\$88 million. In addition there was a decrease in third party commodity purchases of US\$664 million.

(e) Capital expenditure

Capital expenditure is disclosed for each South32 Business in Table 11.8 below (presented on a cash basis):

Table 11.8: Capital expenditure summary^(a)

US\$M	6 months ended December		12 months ended June		
	H1 FY2015	H1 FY2014	FY2014	FY2013	FY2012
Capital expenditure					
Worsley Alumina	27	22	56	154	900
South Africa Aluminium	10	7	28	17	14
Mozal Aluminium	5	3	8	7	9
Brazil Aluminium	5	7	9	6	12
<i>Alumina</i>	3	2	4	4	8
<i>Aluminium</i>	2	5	5	2	4
South Africa Energy Coal	58	22	65	133	162
Illawarra Metallurgical Coal	180	173	309	357	314
Australia Manganese	57	58	108	271	213
<i>Manganese alloy</i>	6	2	5	3	12
<i>Manganese ore</i>	51	56	103	268	201
South Africa Manganese	37	32	70	104	131
<i>Manganese Alloy</i>	9	10	17	42	58
<i>Manganese Ore</i>	28	22	53	62	73
Cerro Matoso	18	35	56	50	105
Cannington	14	30	60	39	73
Group and unallocated items	-	5	-	1	80
Total capital expenditure	411	394	769	1,139	2,013
Exploration expenditure	13	14	24	29	51
Total	424	408	793	1,168	2,064

(a) Capital expenditure is included on a cash basis and excludes capitalised interest.

Capital expenditure encompasses expenditure on investment projects and capital expenditure on sustaining and other items.

Table 11.9: Capital expenditure

US\$M	6 months ended December		12 months ended June		
	H1 FY2015	H1 FY2014	FY2014	FY2013	FY2012
Capital expenditure					
Major projects	92	156	316	561	1,192
Minor and maintenance	319	238	453	578	821
Total	411	394	769	1,139	2,013

South32's capital expenditure decreased significantly across the period from FY2012 to FY2014, reducing 62 per cent from US\$2,013 million to US\$769 million. In H1 FY2015, FY2014 and FY2013, South32 focused on reducing discretionary capital expenditure.

No major investment projects relating to the South32 Businesses were approved by BHP Billiton during the period from FY2012 through to FY2014.

(f) Interest rates

During the Reporting Period, the majority of South32's debt was raised under central BHP Billiton funding programs, and BHP Billiton has generally funded its businesses through intercompany balances. Interest rate risk for South32 has been managed as part of the portfolio risk mitigation strategy of BHP Billiton's central treasury function.

South32 was exposed to interest rate risk on its outstanding borrowings, primarily on net borrowings from BHP Billiton. Historically, interest rate exposure has been managed under BHP Billiton's policy for interest on borrowings to be on a US dollar floating interest rate basis. Deviation from this policy required the prior approval of BHP Billiton's Financial Risk Management Committee and was managed within the Cash Flow at Risk framework, which is described in note 23 Financial risk management to the historical combined financial information in Annexure 1. Interest rates on internal borrowings and receivables from BHP Billiton are generally on a floating interest rate basis.

11.3 OPERATING RESULTS – UNDERLYING EARNINGS

As discussed in Section 3.3 of Annexure 3, Underlying Earnings will be the key measure that South32 management uses internally to assess the performance of the South32 Group. Underlying Earnings is included in note 2 Segment reporting to the historical combined financial information in Annexures 1 and 2. Underlying Earnings is reconciled to profit/(loss) after taxation as set out below.

Table 11.10: Underlying Earnings

US\$M	6 months ended December		12 months ended June		
	H1 FY2015	H1 FY2014	FY2014	FY2013	FY2012
Profit/(loss) after taxation	738	358	217	(1,304)	1,433
Earnings adjustments – refer Section 11.5(d)	(204)	11	397	2,059	(175)
Underlying Earnings	534	369	614	755	1,258

11.4 CONSOLIDATED RESULTS – OVERVIEW

(a) Half year ended 31 December 2014 compared with half year ended 31 December 2013

South32's revenue in H1 FY2015 was US\$5,040 million, a decrease of US\$308 million, or six per cent, from US\$5,348 million for the corresponding period H1 FY2014. The revenue decrease can be largely attributed to Cannington (US\$119 million) and Australia Manganese (US\$111 million) with offsets at all other South32 Businesses, in particular at Worsley (US\$96 million increase in group production revenue). In addition revenue from third party products decreased by US\$372 million.

The decrease in revenue was more than offset by a decrease in operating cash costs of US\$638 million resulting in an increase in Underlying EBITDA of US\$330 million from the corresponding period.

Depreciation and amortisation in H1 FY2015 of US\$506 million was US\$40 million higher than the corresponding period in H1 FY2014. As a result, Underlying EBIT in H1 FY2015 increased by US\$290 million to US\$800 million. Despite the challenging environment, South32 achieved an Underlying EBIT margin of 16.6 per cent excluding the impact of third party sales.

South32's Underlying Earnings in H1 FY2015 were US\$534 million, an increase of 45 per cent from US\$369 million in H1 FY2014.

(b) Year ended 30 June 2014 compared with year ended 30 June 2013

South32's revenue in FY2014 was US\$10.4 billion, a decrease of US\$1.7 billion, or 14 per cent, from US\$12.1 billion in the corresponding period. The revenue decrease was across most South32 Businesses with Illawarra Metallurgical Coal (US\$409 million), Cannington (US\$286 million) and Cerro Matoso (US\$208 million) being the most significant. In addition, revenue from third party products decreased US\$401 million.

The decreases in revenue at Illawarra Metallurgical Coal and Cannington were primarily due to substantially lower realised prices, which decreased revenue by US\$263 million and US\$143 million, respectively. Lower volumes at Cerro Matoso decreased revenue by US\$93 million.

Despite the decrease in revenue of US\$1.7 billion, total operating cash costs decreased by US\$1.6 billion resulting in a decrease in Underlying EBITDA of only US\$63 million, or three per cent, to US\$2,055 million. Increases in Underlying EBITDA for South Africa Energy Coal (US\$82 million), Worsley Alumina (US\$102 million) and Brazil Aluminium (US\$83 million) were more than offset by decreases for Cannington (US\$191 million), Illawarra Metallurgical Coal (US\$167 million) and Cerro Matoso (US\$147 million).

Depreciation and amortisation in FY2014 of US\$985 million was US\$21 million higher than the prior year. As a result, Underlying EBIT in FY2014 declined by US\$84 million to US\$1,070 million, substantially in line with the fall in Underlying EBITDA. Despite the challenging environment, South32 achieved an Underlying EBIT margin of 11.3 per cent excluding the impact of third party sales.

South32's Underlying Earnings in FY2014 were US\$614 million, a decrease of 19 per cent from US\$755 million in FY2013.

Adjustments between Underlying Earnings and profit/(loss) after taxation, as set out in Section 11.5(d), were US\$397 million in FY2014, down from US\$2,059 million in FY2013.

Attributable profit in FY2014 was US\$132 million compared to a loss in FY2013 of US\$1,467 million.

South32's strong cash generating capacity was reflected in an increase in net operating cash flows to US\$1,670 million in FY2014, an increase of 17 per cent from US\$1,426 million in FY2013.

(c) Year ended 30 June 2013 compared with year ended 30 June 2012

South32's revenue in FY2013 was US\$12.1 billion, a decrease of US\$1.7 billion, or 13 per cent, from US\$13.8 billion in the corresponding period. The revenue decrease was across most South32 Businesses with South Africa Energy Coal (US\$436 million), Illawarra Metallurgical Coal (US\$414 million) and Cannington (US\$225 million) being the most significant. In addition, revenue from third party products decreased US\$696 million. The increase in production from the ramp up of an expansion project at Worsley Alumina contributed to an increase in revenue of US\$138 million.

The decrease in revenue in South Africa Energy Coal and Illawarra Metallurgical Coal were primarily due to lower realised prices of US\$366 million and US\$657 million, respectively. Lower volumes at Cannington decreased revenue by US\$138 million.

The decrease in revenue of US\$1.7 billion was partially offset by a decrease in operating cash costs of US\$1 billion, which led to a decrease in Underlying EBITDA of US\$713 million, or 25 per cent, to US\$2,118 million. Increases in Underlying EBITDA at Australia Manganese (US\$164 million), Worsley Alumina (US\$127 million) and South Africa Manganese (US\$129 million) were more than offset by decreases in Illawarra Metallurgical Coal (US\$516 million), South Africa Energy Coal (US\$301 million), Cannington (US\$242 million) and Cerro Matoso (US\$183 million).

Depreciation and amortisation in FY2013 of US\$964 million was US\$59 million higher than the prior year. As a result Underlying EBIT in FY2013 declined by US\$772 million to US\$1,154 million, primarily as a consequence of the fall in Underlying EBITDA. Despite the challenging environment, the South32 Group achieved an Underlying EBIT margin of 10.5 per cent.

South32's Underlying Earnings in FY2013 were US\$755 million, a decrease of 40 per cent from US\$1,258 million in FY2012.

Adjustments between Underlying Earnings and profit/(loss) after taxation, as set out in Section 11.5(d), were US\$2,059 million in FY2013, compared to a deduction of US\$175 million in FY2012.

Attributable profit in FY2013 was a loss of US\$1,467 million compared to a profit in FY2012 of US\$1,401 million.

Net operating cash flows of US\$1,426 million declined by 40 per cent from US\$2,393 million in FY2012.

11.5 OPERATING RESULTS

(a) Earnings movements

The following table describes the approximate impact of the principal factors that affected Underlying Earnings for H1 FY2015, FY2014 and FY2013:

Table 11.11: Reconciliation of movements in Underlying Earnings for the period

US\$M	6 months ended	12 months ended	
	December	June	
	H1 FY2015	FY2014	FY2013
Underlying Earnings reported in the prior period	369	755	1,258
Changes in Underlying EBIT			
Change in volumes	(29)	(73)	5
Change in sales prices	23	(667)	(1,354)
Price-linked costs	34	6	116
Net price impact	57	(661)	(1,238)
Operating cash costs	155	243	256
Exchange rates	170	602	334
Inflation on costs	(98)	(229)	(228)
Non-cash costs	(10)	13	86
Change in costs	217	629	448
Other	45	21	13
Total changes in Underlying EBIT	290	(84)	(772)
Net finance costs	(38)	(79)	(15)
Taxation expense	(87)	22	284
Underlying Earnings	534	614	755

The method of calculation of the factors that affected Underlying Earnings and the financial statement line items of revenue, expenses, net finance costs and taxation expense that are affected by the factors are as follows:

Table 11.12: Method of calculation of factors affecting Underlying Earnings

Factor affecting Underlying Earnings	Method of calculation	Financial statement line item affected
Change in volumes	Change in volumes for each Business from the corresponding period to the current period multiplied by the prior period Underlying EBIT margin.	Revenue and expenses
Change in sales prices	Change in average realised price for each Business from the corresponding period to the current period multiplied by current period volumes.	Revenue
Price-linked costs	Change in price-linked costs for each Business from the corresponding period to the current period multiplied by current period volumes.	Expenses
Operating cash costs	Change in total costs, other than price-linked costs, exchange rates, inflation on costs, non-cash costs and one-off items as defined below for each Business from the corresponding period to the current period.	Expenses
Exchange rates	Change in exchange rate multiplied by current period local currency revenue and expenses. The majority of the South32 Group's selling prices are denominated in US dollars and so there is little impact of exchange rate changes on revenue.	Revenue and expenses
Inflation on costs	Change in inflation rate applied to expenses, other than depreciation and amortisation, price-linked costs, exploration and business development expenses.	Expenses
Non-cash costs	Includes non-cash items, mainly depreciation and amortisation.	Expenses

Factor affecting Underlying Earnings	Method of calculation	Financial statement line item affected
Other	Variances not explained by the above factors.	Expenses
Net finance costs	Change in net finance costs from the corresponding period to the current period.	Net finance costs
Taxation expense	Change in taxation expense from the corresponding period to the current period.	Taxation expense

The following commentary describes the principal factors outlined in the table above for H1 FY2015, FY2014 and FY2013.

(1) Half year ended 31 December 2014 compared with half year ended 31 December 2013

(A) Volumes

Lower volumes at a number of South32 Businesses reduced Underlying EBIT in H1 FY2015 by US\$76 million; the major contributors were Cannington (US\$40 million), Australia Manganese (US\$27 million) and Illawarra Metallurgical Coal (US\$8 million). This was offset by volume efficiencies attributed to productivity and increased production in a number of South32 Businesses in H1 FY2015 that increased Underlying EBIT by US\$47 million. This was predominantly due to Brazil Aluminium (US\$15 million), Worsley Alumina (US\$12 million) and South African Energy Coal (US\$7 million).

(B) Prices

Higher average prices for most commodities increased Underlying EBIT in H1 FY2015 by US\$330 million; the major contributors were South Africa Aluminium (US\$121 million), Cerro Matoso (US\$73 million), Worsley (US\$59 million), Mozal Aluminium (US\$45 million) and Brazil Aluminium (US\$33 million). This was partially offset by lower average prices that reduced Underlying EBIT by US\$307 million, primarily at Illawarra Metallurgical Coal (US\$102 million), Manganese Australia (US\$68 million), Cannington (US\$72 million) and Manganese South Africa (US\$41 million).

(C) Operating cash costs

A broad-based improvement in productivity underpinned a decrease in operating cash costs of US\$155 million during H1 FY2015. The improvement in Underlying EBIT was most pronounced at Illawarra Metallurgical Coal (US\$139 million), Manganese Australia (US\$21 million) and Manganese South Africa (US\$21 million). The improvement was partially offset by increased costs at Brazil Aluminium (US\$41 million), Worsley Alumina (US\$32 million) and South Africa Aluminium (US\$23 million). The reduction can primarily be attributed to reduced labour, maintenance and consumables costs.

(D) Exchange rates

A stronger US dollar increased Underlying EBIT by US\$170 million in H1 FY2015. The benefit to Underlying EBIT was most pronounced in the South African South32 Businesses, with the benefits at South African Energy Coal, South Africa Manganese and South Africa Aluminium being US\$92 million in total. Average and closing exchange rates for H1 FY2015 are set out in Section 11.2(b).

(E) Inflation on costs

Inflation had an unfavourable impact on all South32 Businesses and reduced Underlying EBIT by US\$98 million during H1 FY2015. This was most notable in South Africa, where South African Energy Coal, South Africa Manganese and South Africa Aluminium had a total impact of US\$57 million.

(F) Non-cash costs

An increase in non-cash costs decreased Underlying EBIT by US\$10 million during the period.

(G) Other

Other items increased Underlying EBIT by US\$45 million.

(2) Year ended 30 June 2014 compared with year ended 30 June 2013

(A) Volumes

Lower volumes at a number of South32 Businesses reduced Underlying EBIT in FY2014 by US\$170 million, primarily at Cannington (US\$123 million) and Illawarra Metallurgical Coal (US\$23 million). This was offset by volume efficiencies attributed to productivity and increased production in a number of South32 Businesses in FY2014 that increased Underlying EBIT by US\$97 million. The major contributors were Australia Manganese (US\$45 million) and South Africa Energy Coal (US\$34 million).

(B) Prices

Lower average sale prices for most commodities reduced Underlying EBIT by US\$667 million in FY2014. The decreases were across all South32 Businesses except Worsley Alumina where realised prices for alumina in FY2014 of US\$318 per tonne were four per cent higher than FY2013, which increased Underlying EBIT by US\$55 million.

For Illawarra Metallurgical Coal, there was a 22 per cent decline in the average realised price of coking coal to US\$130 per tonne, which reduced Underlying EBIT by US\$263 million.

For Cannington, lower average realised prices for silver, which fell 26 per cent to US\$20 per ounce, were offset by an increase in lead prices of 15 per cent to US\$2,344 per tonne, along with an increase in zinc prices resulting in a US\$143 million decrease in Underlying EBIT.

Lower realised prices for aluminium at South Africa Aluminium (decrease of seven per cent to US\$2,007 per tonne) and Mozal Aluminium (decrease of 10 per cent to US\$2,080 per tonne) resulted in reduced Underlying EBIT for South Africa Aluminium and Mozal Aluminium of US\$79 million and US\$24 million, respectively.

Lower realised prices for manganese ore and alloy reduced Underlying EBIT for South Africa Manganese and Australia Manganese by US\$35 million and US\$62 million, respectively.

Nickel prices rallied towards the end of FY2014 but remained lower on average for the period, reducing Underlying EBIT for Cerro Matoso by US\$46 million.

Price-linked cost reductions increased Underlying EBIT by US\$6 million during the period. Reductions in price-linked costs at a number of South32 Businesses totalling US\$68 million that increased Underlying EBIT were offset by higher costs at other South32 Businesses. Australia Manganese suffered the largest increase in price-linked costs with a reduction in Underlying EBIT of US\$41 million, followed by South Africa Energy Coal (US\$10 million) and South Africa Aluminium (US\$10 million).

(C) Operating cash costs

A broad-based improvement in productivity underpinned a decrease in operating cash costs of US\$243 million during FY2014. The improvement in Underlying EBIT was most pronounced at South Africa Aluminium (US\$142 million), Illawarra Metallurgical Coal (US\$58 million) and South Africa Energy Coal (US\$53 million). The reduced cost was primarily for labour, maintenance and consumables.

(D) Exchange rates

A stronger US dollar increased Underlying EBIT by US\$602 million in FY2014. The benefit to Underlying EBIT was most pronounced in the South African South32 Businesses, with the benefits at South Africa Manganese and South Africa Energy Coal being US\$108 million each. Average and closing exchange rates for FY2014 and FY2013 are set out in Section 11.2(b).

(E) Inflation on costs

Inflation had an unfavourable impact on all South32 Businesses and reduced Underlying EBIT by US\$229 million during FY2014. This was most notable in South Africa and Australia, where the impact on Underlying EBIT was US\$126 million and US\$71 million, respectively.

(F) Non-cash costs

A reduction in non-cash costs increased Underlying EBIT by US\$13 million during the period.

(G) Other

Other items increased Underlying EBIT by US\$21 million.

(3) Year ended 30 June 2013 compared with year ended 30 June 2012

(A) Volumes

Higher volumes through productivity efficiencies at a number of South32 Businesses increased Underlying EBIT in FY2013 by US\$141 million, primarily at Illawarra Metallurgical Coal (US\$100 million), Australia Manganese (US\$15 million) and Cerro Matoso (US\$14 million). This was offset by lower volumes at other South32 Businesses, primarily at Cannington (US\$112 million). Overall the impact of volumes on Underlying EBIT was an increase of US\$5 million.

(B) Prices

Lower average sale prices for most commodities reduced Underlying EBIT by US\$1,354 million in FY2013.

The decreases were across all South32 Businesses except Australia Manganese and South Africa Manganese where realised prices for manganese ore in FY2013 were higher than FY2012, which increased Underlying EBIT by US\$96 million.

For Illawarra Metallurgical Coal, there was a 35 per cent decline in the average realised price of coking coal to US\$167 per tonne, which reduced Underlying EBIT by US\$657 million.

For South Africa Coal, there was a 23 per cent decline in the average realised price of export energy coal to US\$75 per tonne, which reduced Underlying EBIT by US\$366 million.

For Cerro Matoso, there was a 15 per cent decline in the average realised price of nickel metal to US\$15,442 per tonne, which reduced Underlying EBIT by US\$133 million.

For Worsley Alumina, there was a nine per cent decline in the average realised price of alumina to US\$307 per tonne, which reduced Underlying EBIT by US\$90 million.

Lower realised prices for aluminium at South Africa Aluminium (decrease of seven per cent to US\$2,154 per tonne) and Mozal Aluminium (decrease of two per cent to US\$2,318 per tonne) resulted in a reduction in Underlying EBIT for South Africa Aluminium and Mozal Aluminium of US\$47 million and US\$42 million, respectively.

For Cannington, lower average realised prices for silver, which fell 13 per cent to US\$27 per ounce, along with a small decrease in zinc prices, were offset by an eight per cent increase in lead prices, resulting in a US\$114 million decrease in Underlying EBIT.

Price-linked costs increased Underlying EBIT by US\$116 million during the period. Reductions in price-linked costs at a number of South32 Businesses totalling US\$145 million, primarily South Africa Aluminium (US\$77 million), Illawarra Metallurgical Coal (US\$31 million), Mozal Aluminium (US\$16 million) and Cerro Matoso (US\$16 million) increased Underlying EBIT. The increase in Underlying EBIT was offset by higher price-linked costs at Australia Manganese and South Africa Manganese totalling US\$29 million.

(C) Operating cash costs

Improvement in productivity at a number of South32 Businesses underpinned a decrease in operating cash costs of US\$256 million during FY2013. The improvement in Underlying EBIT was most pronounced at Worsley Alumina (US\$182 million), Australia Manganese (US\$96 million) and Illawarra Metallurgical Coal (US\$58 million) offset by higher costs at other South32 Businesses, primarily South Africa Aluminium (US\$46 million) and Cerro Matoso (US\$34 million). The reduced cost was primarily for contractor labour.

(D) Exchange rates

The US dollar had little impact on Australian dollar and Colombian peso costs in FY2013 whereas a stronger US dollar against the South African rand and Brazilian real resulted in an increase in Underlying EBIT of US\$334 million in FY2013. The benefit to Underlying EBIT was most pronounced in the South African South32 Businesses, with benefits at South Africa Manganese (US\$106 million), South Africa Energy Coal (US\$86 million) and South Africa Aluminium (US\$61 million). Average and closing exchange rates for FY2013 and FY2012 are set out in Section 11.2(b).

(E) Inflation on costs

Inflation had an unfavourable impact on almost all South32 Businesses and reduced Underlying EBIT by US\$228 million during FY2013. This was most notable in South Africa and Australia, where the impact on Underlying EBIT was US\$135 million and US\$67 million respectively.

(F) Non-cash costs

A reduction in non-cash costs increased Underlying EBIT by US\$86 million during the period.

(G) Other

Other items increased Underlying EBIT by US\$13 million.

(b) Net finance costs

South32's financing in historical periods was primarily provided on an intercompany basis by BHP Billiton. The analysis below is based on the historical combined financial information.

(1) Half year ended 31 December 2014 compared with half year ended 31 December 2013

Net finance costs decreased to US\$37 million from US\$108 million in H1 FY2015 compared to H1 FY2014. After excluding net finance costs associated with BHP Billiton centrally managed borrowings, net finance costs in H1 FY2015 were US\$2 million income compared to US\$64 million expense in H1 FY2014.

(2) Year ended 30 June 2014 compared with year ended 30 June 2013

Net finance costs increased to US\$352 million from US\$133 million in the corresponding period. After excluding net finance costs associated with BHP Billiton centrally managed borrowings, net finance costs in FY2014 were US\$262 million compared to US\$127 million in FY2013. This was primarily attributable to exchange rate variations on net debt, increasing from a US\$16 million exchange gain in FY2013 to a US\$40 million exchange loss in FY2014, additional interest on finance leases of US\$32 million and a US\$40 million increase in interest expense on borrowings other than bank loans.

(3) Year ended 30 June 2013 compared with year ended 30 June 2012

Net finance costs increased to US\$133 million in FY2013 from US\$42 million in the corresponding period. After excluding net finance costs associated with BHP Billiton centrally managed borrowings, net finance costs in FY2013 were US\$127 million compared to US\$84 million in FY2012. Interest paid on a number of borrowings were higher in FY2013; however, there was no interest capitalised as compared to FY2012 when US\$82 million was capitalised for the Worsley Alumina expansion project.

(c) Taxation expense

The effective tax rates presented for the historical periods are based on BHP Billiton's structure and may not reflect South32's tax rate post Demerger. The tax rates set out in the historical combined financial information have been impacted by items outside the ordinary course of business. The table below presents the reconciliation between the statutory effective tax rate and the adjusted effective tax rate which is not an IFRS measure:

Table 11.13: Adjusted effective tax rate

	H1 FY2015			FY2014			FY2013			FY2012		
	Profit/(loss) before tax US\$M	Income tax expense US\$M	%	Profit/(loss) before tax US\$M	Income tax expense US\$M	%	Profit/(loss) before tax US\$M	Income tax expense US\$M	%	Profit/(loss) before tax US\$M	Income tax expense US\$M	%
Statutory effective tax rate	1,214	(476)	39.2	422	(205)	48.6	(1,096)	(208)	(19.0)	2,018	(585)	29.0
Less:												
Amounts excluded from net finance costs	(66)	20		130	(39)		(10)	3		(86)	26	
Amounts excluded from Underlying EBIT	(451)	27		296	(21)		2,117	(528)		(134)	48	
Exchange rate movements	-	155		-	4		-	84		-	123	
Remeasurement of deferred tax assets associated with the MRRT	-	111		-	-		-	142		-	(196)	
Non-recognition of tax benefits where tax benefit remains with BHP Billiton	-	-		-	27		-	251		-	44	
Adjusted effective tax rate	697	(163)	23.4	848	(234)	27.6	1,011	(256)	25.3	1,798	(540)	30.0

(1) Half year ended 31 December 2014 compared with half year ended 31 December 2013

Total taxation expense, including royalty-related taxation, the tax impacts of amounts excluded from Underlying EBIT and exchange rate movements, was US\$476 million, representing an effective tax rate of 39.2 per cent.

The remeasurement of deferred tax assets associated with the MRRT impacted taxation expense by US\$111 million in H1 FY2015.

South32's adjusted effective tax rate, which excludes the influence of exchange rate movements, remeasurements of deferred tax assets associated with the MRRT, non-recognition of tax benefits when the tax benefit remains with BHP Billiton, the tax impact of earnings adjustments to net finance costs and the tax impacts of amounts excluded from Underlying EBIT, was 23.4 per cent.

Adjusted effective tax rate is not an IFRS measure and is reconciled to the statutory effective tax rate in Table 11.13.

(2) Year ended 30 June 2014 compared with year ended 30 June 2013

Total taxation expense, including royalty-related taxation, the tax impacts of amounts excluded from Underlying EBIT and exchange rate movements, was US\$205 million, representing an effective tax rate of 48.6 per cent (FY2013: negative 19.0 per cent).

The remeasurement of deferred tax assets associated with the MRRT had no impact on taxation expense in FY2014 (FY2013: increase of US\$142 million). Royalty-related MRRT credits in Illawarra Metallurgical Coal decreased taxation expense by US\$40 million in FY2014 (FY2013: US\$nil).

South32's adjusted effective tax rate, which excludes the influence of exchange rate movements, remeasurements of deferred tax assets associated with the MRRT, non-recognition of tax benefits when the tax benefit remains with BHP Billiton, the tax impact of earnings adjustments to net finance costs and the tax impacts of amounts excluded from Underlying EBIT, was 27.6 per cent (FY2013: 25.3 per cent).

Other royalty and excise arrangements that are not profit-based are recognised as operating costs within profit/(loss) before taxation. These amounted to US\$348 million during the period (FY2013: US\$383 million).

(3) Year ended 30 June 2013 compared with year ended 30 June 2012

Total taxation expense, including royalty-related taxation, the tax impacts of amounts excluded from Underlying EBIT and exchange rate movements, was US\$208 million, representing an effective tax rate of negative 19.0 per cent (FY2012: 29.0 per cent).

The MRRT increased taxation expense by US\$142 million in FY2013 due to de-recognition of the tax base for MRRT purposes in Illawarra Metallurgical Coal (FY2012: decrease of US\$196 million).

South32's adjusted effective tax rate, which excludes the influence of exchange rate movements, remeasurements of deferred tax assets associated with MRRT, non-recognition of tax benefits when the tax benefit remains with BHP Billiton, the tax impact of earnings adjustments to net finance costs and the tax impacts of amounts excluded from Underlying EBIT, was 25.3 per cent (FY2012: 30.0 per cent).

Other royalty and excise arrangements that are not profit-based are recognised as operating costs within profit/(loss) before taxation. These amounted to US\$383 million during the period (FY2012: US\$413 million).

(d) Earnings adjustments

Earnings adjustments are excluded from Underlying EBIT and Underlying Earnings in order to enhance the comparability from period to period of, and provide clarity into, the underlying performance of South32's operations.

Table 11.14: Earnings adjustments

US\$M	6 months ended December		12 months ended June		
	H1 FY2015	H1 FY2014	FY2014	FY2013	FY2012
Earnings adjustments to Underlying EBIT					
Exchange gains on restatement of monetary items	(82)	(47)	(68)	(97)	(100)
Impairment losses	-	-	327	2,225	108
Impairment reversals	-	(2)	(8)	(15)	-
Fair value (gain)/loss on derivative instruments	(5)	16	2	16	(122)
Dividends received from BHP Billiton	(364)	(11)	(11)	(12)	(20)
Other:					
Bayside closure costs (excluding impairments)	-	-	138	-	-
Gain on sale of Optimum coal rights	-	-	(84)	-	-
Total earnings adjustments to Underlying EBIT	(451)	(44)	296	2,117	(134)
Earnings adjustments to net finance costs					
Exchange variations on net debt	(105)	(1)	40	(16)	(44)
Interest on borrowings from BHP Billiton	64	61	115	108	76
Interest income on loans to BHP Billiton	(25)	(17)	(25)	(102)	(118)
Total earnings adjustments to net finance costs	(66)	43	130	(10)	(86)
Earnings adjustments to income tax expense					
Tax effect of earnings adjustments to Underlying EBIT	27	8	(21)	(528)	48
Tax effect of earnings adjustments to net finance costs	20	(13)	(39)	3	26
Exchange rate movements	155	3	4	84	123
Remeasurement of deferred tax assets associated with the MRRT	111	(25)	-	142	(196)
Non-recognition of tax benefits where benefit remains with BHP Billiton	-	39	27	251	44
Total earnings adjustments to income tax expense	313	12	(29)	(48)	45
Total earnings adjustments	(204)	11	397	2,059	(175)

(1) Exchange gains on restatement of monetary items

South32's functional and reporting currency is US dollars. Realised and unrealised gains and losses on restatement of monetary items denominated in local currencies as a result of movements in exchange rates are recorded in profit or loss for the year.

(2) Impairment losses and impairment reversals

There were no impairments or impairment reversals recorded in H1 FY2015.

Total impairment losses in FY2014 were US\$327 million. This primarily related to impairments at South Africa Energy Coal where impairments of property, plant and equipment of US\$244 million and of goodwill of US\$48 million were recognised as a result of royalty legislation changes, a decline in export prices, a required five per cent rail allocation to Junior BBEE miners and increased geologic loss.

Total impairment losses in FY2013 were US\$2,225 million. This primarily related to an impairment of assets at Worsley Alumina of US\$2,190 million as a result of expected continued strength in the Australian dollar and weak alumina prices.

Total impairments in FY2012 were US\$108 million. This arose primarily as part of BHP Billiton's regular portfolio review, as a result of which production at TEMCO was temporarily suspended, Metalloys South Plant was permanently closed and the Samancor Manganese Gabon project was terminated. As a result, impairment charges of US\$93 million were recognised.

(3) Derivative instruments

Hillside sources power from Eskom, the South African state utility, under long-term contracts, with prices linked to the LME price of aluminium or the producer price indices for South Africa and the United States. The embedded derivatives in the host contracts are accounted for at fair value. The gain or loss on changes in the fair value of these derivatives is recorded in profit or loss for the year.

(4) Bayside closure

As a result of the cessation of aluminium smelting activities at Bayside in June 2014, a charge of US\$138 million was recorded (excluding US\$29 million of impairment of property, plant and equipment) representing closure and cessation costs.

(5) Optimum coal rights

Following the sale of the Optimum Colliery in FY2008, South32 retained the right to sell coal on behalf of the new owners, Optimum Coal Holdings (Pty) Ltd. This right has now been sold and generated a profit on disposal of US\$84 million.

(6) Dividends received from BHP Billiton Group companies

Dividends received from BHP Billiton Group companies are excluded from Underlying Earnings because these amounts will not continue following the Demerger.

(7) Earnings adjustments to net finance costs

Exchange variations on net debt are excluded from Underlying Earnings, consistent with exchange variations included in profit from operations.

Interest expense on borrowings from BHP Billiton Group companies and interest income on loans to BHP Billiton Group companies are excluded from Underlying Earnings because these amounts will not continue following the Demerger.

(8) Earnings adjustments to income tax expense

The earnings adjustments to income tax expense include the tax effect of the adjustments to Underlying EBIT and net finance costs. Exchange rate movements relate to the impact on income tax expense for companies in the South32 Group where the functional currency for taxation purposes is not US dollars. As a result, exchange gains and losses are calculated differently for accounting and tax purposes. Remeasurement of deferred tax assets associated with the MRRT is excluded because the tax has been repealed. Additional tax expense arising where the tax benefit of losses remains with BHP Billiton has been excluded from Underlying Earnings because these amounts will not continue following the Demerger.

11.6 BUSINESS PERFORMANCE

The following tables provide a summary of revenue and Underlying EBIT for H1 FY2015, H1 FY2014, FY2014, FY2013 and FY2012 of the South32 Businesses. The use of Underlying EBIT is explained in Section 11.3.

Table 11.15: Revenue contribution by Business

US\$M	6 months ended December		12 months ended June		
	H1 FY2015	H1 FY2014	FY2014	FY2013	FY2012
Revenue					
Worsley Alumina	651	565	1,229	1,130	992
South Africa Aluminium	823	796	1,614	1,663	1,646
Mozal Aluminium	340	291	574	612	629
Brazil Aluminium	268	266	529	637	660
South Africa Energy Coal	683	639	1,247	1,458	1,894
Illawarra Metallurgical Coal	425	410	878	1,287	1,701
Australia Manganese	566	677	1,308	1,257	1,204
South Africa Manganese	386	350	788	856	932
Cerro Matoso	340	315	595	803	876
Cannington	486	605	1,079	1,365	1,590
Third party products	404	776	1,262	1,663	2,359
Intersegment revenue	(332)	(342)	(659)	(638)	(648)
South32 Group	5,040	5,348	10,444	12,093	13,835

Table 11.16: Underlying EBIT contribution by Business

US\$M	6 months ended December		12 months ended June		
	H1 FY2015	H1 FY2014	FY2014	FY2013	FY2012
Underlying EBIT					
Worsley Alumina	67	45	24	(115)	(194)
South Africa Aluminium	167	48	121	1	(83)
Mozal Aluminium	70	(1)	16	(3)	18
Brazil Aluminium	101	(7)	44	(40)	(80)
South Africa Energy Coal	(9)	(44)	4	(96)	226
Illawarra Metallurgical Coal	20	(8)	(35)	154	659
Australia Manganese	162	216	414	436	282
South Africa Manganese	26	(9)	48	58	(51)
Cerro Matoso	86	1	(1)	155	337
Cannington	154	251	413	611	840
Third party products	30	28	29	63	94
Group and unallocated items	(74)	(10)	(7)	(70)	(122)
South32 Group	800	510	1,070	1,154	1,926

(a) Worsley Alumina

Table 11.17: Worsley Alumina financial information

US\$M, unless otherwise stated	6 months ended December		12 months ended June		
	H1 FY2015	H1 FY2014	FY2014	FY2013	FY2012
Revenue	651	565	1,229	1,130	992
Underlying EBITDA	143	108	162	60	(67)
Underlying EBIT	67	45	24	(115)	(194)
Capital expenditure	27	22	56	154	900
Net operating assets	3,413	2,862	3,418	2,868	5,105
Production – alumina (kt)	1,953	1,970	3,916	3,675	2,917

(1) Half year ended 31 December 2014 compared with half year ended 31 December 2013

Alumina production decreased by one per cent to 1,953 kt for H1 FY2015.

Revenue in H1 FY2015 was US\$651 million, an increase of US\$86 million, or 15 per cent, from US\$565 million in the corresponding period. The increase in revenue at Worsley Alumina was primarily due to higher realised prices, which contributed to an additional increase of US\$59 million. During the period, the average realised price of alumina increased by 10 per cent to US\$335 per tonne.

Underlying EBITDA for H1 FY2015 increased by US\$35 million to US\$143 million. Movements in finished goods inventory at the Alumina refinery contributed to a reduction in Underlying EBITDA of US\$44 million. This was offset by the impact of a stronger US dollar against the Australian dollar, which increased Underlying EBITDA by US\$12 million.

Underlying EBIT for H1 FY2015 was US\$67 million, an increase of US\$22 million from the corresponding period. An increased fixed asset base at H1 2015 contributed to a US\$13 million increase in depreciation expense and non-cash costs, compared with the corresponding period.

(2) Year ended 30 June 2014 compared with year ended 30 June 2013

Alumina production in FY2014 increased by seven per cent to a record 3,916 kt. An expansion project at Worsley Alumina, which commenced in FY2008 to increase the capacity of the refinery from 3.5 Mtpa to 4.6 Mtpa (100 per cent) of alumina, reached nominal capacity during the year, resulting in the annual production record.

Revenue in FY2014 was US\$1,229 million, an increase of US\$99 million, or nine per cent, from US\$1,130 million in the corresponding period. The increase in revenue at Worsley Alumina was primarily due to the increase in volume noted above, which contributed to an increase in revenue of US\$55 million, and to higher realised prices, which contributed to an additional increase of US\$55 million. Following the revision of pricing terms during the period, the average price of alumina increased by four per cent to US\$318 per tonne.

Underlying EBITDA for FY2014 increased by US\$102 million to US\$162 million. The increase in production noted above resulted in an increase of US\$58 million in volume-related costs, with a net volume-related decrease in Underlying EBITDA of US\$3 million. A reduction in consumable costs and equipment 'debottlenecking' (improving supply chain and processing efficiency and increasing the capacity of the refinery) contributed to the US\$8 million of productivity cost efficiencies achieved during the period. A stronger US dollar against the Australian dollar increased Underlying EBITDA by a further US\$79 million. In contrast, increases in costs attributable to inflation were US\$25 million.

Underlying EBIT for FY2014 was US\$24 million, an increase of US\$139 million from the corresponding period. Non-cash costs contributed US\$56 million in cost efficiencies, which was driven by lower depreciation expenses following impairments recognised in the corresponding period.

(3) Year ended 30 June 2013 compared with year ended 30 June 2012

Alumina production increased by 26 per cent in FY2013 to 3,675 kt, underpinned by the ramp up of the expansion project.

Revenue in FY2013 was US\$1,130 million, an increase of US\$138 million, or 14 per cent, from US\$992 million in the corresponding period. The increase in revenue at Worsley Alumina was primarily due to the increase in volume noted above, which contributed to an increase in revenue of US\$237 million. In contrast, weaker markets continued to challenge the business with a nine per cent decline in average realised price of alumina to US\$307 per tonne, which reduced revenue by US\$90 million.

Underlying EBITDA for FY2013 increased by US\$127 million to US\$60 million. Volume related costs increased by US\$242 million in FY2013 in line with productivity movements noted above, with a net volume related decrease in Underlying EBITDA of US\$5 million. Productivity improvements enabled substantial savings in operating cash costs of US\$182 million to be achieved during the period, partially offset by the negative impact of inflation on costs which decreased Underlying EBITDA by US\$21 million.

Underlying EBIT for FY2013 was a loss of US\$115 million, a decrease of US\$79 million from the corresponding period. Non-cash costs contributed US\$16 million to the decrease in Underlying EBIT, which was driven by higher depreciation expenses following the completion of the Efficiency and Growth project.

(b) South Africa Aluminium

Table 11.18: South Africa Aluminium financial information

US\$M, unless otherwise stated	6 months ended December		12 months ended June		
	H1 FY2015	H1 FY2014	FY2014	FY2013	FY2012
Revenue	823	796	1,614	1,663	1,646
Underlying EBITDA	201	84	190	73	(10)
Underlying EBIT	167	48	121	1	(83)
Capital expenditure	10	7	28	17	14
Net operating assets	1,195	1,399	1,195	1,382	1,528
Production – Aluminium (kt)	356	415	804	761	719

(1) Half year ended 31 December 2014 compared with half year ended 31 December 2013

Aluminium production at South Africa Aluminium decreased by 59 kt or 14 per cent to 356 kt in H1 FY2015.

Revenue in H1 FY2015 was US\$823 million, an increase of US\$27 million or three per cent from the prior period. The primary driver of this increase was the rise in realised prices of aluminium, which rose 18 per cent to US\$2,338 per tonne, resulting in a US\$121 million increase in revenue. This was offset by a US\$99 million decrease in revenue following the cessation of smelting activities at Bayside in June 2014.

Underlying EBITDA increased by US\$117 million in H1 FY2015 to US\$201 million. The reduction in operating cash costs related to the cessation of smelting activities at Bayside was US\$113 million, resulting in a net increase to Underlying EBITDA of US\$14 million. The weakening South African rand against the US dollar resulted in a positive impact to Underlying EBITDA of US\$18 million due to local currency costs. This was offset by an increase in structural operating-related costs, raw materials, labour and price-linked costs of US\$48 million.

Underlying EBIT increased by US\$119 million in H1 FY2015 to US\$167 million, in line with movements noted in Underlying EBITDA.

(2) Year ended 30 June 2014 compared with year ended 30 June 2013

Aluminium production in FY2014 increased by 43 kt or six per cent to 804 kt, with Hillside reaching a new production record of 715 kt. This was partially offset by reduced volumes at Bayside, which fell seven per cent to 89 kt in FY2014.

Revenue in FY2014 was US\$1,614 million, a decrease of US\$49 million or three per cent from the prior period. The increase in production volumes contributed to a US\$93 million increase to revenue. This was offset by the fall in realised aluminium prices, which fell seven per cent to US\$2,007 per tonne and resulted in a US\$79 million reduction in revenue.

Underlying EBITDA increased by US\$117 million in FY2014 to US\$190 million. Volume-related cost variances at Hillside and Bayside were US\$91 million, resulting in a net volume-related increase to Underlying EBITDA of US\$2 million. Efficiencies gained in electricity consumption and maintenance activities resulted in US\$142 million of operating cash cost savings and consequent increase to Underlying EBITDA. The impact of inflationary pressures on operating costs was a reduction to Underlying EBITDA of US\$22 million. The weakening South African rand against the US dollar resulted in a positive impact to Underlying EBITDA of US\$53 million due to local currency costs.

Underlying EBIT increased by US\$120 million in FY2014 to US\$121 million, in line with movements noted in Underlying EBITDA.

(3) Year ended 30 June 2013 compared with year ended 30 June 2012

The increased availability of pots in production in FY2013 contributed to a 42 kt increase in total production at Hillside and Bayside for the period.

Revenue in FY2013 was US\$1,663 million, an increase of US\$17 million from FY2012. The volume-related impact to revenue was an increase of US\$78 million. This was more than offset by the decrease in realised aluminium prices, which fell seven per cent to US\$2,154 per tonne, resulting in a US\$47 million reduction to revenue.

Underlying EBITDA increased by US\$83 million to US\$73 million in FY2013. The volume-related cost impact was an increase of US\$75 million resulting in a net volume-related increase in Underlying EBITDA of US\$3 million. Cost efficiencies noted in operating cash costs were offset by increased expenditure relating to maintenance of the processing plant, resulting in a net decrease to Underlying EBITDA of US\$46 million. Price-linked costs resulted in an increase to Underlying EBITDA of US\$77 million due to the decrease in the cost of alumina. Inflation in South Africa and the United States resulted in a reduction to Underlying EBITDA of US\$31 million. The weakening South African rand against the US dollar resulted in a US\$61 million favourable impact on local currency costs and increase to Underlying EBITDA.

Underlying EBIT increased by US\$84 million from FY2012, in line with movements in Underlying EBITDA.

(c) Mozal Aluminium

Table 11.19: Mozal Aluminium financial information

US\$M, unless otherwise stated	6 months ended December		12 months ended June		
	H1 FY2015	H1 FY2014	FY2014	FY2013	FY2012
Revenue	340	291	574	612	629
Underlying EBITDA	88	17	52	31	51
Underlying EBIT	70	(1)	16	(3)	18
Capital expenditure	5	3	8	7	9
Net operating assets	628	634	627	669	777
Production – aluminium (kt)	135	134	266	264	264

(1) Half year ended 31 December 2014 compared with half year ended 31 December 2013

Aluminium production remained fairly consistent at 135 kt over the period.

Revenue increased by US\$49 million in H1 FY2015 to US\$340 million, primarily driven by the impact of higher realised prices. Realised prices for aluminium increased by 21 per cent to US\$2,482 per tonne, which resulted in a US\$45 million increase in revenue.

Underlying EBITDA increased by US\$71 million from US\$17 million in H1 FY2014 to US\$88 million in H1 FY2015. The impact of higher realised prices noted above was offset by a US\$5 million increase in price-linked costs, relating to the cost of alumina. The focus on productivity improvements contributed to operating cost efficiencies of US\$31 million. Operating costs are subject to the impact of inflation on US dollar, South African rand and Mozambique metical denominated costs, which resulted in a reduction to Underlying EBITDA of US\$6 million. This was offset by the strength of the US dollar against both the South African rand and Mozambique metical contributing to a US\$6 million increase to Underlying EBITDA on the translation of local currency operating costs.

Underlying EBIT increased by US\$71 million from a loss of US\$1 million in H1 FY2014 to US\$70 million in H1 FY2015 in line with movements in Underlying EBITDA.

(2) Year ended 30 June 2014 compared with year ended 30 June 2013

Aluminium production remained fairly consistent at 266 kt over the period.

Revenue decreased by US\$38 million in FY2014 to US\$574 million, primarily driven by the impact of lower realised prices. Realised prices for aluminium decreased by 10 per cent to US\$2,080 per tonne, which resulted in a US\$24 million reduction in revenue.

Underlying EBITDA increased by US\$21 million from US\$31 million in FY2013 to US\$52 million in FY2014. The impact of lower realised prices noted above was offset by a US\$13 million saving in price-linked costs, relating to the cost of alumina. The focus on productivity improvements contributed to cost efficiencies of US\$15 million. Operating costs are subject to the impact of inflation on US dollar, South African rand and Mozambique metical denominated costs, which resulted in a reduction to Underlying EBITDA of US\$13 million. The strength of the US dollar against both the South African rand and Mozambique metical contributed to a US\$30 million increase to Underlying EBITDA on the translation of operating costs.

Underlying EBIT increased by US\$19 million from a loss of US\$3 million in FY2013 to US\$16 million in FY2014 in line with movements in Underlying EBITDA.

(3) Year ended 30 June 2013 compared with year ended 30 June 2012

Aluminium production at Mozal Aluminium in FY2013 remained unchanged with production of 264 kt.

Revenue in FY2013 was US\$612 million, a decrease of US\$17 million from FY2012. Realised prices for aluminium fell two per cent to US\$2,318 per tonne in FY2013, which resulted in a US\$26 million decrease to revenue, net of price-linked costs.

Underlying EBITDA decreased by US\$20 million to US\$31 million in FY2013. Increased maintenance and electricity costs contributed to higher operating cash costs of US\$11 million and the impact of US, Mozambique and South African inflation further decreased Underlying EBITDA by US\$12 million. The weakening Mozambique metical and South African rand against the US dollar contributed to a US\$25 million increase to Underlying EBITDA.

Underlying EBIT decreased by US\$21 million to a loss of US\$3 million in FY2013 due to the decrease in Underlying EBITDA.

(d) Brazil Aluminium

Table 11.20: Brazil Aluminium financial information

US\$M, unless otherwise stated	6 months ended December		12 months ended June		
	H1 FY2015	H1 FY2014	FY2014	FY2013	FY2012
Revenue	268	266	529	637	660
Underlying EBITDA	140	35	127	44	3
Underlying EBIT	101	(7)	44	(40)	(80)
Capital expenditure	5	7	9	6	12
Net operating assets	938	1,010	968	1,031	1,144
Production – alumina (kt)	680	633	1,262	1,205	1,235
Production – aluminium (kt)	26	63	104	154	170

(1) Half year ended 31 December 2014 compared with half year ended 31 December 2013

Alumina production at Brazil Aluminium increased by seven per cent in H1 FY2015 to 680 kt. In contrast, aluminium production decreased by 59 per cent to 26 kt in H1 FY2015, driven by the decision to keep potlines II and III curtailed following the suspension of production at June 2014.

Revenue increased by US\$2 million to US\$268 million in H1 FY2015. Volume-related variances arising from the production results noted above, contributed to a US\$34 million reduction in revenue.

Realised prices for aluminium and alumina rose 20 per cent to US\$2,360 per tonne and 10 per cent to US\$323 per tonne respectively in H1 FY2015. The net impact of movements in realised prices year on year was a US\$34 million increase in revenue.

Underlying EBITDA increased by US\$105 million to US\$140 million in H1 FY2015 from US\$35 million in H1 FY2014. Volume-related savings in operating costs were US\$49 million, with a net volume-related increase in Underlying EBITDA of US\$15 million. The impact of inflation on operating costs against both the US dollar and the Brazil real resulted in a decrease to Underlying EBITDA of US\$12 million. This was offset by the strengthening US dollar against the Brazil real which contributed to a US\$22 million increase to Underlying EBITDA. The continued suspension of production from potlines II and III resulted in excess contracted power which was subsequently sold in the market at a positive margin, increasing Underlying EBITDA by US\$90 million.

Underlying EBIT increased by US\$108 million to US\$101 million in H1 FY2015, in line with movements in Underlying EBITDA.

(2) Year ended 30 June 2014 compared with year ended 30 June 2013

Alumina production reached annual production records in FY2014, increasing by five per cent to 1,262 kt. This was achieved through faster turnarounds during planned maintenance and structural improvements made to the plant equipment. In contrast, aluminium production decreased by 32 per cent to 104 kt in FY2014, driven by the decision to suspend production from potlines II and III due to challenging market conditions in primary aluminium and increased costs.

Revenue decreased by US\$108 million to US\$529 million in FY2014. Volume-related variances driven by production results noted above, contributed to a US\$77 million reduction in revenue. Realised prices for aluminium fell three per cent to US\$2,000 per tonne in FY2014. Alumina prices rose one per cent to US\$300 per tonne in FY2014. The net impact of movements in realised prices year on year was a US\$17 million reduction in revenue.

Underlying EBITDA increased by US\$83 million to US\$127 million in FY2014 from US\$44 million in FY2013. Volume-related savings in operating costs were US\$94 million, with a net volume-related increase in Underlying EBITDA of US\$17 million. The impact of inflation on operating costs against both the US dollar and the Brazil real resulted in a decrease to Underlying EBITDA of US\$11 million. This was offset by the strengthening US dollar against the Brazil real which contributed to a US\$8 million increase to Underlying EBITDA. The suspension of production from potlines II and III resulted in excess contracted power which was subsequently sold in the market at a positive margin, increasing EBITDA by US\$89 million.

Underlying EBIT increased by US\$84 million to US\$44 million in FY2014 in line with movements in Underlying EBITDA.

(3) Year ended 30 June 2013 compared with year ended 30 June 2012

Aluminium production was reduced in FY2013 in an effort to reduce operational costs. This led to a decrease of nine per cent to 154 kt. Alumina production fell two per cent to 1,205 kt due to the high number of power sags.

Revenue fell US\$23 million or three per cent to US\$637 million in FY2013. The impact to revenue on the decrease in volumes was US\$44 million. Aluminium prices fell eight per cent to US\$2,061 per tonne, with alumina prices falling nine per cent to US\$296 per tonne, contributing to an overall decrease to revenue of US\$13 million.

Underlying EBITDA increased by US\$41 million to US\$44 million in FY2013. Volume-related cost savings due to lower sales volumes were US\$25 million with a net volume-related decrease in Underlying EBITDA of US\$19 million. Productivity improvements continued to advance in FY2013 leading to the achievement of cost savings of US\$22 million, while a stronger US dollar increased Underlying EBITDA by US\$34 million. In contrast, the impact of inflation resulted in a reduction to Underlying EBITDA of US\$18 million. Excess electricity from reduced production was sold in the market at a premium, resulting in an increase to Underlying EBITDA of US\$32 million.

Underlying EBIT increased by US\$40 million to a loss of US\$40 million in FY2013 in line with movements in Underlying EBITDA.

(e) South Africa Energy Coal

Table 11.21: South Africa Energy Coal financial information

US\$M, unless otherwise stated	6 months ended December		12 months ended June		
	H1 FY2015	H1 FY2014	FY2014	FY2013	FY2012
Revenue	683	639	1,247	1,458	1,894
Underlying EBITDA	83	54	197	115	416
Underlying EBIT	(9)	(44)	4	(96)	226
Capital expenditure	58	22	65	133	162
Net operating assets	1,014	1,313	989	1,334	1,425
Production – energy coal (kt)	16,525	14,973	30,384	31,627	33,279

(1) Half year ended 31 December 2014 compared with half year ended 31 December 2013

Energy coal production of 16,525 kt for H1 FY2015 was a 10 per cent increase from the corresponding period, as a direct result of yield gains from improved plant availability.

Revenue in H1 FY2015 was US\$683 million, an increase of US\$44 million or seven per cent from the prior period. Higher production volumes noted above contributed to a US\$98 million increase in revenue. This was offset by a decrease in average realised export prices for thermal coal, resulting in a US\$32 million decrease in revenue, inclusive of price-linked costs. Realised export thermal coal prices fell 13 per cent to US\$60 per tonne while the average realised domestic price increased from US\$22 per tonne in H1 FY2014 to US\$23 per tonne in H1 FY2015. A stronger US dollar against the South African rand contributed to a US\$18 million decrease in domestic local currency-based revenue.

Underlying EBITDA increased by US\$29 million to US\$83 million in H1 FY2015. The impact of the increase in sales volumes on operational costs was US\$90 million, resulting in a net volume-related increase in Underlying EBITDA of US\$8 million. A reduction in labour and contractor head count contributed to cost savings and an increase in Underlying EBITDA of US\$47 million. These savings were offset by a US\$42 million reduction in Underlying EBITDA due to the impact of inventory movements on mining-related costs. Inflationary pressures in South Africa increased operating costs and reduced Underlying EBITDA by US\$36 million. This was partially offset by the benefit of translation of local currency operating costs which contributed to an increase to Underlying EBITDA of US\$32 million.

Underlying EBIT increased by US\$35 million to a loss of US\$9 million in H1 FY2015, in line with movements in Underlying EBITDA noted above.

(2) Year ended 30 June 2014 compared with year ended 30 June 2013

Energy coal production of 30,384 kt for FY2014 was a four per cent decrease from the prior period as a direct result of extended outages at both a local utility and the Richards Bay Coal Terminal.

Revenue in FY2014 was US\$1,247 million, a reduction of US\$211 million or 14 per cent from the prior period. Lower production volumes noted above contributed to a US\$82 million reduction in revenue. A decrease in average realised prices for thermal coal resulted in a US\$47 million decrease in revenue. Realised export thermal coal prices fell 12 per cent to US\$66 per tonne due to a combination of market conditions and a higher weighting of lower quality coal sales for FY2014 compared to FY2013. The average domestic price realised decreased from US\$23 per tonne in FY2013 to US\$22 per tonne in FY2014. A stronger US dollar against the South African rand contributed to a US\$73 million decrease in domestic local currency-based revenue.

Underlying EBITDA increased by US\$82 million to US\$197 million in FY2014. The impact of the reduction in sales volumes on operational costs was US\$116 million, resulting in a net volume-related increase in Underlying EBITDA of US\$34 million. A reduction in labour, contractor and maintenance costs resulted in cost efficiencies and an increase to Underlying EBITDA of US\$53 million. Inflationary pressures in South Africa increased operating costs and reduced Underlying EBITDA by US\$65 million. This was more than offset by exchange gains realised on the translation of operating costs, which contributed to an increase to Underlying EBITDA of US\$182 million.

Underlying EBIT increased by US\$100 million to US\$4 million in FY2014, in line with movements in Underlying EBITDA noted above.

(3) Year ended 30 June 2013 compared with year ended 30 June 2012

Energy coal production decreased by five per cent to 31,627 kt in FY2013 due to the depletion of Block A at Khutala in July 2012 and the impact of challenging geological and mining conditions at Wolvekrans mine.

Revenue in FY2013 was US\$1,458 million, a reduction of US\$436 million or 23 per cent from FY2012. Volume-related variances contributed to a US\$53 million reduction in revenue. Realised export and domestic thermal coal prices fell during FY2013, resulting in a US\$366 million decrease in revenue. The translation of domestic local currency revenue into US dollars, resulted in an unfavourable reduction to revenue of US\$59 million.

Underlying EBITDA decreased by US\$301 million or 72 per cent to US\$115 million in FY2013. Volume-related operating cost variances were US\$60 million, resulting in a net volume-related increase in Underlying EBITDA of US\$7 million. Higher diesel, labour and contractor and equipment maintenance costs resulted in a decrease to Underlying EBITDA of US\$24 million. Inflationary pressures on mining and railage costs contributed to a US\$75 million reduction in Underlying EBITDA. The translation of operating costs resulted in a net increase to Underlying EBITDA of US\$174 million, due to the weakening South African rand to US dollar exchange rate.

Underlying EBIT decreased by US\$322 million to a loss of US\$96 million in FY2013. Further to the movements noted above, depreciation and amortisation expenses increased US\$21 million, resulting in a corresponding decrease to Underlying EBIT.

(f) Illawarra Metallurgical Coal

Table 11.22: Illawarra Metallurgical Coal financial information

US\$M, unless otherwise stated	6 months ended December		12 months ended June		
	H1 FY2015	H1 FY2014	FY2014	FY2013	FY2012
Revenue	425	410	878	1,287	1,701
Underlying EBITDA	120	70	135	302	818
Underlying EBIT	20	(8)	(35)	154	659
Capital expenditure	180	173	309	357	314
Net operating assets	1,534	1,313	1,384	1,238	1,058
Production – energy coal (kt)	880	741	1,539	1,278	1,305
Production – metallurgical coal (kt)	3,858	2,614	5,974	6,664	6,621

(1) Half year ended 31 December 2014 compared with half year ended 31 December 2013

Metallurgical coal and energy coal production in H1 FY2015 increased by 48 per cent to 3,858 kt and 19 per cent to 880 kt, respectively. The increase was due to lower raw coal production out of the Dendrobium mine in H1 FY2014 as a result of extended outages.

Revenue in H1 FY2015 was US\$425 million, an increase of US\$15 million or four per cent from the corresponding period. The increase in raw coal production contributed to a US\$121 million increase in revenue compared with H1 FY2014. Furthermore, movements in the realised price of coal resulted in a decrease to revenue of US\$102 million. The realised price of hard coking coal and thermal coal decreased in H1 FY2015 by 22 per cent to US\$110 per tonne and 17 per cent to US\$57 per tonne respectively.

Underlying EBITDA increased by US\$50 million to US\$120 million in H1 FY2015. Volume-related cost variances were US\$129 million, resulting in a net volume-related decrease in Underlying EBITDA of US\$8 million. Cost efficiency savings were noted in raw materials, labour and contractors and mining costs resulting in an increase to Underlying EBITDA of US\$140 million. A stronger US dollar against the Australian dollar increased Underlying EBITDA by US\$9 million.

Underlying EBIT increased by US\$28 million from a loss of US\$8 million in H1 FY2014 to a profit of US\$20 million in H1 FY2015 in line with movements noted in Underlying EBITDA.

(2) Year ended 30 June 2014 compared with year ended 30 June 2013

Metallurgical coal production in FY2014 decreased by 10 per cent to 5,974 kt. The decrease was driven by an extended outage at the Dendrobium mine which impacted performance in the first half of FY2014.

Revenue in FY2014 was US\$878 million, a decrease of US\$409 million or 32 per cent from the corresponding period. The fall in raw coal production contributed to a US\$132 million decrease in revenue compared with FY2013. The primary driver of the decrease in coal revenue was a 22 per cent decrease in the average realised price of coking coal, which fell from US\$167 per tonne in FY2013 to US\$130 per tonne in FY2014. This movement in price had a US\$263 million negative impact on revenue.

Underlying EBITDA decreased by US\$167 million to US\$135 million in FY2014. Volume-related cost variances were US\$109 million, resulting in a net volume-related decrease in Underlying EBITDA of US\$23 million. A one off cost incurred in FY2013 and benefits from the sale of cheaper coal produced in FY2013 all contributed to cost efficiencies in FY2014 of US\$58 million. A stronger US dollar against the Australian dollar increased Underlying EBITDA by US\$78 million.

Underlying EBIT decreased by US\$189 million to a loss of US\$35 million in FY2014, compared with Underlying EBIT of US\$154 million in FY2013. This movement was primarily due to the decrease in Underlying EBITDA as well as additional depreciation due to an increased asset base following increased capital investment and mining activity at West Cliff and Appin, which all had a corresponding decrease to Underlying EBIT of US\$38 million.

(3) Year ended 30 June 2013 compared with year ended 30 June 2012

Illawarra Metallurgical Coal achieved record annual production in FY2013, with metallurgical production increasing to 6,664 kt. The increase in volumes was driven by increased capacity at West Cliff CPP and higher Dendrobium run-of-mine production.

Revenue in FY2013 was US\$1,287 million, a decrease of US\$414 million from US\$1,701 million in FY2012. Despite an increase in production volumes contributing to higher revenue of US\$252 million, the fall in average realised prices caused a more than offsetting decrease to revenue of US\$657 million. The decrease in metallurgical coal prices reflected deteriorating market conditions in FY2013 compared to FY2012. These conditions saw the average realised price for hard coking coal decrease to US\$167 per tonne compared with US\$255 per tonne, and thermal coal prices decrease to US\$79 per tonne compared with US\$101 per tonne.

Underlying EBITDA decreased by US\$516 million to US\$302 million from US\$818 million in FY2012. Volume-related cost variances were US\$152 million decrease to Underlying EBITDA, resulting in a net volume-related increase in Underlying EBITDA of US\$100 million. In addition a reduction in price-linked costs increased Underlying EBITDA by US\$31 million. Illawarra Metallurgical Coal achieved cost efficiencies totalling US\$58 million in the period, largely due to the favourable volume impact on operating cost efficiencies, partially offset by unfavourable inventory movements due to stockpile drawdowns.

Underlying EBIT decreased by US\$505 million to US\$154 million in FY2013, in line with the decrease in Underlying EBITDA offset by a reduction in depreciation of US\$11 million.

Table 11.23: Australia Manganese financial information

US\$M, unless otherwise stated	6 months ended December		12 months ended June		
	H1 FY2015	H1 FY2014	FY2014	FY2013	FY2012
Revenue	566	677	1,308	1,257	1,204
Underlying EBITDA	215	252	505	499	335
Underlying EBIT	162	216	414	436	282
Capital expenditure	57	58	108	271	213
Net operating assets	890	887	825	846	621
Production – manganese ore (kt)	2,499	2,438	4,776	5,027	4,306
Production – manganese alloy (kt)	139	123	269	234	198

(1) Half year ended 31 December 2014 compared with half year ended 31 December 2013

Manganese ore production increased three per cent in H1 FY2015 to 2,499 kt. Manganese alloy production increased by 13 per cent in H1 FY2015 to 139 kt compared to 123 kt in H1 FY2014.

Revenue in H1 FY2015 decreased by US\$111 million to US\$566 million. Despite the increase in production, lower sales volumes for ore resulted in an overall decrease to revenue of US\$39 million. Lower average realised prices of manganese ore fell 20 per cent to US\$185 per tonne; whereas realised average prices for manganese alloy rose 16 per cent to US\$1,140 per tonne. The overall impact of changes in realised prices was a decrease to revenue of US\$68 million.

Underlying EBITDA decreased by US\$37 million to US\$215 million in H1 FY2015. Volume-related cost savings of US\$12 million were noted in the period, with a net decrease of US\$27 million to Underlying EBITDA. The reduction in revenue noted above had a corresponding US\$32 million decrease in royalties and an increase in Underlying EBITDA. Cost savings in raw materials and a reduction in headcount and contractor related activities resulted in a US\$17 million increase to Underlying EBITDA. Furthermore, the strength of the US dollar against the Australian dollar contributed to a US\$10 million increase to Underlying EBITDA.

Underlying EBIT decreased by US\$54 million to US\$162 million in H1 FY2015. Non-cash movements of US\$18 million were noted in H1 FY2015, following the completion and capitalisation of the GEMCO Expansion Project.

(2) Year ended 30 June 2014 compared with year ended 30 June 2013

Manganese ore production declined five per cent in FY2014 to 4,776 kt as GEMCO was affected by higher than usual rainfall during the wet season. Manganese alloy production increased by 15 per cent in FY2014 compared to FY2013, which was affected by the temporary suspension of operations at TEMCO in FY2012.

Revenue in FY2014 increased by US\$51 million to US\$1,308 million. The decline in manganese ore production at GEMCO was more than offset by the increase in manganese alloy production at TEMCO resulting in a net increase to revenue of US\$101 million. Lower average realised prices of manganese ore and manganese alloy, which fell four per cent to US\$219 per tonne and down 20 per cent to US\$1,025 per tonne respectively, contributed to a decrease in revenue of US\$62 million.

Underlying EBITDA increased by US\$6 million to US\$505 million in FY2014. The impact of an overall increase in production and sales volume resulted in additional operating and royalty costs amounting to a total of US\$97 million. Inflationary pressures on operating costs resulted in a decrease to Underlying EBITDA of US\$15 million. This was more than offset by the strength of the US dollar against the Australian dollar, which contributed to a US\$72 million increase to Underlying EBITDA.

Underlying EBIT decreased by US\$22 million to US\$414 million in FY2014. Non-cash movements of US\$22 million were noted in FY2014, reflecting additional depreciation following the capitalisation of the GEMCO Expansion Project.

(3) Year ended 30 June 2013 compared with year ended 30 June 2012

Manganese ore production increased by 17 per cent to 5,027 kt in FY2013, benefiting from the completion of the GEMCO Expansion Project. The US\$167 million (South32 share) Expansion at GEMCO delivered first production during FY2013. The project increased processing capacity from 4.2 Mtpa to 4.8 Mtpa (100 per cent basis). Manganese alloy volumes ramped up in FY2013 to 234 kt, an increase of 18 per cent from FY2012, following the temporary suspension of operations at TEMCO in the corresponding period.

Revenue in FY2013 increased by US\$53 million or four per cent to US\$1,257 million in FY2013 from US\$1,204 million in FY2012. The increase in both ore and alloy production and sales volumes contributed to an increase in revenue of US\$74 million. Realised prices of manganese ore increased by eight per cent to US\$227 per tonne, but was partially offset by the seven per cent decline in realised prices of manganese alloy which fell to US\$1,282 per tonne, contributing to a US\$54 million increase in revenue, net of price-linked costs.

Underlying EBITDA increased by US\$164 million to US\$499 million in FY2013. The increase in profitability is largely due to unit cost reductions achieved at GEMCO and TEMCO. Cost efficiencies of US\$96 million were achieved through a reduction in operating cash costs for raw materials, mining consumables, labour and fuel and energy and from the dilution of fixed costs associated with mining processes as a result of increased production volumes.

Underlying EBIT increased by US\$154 million to US\$436 million in FY2013, in line with movements in Underlying EBITDA.

(h) South Africa Manganese

Table 11.24: South Africa Manganese financial information

US\$M, unless otherwise stated	6 months ended December		12 months ended June		
	H1 FY2015	H1 FY2014	FY2014	FY2013	FY2012
Revenue	386	350	788	856	932
Underlying EBITDA	63	21	120	111	(18)
Underlying EBIT	26	(9)	48	58	(51)
Capital expenditure	37	32	70	104	131
Net operating assets	802	813	790	845	786
Production – manganese ore (kt)	2,056	1,808	3,526	3,490	3,625
Production – manganese alloy (kt)	233	180	377	374	404

(1) Half year ended 31 December 2014 compared with half year ended 31 December 2013

Manganese volumes increased in H1 FY2015 compared with the corresponding period, with manganese ore volumes increasing 14 per cent to 2,056 kt and manganese alloy volumes increasing 29 per cent to 233 kt.

Revenue in H1 FY2015 was US\$386 million, a US\$36 million increase or 10 per cent, compared to US\$350 million in H1 FY2014. The volume-related impact to revenue was an increase of US\$87 million. Realised prices for manganese alloy declined three per cent to US\$911 per tonne. The realised price of manganese ore declined 16 per cent to US\$117 per tonne. The overall impact was a decrease to revenue of US\$32 million, net of price-linked costs.

Underlying EBITDA increased by US\$42 million to US\$63 million in H1 FY2015. Volume-related increases to operating costs were US\$75 million, resulting in a net volume-related increase in Underlying EBITDA of US\$12 million. Productivity and operating efficiencies resulted in an increase to Underlying EBITDA of US\$33 million. A stronger US dollar against the South African rand increased Underlying EBITDA by US\$42 million.

Underlying EBIT increased from a loss of US\$9 million in H1 FY2014 to a profit of US\$26 million in H1 FY2015. The increase in Underlying EBIT is consistent with movements noted in Underlying EBITDA.

(2) Year ended 30 June 2014 compared with year ended 30 June 2013

Manganese volumes in FY2014 remained fairly consistent compared with the corresponding period, with one per cent increases achieved in both ore and alloy volumes. Manganese ore volumes rose to 3,526 kt and manganese alloy volumes increased to 377 kt in FY2014.

Revenue in FY2014 was US\$788 million, a US\$68 million decrease or eight per cent, compared to US\$856 million in FY2013. The volume-related impact to revenue was a decrease of US\$35 million. Realised prices for both manganese ore and alloys decreased over the period, with manganese ore prices falling 15 per cent to US\$131 per tonne and manganese alloy prices falling five per cent to US\$990 per tonne. The overall impact was a decrease to revenue of US\$25 million, net of price-linked costs.

Underlying EBITDA increased by US\$9 million to US\$120 million in FY2014. Volume-related decreases to operating costs were US\$27 million, resulting in a net volume-related decrease in Underlying EBITDA of US\$8 million. This saving was partially offset by additional operating cash costs incurred due to unplanned shutdowns, which decreased Underlying EBITDA by US\$16 million. A stronger US dollar against the South African rand increased Underlying EBITDA by US\$108 million. In contrast, the impact of inflation on operating costs resulted in a decrease to Underlying EBITDA of US\$39 million.

Underlying EBIT decreased from US\$58 million to US\$48 million in FY2014. The decrease reflected the increase in Underlying EBITDA which was more than offset by an additional US\$19 million in depreciation expense as a result of capitalisation of large projects during the period.

(3) Year ended 30 June 2013 compared with year ended 30 June 2012

Manganese ore production decreased by four per cent to 3,490 kt in FY2013, following plant maintenance shutdowns at Mamatwan during the year. The permanent closure of energy-intensive SiMn production in January 2012 resulted in a seven per cent decline in the production of manganese alloys. Revenue in FY2013 decreased by US\$76 million or eight per cent to US\$856 million from US\$932 million.

The volume-related impact from movements in production on revenue amounted to a decrease of US\$28 million. Average realised prices for manganese ore rose 11 per cent to US\$154 per tonne. In contrast the average realised price of manganese alloys fell 12 per cent to US\$1,044 per tonne, resulting in a net decrease to revenue of US\$23 million.

Underlying EBITDA increased by US\$129 million in FY2013 to US\$111 million. Volume-related cost savings of US\$28 million offset the US\$28 million reduction in revenue due to lower sales volumes. Positive efficiencies were achieved through the production of manganese ore, which more than offset the closure impacts of the Metallurgy South Plant and furnace instabilities on operating costs for FY2013. The inflation impact on these efficiencies resulted in a decrease to Underlying EBITDA of US\$29 million. The permanent closure of the Metallurgy South Plant and the suspension of other minor capital projects resulted in a reduction to Underlying EBITDA of US\$49 million in FY2012, which was not noted in FY2013. In contrast, the weaker South African rand against the US dollar contributed to a US\$106 million increase to Underlying EBITDA.

Underlying EBIT increased by US\$109 million in FY2013 to US\$58 million from a loss of US\$51 million in the corresponding period. The increase reflected the increase in Underlying EBITDA offset by additional depreciation of US\$20 million.

(i) Cerro Matoso

Table 11.25: Cerro Matoso financial information

US\$M, unless otherwise stated	6 months ended December		12 months ended June		
	H1 FY2015	H1 FY2014	FY2014	FY2013	FY2012
Revenue	340	315	595	803	876
Underlying EBITDA	113	43	87	234	417
Underlying EBIT	86	1	(1)	155	337
Capital expenditure	18	35	56	50	105
Net operating assets	854	937	860	990	1,003
Production – nickel (kt)	21	24	44	51	49

(1) Half year ended 31 December 2014 compared with half year ended 31 December 2013

Nickel production at Cerro Matoso in H1 FY2015 declined 13 per cent to 21 kt as a result of lower nickel grades.

Revenue in H1 FY2015 was US\$340 million, an increase of US\$25 million, or eight per cent, from US\$315 million in the corresponding period. The average realised nickel price rose 28 per cent in the period to US\$16,190 per tonne, contributing to an increase in revenue of US\$72 million. Lower production driven by lower nickel grades resulted in a US\$46 million decrease in revenue.

Underlying EBITDA for H1 FY2015 increased by US\$70 million to US\$113 million. The volume-related cost impact of the decrease in production was US\$46 million, with a net nil volume-related impact to Underlying EBITDA. Savings of US\$12 million were noted in labour related costs following reductions to headcount. This was offset by increased mine operating costs and raw materials of US\$24 million due to the impact of lower nickel grades on plant utilisation and nickel recovery. In contrast, a stronger than average US dollar contributed to an increase in EBITDA of US\$10 million.

Underlying EBIT increased by US\$85 million to US\$86 million in H1 FY2015 driven by the increase in Underlying EBITDA and decrease in depreciation and amortisation of US\$15 million.

(2) Year ended 30 June 2014 compared with year ended 30 June 2013

Production at Cerro Matoso in FY2014 was affected by kiln and furnace outages, and lower nickel grades, causing a decrease in nickel production of 14 per cent to 44 kt compared with 51 kt in the corresponding period.

Revenue in FY2014 was US\$595 million, a decrease of US\$208 million, or 26 per cent, from US\$803 million in the corresponding period. Nickel prices fell 14 per cent in the period to US\$13,222 per tonne, contributing to a decrease in revenue of US\$46 million. Lower production driven by lower nickel grades and plant performance resulted in a US\$93 million decrease in revenue.

Underlying EBITDA for FY2014 decreased by US\$147 million to US\$87 million. The volume-related cost impact of the decrease in production was US\$80 million, with a net volume-related decrease in Underlying EBITDA of US\$13 million. A reduction in headcount resulted in higher redundancy-related costs of US\$19 million. Non-cash costs also increased in the period by US\$45 million, primarily driven by inventory adjustments following reserve restatements. These additional expenses contributed to a US\$76 million decrease in Underlying EBITDA. In contrast, a stronger than average US dollar contributed to an increase in EBITDA of US\$4 million.

Underlying EBIT decreased by US\$156 million to a loss of US\$1 million in FY2014, driven by the decrease in Underlying EBITDA and a US\$9 million increase in depreciation expense following revisions made to the underlying mine asset base.

(3) Year ended 30 June 2013 compared with 30 June 2012

Following the replacement of the line 1 furnace, nickel production at Cerro Matoso increased by four per cent to 51 kt.

Revenue in FY2013 was US\$803 million, a decrease of US\$73 million from FY2012. The decrease in revenue was primarily driven by lower realised nickel prices, which fell by 15 per cent to US\$15,442 per tonne, with a corresponding impact to revenue of US\$133 million. This decrease was partially offset by a US\$36 million increase to revenue due to the production volumes noted above.

Underlying EBITDA for FY2013 decreased by US\$183 million to US\$234 million. The decrease in revenue of US\$133 million due to lower realised prices had a corresponding impact on Underlying EBITDA. Higher production volumes noted above had a corresponding increase in costs of US\$22 million and a net volume-related increase in Underlying EBITDA of US\$14 million. Increases in operating costs contributed to a decrease in Underlying EBITDA of US\$34 million.

Underlying EBIT for FY2013 decreased by US\$182 million to US\$155 million in line with the decrease to Underlying EBITDA noted above.

(j) Cannington

Table 11.26: Cannington financial information

US\$M, unless otherwise stated	6 months ended December		12 months ended June		
	H1 FY2015	H1 FY2014	FY2014	FY2013	FY2012
Revenue	486	605	1,079	1,365	1,590
Underlying EBITDA	183	272	460	651	893
Underlying EBIT	154	251	413	611	840
Capital expenditure	14	30	60	39	73
Net operating assets	192	244	234	206	194
Production – lead (kt)	99	94	187	213	239
Production – zinc (kt)	37	32	58	56	55
Production – silver (koz)	12,235	12,667	25,161	31,062	34,208

(1) Half year ended 31 December 2014 compared with half year ended 31 December 2013

Lead and zinc production at Cannington increased in H1 FY2015 by five per cent to 99 kt and 16 per cent to 37 kt, respectively. Silver production decreased three per cent in the period to 12,235 koz compared with 12,667 koz in H1 FY2014.

Revenue in H1 FY2015 was US\$486 million, a decrease of US\$119 million, or 20 per cent, from US\$605 million in the corresponding period. Movements in the production of lead, zinc and silver resulted in an overall decrease to revenue of US\$46 million. Average realised prices of lead and silver both fell during the period; with lead falling 19 per cent to US\$1,950 per tonne and silver falling 15 per cent to US\$17 per tonne. These decreases were partially offset by a 19 per cent increase in the average realised price of zinc which rose to US\$2,273 per tonne. The overall impact of movements in realised prices was a US\$58 million decrease to revenue, net of price-linked costs.

Underlying EBITDA for H1 FY2015 fell by US\$89 million to US\$183 million from US\$272 million in H1 FY2014. The volume-related cost savings were US\$5 million, resulting in a net volume-related decrease in Underlying EBITDA of US\$41 million. Operating costs remained fairly consistent with the corresponding period, with no significant changes impacting results. A stronger US dollar against the Australian dollar resulted in a positive exchange variance of US\$7 million.

Underlying EBIT decreased by US\$97 million to US\$154 million in H1 FY2015, driven by the decrease in Underlying EBITDA and a US\$8 million increase in depreciation expense in line with the change in capital profile at Cannington.

(2) Year ended 30 June 2014 compared with year ended 30 June 2013

Lead and silver production at Cannington decreased in FY2014 by 12 per cent to 187 kt and 19 per cent to 25,161 koz, respectively. Zinc production increased slightly in the period to 58 kt compared to 56 kt in the corresponding period.

Revenue in FY2014 was US\$1,079 million, a decrease of US\$286 million, or 21 per cent, from US\$1,365 million in the corresponding period. Lower lead and silver production contributed to a decrease in revenue of US\$161 million, which was partially offset by the increase in zinc payable metals volume of US\$16 million. Lower average realised prices for silver, which fell 26 per cent to US\$20 per ounce, were partially offset by the increase in realised prices of lead and zinc, which rose 15 per cent to US\$2,344 per tonne and 12 per cent to US\$2,000 per tonne, respectively, resulting in a US\$122 million decrease in revenue, net of price-linked costs.

Underlying EBITDA for FY2014 decreased by US\$191 million to US\$460 million. Volume-related cost savings were US\$21 million, resulting in a net volume-related decrease in Underlying EBITDA of US\$124 million. Operating costs remained fairly consistent with the corresponding period, with no significant changes impacting results. A stronger US dollar against the Australian dollar resulted in a positive exchange variance of US\$57 million.

Underlying EBIT decreased by US\$198 million to US\$413 million in FY2014, driven by the decrease in Underlying EBITDA and a US\$7 million increase in depreciation expense associated with capital profile and useful life adjustments made during the period.

(3) Year ended 30 June 2013 compared with year ended 30 June 2012

Lead production decreased 11 per cent with silver production decreasing nine per cent, with silver falling from 34,208 koz to 31,062 koz and lead from 239 kt to 213 kt. Zinc production remained consistent across both periods.

Revenue in FY2013 was US\$1,365 million, a decrease of US\$225 million, or 14 per cent, from US\$1,590 million in FY2012. Lower production of lead and silver due to a combination of lower lead grades and lower plant throughput resulted in a corresponding decrease to revenue of US\$138 million. Average realised prices of silver and zinc fell 13 per cent to US\$27 per ounce and seven per cent to US\$1,787 per tonne respectively, partially offset by the eight per cent increase in the realised price of lead to US\$2,030 per tonne resulting in a net decrease in revenue of US\$109 million, net of price-linked costs.

Underlying EBITDA for FY2013 decreased by US\$242 million to US\$651 million. Savings in volume-related costs were US\$25 million resulting in a net volume-related decrease in Underlying EBITDA of US\$113 million. Labour-related productivity cost efficiencies increased Underlying EBITDA by US\$10 million, reflecting insourcing initiatives and the broader optimisation of contractor activities across South32. Furthermore, the inflation factor on operating costs resulted in a US\$11 million decrease to EBITDA.

Underlying EBIT decreased by US\$229 million to US\$611 million, driven by the decrease in Underlying EBITDA partially offset by reduced depreciation costs of US\$13 million following the change in accounting for a lease arrangement in the period from operating lease to finance lease.

11.7 THIRD PARTY SALES

South32 differentiates sales of its production from sales of third party products due to the significant difference in profit margin earned on these sales. The table below shows the breakdown between South32's production and third party products:

Table 11.27: Underlying EBIT and third party product margin

	6 months ended December		12 months ended June		
	H1 FY2015	H1 FY2014	FY2014	FY2013	FY2012
South32 production					
Revenue	4,636	4,572	9,182	10,430	11,476
Related operating costs	(3,866)	(4,090)	(8,141)	(9,339)	(9,644)
Underlying EBIT	770	482	1,041	1,091	1,832
Underlying EBIT margin	16.6%	10.5%	11.3%	10.5%	16.0%
Third party products					
Revenue	404	776	1,262	1,663	2,359
Related operating costs	(374)	(748)	(1,233)	(1,600)	(2,265)
Third party Underlying EBIT	30	28	29	63	94
Margin on third party products	7.4%	3.6%	2.3%	3.8%	4.0%

South32 engages in third party trading for the following reasons:

- production variability and occasional shortfalls from the South32 Businesses means that South32 sometimes sources third party materials to ensure a steady supply of product to its customers;
- to optimise its supply chain outcomes, South32 may buy physical product from third parties;
- in order to support the development of liquid markets, South32 will sometimes source third party physical product and manage risk through both the physical and financial markets.

11.8 CASH FLOW ANALYSIS

Full historical combined cash flow statements are contained in the historical combined financial information in Annexures 1 and 2. The explanatory notes appear in note 20 Notes to the combined cash flow statement to the historical combined financial information in Annexure 1. A summary table has been presented below to show the key sources and uses of cash.

Table 11.28: Cash flow

US\$M	6 months ended December		12 months ended June		
	H1 FY2015	H1 FY2014	FY2014	FY2013	FY2012
Cash generated from operations	1,131	781	2,108	2,138	2,899
Dividends received and net interest paid	252	(37)	(120)	(15)	36
Taxation paid	(134)	(251)	(318)	(697)	(542)
Net operating cash flows	1,249	493	1,670	1,426	2,393
Purchases of property plant and equipment	(411)	(394)	(769)	(1,139)	(2,013)
Exploration expenditure	(13)	(14)	(24)	(29)	(51)
Exploration expenditure expensed and included in operating cash flows	9	11	17	21	41
Purchases of intangibles	-	(1)	-	(20)	-
Investment in financial assets	(13)	(12)	(24)	(21)	(8)
Proceeds from sale of property, plant and equipment	6	11	48	64	-
Proceeds from financial assets	7	46	52	19	8
Net investing cash flows	(415)	(353)	(700)	(1,105)	(2,023)
Proceeds from interest bearing liabilities	7	235	251	2,274	74
Repayment of interest bearing liabilities	(103)	(463)	(456)	(112)	(366)
Proceeds from issue of shares	8,000	-	-	9	-
Deposit with BHP Billiton	(7,565)	-	-	-	-
Dividends paid	(661)	(343)	(505)	(2,296)	(79)
Dividends paid to non-controlling interests	(85)	(52)	(133)	(59)	(56)
Other financing activities	(327)	298	(116)	(107)	13
Net financing cash flows	(734)	(325)	(959)	(291)	(414)
Net increase/(decrease) in cash and cash equivalents	100	(185)	11	30	(44)

(a) Half year ended 31 December 2014 compared with half year ended 31 December 2013

Net operating cash flows after interest and tax increased by 153 per cent to US\$1,249 million for H1 FY2015. An increase in cash generated from operations of US\$350 million was the major contributor to the increase.

Net investing cash outflows increased by 18 per cent to US\$415 million. Purchases of property, plant and equipment in the period of US\$411 million were slightly higher than the previous period and related to minor and maintenance expenditure.

Net financing cash flows included the proceeds on the issue of shares to BHP Billiton of US\$8.0 billion to enable the acquisition of the companies that will comprise South32. During H1 FY2015, the proceeds were primarily placed on deposit with BHP Billiton. Dividend payments to BHP Billiton Group companies were US\$661 million, up from US\$343 million in the corresponding period.

(b) Year ended 30 June 2014 compared with year ended 30 June 2013

Net operating cash flows after interest and tax increased by 17 per cent to US\$1,670 million for FY2014. A US\$379 million reduction in taxation paid was the major contributor to the increase.

A US\$405 million reduction in net investing cash outflows to US\$700 million primarily reflects greater purchase of property, plant and equipment in FY2013 of US\$1,139 million related to assets under construction in conjunction with capital expenditure on asset sustaining activities.

Net financing cash flows included repayment of borrowings of US\$456 million and dividend payments of US\$505 million paid to BHP Billiton Group companies partially offset by proceeds from borrowings of US\$251 million.

(c) Year ended 30 June 2013 compared with year ended 30 June 2012

Net operating cash flows after interest and tax decreased by 40 per cent to US\$1,426 million for FY2013. A US\$761 million reduction in cash generated from operations (after changes in working capital balances) was the major contributor to the decline. Higher net income tax paid further reduced net operating cash flows after interest and tax by US\$155 million.

Investing cash flows decreased by US\$918 million, which primarily reflects greater purchase of property, plant and equipment in FY2012 of US\$2,013 million related to assets under construction in conjunction with capital expenditure on asset sustaining activities.

Net financing cash flows included proceeds from borrowings of US\$2,274 million offset by dividend payments of US\$2,296 million to BHP Billiton Group companies.

11.9 NET DEBT AND SOURCES OF LIQUIDITY

Historically, South32 has sourced debt and working capital requirements under the BHP Billiton centrally managed treasury function. The calculation of gearing based on the historical combined financial information is not meaningful in light of the proposed settlement of outstanding intercompany debt balances prior to the Demerger. The table below presents gearing based on South32's pro forma balance sheet as at 31 December 2014:

Table 11.29: Pro forma balance sheet, gearing^(a)

US\$M	31 December 2014
Cash and cash equivalents	(350)
Current external debt	282
Non-current external debt	742
Net debt	674
Net assets	12,950
Gearing	4.9%

(a) Current external debt, non-current external debt and net assets have been extracted without material adjustment from Table 10.5 in Section 10.7. Cash and cash equivalents excludes restricted cash of US\$14 million. Gearing is the ratio of net debt to net debt plus net assets.

(a) Capital management

On a pro forma basis, net debt, comprising interest bearing liabilities less cash and cash equivalents, was US\$674 million at 31 December 2014 (as sourced from Table 10.5 in Section 10.7). Gearing, which is the ratio of net debt to net debt plus net assets, was 4.9 per cent at 31 December 2014 based on the pro forma balance sheet.

Pro forma cash at bank and in hand at 31 December 2014 was US\$350 million. Included within this were short-term deposits at 31 December 2014 of US\$7 million. Restricted cash and cash equivalents of US\$14 million were excluded.

(b) Funding sources

Funding has historically been provided through BHP Billiton's centrally managed treasury function. Post-Demerger, South32 will source its own funding through long-term facilities and other methods as deemed appropriate. Further details on South32's anticipated funding structure can be found in Section 10.6.

(c) Quantitative and qualitative disclosures about market risk

South32's primary market risks are identified in Section 11.2. A description of how South32 manages its market risks, including both quantitative and qualitative information about its market risk sensitive instruments outstanding at 30 June 2014, is contained in note 23 Financial risk management to the historical combined financial information at Annexure 1.

This page has been intentionally left blank.

12 INDEPENDENT ACCOUNTANT'S ASSURANCE REPORT



KPMG Transaction Services

A division of KPMG Financial Advisory Services
(Australia) Pty Ltd
Australian Financial Services Licence No. 246901
147 Collins Street
Melbourne Vic 3000

ABN: 43 007 363 215
Telephone: +61 3 9288 5555
Facsimile: +61 3 9288 6666
DX: 30824 Melbourne
www.kpmg.com.au

GPO Box 2291U
Melbourne Vic 3001
Australia

Private and confidential

The Directors
South32 Limited
108 St Georges Terrace
Perth WA 6000

16 March 2015

Dear Directors

Independent Accountant's Assurance Report on the compilation of pro forma historical financial information and Financial Services Guide

Independent Accountant's Assurance Report

Introduction

We have been engaged by the directors of South32 Limited (the "Company" or "South32") to prepare this report on the compilation of Pro forma historical financial information of South32 in connection with the demerger of South32 from BHP Billiton Limited and BHP Billiton Plc (the "Demerger") and (1) the proposed primary listing of South32 on the Australian Securities Exchange (the "Australian Listing"), (2) the proposed secondary listing on the Johannesburg Stock Exchange (the "JSE Listing"), and (3) the proposed admission of the ordinary shares to listing on the standard segment of the Official List of the UKLA Financial Conduct Authority and to trading on the London Stock Exchange (the "UK Listing") (together the "Transaction").

The directors of South32 have prepared a single document dated on or about 16 March 2015 that will form the basis of:

- an Information Memorandum in respect of the Australian Listing (the "ASX listing document");
- a prospectus in respect of the UK Listing (the "UK Prospectus");
- a pre-listing statement in respect of the JSE Listing (the "JSE Pre-listing Statement").

The ASX listing document, the UK Prospectus and JSE Pre-listing Statement are together referred to as the "South32 Documents".

This report is intended to satisfy the requirements of paragraph 7 of Annex II of the Commission Regulation 809/2004/EC (the "Prospectus Directive Regulation") and is given for the purpose of complying with that paragraph.

KPMG Financial Advisory Services (Australia) Pty Ltd is affiliated with KPMG.

KPMG is an Australian partnership and a member firm of the KPMG network of independent member firms affiliated with KPMG International Cooperative ("KPMG International"), a Swiss entity.

Pro forma historical financial information

We have completed our assurance engagement to report on the South32 pro forma historical financial information, comprising the pro forma historical consolidated balance sheet as at 31 December 2014, summary pro forma historical consolidated income statements for the half year ended 31 December 2014 and financial year ended 30 June 2014, summary pro forma historical consolidated cash flow statements before financing activities and tax and after capital expenditure for the half year ended 31 December 2014 and financial year ended 30 June 2014, pro forma net indebtedness summary as at 31 December 2014 and pro forma segment financial information for the half year ended 31 December 2014 and the year ended 30 June 2014 as set out in Sections 10.3, 10.4, 10.5, 10.7, 10.8 and Annexures 3 and 4 of the South32 Documents (the “**Pro forma historical financial information**”).

The Pro forma historical financial information has been prepared and compiled by the directors of South32 on the basis stated in Section 10.2 of the South32 Documents, for illustrative purposes only, to provide information about how the: (1) events and transactions related to the Demerger; and (2) discontinued consolidation of the Manganese business and subsequent accounting for South32’s equity interest as an equity accounted joint venture, might have affected the historical financial information presented on the basis of the accounting policies adopted by South32 in preparing its historical combined financial information.

The historical combined financial information of South32 extracted by the directors of South32 from the Annexures 1 and 2 Historical combined financial information in compiling the Pro forma historical financial information was reviewed, for the half year ended 31 December 2014, and was audited for the financial year ended 30 June 2014. The historical combined financial information for the financial year ended 30 June 2014 was audited by KPMG in accordance with International Standards on Auditing and Australian Auditing Standards. The historical combined financial information for the half year ended 31 December 2014 was reviewed by KPMG in accordance with ISRE 2410 *Review of Interim Financial Information Performed by the Independent Auditor of the Entity* and ASRE 2410 *Review of a Financial Report Performed by the Independent Auditor of the Entity* as issued by the Australian Auditing and Assurance Standards Board. The independent audit report and review report issued to the Directors of South32 relating to this historical combined financial information was unmodified, however wording was added to emphasise the matter of basis of preparation.

Directors’ responsibilities for the Pro forma historical financial information

The directors of South32 are responsible for the preparation and compilation of the Pro forma historical financial information on the basis described in Section 10.2 of the South32 Documents, including the selection and determination of the pro forma adjustments made to the historical combined financial information and included in the Pro forma historical financial information and such basis being consistent with the accounting policies of South32.

The directors’ responsibility includes establishing and maintaining such internal controls as the directors determine are necessary to enable the preparation of Pro forma historical financial information that is free from material misstatement, whether due to fraud or error.

Our responsibility

It is our responsibility to form an opinion, as required by paragraph 7 of Annex II of the Prospectus Directive Regulation, about whether the Pro forma historical financial information has been compiled by the directors of South32 on the basis stated and such basis is consistent with the accounting policies of South32, and to report that opinion to you.

Basis of opinion

We have conducted our work in accordance with International Standard on Assurance Engagements (ISAE) 3420, *Assurance Engagements to Report on the Compilation of Pro Forma Financial Information Included in a Prospectus*, issued by the International Auditing and Assurance Standards Board. This standard requires that we comply with ethical requirements and plan and perform procedures to obtain reasonable assurance about whether the directors of South32 have compiled the Pro forma historical financial information on the basis stated.

In providing our report we are not responsible for updating, refreshing or re-issuing any audit reports or review reports previously made on any historical combined financial information used in the compilation or preparation of the Pro forma historical financial information, nor have we, in the course of this engagement, performed an audit or review of the financial information used in preparing the Pro forma historical financial information.

The purpose of the Pro forma historical financial information is to illustrate how the (1) events and transactions related to the Demerger; and (2) discontinued consolidation of the Manganese business and subsequent accounting for South32's equity interest as an equity accounted joint venture, might have affected the historical combined financial information.

Due to its nature, the Pro forma historical financial information does not represent South32's actual or prospective financial position, financial performance and/or cash flows. Accordingly, we do not provide any assurance that the actual outcome of the event or transaction at the dates stated would have been as presented.

A reasonable assurance engagement to report on whether the Pro forma historical financial information has been properly compiled on the basis stated involves performing procedures to assess whether the basis used by the directors of South32 in the compilation of the Pro forma historical financial information provides a reasonable basis for presenting the significant effects directly attributable to the Transaction and to obtain sufficient appropriate evidence about whether:

- the related pro forma adjustments give appropriate effect to the basis stated;
- the Pro forma historical financial information reflects the proper application of those pro forma adjustments to the unadjusted historical combined financial information.

The procedures selected depend on our judgment, having regard to our understanding of the nature of the Company, the Transaction in respect of which the Pro forma historical financial information has been compiled and other relevant engagement circumstances.

The engagement also involves evaluating the overall presentation of the Pro forma historical financial information.

We believe that the evidence we have obtained is sufficient and appropriate to provide a basis for our opinion.

Our work has not been carried out in accordance with auditing or other standards and practices generally accepted in the United States and accordingly should not be relied upon as if it had been carried out in accordance with those standards and practices.

Opinion

In our opinion:

- the Pro forma historical financial information has been properly compiled on the basis stated; and
- such basis is consistent with the accounting policies of South32.

Declaration for the purposes of the UK Prospectus

For the purposes of Prospectus Rule 5.5.3R (2)(f) of the Financial Conduct Authority we are responsible for this report as part of the UK Prospectus and declare that we have taken all reasonable care to ensure that the information contained in this report is, to the best of our knowledge, in accordance with the facts and contains no omission likely to affect its import. This declaration is included in the UK Prospectus in compliance with paragraph 1.2 of Annex I of the Prospectus Directive Regulation.

Independence

KPMG Transaction Services does not have any interest in the outcome of the proposed Transaction, other than in connection with the preparation of this report and participation in due diligence procedures for which normal professional fees will be received. KPMG is the auditor of BHP Billiton and South32 and from time to time, KPMG also provides BHP Billiton and South32 with certain other professional services for which normal professional fees are received.

General advice warning

This report has been prepared, and included in the South32 Documents, to provide investors with general information only and does not take into account the objectives, financial situation or needs of any specific investor. It is not intended to take the place of professional advice and investors should not make specific investment decisions in reliance on the information contained in this report. Before acting or relying on any information, an investor should consider whether it is appropriate for their circumstances having regard to their objectives, financial situation or needs.

Restriction on use

Without modifying our opinion, we draw attention to Sections 10.1 and 10.2 of the South32 Documents, which describe the purpose of the Pro forma historical financial information, included in the South32 Documents. As a result, the Pro forma historical financial information

South32 Limited
16 March 2015

may not be suitable for use for another purpose. We disclaim any assumption of responsibility for any reliance on this report, or on the Pro forma historical financial information to which it relates, for any purpose other than that for which it was prepared.

KPMG Transaction Services has consented to the inclusion of this report in the South32 Documents in the form and context in which it is included.

Accordingly, KPMG Transaction Services makes no representation regarding, and takes no responsibility for, any other statements, or material in, or omissions from, the ASX listing document, the UK Prospectus and the JSE Pre-listing Statement.

Yours faithfully



Nick Harridge
Authorised Representative



KPMG Transaction Services
A division of KPMG Financial Advisory Services
(Australia) Pty Ltd
Australian Financial Services Licence No. 246901
147 Collins Street
Melbourne Vic 3000

ABN: 43 007 363 215
Telephone: +61 3 9288 5555
Facsimile: +61 3 9288 6666
DX: 30824 Melbourne
www.kpmg.com.au

GPO Box 2291U
Melbourne Vic 3001
Australia

Financial Services Guide **Dated 16 March 2015**

What is a Financial Services Guide (FSG)?

This FSG is designed to help you to decide whether to use any of the general financial product advice provided by **KPMG Financial Advisory Services (Australia) Pty Ltd ABN 43 007 363 215**, Australian Financial Services Licence Number 246901 (of which KPMG Transaction Services is a division) (**'KPMG Transaction Services'**), and Nick Harridge as an authorised representative of KPMG Transaction Services, authorised representative number 405346 (**Authorised Representative**).

This FSG includes information about:

- KPMG Transaction Services and its Authorised Representative and how they can be contacted
- the services KPMG Transaction Services and its Authorised Representative are authorised to provide
- how KPMG Transaction Services and its Authorised Representative are paid
- any relevant associations or relationships of KPMG Transaction Services and its Authorised Representative
- how complaints are dealt with as well as information about internal and external dispute resolution systems and how you can access them;
- the compensation arrangements that KPMG Transaction Services has in place.

The distribution of this FSG by the Authorised Representative has been authorised by KPMG Transaction Services. This FSG forms part of an Independent Accountant's Assurance Report (**Report**) which has been prepared for inclusion in a disclosure document or, if you are offered a financial product for issue or sale, a Product Disclosure Statement (**PDS**). The purpose of the disclosure document or PDS is to help you make an informed decision in relation to a financial product. The contents of the disclosure document or PDS, as relevant, will include details such as the risks, benefits and costs of acquiring the particular financial product.

Financial services that KPMG Transaction Services and the Authorised Representative are authorised to provide

KPMG Transaction Services holds an Australian Financial Services Licence, which authorises it to provide, amongst other services, financial product advice for the following classes of financial products:

- deposit and non-cash payment products;
- derivatives;
- foreign exchange contracts;
- government debentures, stocks or bonds;

- interests in managed investments schemes including investor directed portfolio services;
- securities;
- superannuation;
- carbon units;
- Australian carbon credit units;
- eligible international emissions units,

to retail and wholesale clients. We provide financial product advice when engaged to prepare a report in relation to a transaction relating to one of these types of financial products. The Authorised Representative is authorised by KPMG Transaction Services to provide

KPMG Financial Advisory Services (Australia) Pty Ltd is affiliated with KPMG.

KPMG is an Australian partnership and a member firm of the KPMG network of independent member firms affiliated with KPMG International Cooperative ("KPMG International"), a Swiss entity.

financial product advice on KPMG Transaction Services' behalf.

KPMG Transaction Services and the Authorised Representative's responsibility to you

KPMG Transaction Services has been engaged by BHP Billiton Limited, BHP Billiton Plc (**BHP Billiton**) and South32 Limited (**South32**) (**Client**) to provide general financial product advice in the form of a Report to be included in ASX listing document (**Document**) prepared by BHP Billiton in relation to the proposed Demerger of South32, and listing on the Australian Securities Exchange (**Transaction**).

You have not engaged KPMG Transaction Services or the Authorised Representative directly but have received a copy of the Report because you have been provided with a copy of the Document. Neither KPMG Transaction Services nor the Authorised Representative are acting for any person other than the Client.

KPMG Transaction Services and the Authorised Representative are responsible and accountable to you for ensuring that there is a reasonable basis for the conclusions in the Report.

General advice

As KPMG Transaction Services has been engaged by the Client, the Report only contains general advice as it has been prepared without taking into account your personal objectives, financial situation or needs.

You should consider the appropriateness of the general advice in the Report having regard to your circumstances before you act on the general advice contained in the Report.

You should also consider the other parts of the Document before making any decision in relation to the Transaction.

Fees KPMG Transaction Services may receive and remuneration or other benefits received by our representatives

KPMG Transaction Services charges fees for preparing reports. These fees will usually be agreed with, and paid by, the Client. In this instance, BHP Billiton has agreed to pay KPMG Transaction Services time based fees of US\$1.9 million for preparing the Report and US\$7.3 million for other services provided relating to the Transaction.

KPMG Transaction Services and its officers, representatives, related entities and associates will not receive any other fee or benefit in connection with the provision of the Report.

KPMG Transaction Services officers and representatives (including the Authorised Representative) receive a salary or a partnership distribution from KPMG's Australian professional advisory and accounting practice (the **KPMG Partnership**). KPMG Transaction Services' representatives (including the Authorised Representative) are eligible for bonuses based on overall productivity. Bonuses and other remuneration and benefits are not provided directly in connection with any engagement for the provision of general financial product advice in the Report.

Further details may be provided on request.

Referrals

Neither KPMG Transaction Services nor the Authorised Representative pay commissions or provide any other benefits to any person for referring customers to them in connection with a Report.

Associations and relationships

Through a variety of corporate and trust structures KPMG Transaction Services is controlled by and operates as part of the KPMG Partnership. KPMG Transaction Services' directors and Authorised Representatives may be partners in the KPMG Partnership. The Authorised Representative is a partner in the KPMG Partnership. The financial product advice in the Report is provided by KPMG Transaction Services and the Authorised Representative and not by the KPMG Partnership.

From time to time KPMG Transaction Services, the KPMG Partnership and related entities (KPMG entities) may provide professional services, including audit, tax and financial advisory services, to companies and issuers of financial products in the ordinary course of their businesses.

KPMG entities have provided, and continue to provide, a range of audit and tax services to the Client for which professional fees are received. Over the past two financial years ended, professional fees of US\$57.1 million have been received from BHP Billiton. None of those services have related to the Transaction or alternatives to the Transaction.

No individual involved in the preparation of this Report holds a substantial interest in, or is a substantial creditor of, the Client or has other material financial interests in the Transaction.

Complaints resolution

Internal complaints resolution process

If you have a complaint, please let either KPMG Transaction Services or the Authorised Representative know. Formal complaints should be sent in writing to The Complaints Officer, KPMG, PO Box H67, Australia Square, Sydney NSW 1213. If you have difficulty in putting your complaint in writing, please telephone the Complaints Officer on 02 9335 7000 and they will assist you in documenting your complaint.

Written complaints are recorded, acknowledged within 5 days and investigated. As soon as practical, and not more than 45 days after receiving the written complaint, the response to your complaint will be advised in writing.

External complaints resolution process

If KPMG Transaction Services or the Authorised Representative cannot resolve your complaint to your satisfaction within 45 days, you can refer the matter to the Financial Ombudsman Service (**FOS**). FOS is an independent company that has been established to provide free advice and assistance to consumers to help in resolving complaints relating to the financial services industry.

Further details about FOS are available at the FOS website www.fos.org.au or by contacting them directly at:

Address: Financial Ombudsman Service Limited, GPO Box 3, Melbourne Victoria 3001

Telephone: 1300 78 08 08
Facsimile: (03) 9613 6399
Email: info@fos.org.au

The Australian Securities and Investments Commission also has a freecall infoline on 1300 300 630 which you may use to obtain information about your rights.

Compensation arrangements

KPMG Transaction Services has professional indemnity insurance cover as required by the Corporations Act 2001(Cth).

Contact details

You may contact KPMG Transaction Services or the Authorised Representative using the contact details:

KPMG Transaction Services
A division of KPMG Financial Advisory
Services (Australia) Pty Ltd
10 Shelley St
Sydney NSW 2000
PO Box H67
Australia Square
NSW 1213
Telephone: (02) 9335 7000
Facsimile: (02) 9335 7200

Nick Harridge
C/O KPMG
PO Box H67
Australia Square
NSW 1213
Telephone: (02) 9335 7000
Facsimile: (02) 9335 7200

13 TAXATION

13.1 IMPORTANT INFORMATION

Section 13 contains a general outline of the taxation implications of holding South32 Shares and South32 ADSs, for certain investors that are tax resident in Australia, New Zealand, the United Kingdom, the United States and South Africa.

This does not constitute tax advice. This document does not take into account South32 Shareholders' or South32 ADS holders' individual investment objectives, financial situation or needs. This outline is not a complete analysis of all taxation laws which may apply in relation to the holding of South32 Shares or South32 ADSs. All South32 Shareholders and South32 ADS holders should consult with their own independent taxation advisers regarding the taxation implications of holding South32 Shares or South32 ADSs given the particular circumstances which apply to them.

The taxation implications of participating in the Demerger of South32 are not addressed in this document.

Special rules may apply to certain shareholders such as tax exempt organisations, listed investment companies, insurance companies, superannuation funds, banks, South32 Shareholders who hold their South32 Shares as trading stock, South32 Shareholders and their associates that hold 10 per cent or more of the issued share capital in South32, South32 Shareholders (other than Australian tax residents) that use South32 Shares at any time in carrying on the business through an Australian permanent establishment, South32 Shareholders that hold shares as part of a straddle or a hedging or conversion transaction and South32 Shareholders who hold their South32 Shares in connection with an employee share scheme. This outline does not address any of the above circumstances or special rules and all South32 Shareholders and South32 ADS holders should consult with their own independent taxation advisers regarding the particular circumstances which apply to them.

This outline relates solely to matters governed by, and should be interpreted in accordance with, the laws of the various countries as in force and as interpreted at 9:00am (AEDT) on the date of this document. Future amendments to taxation legislation, or its interpretation by the courts or the taxation authorities may take effect retrospectively and/or affect the conclusions drawn. This outline does not take into account or anticipate changes in the law (by legislation or judicial decision) or practice (by ruling or otherwise) after that time.

13.2 AUSTRALIAN TAX CONSEQUENCES OF HOLDING SOUTH32 SHARES

(a) Scope

The following is a general outline of the main Australian taxation implications for South32 Shareholders who (i) are residents of Australia for income tax purposes (and are not tax residents of any other country), (ii) hold their South32 Shares on capital account for income tax purposes and (iii) are not subject to the rules concerning the taxation of financial arrangements contained in Division 230 of the Income Tax Assessment Act 1997 (Cth) in respect of their South32 Shares (**Australian South32 Shareholders**).

The Australian dividend withholding tax implications for South32 Shareholders that are not residents of Australia for income tax purposes are outlined in Section 13.2(c).

(b) Outline of Australian taxation implications of holding South32 Shares

(1) Dividends

Australian South32 Shareholders will be required to include dividends in respect of South32 Shares in their assessable income for the income year in which the dividends are received.

Dividends may be franked to the extent determined by South32. However, an Australian South32 Shareholder must be a 'qualified person' by satisfying the 'holding period rule', or qualifying for an exemption from that rule, to be entitled to the benefit of franking credits in respect of their South32 Shares.

South32's initial franking account balance and intention in respect of franking credits in the context of its dividend policy are set out in Section 5.5.

On the assumption that an Australian South32 Shareholder is a 'qualified person', the tax treatment of dividends received from South32 will be as follows:

- **Individuals:** Dividends and any franking credits will be included in the individual's assessable income. A tax offset for the amount of the franking credits will be available to reduce the tax payable by the individual. Any excess tax offset (i.e. to the extent it exceeds income tax payable by the individual) may be refundable to the individual.

- **Companies:** Dividends and any franking credits will be included in the company's assessable income. A tax offset for the amount of the franking credits will be available to reduce the tax payable by the company. Excess franking credits for the year may be converted to a deemed tax loss. A company that is a franking entity may be able to credit its franking account with the franking credits attached to dividends, which may enable the company to pay franked dividends to its own shareholders.
- **Trustees (excluding trustees of complying superannuation funds):** If Australian resident beneficiaries of a trust are presently entitled to a distribution of the net income of the trust for the year in which the dividend is derived by the trust, generally the franked dividend should flow through to, and be taxable in the hands of, the beneficiaries in accordance with their particular tax status and profile (subject to the trust having positive net income and the beneficiaries also satisfying the qualified person rule referred to above).

(2) Sale of shares

Australian South32 Shareholders will need to consider the capital gains tax (CGT) implications of any subsequent disposal of South32 Shares.

A capital gain will arise to the extent the capital proceeds from the disposal of the South32 Shares exceed the cost base of the shares sold.

A capital loss will be incurred to the extent the capital proceeds are less than the reduced cost base of the shares held by an Australian South32 Shareholder. A capital loss may be offset against other capital gains of the Australian South32 Shareholder arising in the same tax year, or otherwise carried forward and offset against capital gains realised in the future (subject to satisfaction of loss recoupment tests for certain taxpayers).

Any capital gain or capital loss on the disposal of South32 Shares deemed to have been acquired before 20 September 1985 will be disregarded.

Australian South32 Shareholders who are individuals or trustees of trusts (other than a trust that is a complying superannuation fund) may be entitled to discount the amount of their capital gain from the disposal of South32 Shares (after taking into account current year or carry forward capital losses) by 50 per cent if the disposal by the Australian South32 Shareholder is of shares they acquired, or are deemed to have acquired, at least 12 months before the disposal.

Although trustees of trusts may be entitled to the above CGT discount, special rules apply in respect of beneficiaries of such trusts. Australian South32 Shareholders that are trustees should consult with their own independent tax advisers regarding the income tax implications of distributions attributable to discount capital gains.

Australian South32 Shareholders that are companies (not acting as trustees) will not be entitled to the CGT discount.

Alternatively, Australian South32 Shareholders who acquired, or are deemed to have acquired, South32 Shares prior to 21 September 1999 may choose to adjust the cost base of their shares to include indexation (by reference to changes in the Consumer Price Index) from the calendar quarter in which the shares were acquired until the quarter ended 30 September 1999 (instead of applying the CGT discount).

Australian South32 Shareholders should seek their own advice to confirm whether there are any stamp duty consequences arising to them from a future disposal of South32 Shares.

(3) Goods and services tax (GST)

The sale or other disposition by Australian South32 Shareholders of South32 Shares will not be subject to GST in Australia.

(c) Australian dividend withholding tax

Dividends paid by South32 to its non-Australian shareholders will not be subject to Australian withholding tax to the extent that such dividends are declared by South32 to be franked dividends or conduit foreign income. South32 will advise shareholders when paying any dividends the extent to which (if any) the dividends are subject to Australian withholding tax.

If Australian dividend withholding tax is payable on dividends from South32, South32 Shareholders who are not tax resident in Australia should seek their own tax advice to determine the Australian and foreign taxation implications.

13.3 UNITED KINGDOM TAX CONSEQUENCES OF HOLDING SOUTH32 SHARES

(a) Scope

The following is a general outline of the main United Kingdom taxation implications for South32 Shareholders who (i) are resident in (and only in) and, in the case of individuals, domiciled in, the United Kingdom for United Kingdom tax purposes and to whom split-year treatment does not apply, (ii) will hold their South32 Shares as investments (other than under an individual savings account) and (iii) will be the beneficial owner of their South32 Shares and any dividends paid on them (**United Kingdom South32 Shareholders**).

(b) United Kingdom tax implications of holding South32 Shares: taxation of dividends

(1) Individual United Kingdom South32 Shareholders within the charge to United Kingdom income tax

An individual United Kingdom South32 Shareholder who receives a dividend from South32 will generally be entitled to a tax credit, which may be set off against their total income tax liability. The tax credit will equal 10 per cent of the aggregate of the dividend declared and the tax credit, which is also equal to one ninth of the amount of the dividend. For such South32 Shareholders eligible for this tax credit, this will have the effect of reducing the effective rate of United Kingdom income tax on the amount of the dividend declared to zero (for individuals taxable at the dividend ordinary rate), 25 per cent (for individuals taxable at the dividend upper rate) or 30.56 per cent (for individuals taxable at the dividend additional rate), subject in the latter two cases to any available credit for Australian dividend withholding tax.

(2) Corporate United Kingdom South32 Shareholders within the charge to United Kingdom corporation tax

United Kingdom South32 Shareholders within the charge to United Kingdom corporation tax which are 'small companies' for the purpose of United Kingdom taxation of dividends will not generally be subject to United Kingdom corporation tax on dividends received from South32. Other United Kingdom South32 Shareholders within the charge to United Kingdom corporation tax will not be subject to United Kingdom corporation tax on dividends received from South32 so long as the dividends fall within an exempt class and certain conditions are met and the shareholder has not elected for the dividends not to be exempt. For example, dividends paid on shares that (i) do not carry any present or future preferential right to dividends or to assets on a winding-up and (ii) are not redeemable, and dividends paid to a person holding less than 10 per cent of the issued share capital of South32 (or any class of that share capital), are generally dividends that fall within an exempt class.

(3) No payment of tax credit

A United Kingdom South32 Shareholder (whether an individual or a company) that is not liable to tax on dividends from South32 will not be entitled to claim payment of the tax credit in respect of those dividends.

(c) United Kingdom tax implications of holding South32 Shares: taxation of chargeable gains

(1) Individual United Kingdom South32 Shareholders

A disposal of South32 Shares by an individual United Kingdom South32 Shareholder may, depending on the circumstances and subject to any available exemption or relief, give rise to a chargeable gain (or allowable loss). Capital gains tax is charged on chargeable gains at a rate of 18 per cent or 28 per cent depending on the individual United Kingdom South32 Shareholder's total taxable gains and income in a given year, including any gains made on the disposal of the South32 Shares.

No indexation allowance will be available to an individual United Kingdom South32 Shareholder in respect of any disposal of South32 Shares.

However, each individual has an annual exemption (£11,000 for the tax year 2015-2016) such that capital gains tax is only chargeable on gains arising from all sources during the tax year in excess of that figure.

(2) Corporate United Kingdom South32 Shareholders

For a corporate United Kingdom South32 Shareholder within the charge to United Kingdom corporation tax, a disposal of South32 Shares may, depending on the circumstances and subject to any available exemption or relief, give rise to a chargeable gain (or allowable loss). An indexation allowance may be available to reduce the amount of the chargeable gain which would otherwise arise on the disposal. Corporation tax is charged on chargeable gains at the rate of corporation tax applicable to that company.

(3) United Kingdom stamp duty and United Kingdom stamp duty reserve tax

No United Kingdom stamp duty will be payable in respect of the paperless transfer of South32 Shares.

No United Kingdom stamp duty will be payable on a written transfer of South32 Shares if such transfer is executed and retained outside the United Kingdom and provided that such transfer does not relate to any property situated in the United Kingdom or to any other matter or thing done or to be done in the United Kingdom.

No United Kingdom stamp duty reserve tax will arise in respect of any transfer of, or agreement to transfer, the South32 Shares.

13.4 UNITED STATES FEDERAL INCOME TAX CONSEQUENCES OF HOLDING SOUTH32 SHARES OR SOUTH32 ADSs

(a) Scope

The following is a general outline of certain United States federal income tax consequences for South32 Shareholders and South32 ADS holders who (i) are a citizen or resident of the United States, a United States domestic corporation, or otherwise subject to United States federal income tax on a net income basis with respect to income from the South32 Shares or South32 ADSs, (ii) hold South32 Shares or South32 ADSs as capital assets for United States federal income tax purposes, (iii) are the beneficial owner of South32 Shares or South32 ADSs, and (iv) have as their functional currency the US dollar (**US South32 Holders**).

(b) Ownership of the South32 Shares or South32 ADSs

(1) General

Section 13.4(b) deals with certain United States federal income tax consequences to US South32 Holders of holding shares (or ADSs) of South32.

For this purpose, holders of ADSs will be treated for United States federal income tax purposes as holding the shares (as applicable) represented by the ADSs. Accordingly, no gain or loss will be recognised upon the exchange of South32 Shares for South32 ADSs (and vice versa).

(2) Dividends

A US South32 Holder must include in its gross income, the gross amount of any distribution South32 pays out of its current or accumulated earnings and profits (as determined for United States federal income tax purposes) as a dividend. Subject to certain exceptions for short-term and hedged positions, a non-corporate US South32 Holder of South32 Shares or South32 ADSs will generally be subject to tax on any distribution to the extent it is treated as a dividend at the rate applicable to long-term capital gains, provided that (i) South32 is eligible for the benefits of a comprehensive income tax treaty with the United States that the Internal Revenue Service (**IRS**) has approved under the qualified dividend rules and (ii) South32 is not a passive foreign investment company (**PFIC**) in the taxable year of the dividend or in the immediate preceding taxable year. South32 expects that it will be eligible for benefits under an applicable treaty. As discussed in Section 13.4(b)(4), South32 does not believe that it is a PFIC in its current taxable year or was a PFIC in the most recently ended taxable year, and does not expect to become a PFIC in the foreseeable future. In the case of a corporate US South32 Holder, dividends will not be eligible for the dividends received deduction generally allowed to United States corporations in respect of dividends received from US domestic corporations.

Distributions in excess of current and accumulated earnings and profits, as determined for US federal income tax purposes, will be treated as a non-taxable return of capital to the extent of the US South32 Holder's tax basis, determined in US dollars, in the South32 Shares or South32 ADSs and thereafter as a capital gain.

The amount of any cash distribution paid in any foreign currency will be equal to the United States dollar value of such currency, calculated by reference to the spot rate in effect on the date such distribution is received, regardless of whether and when the foreign currency is in fact converted into US dollars. If the foreign currency is converted into US dollars on the date received, the US South32 Holder generally should not recognise a foreign currency gain or loss on such conversion. If the foreign currency is not converted into US dollars on the date received, the US South32 Holder will have a tax basis in the foreign currency equal to its US dollar value on the date received, and generally will recognise a foreign currency gain or loss on a subsequent conversion or other disposal of such currency. Such foreign currency gain or loss generally will be treated as US source ordinary income or loss.

(3) Sales or disposition of South32 Shares or ADSs

Provided that South32 is not a PFIC, a US South32 Holder that sells or otherwise disposes of shares or ADSs will recognise a capital gain or loss for US federal income tax purposes equal to the difference between the US dollar value of the amount realised and the US South32 Holder's tax basis, determined in US dollars, in those shares or ADSs.

The gain or loss will generally be income or loss from sources within the United States for foreign tax credit limitation purposes. The capital gain of a non-corporate US South32 Holder is generally taxed at preferential rates where the US South32 Holder has a holding period greater than one year in the shares or ADSs sold. There are limitations on the deductibility of capital losses.

The US dollar value of any foreign currency received upon a sale or other disposition of shares or ADSs will be calculated by reference to the spot rate in effect on the date of sale or other disposal (or, in the case of a cash basis or electing accrual basis taxpayer, on the settlement date). A US South32 Holder will have a tax basis in the foreign currency received equal to that US dollars amount, and generally will recognise a foreign currency gain or loss on a subsequent conversion or other disposal of the foreign currency. This foreign currency gain or loss generally will be treated as United States source ordinary income or loss.

(4) Passive Foreign Investment Company

Based on South32's current expectations regarding the value and nature of its assets and the sources and nature of its income, South32 does not expect that it will be classified as a PFIC for United States federal income tax purposes for its current taxable year or its most recently ended taxable year. South32 is expected to continue to operate its business in such a manner that it is not expected to become a PFIC in the foreseeable future. However, there can be no assurance in this regard because the determination as to whether an entity is a PFIC must be made annually. Accordingly, there can be no assurance that South32 will not be considered a PFIC for any taxable year. US South32 Holders should consult their own tax advisers regarding the application of the PFIC rules to South32 and the implications of these rules for their particular circumstances.

(c) Information reporting and backup withholding

In general, dividends and payments of the proceeds from the sale, exchange or other disposition of shares, paid within the United States or through certain United States-related financial intermediaries to a United States person are subject to information reporting and may be subject to backup withholding unless the holder establishes that it is a corporation or other exempt recipient or, in the case of backup withholding, provides an accurate taxpayer identification number and certifies under penalty of perjury that it is a United States person and that it is not subject to backup withholding. Backup withholding is not an additional tax. A holder generally may obtain a refund of any amounts withheld under the backup withholding rules in excess of such holder's United States federal income tax liability by filing a refund claim with the IRS.

13.5 SOUTH AFRICAN TAX CONSEQUENCES OF HOLDING SOUTH32 SHARES

(a) Scope

The following is a general outline of the main South African taxation implications for South32 Shareholders that (i) are resident in (and only in) South Africa for South African tax purposes (ii) will hold their South32 Shares on capital account as investments for income tax purposes and (iii) will be the beneficial owners of South32 Shares and any dividends paid on them (**SA South32 Shareholders**).

(b) Outline of South African taxation implications of holding South32 Shares

(1) Dividends

A SA South32 Shareholder will be subject to South African dividends tax on any cash dividends paid in respect of the JSE listed South32 Shares.

(A) Individual SA South32 Shareholders

An individual SA South32 Shareholder will be subject to 15 per cent South African dividends tax on any cash dividends paid in respect of the JSE listed South32 Shares.

(B) Corporate SA South32 Shareholders

A corporate SA South32 Shareholder will be exempt from South African dividends tax on any cash dividends paid in respect of the JSE listed South32 Shares if such corporate has provided the required declaration and written undertaking to the relevant regulated intermediary within the required period.

(2) Disposal of South32 Shares

The subsequent disposal of South32 Shares by SA South32 Shareholders will be subject to CGT.

A capital gain will arise to the extent that the proceeds from the disposal of the shares exceed the cost base of the shares held by a SA South32 Shareholder.

A capital loss will arise to the extent that the proceeds from the disposal of the shares are less than the base cost of the shares held by a SA South32 Shareholder. A capital loss may be offset against any other capital gains of the SA South32 Shareholder. There is no limitation on the roll forward of capital losses.

(A) Individual SA South32 Shareholders

An individual SA South32 Shareholder will calculate a taxable capital gain (which will be included in their taxable income), or an assessed capital loss (which will be carried forward to the following year of assessment for set-off against future capital gains), as follows:

- the sum of all capital gains and losses that arose during the year of assessment less the exclusion of ZAR30,000 per annum less the assessed capital loss brought forward from a previous year of assessment;
- a total of 33.3 per cent of the taxable capital gain will be included in the taxable income of the individual SA South32 Shareholder on which they will be taxed at the individual's tax rate. The tax rate of an individual SA South32 Shareholder ranges between 18 to 40 per cent. The effective tax rate of the taxable capital gain of an individual SA South32 Shareholder will range between six per cent and 13.3 per cent.

(B) Corporate SA South32 Shareholders

A corporate SA South32 Shareholder will determine its taxable capital gain (or assessed capital loss) for a specific year of assessment in the same manner as an individual SA South32 Shareholder except that there is no annual exclusion available to a corporate SA South32 Shareholder.

66.6 per cent of the taxable capital gain will be included in the taxable income of the corporate SA South32 Shareholder on which they will be taxed at the corporate tax rate of 28 per cent. The effective tax rate of the taxable capital gain of a corporate SA South32 Shareholder amounts to 18.65 per cent.

13.6 NEW ZEALAND TAX CONSEQUENCES OF HOLDING SOUTH32 SHARES

(a) Scope

The following is a general outline of the main New Zealand taxation implications of holding South32 Shares for South32 Shareholders who are residents of New Zealand for income tax purposes (**New Zealand South32 Shareholders**).

(b) Outline of New Zealand taxation implications of holding South32 Shares

(1) Dividends

Dividends received by New Zealand South32 Shareholders in relation to their South32 Shares will be taxable income for New Zealand tax purposes and will need to be included in a tax return as assessable income for the income year in which the dividend is received. If dividends are paid in a currency other than New Zealand dollars, New Zealand South32 Shareholders will need to convert the dividend amount into New Zealand dollars in accordance with a prescribed method for the purposes of inclusion in their tax returns.

Any Australian franking credits attached to the dividends in relation to their South32 Shares under Australia's franking credit system will not be able to be used by New Zealand South32 Shareholders for the purposes of satisfying their New Zealand income tax liability. New Zealand South32 Shareholders may, however, receive a credit against their New Zealand income tax liabilities in respect of the dividends for any Australian dividend withholding tax deducted from those dividends.

(2) Sale of shares

New Zealand does not have a generic capital gains tax. However, New Zealand South32 Shareholders may be subject to New Zealand income tax on gains made on the sale or other disposal of South32 Shares or allowed a deduction for a loss sustained, in certain circumstances.

Generally, a New Zealand South32 Shareholder will be subject to income tax on a gain (or allowed a deduction for a loss) arising from the sale or disposal of South32 Shares if the New Zealand South32 Shareholder is in the business of dealing in shares, or disposes of the South32 Shares as part of a profit-making undertaking or scheme, or acquires the South32 Shares with the dominant purpose of selling them. New Zealand South32 Shareholders will need to consider their individual circumstances at the relevant time to determine whether any gain on the sale or disposal of South32 Shares will be taxable to them, or loss deductible, for tax purposes.

If any gain on disposal of South32 Shares is taxable (or loss deductible) to a New Zealand South32 Shareholder, the taxable gain (or deductible loss) will be the difference between the cost base for that New Zealand South32 Shareholder in the South32 Shares and the amount received for their disposal.

New Zealand South32 Shareholders will need to convert the amount of the gain (or loss) into New Zealand dollars in accordance with a prescribed method for the purposes of inclusion in their income tax returns.

(c) Goods and services tax (GST)

The sale or other disposal by New Zealand South32 Shareholders of South32 Shares will not be subject to GST in New Zealand.

14 INFORMATION ON THE DEMERGER

14.1 INTRODUCTION

The BHP Billiton Board announced its intention to separate the BHP Billiton Group into two businesses on 19 August 2014. The separation will be effected by way of a demerger. The Demerger will result in the formation of an independent listed company, South32, with a portfolio of assets producing alumina, aluminium, coal, manganese, nickel, silver, lead and zinc.

If the Demerger proceeds, BHP Billiton Shareholders' investment in BHP Billiton will be divided into separate investments in two listed entities – BHP Billiton and South32. South32 will apply for admission of its ordinary shares to trading on the ASX, JSE and LSE and will establish an over-the-counter ADS program in the United States, and will be headquartered in Perth, Australia.

Details regarding implementation of the Demerger are set out in the Shareholder Circular.

Section 14 focuses on certain aspects of the Demerger that will have ongoing relevance for South32.

14.2 INTERNAL RESTRUCTURE

To establish South32 as the owner of the South32 Businesses, a number of internal share and asset transfers and other commercial arrangements have been, or will be, implemented within the BHP Billiton Group in connection with the Demerger. The objective of the Internal Restructure is to ensure that South32 owns all the companies, assets, rights and operating liabilities relating to the South32 Businesses and BHP Billiton owns all the companies, assets, rights and liabilities relating to the BHP Billiton Businesses.

The key elements of the Internal Restructure are as follows:

- entities and assets and liabilities relating to the South32 Businesses have been or will be transferred to the South32 Group and entities and assets and liabilities relating to the BHP Billiton Businesses have been transferred out of the South32 Group;
- certain persons previously employed by the BHP Billiton Group who work for the South32 Businesses have been or will be offered continuing employment with the South32 Group. Apart from the identity of the entity that employs the relevant employees, their terms and conditions of employment are or will be substantially similar to their current terms and conditions of employment;
- intercompany loans between members of the South32 Group and the BHP Billiton Group have been or will be extinguished.

In order to give effect to the share and asset transfers forming part of the Internal Restructure, a series of share and asset sale agreements were entered into between members of the BHP Billiton Group and members of the South32 Group. These sale agreements are on standard terms for intra-group share and asset sales, including limited title and capacity warranties given by both parties. Although the majority of the transfers contemplated by the sale agreements have already been completed as at the date of this document, completion under a limited number of the sale agreements remains conditional on BHP Billiton Shareholder approval being obtained for the Demerger. In addition, BHP Billiton Plc and South32 have entered into a Subscription Agreement (**Subscription Agreement**) under which, on the Distribution Date, South32 will issue to BHP Billiton Plc (or a subsidiary it nominates) a number of South32 Shares equal to the number of BHP Billiton Plc Shares on issue on the Plc Record Date. The subscription amount payable for each South32 Share will be the VWAP of South32 Shares traded on the ASX over the five trading days from the ASX Listing Date.

Not all of the transactions underlying the Internal Restructure have been entered into or effected on the same terms as could have been obtained from third parties. In particular, agreements for the transactions underlying the Internal Restructure have not included terms such as warranties that might have been obtained from third parties. This reflects the nature of the Demerger (which is unlike a sale to a third party) and the desire of the BHP Billiton Board to allocate the risks and benefits between the South32 Group and the BHP Billiton Group appropriately.

14.3 IMPLEMENTATION OF THE DEMERGER

In summary, implementation of the Demerger involves:

- an in-specie distribution of South32 Shares by BHP Billiton Limited and BHP Billiton Plc to Eligible Shareholders, which is expected to be implemented on 24 and 25 May 2015 respectively;
- the South32 Shares that would have otherwise been distributed to Ineligible Overseas Shareholders will be transferred to the Sale Agent. The Sale Agent will sell these South32 Shares, and the South32 Shares received initially by the Selling Shareholders, on the ASX and the net proceeds are to be paid to the Ineligible Overseas Shareholders and the Selling Shareholders.

South32 will apply for admission of its ordinary shares to trading on the ASX, JSE and LSE. Trading in South32 Shares is expected to commence on 18 May 2015 on the ASX, initially on a deferred settlement basis, and on the LSE, on a when-issued basis. Normal trading is expected to commence on the ASX on 2 June 2015, JSE on 18 May 2015 and LSE on 26 May 2015. Further information is set out in the Shareholder Circular.

14.4 DEMERGER AGREEMENTS

The key transaction documents to give effect to the Demerger are summarised below.

(a) Implementation Deed

The Implementation Deed entered into on or around the date of this document between BHP Billiton Limited, BHP Billiton Plc and South32 sets out:

- the conditions to the Demerger, which are described in Section 7.1 of the Shareholder Circular;
- certain steps required to be taken by each party to implement the Demerger.

(b) Separation Deed

The Separation Deed entered into on or around the date of this document between BHP Billiton Limited, BHP Billiton Plc and South32 deals with issues arising in connection with the separation of South32 from the BHP Billiton Group.

The key terms of the Separation Deed are summarised below:

- **Demerger Principle:** Subject to certain exceptions (see below), the fundamental underlying principle of the Demerger (**Demerger Principle**) is that:
 - the South32 Group will have the entire economic benefit and risk of the South32 Businesses (and former South32 Businesses), as if the South32 Group and not the BHP Billiton Group had owned those businesses at all times;
 - the BHP Billiton Group will have the entire economic benefit and risk of the BHP Billiton Businesses (including the entire risk in former BHP Billiton Businesses), as if the BHP Billiton Group and not the South32 Group had owned those businesses at all times.

This principle is subject to BHP Billiton being entitled to all the cash of the South32 Businesses up to the Economic Separation Date, so long as the South32 Group has net cash (broadly defined as cash and cash equivalents less interest bearing liabilities but excluding financing leases) of US\$54 million (subject to certain other agreed adjustments) at the time of its separation from the BHP Billiton Group.

- **Rights and obligations in accordance with the Demerger Principle:** To give effect to the Demerger Principle, BHP Billiton and South32 agree that once the Demerger is implemented, no member of the BHP Billiton Group will have any rights against, or obligations to, any member of the South32 Group and no member of the South32 Group will have any rights against, or obligations to, any member of the BHP Billiton Group.

This is subject to exceptions, including in relation to the rights and obligations of the BHP Billiton Group and the South32 Group under:

- the Separation Deed and other transaction documents;
 - insurance policies issued or underwritten by a member of the BHP Billiton Group;
 - certain other agreements between the BHP Billiton Group and the South32 Group that the parties have agreed will continue following the Distribution Date.
- **Assumption of liabilities:** Consistent with the Demerger Principle:
 - BHP Billiton will assume and be responsible for all liabilities relating to the BHP Billiton Businesses and former BHP Billiton Businesses (howsoever arising) and BHP Billiton Limited indemnifies the South32 Group against all claims and liabilities relating to those businesses (separate indemnities also apply under some of the sale agreements relating to the Internal Restructure);
 - South32 will assume and be responsible for all liabilities relating to the South32 Businesses and former South32 Businesses (howsoever arising) and indemnifies the BHP Billiton Group against all claims and liabilities relating to those businesses (separate indemnities also apply under some of the sale agreements relating to the Internal Restructure);
 - the Separation Deed also includes specific provisions concerning tax liabilities which are described below.

- **Release:** To support the points described above, BHP Billiton and South32 have agreed that:
 - South32 releases BHP Billiton from liabilities relating to the existing and former South32 Businesses and BHP Billiton releases South32 from liabilities relating to existing and former BHP Billiton Businesses;
 - BHP Billiton and South32 have no right to make any claim against each other and release each other from any liability relating to:
 - the matters and transactions which are the subject of, or contemplated by, the Separation Deed and other transaction documents;
 - the Internal Restructure (and the various transfers of ownership and responsibility undertaken pursuant to it);
 - the Demerger;
 - any express or implied conduct or representations made by them or certain of their representatives in the course of communications or negotiations about those matters,
 except as expressly provided for in, or in relation to a breach of, the Separation Deed, another transaction document, insurance policies issued or underwritten by a member of the BHP Billiton Group, certain other agreements between the BHP Billiton Group and the South32 Group that the parties have agreed will continue following the Distribution Date and any claims and liabilities that cannot be excluded by law.
- **Limitations and exclusions from indemnities and claims:** BHP Billiton and South32 may only make a claim (including in relation to any of the indemnities described in this Section 14.4(b)) under the Separation Deed or another transaction document if the amount of the claim exceeds US\$100,000. In addition, the claim must be net of any amount that the party receives under insurance. A party is not liable for a claim made by the other under the Separation Deed or any other transaction document to the extent the liability giving rise to the claim arises from the fraud, wilful misconduct or bad faith of the claiming party.
- **Assets:** If, following the Distribution Date, any asset which exclusively relates to a South32 Business or any minerals tenement which is held for the primary purpose or benefit of a South32 Business is identified as being owned by the BHP Billiton Group then, subject to certain limitations and qualifications, the Separation Deed imposes obligations on BHP Billiton to transfer, assign or grant rights over that asset or tenement to the South32 Group. Reciprocal obligations apply to South32 for assets which exclusively relate to a BHP Billiton Business or which are used by, or relate to, both the BHP Billiton Businesses and the South32 Businesses and for minerals tenements which are held for the primary purpose or benefit of the BHP Billiton Business. The Separation Deed also contains arrangements in relation to the separation of assets, which are shared by the BHP Billiton Businesses and the South32 Businesses as at the Distribution Date.
- **Contracts:** BHP Billiton must use its reasonable endeavours to transfer each contract to which a BHP Billiton Group member is a party as at the Distribution Date which is exclusively used by, or exclusively relates to, the South32 Businesses to the South32 Group. South32 indemnifies the BHP Billiton Group for all claims and liabilities incurred by the BHP Billiton Group in relation to such contracts, subject to limited exceptions. Reciprocal obligations and indemnities apply to South32 for contracts which are exclusively used by, or exclusively relate to, the BHP Billiton Businesses to which the South32 Group is a party. The Separation Deed also contains arrangements in relation to the separation of contracts which are shared by the BHP Billiton Businesses and the South32 Businesses and identified after the date of the Separation Deed.
- **Exploration data:** South32 will be provided with a copy of certain exploration data held centrally by the BHP Billiton Group relating (i) exclusively to bauxite, manganese or nickel exploration anywhere in the world or (ii) to minerals exploration (other than petroleum) in Africa, certain parts of northeast Australia and certain parts of North America. BHP Billiton will be provided with a copy of certain minerals exploration data held by the South32 Businesses. The rights granted to each party to use the data are subject to applicable laws, third party rights and certain other restrictions.
- **Liability in relation to the disclosure documents:** Except in relation to limited categories of information for which the parties have agreed South32 is responsible, BHP Billiton Limited agrees to indemnify the South32 Group and its directors and officers against any liability arising from a failure of the Shareholder Circular or this document to comply with any applicable legal requirement. South32 agrees to indemnify the BHP Billiton Group and its directors and officers against any liability arising from a failure of the information for which South32 is responsible to comply with any applicable legal requirement.
- **Financial support:** South32 is obliged to use its reasonable endeavours to procure the release of all encumbrances, guarantees and other forms of security and financial support (**Guarantees**) given by, or at the request of the BHP Billiton Group in respect of the South32 Businesses. South32 indemnifies the BHP Billiton Group against all liabilities in relation to such Guarantees until they are released and must pay BHP Billiton a quarterly fee based on the aggregate amount which remains outstanding under such Guarantees after the Distribution Date.
- **Demerger costs:** The Separation Deed sets out the arrangements agreed between BHP Billiton and South32 with respect to the allocation of certain costs associated with the establishment of the South32 Group as an independent and separate company group. Each party indemnifies the other with respect to the costs it has agreed to pay.

- **Employees:** BHP Billiton Limited indemnifies the South32 Group against all claims and liabilities incurred by the South32 Group in relation to current and former employees and contractors, including claims in respect of any entitlements (which ought to have been paid but were not paid), breach of employment terms or the transfer or termination of that employee to the extent those claims and liabilities relate to the relevant employees' or contractors' period of service within a BHP Billiton Business or former BHP Billiton Business. South32 reciprocally indemnifies the BHP Billiton Group in relation to current and former employees and contractors, to the extent those claims and liabilities relate to the relevant employees' or contractors' period of service within a South32 Business or former South32 Business. South32's indemnity is subject to an exception for claims and liabilities which relate to an employee's or contractor's period of service within a South32 Business or former South32 Business where the role of that employee or contractor was part of a BHP Billiton Group-wide function or was established as a result of, or in anticipation of, the Demerger, which are instead the subject of an indemnity from BHP Billiton to the South32 Group. Reciprocal indemnities are also provided in relation to claims and liabilities arising from breaches of workplace laws, including occupational health and safety, equal opportunity and discrimination laws, to the extent relating to service within the BHP Billiton Businesses or former BHP Billiton Businesses and the South32 Businesses or former South32 Businesses, respectively.

For each employee of the BHP Billiton Group on the Distribution Date, BHP Billiton must recognise the period of service of that employee with the BHP Billiton Group prior to the Demerger and is liable for all future service-related entitlements of such an employee (including leave and redundancy). South32 is reciprocally responsible for each employee of the South32 Group on the Distribution Date.

A separate Workers' Compensation Deed, entered into on or around the date of this document by BHP Billiton Limited and South32, relates to the assumption and management of workers' compensation claims and liabilities.

- **Insurance:** All insurance cover provided in relation to the South32 Group or the South32 Businesses under either third party insurance policies which apply to both BHP Billiton and South32 or BHP Billiton captive insurance policies, will cease with effect from the date of the Demerger. However, South32 will retain whatever rights it may hold under those policies in respect of outstanding claims notified before the Demerger and, in respect of occurrence-based liability insurance for which South32 does not obtain replacement retroactive cover, claims which relate to events occurring prior to the Demerger. BHP Billiton will retain the proceeds of any insurance claims relating to the South32 Businesses to the extent those proceeds relate to losses and costs incurred prior to the date of the Demerger.
- **Branding:** The South32 Group must cease to use the BHP Billiton and BHP Billiton Group names and the associated trade marks of the BHP Billiton Group as soon as practicable following the Distribution Date, subject to customary run-off periods, and facilitate orderly separation for signage, stationery, promotional and packaging materials, employee uniforms and the like. The BHP Billiton Group must not use or register any trade marks or any business, company or domain names which are substantially similar to South32 trade marks or which contain references to 'South32' or 'South32 Group' (except in certain limited circumstances).
- **Litigation:** The Separation Deed sets out arrangements pursuant to which the management responsibility for future third party claims will generally rest with the party who ultimately bears liability for that claim based on the terms of the Separation Deed and other transaction documents. This is subject to exceptions for third party claims which relate to:
 - both BHP Billiton and South32, their groups, businesses or former businesses; or
 - regulatory or governmental investigations or prosecutions which may cause reputational harm to the BHP Billiton Group or result in a criminal or civil penalty finding being made or result in a civil claim being brought against the BHP Billiton Group or certain other persons acting for or on its behalf,

in respect of which BHP Billiton will have the right to manage the claim.

Both parties agree to assist each other in respect of the conduct of certain third party claims and agree not to take action in respect of such a claim which could cause liability or reputational damage to the other (or its group) without the other's consent.

- **Ownership of, and access to, records and data:** Other than business records which are exclusively used by, or exclusively relate to, the South32 Businesses (which will be owned by South32), all business records will be owned by BHP Billiton. BHP Billiton will provide to South32 a copy of certain centrally held data relating to the South32 Businesses as part of the separation arrangements for the Demerger. Subject to certain restrictions, each party will be obliged to make available relevant business records and data which relate to the other party's business following the Demerger.

- **Taxation:** The general principle set out in the Separation Deed is that:
 - the BHP Billiton Group will be responsible for all taxes payable, and will receive all tax benefits, which relate to the BHP Billiton Group's Australian tax consolidated groups and the BHP Billiton Businesses and former BHP Billiton Businesses in respect of periods both prior to and after the Distribution Date; and
 - the South32 Group will be responsible for all taxes (other than taxes which relate to the BHP Billiton Group's Australian tax consolidated groups) payable, and will receive all tax benefits, which relate to the South32 Businesses and former South32 Businesses in respect of periods both prior to and after the Distribution Date.

However, the economic benefit, risks and liabilities in respect of certain tax matters have been allocated between BHP Billiton and South32 differently to the result that would follow the application of that principle based on a range of factors (including which party is considered to have the most interest in, and is better placed to manage, the matter). BHP Billiton Limited will also indemnify the South32 Group for tax and stamp duty liabilities incurred by the South32 Group in relation to the internal restructuring steps required to implement the Demerger.

Each party will have the right to manage any tax enquiries, demands or disputes relating to a matter for which it is responsible.

(c) Cash Adjustment Agreement

BHP Billiton Limited and South32 entered into a Cash Adjustment Agreement on or around the date of this document under which they agreed to procure that, on the Economic Separation Date, South32 will hold a specified post-Demerger targeted net cash balance (as set out in Section 14.4(b)). The parties have agreed to make certain payments, and to take certain steps, as may be necessary to achieve that position. On the Economic Separation Date, BHP Billiton Limited will subscribe for a South32 Share for cash consideration, and separately South32 may return capital to BHP Billiton Limited, in each case in such amounts as are required for South32 to arrive at its post-Demerger targeted net cash balance.

(d) Transitional Services Agreement

A wholly-owned subsidiary of BHP Billiton Limited and South32 entered into the Transitional Services Agreement on or around the date of this document under which the parties have agreed to continue to provide some support services to each other on a transitional basis for up to 12 months following the Distribution Date (or up to three years following the Distribution Date for certain services related to the administration of employee incentive plans) to facilitate the South32 Group's separation from BHP Billiton.

The primary services which will be provided by BHP Billiton relate to its facilitating the separation of the South32 Group from the BHP Billiton information technology systems. In this regard, BHP Billiton will provide the South32 Group with temporary access to a cloned version of the BHP Billiton core information technology systems, as well as with support in migrating the South32 Group's data from the clone to its own information technology systems.

BHP Billiton will also provide the South32 Group with support in a number of other areas, including payroll, human resources and reporting, to facilitate the South32 Group's separation.

The transitional support services that South32 will provide for BHP Billiton under the Transitional Services Agreement relate primarily to BHP Billiton's reporting functions.

This page has been intentionally left blank.

15 ADDITIONAL INFORMATION

15.1 INCORPORATION AND ACTIVITIES OF SOUTH32

South32 was incorporated and registered in Australia under the Corporations (New South Wales) Act 1990 (Cth) (the predecessor to the Corporations Act) as a proprietary company on 12 July 2000 with the name 'Brogib Pty Limited' and the ACN 093 732 597 and on 24 August 2000 changed its name to 'BHP Coal Holdings Pty Limited'. On 3 March 2015, South32 was converted into a public company and on 5 March 2015 changed its name to South32 Limited. The principal legislation under which South32 operates, and pursuant to which the South32 Shares have been or will be issued, is the Corporations Act and regulations made thereunder. As at the ASX Listing Date, South32 will hold the Worsley Alumina, South Africa Aluminium, Mozal Aluminium, Brazil Aluminium, South Africa Energy Coal, Illawarra Metallurgical Coal, Australia Manganese, South Africa Manganese, Cerro Matoso and Cannington South32 Businesses (subject, where applicable, to the Demerger Resolution being passed by BHP Billiton Shareholders, the BHP Billiton Board declaring the Demerger Dividend and the other conditions precedent to the Demerger being satisfied or waived).

South32 is domiciled in Australia and its current address is Level 20, Waterfront Place, 1 Eagle Street, Brisbane, Qld, 4000. South32's current principal place of business is Level 32, Brookfield Place, 125 St Georges Terrace, Perth, WA, 6000. It is proposed that following implementation of the Demerger, South32's principal business address will be Level 35, 108 St Georges Terrace, Perth, WA, 6000. The telephone number of South32's office is +61 8 9324 9000.

KPMG, an Australian partnership and a member firm of the KPMG network of independent member firms affiliated with KPMG International Cooperative (**KPMG International**), a Swiss entity, whose address is 10 Shelly Street, Sydney NSW 2000 has been the auditor of South32 since 20 May 2003.

15.2 CORPORATE HISTORY

Prior to the Internal Restructure and other steps described in Section 14, South32 was the holding company for the Illawarra Metallurgical Coal business. South32 has owned that business since 2000 and except as disclosed in this document, in the five years prior to the Internal Restructure, there were no material changes in the nature of the business carried on by South32 and its subsidiaries (being mining). South32 has acquired, or will acquire, the other South32 Businesses pursuant to the restructure described in Section 14.2. Information regarding each of the South32 Businesses is set out in Section 7.

15.3 SHARE CAPITAL OF SOUTH32

The rights attaching to South32 Shares are set out in South32's Constitution, a summary of which is set out in Section 15.4.

(a) Total issued share capital

On incorporation, two South32 Shares of no par value in the capital of South32 were issued and were fully paid up in cash. South32 had 450,000,004 shares on issue as at 14 March 2015, being the latest practicable date prior to the publication of this document.

At General Meetings of BHP Billiton Limited Shareholders and BHP Billiton Plc Shareholders to be held on 6 May 2015, the BHP Billiton Limited Shareholders and BHP Billiton Plc Shareholders will be asked to vote on the Demerger Resolution.

As at 14 March 2015 (being the latest practicable date prior to the publication of this document) and except as disclosed in this document, there has been no issue of share or loan capital by South32 since its incorporation and no share or loan capital of South32 is under option or agreed, conditionally or unconditionally, to be put under option.

As at 14 March 2015 (being the latest practicable date prior to the publication of this document), South32 does not hold any South32 Shares in treasury. South32 has no convertible securities, exchangeable securities, redeemable preference shares or securities with warrants on issue.

As part of implementing the Demerger, South32 intends to carry out a share division and issue as described in Section 9.3(a), such that the actual number of South32 Shares at the time of implementation of the Demerger will be equal to the number of BHP Billiton Shares on issue on the relevant Record Date. Other than as aforesaid, there has not been any other splitting or sub-division of the shares or other securities of South32, nor has there been any consolidation of shares or securities during the past three years.

As at 14 March 2015 (being the latest practicable date prior to the publication of this document), there were 3,211,691,105 BHP Billiton Limited ordinary shares and 2,112,071,796 BHP Billiton Plc ordinary shares on issue.

Other than the South32 Shares which are to be admitted to trading on the ASX, JSE and LSE, no other securities have been issued by South32. When admitted to trading on the ASX, JSE and LSE, the ISIN of the South32 Shares will be AU000000S320.

South32 will also establish an ADS program, but the South32 ADSs will not be admitted to trading on the New York Stock Exchange or any other securities exchange in the United States and will trade over-the-counter.

(b) Confirmations

As at 14 March 2015 (being the latest practicable date prior to the publication of this document), except as disclosed in this document:

- no share or loan capital of South32 has, since the incorporation of South32, been issued or agreed to be issued, or is now proposed to be issued, fully or partly paid, either for cash or for a consideration other than cash, to any person;
- no commission, discounts, brokerages or other special terms have been granted by South32 in connection with the issue or sale of any share or loan capital;
- no share or loan capital of South32 is under option or agreed, conditionally or unconditionally, to be put under option;
- no debentures or debenture stock have been issued by South32;
- no loan capital is outstanding, except as disclosed in Section 9.3;
- no contract or arrangement is in place or is proposed to be put in place for options or preferential right to be granted to any person to subscribe for securities of South32 or any of its subsidiaries.

No South32 Share has been marketed to, nor are any South32 Shares available for purchase by, the public in the United Kingdom or elsewhere in connection with the introduction of the South32 Shares to the Official List.

As at the date of this document, South32 and its subsidiaries have not made any material loans nor are there any such material loans previously made which remain outstanding, other than as set out in Section 9.3. There have been no instances where the directors of South32 have exceeded their borrowing powers.

(c) Major South32 Shareholders

As at the date of this document, the entire issued share capital of South32 is held by BHP Billiton Limited. Immediately following the Demerger, the shareholders of South32 shall be the same as the shareholders of BHP Billiton as at the relevant Record Date, except where BHP Billiton Shareholders are Ineligible Overseas Shareholders or elect to sell their South32 Shares pursuant to the Sale Facility.

To the knowledge of South32 and BHP Billiton Limited:

- BHP Billiton is not directly or indirectly owned or controlled by another corporation or by any foreign government;
- immediately following the implementation of the Demerger, there is no person who, directly or indirectly, jointly or severally, will exercise or could exercise control over South32;
- there are no arrangements the operation of which may at a subsequent date result in a change in control of BHP Billiton or (other than as a result of implementation of the Demerger) South32;
- no public takeover offers by third parties have been made in respect of BHP Billiton Shares or by BHP Billiton in respect of other companies' shares during the current or preceding financial year.

As at 14 March 2015 (being the latest practicable date prior to the publication of this document), to the knowledge of South32 and BHP Billiton Limited, there are no persons that are directly or indirectly interested in five per cent or more of the issued shares in BHP Billiton Limited and the following persons are directly or indirectly interested in three per cent or more of the issued shares in BHP Billiton Plc:

- Aberdeen Asset Managers Limited, which holds 157,061,561 shares of which it controls voting rights in respect of 127,971,161 shares, representing 6.06 per cent of the BHP Billiton Plc Shares on issue (as notified on 13 March 2015);
- BlackRock Inc, which holds and controls voting rights in respect of 213,014,043 shares, representing 10.08 per cent of the BHP Billiton Plc Shares on issue (as notified on 3 December 2009),

and none of the shareholders referred to above has or will have different voting rights from any other holder of South32 Shares in respect of any South32 Shares held by them.

(d) South32 Shares issued during the three years prior to the date of this document

In the three years prior to the date of this document, there have been no shares issued by South32, except to BHP Billiton Limited or BHP Billiton Plc or one of its subsidiaries.

(e) Form and currency of the South32 Shares

The South32 Shares will be in registered form and will be capable of being held in certificated form in South Africa (with a register of dematerialised beneficial interests in South32 Shares maintained by the Strate Nominee) and uncertificated form in Australia. South32 Shares held in CREST in the UK will be represented by uncertificated South32 Depositary Interests.

South32's registries are:

- Principal share registry – Australia
Computershare Investor Services Pty Limited
Yarra Falls, 452 Johnston Street
Abbotsford VIC 3067

- Branch share registry – South Africa
Computershare Investor Services (Pty) Ltd
70 Marshall Street
Johannesburg 2001
- Depository Interests registry – United Kingdom
Computershare Investor Services PLC
The Pavilions, Bridgwater Road
Bristol BS99 6ZZ

The South32 Shares will be denominated in Australian dollars and quoted in Australian dollars on the ASX, South African rand on the JSE and pounds sterling on the LSE.

South32 ADSs will be denominated in US dollars.

(f) Rights attached to the South32 Shares

All South32 Shares will rank pari passu in all respects, there being no preferential conversion or exchange rights attaching thereto, and all of the South32 Shares will have equal rights to participate in capital, dividend and profit distributions by South32 and to vote at general meetings in accordance with the Constitution (as summarised in Section 15.4(g)). The provisions of the Constitution governing the variation of class rights are summarised in Section 15.4(l).

(g) Free transferability of the South32 Shares

There are no restrictions on the transferability of the South32 Shares imposed by the South32 Constitution.

(h) Authorities relating to the South32 Shares

The issue of South32 Shares to BHP Billiton Limited and BHP Billiton Plc in connection with the Demerger (see Section 9.3) will occur in accordance with agreements, the entry into which has been approved by the boards of each company.

At General Meetings of BHP Billiton Limited Shareholders and BHP Billiton Plc Shareholders to be held on 6 May 2015, the BHP Billiton Limited Shareholders and BHP Billiton Plc Shareholders will vote on the Demerger Resolution.

The distribution of the South32 Shares to BHP Billiton Shareholders pursuant to the Demerger Dividend will be undertaken in accordance with the BHP Billiton Limited constitution and the BHP Billiton Plc articles of association.

15.4 SUMMARY OF SOUTH32'S CONSTITUTION

(a) South32's Constitution and rights attaching to South32 Shares

On its conversion to a public company, South32 adopted the South32 Constitution, which is designed for a public listed company. The South32 Constitution is designed for an ASX-listed company and has regard to usual market practice for ASX-listed companies.

Some important features of the South32 Constitution are summarised in paragraphs 15.4(b) to 15.4(p) below:

(b) Powers of the South32 Board

The South32 Board is to manage or direct the business and affairs of South32, and may exercise all powers and do all things within the power of South32 that are not required to be done in a general meeting. In doing so, the South32 Board may exercise all of the powers of South32 to borrow or raise money, to charge any property or business of South32 or all or any of its uncalled capital and to issue debentures or give any other security for a debt, liability or obligation of South32 or any other person.

(c) Rights and duties of South32 Directors

The South32 Constitution deals with the rights and obligations of South32 Directors and officers of South32, including:

- the appointment, retirement and removal of directors, including the managing director and chairperson;
- the appointment of a company secretary;
- the remuneration of directors;
- the powers of directors;
- meetings and written resolutions of directors;
- the rights of directors and officers to be indemnified (subject to law) against all liabilities incurred as an officer of South32.

(d) Composition of South32 Board

The South32 Board will comprise of at least three and no more than 11 directors. Details of the known members of the proposed South32 Board as at the ASX Listing Date are set out in Section 8.1.

A person is able to be elected as a director at a general meeting of South32 if they have been nominated by the South32 Board or they are already a director of South32. An external candidate is eligible for election as a director if they have been nominated by at least the same number of members required to requisition a resolution at a general meeting of South32, and they have given notice to South32 in accordance with the South32 Constitution.

The quorum for a meeting of directors is two directors of South32. Resolutions at a meeting of directors are to be decided by a majority vote. In the case of an equality of votes, the Chairman of a meeting has a casting vote, unless only two directors of South32 are present.

There is no mandatory age of retirement for directors of South32 and the South32 Constitution provides that directors are not required to hold shares in South32. While directors of South32 are not required by the South32 Constitution to hold shares in South32, the South32 Board proposes to implement a policy in relation to Non-executive Director share ownership, as described in Section 8.1(b).

(e) Conflicts of interest

Under the South32 Constitution, the directors of South32 may make regulations requiring the disclosure of interests that a director may have. A director who has an interest in a matter that is being considered at a meeting of the South32 Board may, despite that interest, be present and be counted in a quorum at the meeting and vote, unless that is prohibited by the Corporations Act. The Corporations Act requires a director who has a material personal interest in a matter to give the other directors notice of the interest, and is not permitted to be present and vote on the matter (unless the other directors resolve otherwise).

(f) General meetings

General meetings of South32 are to be held in accordance with the Corporations Act, and each South32 Shareholder will be entitled to receive notice of a general meeting in accordance with the Corporations Act and, except in certain circumstances, attend and vote at general meetings of South32.

(g) Voting at a general meeting

Subject to the South32 Constitution, the Corporations Act and any special rights or restrictions for the time being attached to any class of South32 Shares, at a general meeting each South32 Shareholder present in person, or by attorney, corporate representative or proxy, has one vote on a show of hands, and one vote for each fully paid South32 Share on a poll.

Voting at any meeting of South32 Shareholders is by a show of hands (unless a poll is demanded). Direct votes are counted only on a poll. The quorum required for a meeting of South32 Shareholders is five members present and entitled to vote on a resolution at the meeting (whether in person, or by attorney, corporate representative or proxy). Direct votes are not counted as part of the quorum.

(h) Dividends

Under the South32 Constitution, the South32 Directors may determine that a dividend is payable on a class of shares, fix the amount and the date for payment, and determine the method of payment of the dividend to each South32 Shareholder entitled to that dividend. If a dividend is paid, it will be paid equally on all South32 Shares, except in the case of partly paid South32 Shares where the dividend will be in proportion to the percentage of the issue price that has been paid (excluding amounts credited and amounts paid in advance of a call).

The South32 Directors may:

- pay dividends wholly or partly by the distribution of specific assets, including securities of South32 or of another body corporate (to the extent making such a distribution to some South32 Shareholders is contrary to law or considered impracticable, South32 may make a cash payment to those South32 Shareholders or allocate the assets or securities to a trustee to be sold on behalf of those South32 Shareholders);
- require South32 Shareholders to receive dividends by electronic transfer to a nominated bank account and credit dividends to a company account where a shareholder has not provided bank account details. If a South32 Shareholder has not claimed a dividend payment for more than 11 calendar months after payment to a company account, the South32 Directors may reinvest that amount, after deducting reasonable expenses, into shares in South32 on behalf of, and in the name of, the South32 Shareholder.

Interest is not payable in respect of any dividend.

(i) Issue of further South32 Shares

Subject to the Corporations Act and the ASX Listing Rules:

- the issue of shares (including partly paid shares and redeemable preference shares) in South32 is under the control of the South32 Board;
- the South32 Board has the power to issue shares, options and other securities convertible into shares to any person at any time and on such terms as it determines.

(j) Proportional takeover provisions

The Constitution requires South32 Shareholder approval in relation to any proportional takeover bid. These provisions will cease to apply unless they are renewed by South32 Shareholders passing a special resolution by the third anniversary of either the date that those rules were adopted or the date those rules were last renewed.

(k) Small holdings

While South32 is listed, it may (unless the South32 Shareholder notifies South32 otherwise during the relevant notification period) sell the South32 Shares of a South32 Shareholder who holds less than a marketable parcel of South32 Shares.

(l) Variation of class rights

The rights attached to any class of share may be altered with the sanction of a special resolution passed at a separate meeting of the holders of shares of the affected class, or with the written consent of the holders of at least 75 per cent of the shares of the affected class.

(m) Calls, forfeiture and liens

South32 has a first lien on every South32 Share for, among other things, all due and unpaid calls, and all money which South32 is required by law to pay, and has paid, in respect of a South32 Share.

If a South32 Shareholder fails to pay a call in respect of any amount unpaid on any South32 Shares on the payment date specified, South32 may give notice to that South32 Shareholder requiring payment of that call, together with any costs and interest that has accrued. If, after receiving notice, the call remains unpaid, the directors of South32 may by resolution forfeit the relevant South32 Shares.

The directors of South32 may sell, otherwise dispose of or re-issue South32 Shares forfeited in this way, subject to compliance with the Corporations Act and the ASX Listing Rules.

(n) Indemnification

South32 may, to the maximum extent permitted by law, indemnify any current or former director, secretary or officer of South32 or of its related bodies corporate against all losses, liabilities, costs and expenses incurred by the person in that capacity.

(o) Winding up

If South32 is wound up, the liquidator may, with the sanction of a special resolution of South32 Shareholders, distribute among South32 Shareholders the whole or any part of the property of South32 and may determine how to distribute the property as between South32 Shareholders or different classes of South32 Shareholders.

(p) Arrangements in respect of shares received as distributions from BHP Billiton Plc

Each South32 Share which is transferred to BHP Billiton Plc Certificated Shareholders who are Eligible BHP Billiton Plc Shareholders and Eligible BHP Billiton Plc Shareholders who hold their shares in CREST will automatically be transferred to Computershare Australia against the issue of a DI representing that South32 Share (see Section 15.6(d) for further details). DIs will be issued directly to BHP Billiton Plc Shareholders who hold their shares in CREST. DIs issued in respect of shares transferred to BHP Billiton Plc Certificated Shareholders who are Eligible BHP Billiton Plc Shareholders will be issued to a subsidiary of Computershare Investor Services PLC which will hold them as nominee for the entitled shareholder under the CSN Facility unless, in each case, they elect otherwise (see Section 15.6(e) for further details).

(q) Dividend reinvestment plan

South32 may establish a dividend reinvestment plan on any terms as the South32 Board resolves under which South32 Shareholders may elect to apply the whole or part of a dividend from South32 to subscribing for or purchasing South32 Shares.

(r) South32 subsidiary constitutional director remuneration provisions

Each of the subsidiaries of South32 is subject to the requirements set out by its constitution or, if the subsidiary has not adopted a constitution, the rules that apply by default under applicable law. The constitutions of South32 subsidiaries generally provide that the remuneration payable to directors is to be fixed by South32 in a general meeting, either on an individual basis or as a total amount from within which the subsidiary board may determine individual directors' remuneration. In some jurisdictions, directors' remuneration is determined by the subsidiary board, which is subject to applicable directors' duties under law. Directors may also, in some circumstances, be entitled to receive additional remuneration for undertaking special exertions.

15.5 LISTING

Application will be made to the ASX for quotation of the South32 Shares. It is expected that the ASX admission will become effective and that dealings (on a deferred settlement basis) on the ASX of the South32 Shares will commence at 12:00pm (AEST) on 18 May 2015.

Application has been made to the JSE for the South32 Shares to be admitted to listing and trading on the main board of the JSE. It is expected that the JSE admission will become effective and that dealings on the JSE will commence at 9:00am (SAST) on 18 May 2015.

Application will be made to the UKLA for all of the issued South32 Shares to be admitted to the standard listing segment of the Official List and to the LSE for the South32 Shares to be admitted to trading on its main market for listed securities. It is expected that when-issued dealing in the South32 Shares will commence at 8:00am (BST) on 18 May 2015 and that the South32 Shares will be admitted to listing and trading at 8:00am (BST) on 26 May 2015.

Upon admission of South32 Shares to trading on the ASX, JSE and LSE, South32 will be subject to the ASX Listing Rules, the JSE Listing Rules applicable to secondary listed issuers and the standard listing requirements pursuant to Chapter 14 of the UKLA Listing Rules.

South32 will also establish an ADS program, but the South32 ADSs will not be listed on the New York Stock Exchange or any other securities exchange in the United States and will trade over-the-counter, with regular way trading of ADSs to commence on 1 June 2015.

15.6 SOUTH32 SHAREHOLDINGS

(a) South32 Shareholdings

Unless Eligible Shareholders elect otherwise (where they are entitled to do so), the way in which they will receive their South32 Shares will depend on how they hold their BHP Billiton Limited or BHP Billiton Plc Shares, as described below in Tables 15.1 and 15.2:

Table 15.1: BHP Billiton Limited Shareholders

Manner in which BHP Billiton Limited Shares are held	Manner in which South32 Shares will be held	Default form of confirmation
On BHP Billiton Limited's CHESS subregister	On South32's CHESS subregister	CHESS confirmation advice will be despatched on 1 June 2015 CHESS statement will be despatched at the end of June 2015
On BHP Billiton Limited's issuer sponsored subregister	On South32's Australian issuer sponsored subregister	Issuer sponsored holding statement will be despatched on 1 June 2015

Table 15.2: BHP Billiton Plc Shareholders

Manner in which BHP Billiton Plc Shares are held	Manner in which South32 Shares will be held	Default form of confirmation
On the United Kingdom register in CREST	In DI form credited to the same CREST account on the South32 register as the shareholder's BHP Billiton Plc Shares are held (see Section 15.6(d))	A credit to the CREST account of the applicable South32 Dis
On the United Kingdom register in certificated form (for BHP Billiton Shareholders who do not have a registered address in a CSN Restricted Jurisdiction) (see Section 15.6(e))	In a CSN account maintained by Computershare Investor Services PLC (see Section 15.6(e))	CSN holding statements will be despatched on 1 June 2015 by first class mail
On the United Kingdom register in certificated form (for BHP Billiton Shareholders with a registered address in a CSN Restricted Jurisdiction) (see Section 15.6(e))	On South32's Australian issuer sponsored subregister	Issuer sponsored holding statement will be despatched on 1 June 2015
On the register of dematerialised beneficial interests maintained by Strate in an account with a CSDP or broker	In dematerialised form in the same CSDP or broker account as the shareholder's BHP Billiton Plc Shares are held	South32 Shareholder's CSDP or broker accounts will be credited on 25 May 2015
On the South African branch register in certificated form	On the South32 South African branch register	South32 Share certificates will be despatched, at the South32 Shareholder's risk, on or about 25 May 2015 by registered post

(b) Small holdings (post Demerger)

In order to reduce the costs and administration associated with servicing large numbers of shareholders with small holdings, South32 may, after implementation of the Demerger, consider implementing an arrangement under which the South32 Shares held by a South32 Shareholder with less than a marketable parcel as set by the ASX Listing Rules (currently being a parcel of securities with a market value of less than A\$500) could be aggregated and sold on their behalf, unless these shareholders elect to retain their South32 Shares. This is not part of the Demerger and, if South32 decides to implement this arrangement, full details will be released at the time.

(c) Registration of South32 shareholdings on another register

If BHP Billiton Shareholders (other than South African Shareholders) wish to opt-out of the arrangements set out in Section 15.6(a) and elect to have their South32 Shares registered on another register, they should contact Computershare by calling the Shareholder Information Line. Computershare will explain the register election process that must be followed by BHP Billiton Shareholders (other than South African Shareholders) who wish to have their South32 Shares held on another register (**Register Election**). The Register Election process must be completed on or prior to the applicable Record Date for the register on which the BHP Billiton Shareholder holds their BHP Billiton Shares. The South32 register election process will not result in the BHP Billiton Shares held by that Shareholder being transferred to the elected register.

The Register Election option is not available to South African Shareholders because South African Exchange Control Regulations do not permit South African Shareholders to hold their shares on a register outside South Africa without obtaining the prior approval of the FinSurv Department (see Section 15.10(d)).

After the distribution of South32 Shares, South32 Shareholders on all registers (including South African Shareholders) will be able to request to have their South32 Shares moved to another register by contacting Computershare's Global Transaction team in the respective region. Movements between registers are usually completed within 24 hours, depending on the time of lodgement and allowing for time differences in the respective jurisdictions and, in the case of South African Shareholders, are subject to the requirement that the prior approval of the FinSurv Department must first be obtained.

(d) Explanation of South32 DI arrangements

(1) What is a South32 DI?

A depositary interest (**Depositary Interest** or **DI**) enables the holder to hold and settle transfers of South32 Shares in CREST. CREST is a paperless settlement system which allows securities to be transferred from one person's CREST account to another electronically. Securities of issuers domiciled outside the United Kingdom and Ireland, such as South32, cannot be held or settled directly in CREST. South32 has therefore entered into arrangements to enable investors to hold, and settle transfers of, South32 Shares in CREST in the form of South32 DIs. Each South32 DI represents an entitlement to one underlying South32 Share. Underlying South32 Shares will be listed on the UKLA Official List and traded on the LSE. South32 DIs will be transferred in CREST to settle those trades in exactly the same way as an ordinary share.

The UK Depositary was appointed under the DI Depositary Agreement to issue the South32 DIs on the terms of the Deed Poll and to provide certain other services in connection with the South32 DIs, in exchange for certain fees and expenses.

These services include acting as custodian, complying with the provisions of the Deed Poll, maintaining a depositary interest register, processing distributions and dealing with routine correspondence with holders of South32 DIs.

South32 has agreed to indemnify the UK Depositary for all losses resulting from, or in connection with, the depositary, custodian and dividend services. The UK Depositary's liability to South32 is subject to exclusions and limitations.

(2) How will the South32 DIs work?

South32 Shares distributed to registered holders of BHP Billiton Plc Shares (other than the Strate Nominee and BHP Billiton Plc Shareholders on the South African branch register) who are Eligible Shareholders will initially be registered in their names on South32's Australian issuer sponsored subregister. Under Rule 15.3 of the South32 Constitution, these shares will then be automatically transferred to Computershare Australia, which will hold those shares on behalf of the UK Depositary in its nominee account within the Australian settlement system, CHESS. The UK Depositary will credit South32 DIs to participants' CREST accounts against the receipt of underlying South32 Shares by Computershare Australia. A South32 DI register of CREST participants will be held in the United Kingdom showing full details of the registered South32 DI holders in a similar fashion to the register of legal ownership of South32 Shares. The South32 DI register will be wholly uncertificated and South32 DIs can only be held and transferred between CREST participants.

The South32 DIs will be created and issued under the Deed Poll, which will govern the relationship between the UK Depositary and the holders of the South32 DIs.

Summary of the principal terms of the Deed Poll

Under the Deed Poll, Computershare Australia (on behalf of the UK Depositary) will hold the underlying South32 Shares on trust for all holders of South32 DIs as tenants in common and will hold on trust and pass on to holders of South32 DIs any stock or cash benefits received by it as holder of the underlying South32 Shares.

Holders of South32 DIs will be able to exercise the rights attached to the South32 Shares represented thereby and will be treated in the same way as registered South32 Shareholders in respect of all other rights attaching to South32 Shares, in each case, so far as possible in accordance with applicable CREST Regulations, CREST requirements and applicable law. Holders of South32 DIs will not, however, be able to vote on a show of hands and must give prompt instructions to the UK Depositary or its nominated custodian, in accordance with any voting arrangements made available to them, to vote the underlying South32 Shares on their behalf or to take advantage of any arrangements enabling holders of South32 DIs to vote such shares as a proxy of the UK Depositary or its custodian.

Following the issue of the South32 DIs, holders will be able to cancel their South32 DIs in CREST in order to hold their underlying South32 Shares directly on the Australian or South African register (upon sending an instruction to CREST to that effect).

Holders of South32 DIs will be required to warrant, among other things, that South32 Shares issued or transferred to the UK Depositary (or a custodian on its behalf) after the Demerger will be free and clear of all third party security interests and that such transfers are not in contravention of any contractual obligation, law or regulation.

Subject to certain exceptions, the UK Depositary, Computershare Australia and any custodian or agent appointed by them (and their respective officers, employees and agents) are entitled to be indemnified against all liabilities incurred in the performance of their obligations under the Deed Poll and may make deductions from income or capital receipts which would otherwise be due to the South32 DI holder and/or sell the underlying South32 Shares and make such deductions from the proceeds of sale as may be required for this purpose or to meet any tax liability of such South32 DI holder in respect of which the UK Depositary is required to make any deduction or withholding. Save for liabilities which arise from the acts or instructions of a South32 DI holder and any tax liability of a South32 DI holder, each South32 DI holder's liability is limited to the cash and other property which the UK Depositary holds on trust for that South32 DI holder from time to time (**Trust Property**).

The Deed Poll permits the UK Depositary to charge South32 DI holders fees and expenses out of Trust Property and contains provisions excluding and limiting the UK Depositary's liability. The UK Depositary will not be liable for any acts or omissions of South32, the CREST operator or any third party reasonably appointed by the UK Depositary outside its group to provide services in connection with the South32 DIs.

The liability of the UK Depositary is limited to the lesser of the value of (a) the deposited property attributable to the holder of South32 DIs and (b) the proportion of £5,000,000 which corresponds to the portion of the UK Depositary's liability to the South32 DI holder relative to the UK Depositary's liability to all holders in respect of the same act, omission or event. The UK Depositary may terminate the Deed Poll by giving at least 30 days' notice to South32 DI holders.

The Trust Property will be held in pooled accounts. In the event of any shortfall in those accounts, South32 DI holders will be entitled to their pro rata share of the available South32 Shares or cash.

The UK Depositary may amend the Deed Poll by giving 30 days' notice to South32 DI holders.

The UK Depositary or Computershare Australia (or any other duly appointed nominee or custodian) may require any holder of South32 DIs to provide information in relation to their holdings of South32 DIs on the same basis as such information may be required from a holder of South32 Shares.

The Deed Poll is governed by English law. A copy of the Deed Poll is available on the BHP Billiton website at www.bhpbilliton.com/demerger and will be available on the South32 website in due course.

(e) Explanation of Corporate Sponsored Nominee (CSN) arrangements

(1) What is a CSN and how does the CSN Facility work?

In order to be admitted to trading on the LSE, transfers of South32 Shares must be eligible for settlement in CREST. As shares in Australian companies, such as South32, are not eligible for settlement in CREST, South32 has made the arrangements described in Section 15.6(d)(2) for South32 Shares to be represented by South32 DIs. South32 DIs can be held and settled in CREST.

As BHP Billiton Plc Certificated Shareholders are not holding their BHP Billiton Plc Shares in CREST accounts, in order to enable BHP Billiton Plc Certificated Shareholders to hold the South32 Shares they will receive in a form which can be traded on the LSE, South32 has arranged for the UK Nominee to act as a nominee to hold South32 DIs representing South32 Shares for BHP Billiton Plc Certificated Shareholders (**CSN Facility**). Under the CSN Agreement, the UK Depositary has agreed to provide registrar services including maintaining records of participants in the CSN Facility, issuing statements of ownership, providing online access to enable participants to view their holdings, processing electronic instructions on their behalf, providing proxy services, processing distributions and providing a dealing facility.

The CSN Agreement includes limitations and exclusions of the UK Depositary's liability, mutual indemnities and provision for the payment of fees and expenses to the UK Depositary.

Summary of the principal CSN Terms and Conditions

The UK Nominee will hold South32 DIs for CSN Participants on the CSN Terms and Conditions. Under the CSN Terms and Conditions, CSN Participants are the beneficial owners of the South32 DIs to which they relate and may give instructions to transfer the South32 DIs or underlying South32 Shares. By participating in the CSN Facility, CSN Participants warrant and undertake that they will not grant any liens, charges or encumbrances over their South32 DIs.

The UK Nominee agrees to pass on company communications and act on CSN Participants' instructions to exercise voting and other rights in relation to their underlying South32 Shares (provided that it is put in funds if it is required to make any payment) and to take all reasonable steps to treat CSN Participants, so far as possible, in the same way as a registered holder of South32 Shares.

The UK Nominee is appointed as agent for the CSN Participants to give CREST instructions. The UK Nominee is not responsible for losses incurred from acts or omissions of the CREST member through whom messages are delivered into CREST on its behalf or arising from CREST. CSN Participants are required to indemnify the UK Nominee for costs and liabilities which may arise if they require the UK Nominee to give CREST instructions which cannot be completed for any reasons connected with the CSN Participant.

Client money held on behalf of CSN Participants will be held in pooled accounts. The UK Nominee will be entitled to set off amounts it owes to a CSN Participant against any amounts owed to it by that CSN Participant. The UK Nominee may make deductions in respect of any applicable withholding tax from payments due to a CSN Participant.

The UK Nominee may terminate a CSN Participant's participation in the CSN Facility if the CSN Participant breaches the CSN Terms and Conditions, in which case, the UK Nominee will transfer the underlying South32 DIs or South32 Shares to an account nominated by the CSN Participant.

No charges are payable by a CSN Participant other than for services requested by that CSN Participant.

CSN Participants may be required to provide information in relation to their underlying holdings of South32 DIs on the same basis as such information may be required from a holder of South32 Shares.

The CSN Terms and Conditions do not restrict a participant's rights under the rules of the Financial Conduct Authority or the UK Financial Services Act 2012 and can be amended with South32's consent.

The CSN Terms and Conditions are governed by English law.

The CSN Terms and Conditions are available on the BHP Billiton website at www.bhpbilliton.com/demerger and will be available on the South32 website in due course.

(2) Termination and your right to cancel your participation in the CSN Facility

A CSN Participant may cancel their participation in the CSN Facility by giving the UK Nominee written notice within 30 days after normal trading in South32 Shares commences on the LSE (which is expected to be on 26 May 2015). If a CSN Participant cancels their participation in the CSN Facility, the UK Nominee will transfer the underlying South32 DIs or South32 Shares to such person as the CSN Participant may nominate and no fees will be charged for such transfer.

Thereafter, a CSN Participant may terminate their participation in the CSN Facility and a transfer fee (currently £17.50) will apply.

(3) Participation in the CSN Facility is limited to South32 Shareholders in certain jurisdictions

The ability to participate in the CSN Facility may be restricted or made onerous by law in certain jurisdictions. Any BHP Billiton Plc Certificated Shareholder who has a registered address in the United States or any other CSN Restricted Jurisdiction will not be entitled to participate in the CSN Facility. Instead, those BHP Billiton Plc Certificated Shareholders will be issued their South32 Shares on the Australian issuer sponsored subregister, with an issuer sponsored holding statement issued reflecting their South32 shareholding.

The UK Nominee will provide a dealing service for CSN Participants. Details of this service are available on the BHP Billiton website at www.bhpbilliton.com/demerger and will be available on the South32 website in due course.

15.7 TRADING YOUR SOUTH32 SHARES

(a) Trading on the ASX

South32 will apply to participate in CHESS, in accordance with the ASX Listing Rules and ASX Settlement Operating Rules. CHESS is an electronic transfer and settlement system for transactions in securities quoted on the ASX under which transfers are effected in electronic form. South32 Shareholders who hold their South32 Shares on the CHESS or Australian issuer sponsored subregister will be able to sell or buy South32 Shares through their existing ASX participant broker. South32 is expected to trade under the ASX code of S32.

(b) Trading on the JSE

Application will be made to the JSE for a secondary listing by way of introduction of all the issued South32 Shares in the general mining sector of the Main Board of the JSE under the abbreviated name South32 and share code S32, with effect from the commencement of trading on the JSE on 18 May 2015.

Strate is the authorised Central Securities Depository (**CSDP**) for the electronic settlement of all financial instruments in South Africa. Shares that are not represented by documents of title and that have been replaced with electronic records of ownership are referred to as dematerialised or uncertificated shares. Shares that are evidenced by share certificates or other documents of title are referred to as certificated shares. The CSDPs are the only market participants who can liaise directly with Strate. Under the Strate system, there are essentially two types of clients: controlled and non-controlled. Controlled broker clients elect to keep their shares and cash in the custody of their broker and, therefore, indirectly the broker's chosen CSDP. Controlled clients deal directly and exclusively with their broker. Non-controlled broker clients appoint their own CSDP. A non-controlled client receives share statements directly from their CSDP.

South32 Shares will be traded and settled on the JSE through Strate only in electronic form as dematerialised or uncertificated South32 Shares. Accordingly, any person who acquires South32 Shares and who elects to receive such South32 Shares in certificated form will be required to dematerialise their interest in such certificated South32 Shares in order to be able to trade such South32 Shares on the JSE. It is noted that there are risks associated with holding shares in certificated form, including the risk of loss or tainted scrip, which are no longer covered by the JSE Guarantee Fund. To facilitate trading on the JSE through Strate, the dematerialised South32 Shares on the Strate Nominee Register will be immobilised and registered in certificated form in the name of the Strate Nominee. This will not, however, affect the operation of the Strate system. The beneficial holders of such South32 Shares will have their beneficial interests in such South32 Shares recorded in accounts maintained by each CSDP, and transfer and settlement of such beneficial title will be effected through Strate and in accordance with the Strate rules. Each beneficial holder will be required to maintain an account with a CSDP or broker and will instruct their CSDP or broker regarding voting and other matters in accordance with the mandate entered into between such beneficial holder and their CSDP or broker. If a beneficial holder wishes to attend a meeting of South32 in person, they will need to request a proxy form from their CSDP or broker, who will then obtain such proxy form from the Strate Nominee via Strate. The dividends due to the beneficial holders will be paid into their accounts by their CSDP or broker. South32 intends to procure the distribution of all notices and other documentation to all beneficial holders who have indicated their desire to receive such notices and other relevant documentation.

(c) Trading on the LSE

As settlement of South32 Shares cannot occur through CREST, settlement of trades in South32 Shares on the LSE will only occur in the form of South32 DIs. South32 DIs will be credited to CREST accounts of Eligible BHP Billiton Plc Shareholders whose BHP Billiton Plc Shares are held in CREST. Trading on the LSE and settlement of such trades through CREST as South32 DIs will take place in exactly the same way as with an ordinary share. The South32 Shares and South32 DIs will have the same ISIN. South32 is expected to trade under the LSE code of S32.

Any BHP Billiton Plc Certificated Shareholder whose registered address is not in a CSN Restricted Jurisdiction will be able to trade their South32 Shares through the CSN dealing service, full details of which are available on the BHP Billiton website at www.bhpbilliton.com/demerger and will be available on the South32 website in due course. It is expected that any trades on behalf of a CSN Participant will be carried out on the LSE and settled by the transfer of South32 DIs.

(d) Trading of South32 ADSs

The South32 ADSs will not be listed on any exchange in the United States. Instead, the South32 ADSs will be eligible for trading on the United States over-the-counter market. Settlement of South32 ADSs traded on the over-the-counter market will take place through the facilities of the Depository Trust Company. If a person wishes to trade the South32 ADSs, they should consult their broker or other securities intermediary to determine how the South32 ADSs may be traded and how such trades may be settled in the United States.

15.8 FOREIGN OWNERSHIP AND OTHER SHAREHOLDING RESTRICTIONS – GENERAL

(a) Corporations Act

The takeover provisions in Chapter 6 of the Corporations Act restrict acquisitions of a relevant interest in shares in listed companies, and unlisted companies with more than 50 members, if the acquirer's (or another party's) voting power would increase to above 20 per cent, or would increase from a starting point that is above 20 per cent and below 90 per cent, unless certain exceptions apply.

The Corporations Act also imposes notification requirements on persons having voting power of five per cent or more in South32.

(b) Restriction on foreign ownership

There are no limitations, either under the laws of Australia or under the South32 Constitution, to the right of non-residents to acquire, hold and vote South32 Shares other than the Foreign Acquisitions and Takeovers Act 1975 (Cth) (**FATA**).

The FATA may affect the rights of certain persons to acquire South32 Shares. Specifically, under the FATA any acquisition by:

- a foreign person or associated foreign persons which would result in a holding of 15 per cent or more of the issued shares, voting power or potential voting power in South32 requires notification, review and approval by the Treasurer of the Commonwealth of Australia;
- non-associated foreign persons which would result in a holding by those persons (together with an associate or associates of any of them) of 40 per cent or more of the issued shares, voting power or potential voting power in South32 can be the subject of certain orders (including prohibition) by the Treasurer of the Commonwealth of Australia if the Treasurer considers the result would be contrary to the national interest.

Any acquisition of South32 Shares by a foreign government or one of its related entities may also require notification, review and approval under the Foreign Investment Review Board's policy (**Policy**).

The Treasurer has confirmed that he does not object to the actions to be taken as part of implementation of the Demerger (as described in Section 14).

Persons who consider that they may be affected by the FATA or the Policy should seek independent professional advice.

15.9 SOUTH AFRICAN EXCHANGE CONTROL LIMITATIONS AFFECTING SHARES

The following is a general summary of the current position, and is intended as a guide only and is therefore not comprehensive. Persons who consider that they may be affected by South Africa's exchange control limitations in relation to their South32 Shares should seek independent professional advice. South32 is not responsible for obtaining any exchange control consents that any investor may need to obtain, in order to buy or sell South32 Shares.

(a) General SARB requirements

South32 Shareholders' attention is drawn to the SARB's requirements that all share transactions pertaining to South32 Shares registered on the South African overseas branch register will be subject to South African tax legislation that is already in force or which may come into force.

(b) Inward listing on the JSE

South32 has obtained SARB approval for the secondary (inward) listing of South32 Shares on the JSE subject to certain conditions and undertakings set out in Section 15.10(d). The SARB approval specifically provides for the following:

- the approval of the inward listing of the South32 Shares on the JSE;
- South32's Shareholders that are residents of South Africa will be treated according to the provisions of section H.(A) of the Exchange Control Rulings following the secondary (inward) listing of the South32 Shares on the JSE.

Upon the listing of the South32 Shares on the JSE, the Exchange Control Regulations provided for in section H of the Exchange Control Rulings will apply to the acquisition of South32 Shares by South African residents.

South32 Shareholders who are required to dispose of their South32 Shares within a stipulated period should consult their broker or other professional adviser immediately. South32 Shareholders that are uncertain of whether the SARB will allow them to retain their South32 Shares should consult their broker or other professional adviser immediately.

The following is a summary of exchange controls insofar as they have application to South African resident South32 Shareholders in relation to the holding of South32 Shares. This summary description is intended as a guide only and is therefore not comprehensive. If you are in any doubt, you should consult an appropriate professional adviser immediately.

(c) South African individuals

South African individuals will be able to acquire South32 Shares on the South32 South African branch register or via the JSE through Strate, without restriction. Consequently, the purchase of South32 Shares by a South African individual will not affect such person's offshore investment allowance. A South African individual need not take any additional administrative actions and can instruct their broker to accept, buy and sell South32 Shares on their behalf as they would with any other listed security on the JSE.

(d) South African institutional investors

Institutional investors are allowed to invest in inward listed shares without affecting their permissible foreign portfolio investment allowance.

(e) Member brokers of the JSE

A special dispensation has, in terms of section H.(E) of the SARB's Exchange Control Rulings, been provided to local brokers to facilitate the trading of inward listed shares on the JSE. South African brokers are now allowed, as a book building exercise, to purchase shares offshore and to transfer them to the South African overseas branch register. This special dispensation is confined to shares of inward listed companies, and brokers may warehouse such shares for a maximum period of 30 days.

(f) South African corporate entities and trusts

South African corporate entities or trusts will be able to acquire South32 Shares on the South African overseas branch register, via the JSE, without restriction. A South African corporate entity or trust need not take any additional administrative actions and can instruct their broker to accept, buy and sell South32 Shares on its behalf as they would with any other listed security on the JSE.

(g) Rights issue

South African institutional investors, corporates, banks, trusts, partnerships and private individuals will be allowed to exercise their rights in terms of rights offers by South32.

(h) Non-residents of the CMA

Non-residents of the CMA may acquire South32 Shares on the JSE provided that payment is received in ZAR from a non-resident account. Proceeds from the sale of South32 Shares by non-residents are freely transferable. Former residents of the CMA who have emigrated may use emigrant blocked funds to acquire South32 Shares, provided that these are endorsed accordingly and brought under the physical control of an authorised dealer appointed by the Minister of Finance of South Africa in terms of the Exchange Control Regulations who controls the said emigrants' remaining blocked assets.

15.10 ASX, ASIC, JSE AND SARB WAIVERS, CONFIRMATIONS AND RELIEF

(a) ASIC waivers

ASIC has granted relief from:

- the requirement to prepare a prospectus in relation to the invitation to BHP Billiton Shareholders to vote on the Demerger, and in relation to any secondary trading in South32 Shares;
- various provisions in the Corporations Act (including the provisions relating to managed investment schemes and financial services licensing) that may otherwise apply to the Sale Facility;
- the takeover provisions under the Corporations Act in respect of the proposed issue of South32 Shares to BHP Billiton Plc (or a subsidiary) immediately prior to the distribution of those South32 Shares to BHP Billiton Plc Shareholders (including the requirement for BHP Billiton Plc to file a substantial holding notice, if applicable).

(b) ASX confirmations and waivers

The ASX has:

- confirmed for the purpose of ASX Listing Rule 1.1, condition 3 that:
 - South32 may use an information memorandum substantially in the form of this document rather than a prospectus for the purpose of its admission to the ASX and that information memorandum does not need to be sent to South32 Shareholders;
 - the South32 pro forma historical financial information contained in this document may be used for the purpose of the assets test;
- provided waivers in respect of ASX Listing Rule 6.23 in relation to certain adjustments to BHP Billiton's employee share plans to adjust for the effect of the Demerger;
- provided a waiver in respect of ASX Listing Rule 10.14 to allow South32 to issue options or grant rights to executive directors of South32 pursuant to the terms of the South32 Equity Incentive Plan for the purpose of adjusting for the effect of the Demerger on the executive directors' BHP Billiton options or rights;
- confirmed that ASX Listing Rule 10.1 does not apply to the transfer of South32 Shares to any of BHP Billiton's substantial shareholders or BHP Billiton directors;
- confirmed that ASX Listing Rules 7.1 and 10.11 do not apply to the issue of 40 per cent of the South32 Shares to BHP Billiton Plc immediately prior to the distribution of South32 Shares to BHP Billiton Plc Shareholders;
- confirmed that ASX Listing Rules 7.1 and 10.11 do not apply to the issue of any South32 Shares to BHP Billiton Limited for the purpose of adjusting the number of South32 Shares on issue immediately prior to implementation of the Demerger;
- confirmed that Chapter 11 of the ASX Listing Rules does not apply to the Demerger and the approval of BHP Billiton Limited Shareholders is not required for the Demerger;
- approved the timetable for the Demerger.

(c) JSE confirmations and waivers

The JSE has provided certain confirmations and waivers in connection with the Demerger and this document.

(d) SARB confirmations and waivers

The SARB has approved the inward listing of South32 on the JSE for the purposes of allowing South32 Shareholders that are residents of South Africa to be treated according to the provisions of section H of the South African Exchange Control Rulings, subject to the conditions set out below. South32 has agreed to these conditions, which it does not believe will have a material impact on its business. The conditions are set out below:

- The board of directors of South32 must have a minimum of two South African representatives.
- The shares owned by South African shareholders in South32 must be held on the JSE register, subject to the current requirements relating to inward listings.
- After the demerger:
 - only South32 shareholders not being South African residents will be permitted to transfer ASX or LSE listed shares to the JSE and vice versa;
 - any South African person (including any institutional South African investor) who wishes to acquire South32 Shares on either the ASX or LSE register will be entitled to do so only in accordance with the usual exchange control principles applicable to the acquisition of foreign shares – any shares so acquired will be regarded as foreign shares and be subject to the limits applicable to the allowance of foreign assets in respect of such person.

- South32 will not be required to obtain the prior written consent of the FinSurv Department for capital raising exercises in South Africa in cases where:
 - the capital raising in question is undertaken by way of a vanilla pro rata rights offer to all shareholders; and
 - there are no special agreements between South32 and one or more non-South African resident shareholders that they will not take up their rights in the rights offer.
- South32 will be required to obtain the prior written consent of the FinSurv Department in respect of any proposed issue of shares in South32 pursuant to a capital raising under which a greater than pro rata share of that capital raising is to be targeted towards South African resident shareholders (whether new or pre-existing).
- South32 will have the right to pay dividends from its South African subsidiaries and to remit any such dividends abroad without having to obtain the prior written consent of the FinSurv Department, provided that the payout ratio of dividends from the distributable reserves of the South African subsidiaries shall be no greater than the average payout ratio of dividends from the distributable reserves of non-South African subsidiaries.
- South32 must furnish the FinSurv Department with a performance report showing compliance with the aforesaid conditions, together with its financial statements, on an annual basis.
- All trade marks developed in South Africa must remain in South Africa.

In addition, South32 has given the following undertakings to the FinSurv Department:

- The board and management team of South32 will include strong South African representation.
- South32 board meetings will be regularly convened in South Africa.
- South32's African operations will be managed from a regional head office in South Africa.
- To the extent possible, a South African citizen will be appointed to lead the African businesses and will be based in South Africa.
- A global shared services centre which provides support to South32 operations will be established and managed from the regional office.
- South32 will declare dividends in proportion to its earnings and will not excessively leverage its South African operations.

Save as set out above, the normal exchange control principles and rules relating to inward listed companies will be applicable to South32.

15.11 GOVERNMENT PROTECTIONS AND INVESTMENT ENCOURAGEMENT LAWS

In the context of the South32 Group taken as a whole, the South32 Group is not the beneficiary of any material governmental protections, investment encouragement laws or incentives, which are not of general application, except as described in Section 7.1.

15.12 ORGANISATIONAL STRUCTURE

After implementation of the Demerger, it is intended that the South32 Group will comprise South32 and its subsidiaries. South32 is expected to hold the following significant subsidiaries (not including dormant and non-trading entities) and material joint venture interests and investments at the ASX Listing Date:

Table 15.3: List of South32's significant subsidiaries, incorporated joint venture interests and investments

Subsidiary name	Place of incorporation	South32 shareholding ^(a)	Proportion of voting rights ^(b)
BHP Billiton Aluminium (RAA) Pty Ltd ^(c)	Australia	100	100
BHP Billiton Aluminium (Worsley) Pty Ltd ^(c)	Australia	100	100
BHP Billiton Cannington Pty Ltd	Australia	100	100
BHP Billiton Corporate Overheads Pty Ltd	Australia	100	100
BHP Billiton Energy Coal South Africa Proprietary Limited	South Africa	90	90
BHP Billiton Finance South Africa Limited	British Virgin Islands	100	100
BHP Billiton Freight Australia Pty Ltd	Australia	100	100
BHP Billiton International Investment Holdings Pty Ltd	Australia	100	100
BHP Billiton Jersey Limited	Jersey	100	100
BHP Billiton Metais SA	Brazil	100	100
BHP Billiton RBM Holdings Proprietary Limited	South Africa	100	100

Subsidiary name	Place of incorporation	South32 shareholding ^(a)	Proportion of voting rights ^(b)
BHP Billiton Royalty Investments Pty Ltd	Australia	100	100
BHP Billiton SA Finance (Pty) Limited	South Africa	100	100
BHP Billiton SA Holdings Limited	South Africa	100	100
BHP Billiton SA Investments Limited	United Kingdom	100	100
BHP Billiton SA Limited	South Africa	100	100
BHP Billiton Singapore Pte Ltd	Singapore	100	100
BHP Billiton Treasury Limited	Australia	100	100
BHP Billiton Treasury (USA) Limited	Australia	100	100
BHP Billiton Worsley Alumina Pty Ltd ^(c)	Australia	86	86
Billiton Aluminium SA (Pty) Limited	South Africa	100	100
Billiton Coal SA Proprietary Limited	South Africa	100	100
Billiton Investment 12 B.V.	Netherlands	100	100
Cerro Matoso SA	Colombia	99.9	99.9
Dendrobium Coal Pty Ltd	Australia	100	100
Endeavour Coal Pty Ltd	Australia	100	100
Gengro Limited	South Africa	100	100
Groote Eylandt Mining Company Pty Ltd ^(c)	Australia	60	60
Hillside Aluminium (Pty) Limited	South Africa	100	100
Hotazel Manganese Mines (Proprietary) Limited	South Africa	74	44.4
Illawarra Coal Holdings Pty Ltd	Australia	100	100
Illawarra Services Pty Ltd	Australia	100	100
Mozal SARL ^(c)	Mozambique	47.1	47.1
Phola Coal Processing Plant Proprietary Limited	South Africa	50	45
Samancor AG	Switzerland	60	60
Samancor Manganese (Proprietary) Limited	South Africa	100	60
Tasmanian Electro Metallurgical Company Pty Ltd ^(c)	Australia	100	60

(a) South32's percentage shareholding represents the percentage of shares held by a member of the South32 Group.

(b) South32's proportion of voting rights in a company is determined by multiplying the percentage voting rights in each company between South32 and the relevant company.

(c) As at the date of publication of this document, the interests specified in respect of these companies are not owned by South32. South32 expects to own the interest specified in these companies following implementation of the Demerger.

15.13 DETAILS ON SOUTH32 DIRECTORS AND SENIOR MANAGEMENT

The Directors and their functions within South32 and brief biographies are set out in Section 8.1.

The companies and partnerships of which the South32 Directors are, or have, within the past five years, been members of the administrative, management or supervisory bodies or partners (excluding South32 and its subsidiaries):

Table 15.4: Current and former directorships for South32 Directors and senior management

David Crawford Chairman and Independent Non-executive Director		
Current directorship/ partnership	Australia Pacific Airports Corporation Limited (Chairman)	Melpeat Pty Ltd
	Lend Lease Corporation Limited (Chairman)	
Former directorship/ partnership	Beringer Blass Wines Pty Ltd	Gardiner Hill Pty Ltd
	BHP Billiton Limited	Kaprad Holdings Pty Ltd
	BHP Billiton Plc	LLIT Pty Ltd
	Foster's Group Limited	Melbourne Cricket Club Foundation Scotch College

Other relevant roles	<p>Allens (formerly Allens Arthur Robinson (current member of the Advisory Board))</p> <p>Australia Pacific Airports Corporation Limited (current member of the Remuneration Committee)</p> <p>Bank of America Merrill Lynch Australia (current member of Advisory Board)</p> <p>BHP Billiton Group (former Chairman of the Finance Committee)</p> <p>Chelmanness Pty Ltd (former Receiver/ Manager)</p>	<p>Foster's Group Limited (former Chairman of the Succession Committee, former member of the Audit Committee, former member of the Human Resources Committee)</p> <p>Lend Lease Corporation Limited (current member of the Nomination Committee)</p> <p>Melbourne Cricket Club Foundation (former Vice President)</p>
Graham Kerr Chief Executive Officer and Executive Director		
Former directorship/ partnership	<p>Richards Bay Mining (Proprietary) Limited</p> <p>Richards Bay Mining Holdings (Proprietary) Limited</p> <p>Richards Bay Titanium (Proprietary) Limited</p>	<p>Richards Bay Titanium Holdings (Proprietary) Limited</p> <p>Tisand (Pty) Limited</p>
Other relevant roles	BHP Billiton Group (former Chief Financial Officer and former member of management committee)	Iluka Resources Ltd (former General Manager Commercial)
Keith Rumble Independent Non-executive Director		
Current directorship/ partnership	<p>Acetologix Pty Limited</p> <p>BHP Billiton Limited</p> <p>BHP Billiton Plc</p>	<p>Elite Wealth (Pty) Limited</p> <p>Enzyme Technologies (Pty) Limited</p>
Former directorship/ partnership	Aveng Group Limited	
Other relevant roles	<p>BHP Billiton Group (current member of the Sustainability Committee)</p> <p>Parkview Golf Club (former Committee member)</p>	<p>Rhodes University (current member of the Board of Governors)</p> <p>World Wildlife Fund, South Africa (current trustee)</p>
Xolani Mkhwanazi Non-executive Director		
Current directorship/ partnership	<p>3G Investment Holdings</p> <p>Bombardier Transportation South Africa Pty Ltd</p> <p>Clyromanzi Pty Ltd</p> <p>Comverge South Africa (Pty) Limited</p> <p>EB Steam Holdings (Pty) Limited</p> <p>Entabeni Bayside Development Company</p> <p>Entabeni Bayside Management Company</p> <p>Friedshelf 1555</p> <p>Idada Trading 354</p> <p>Imphandze Investment Holdings</p> <p>Jan Harmsgat</p> <p>K2014190525</p> <p>K2104187034</p>	<p>Laastewater Plase</p> <p>Logisticor</p> <p>Mkhwanazi Malherbe (M2) Investments</p> <p>Next Corporate and Travel Solutions</p> <p>Phathela Investments</p> <p>Private Label Promotion</p> <p>PSC the Grove</p> <p>Sancrodox</p> <p>Seaworld Investment Holdings</p> <p>The Bridal Entourage</p> <p>Umthombo Exhibitions Events and Promotions</p> <p>Vexosol Pty Ltd</p> <p>Zini River Estate Homeowners Association</p>
Dr Mkhwanazi has notified his intent and is in the process of resigning from the following entities:		
	<p>Alvipart</p> <p>Cyber Knowledge Systems Holdings</p> <p>Cyber Knowledge Systems Investments</p> <p>Eco Electrica (Pty) Limited</p> <p>Eco Emfuleni (Pty) Limited</p>	<p>Guild Sibanye Investments</p> <p>Gypsum Fertilizer Company</p> <p>Interactive Trading 779</p> <p>Rift Valley Investment</p> <p>Sofitone</p>

Former directorship/ partnership	Bubesi Investments 188	Richards Bay Titanium (Proprietary) Limited
	Bytes Universal Systems	Richards Bay Titanium Holdings (Proprietary) Limited
	Joshua Nxumalo Investments	Serengeti Jewellers
	Kabi Energy	Summit Diamond Cutting
	NBI - National Business Initiative for Growth Development and Democracy	Summit Jewellers
	Pebble Bed Modular Reactor Company	Tisand (Pty) Limited
	Richards Bay Mining (Proprietary) Limited	Umfede Investments
	Richards Bay Mining Holdings (Proprietary) Limited	Unisys Africa Pty Ltd
	Other relevant roles	At Snowy's Guest House (former member)
Human Resource Development Council of South Africa (current member)		Nelson Mandela Municipality University Trust (current trustee)
Jan Harmsgat Farm (current member)		Projects Sibanye Tendering (former member)
Jan Harmsgat Live Stock Division (former member)		Shamase Guesthouse (former member)
Largovert (current member)		South Africa Chamber of Mines (current member of council and former President)

With the exception of Nicole Duncan, who was a former director or company secretary of certain subsidiaries of the BHP Billiton Group, none of the senior managers listed in Section 8.2 are, or have, within the past five years, been members of the administrative, management or supervisory bodies, or partners of, a company or partnership (except as set out in Section 8.2).

15.14 PENSIONS

(a) Defined contribution pension plans and multi-employer pension plans

The South32 Group contributes to defined contribution plans and multi-employer defined contribution plans in Australia, Brazil, Mozambique, Singapore, South Africa, Switzerland and the United Kingdom. Contributions to these plans are expensed as incurred.

The plans are described in more detail in note 25 Related party balances and transactions of Annexure 1.

(b) Defined benefit pension plans

All defined benefit plans are closed to new entrants. Defined benefit pension plans remain operating in Australia, Brazil and South Africa for existing members.

The defined benefit pension plans are final salary plans that provide final salary benefits only, or mixed benefit plans that consist of a final salary defined benefit portion and a defined contribution portion.

Full actuarial valuations are prepared and updated annually to 30 June by local actuaries for all plans, using the projected unit credit valuation method.

The South32 Group does not usually participate in multi-employer defined benefit plans, in which the risks are shared with other companies that participate in those plans.

(c) Defined benefit post-retirement medical plans

The South32 Group operates a number of post-retirement medical plans in South Africa. Full actuarial valuations are prepared by local actuaries for all plans. All of the post-retirement medical plans in the South32 Group are unfunded.

15.15 LITIGATION

Members of the South32 Group are involved from time to time in governmental, legal or arbitration proceedings of a character normally incidental to their business, including claims and pending actions against South32 Group members seeking damages or clarification of legal rights and regulatory inquiries regarding business practices.

There are no, nor have there been any, governmental, legal or arbitration proceedings (including any such proceedings which are pending or threatened of which South32 is aware) which may have, or have had in the recent past, being the 12 months preceding the date of this document, a significant effect on South32 and/or the South32 Group's financial position or profitability, except for certain actions brought:

- in respect of Cerro Matoso, which are referred to in Section 2.1(f);
- by administrative bodies, which are referred to in Section 2.1(d).

These matters are being vigorously contested by South32. There are other litigation and arbitration proceedings to which members of the South32 Group are a party that are not considered to be material to South32. However, it is possible that South32's assessment of its exposure in respect of these proceedings may change in the future, including as a result of developments in the proceedings or additional information becoming available.

15.16 MATERIAL CONTRACTS

The following contracts (not being contracts entered into in the ordinary course of business) are contracts which have been entered into by the South32 Group in the two years immediately prior to the date of this document, and which are or may be material or are contracts entered into by the South32 Group which contain provisions under which any member of the South32 Group has an obligation or entitlement which is or may be material to the South32 Group at the date of this document:

- the Implementation Deed, the terms of which are summarised in Section 14.4(a);
- the Separation Deed, the terms of which are summarised in Section 14.4(b);
- the Cash Adjustment Agreement, the terms of which are summarised in Section 14.4(c);
- the Transitional Services Agreement, the terms of which are summarised in Section 14.4(d);
- the Subscription Agreement, the terms of which are summarised in Section 14.2;
- the Facility, the terms of which are summarised in Section 10.6;
- the agreements entered into by South32 described in Section 7.3(d) in respect of the Manganese Business Entities;
- the Cerro Matoso IPA, the terms of which are summarised in Section 7.1(i)(1);
- the ADS Depositary Agreement;
- the Deed Poll;
- the DI Depositary Agreement;
- the CSN Agreement.

No other material contracts, other than in the ordinary course of business, were entered into within the two years preceding the last practicable date prior to the publication of this document or before that date and which remain outstanding in any respect.

15.17 MATERIAL ROYALTIES

Royalties and resource rent taxes are treated as income tax when they have the characteristics of a tax on profits. Obligations arising from royalty arrangements that are based on turnover do not satisfy these criteria and are treated as expenses. Except as disclosed in this document (including Annexure 6), no individual royalties which are material to South32 (as defined by the listing requirements of the JSE) have been paid by the South32 Group in the three years preceding the date of this document.

15.18 PROPERTY, PLANT AND EQUIPMENT

South32's material assets comprise its mining titles, leases and options, and its preparation plants and processing refineries, smelting, and infrastructure which are discussed in Section 7.1 and Annexure 6. Material environmental issues which affect the use of these assets are discussed in Sections 2.5 and 7.1.

In addition, South32 owns, leases or licences certain properties for its business operations around the world.

15.19 SIGNIFICANT CHANGE

There has been no significant change in the financial or trading position of the South32 Group since 31 December 2014, being the date the historical combined financial information referred to in Section 9 of this document was prepared, except as disclosed in note 10 Subsequent events in Annexure 2 of this document.

15.20 WORKING CAPITAL STATEMENT

South32 and its directors are of the opinion that the South32 Group has sufficient working capital for its present requirements, that is, for at least the next 12 months from the date of the publication of this document.

15.21 ANNOUNCEMENT OF COMPLETION OF THE DEMERGER AND THE ADMISSION OF SOUTH32 SHARES

An announcement will be made on the ASX and JSE upon South32's admission to the ASX and JSE respectively, and to a Regulatory Information Service on admission of South32 to trading on the LSE.

15.22 CONSENTS

Each of the parties named in Section 15.22 as consenting parties:

- has given and has not, before the date of this document, withdrawn its written consent to be named in this document in the form and context in which it is named;
- has given and has not, before the date of this document, withdrawn its written consent to the inclusion of its respective statements and reports (where applicable) noted next to its names in Section 15.22, and the references to those statements and reports in the form and context in which they are included in this document;
- does not make, or purport to make, any statement in this document other than those statements referred to in Section 15.22 in respect of that person's name (and as consented to by that person);
- to the maximum extent permitted by law (but without prejudice to its obligations under the UKLA Prospectus Rules), expressly disclaims and takes no responsibility for any statements in or omissions from this document.

Table 15.5: Parties that have consented to be named

Role	Consenting party
Auditor	KPMG and KPMG Inc.
Registry	Computershare Investor Services Pty Limited. Computershare Investor Services (Pty) Limited. Computershare Investor Services PLC.
Legal advisers	Herbert Smith Freehills (Australia), ENSafrica (South Africa), Slaughter and May (United Kingdom) and Cleary Gottlieb Steen & Hamilton LLP (United States).
Independent legal advisers to South32	King & Wood Mallesons (Australia), Weksmans Attorneys (South Africa) and King & Wood Mallesons LLP (United Kingdom).
Financial advisers	Lead financial adviser: Goldman Sachs Australia Pty Ltd. Joint financial adviser and sponsor for the JSE listing: UBS AG.
Taxation advisers	Greenwoods & Herbert Smith Freehills Pty Ltd (Australia), Slaughter and May (United Kingdom), Cleary Gottlieb Steen & Hamilton LLP (United States), Ernst & Young Advisory Services (Pty) Ltd (South Africa) and Bell Gully (New Zealand).
Independent Accountant	KPMG Financial Advisory Services (Australia) Pty Ltd, in relation to the Independent Accountant's Assurance Report, any statements based on that report and for the purpose of PR 5.5.3R(2)(f) of the UKLA Prospectus Rules.
Independent Competent Persons	Each Independent Competent Person named as such in the relevant report set out in Annexure 6 in relation to their report. ^(a)
Competent Persons	Each Competent Person, in relation to the relevant Mineral Resources and Ore Reserves information they have provided, as set out in Section 7.2(b).
Other	Wood Mackenzie in relation to certain statistical information attributed to it in this document relating to the bauxite, alumina and aluminium, energy coal and metallurgical coal industries. CRU in relation to certain statistical information attributed to it in this document relating to the manganese and alumina industries. International Lead Zinc Study Group in relation to certain statistical information attributed to it in this document relating to the silver, lead and zinc industry. AME Group in relation to certain statistical information attributed to it in this document relating to the silver, lead and zinc industry. In each case the information from the "Other" parties has been accurately reproduced from the relevant source and, as far as South32 is aware and is able to ascertain from information published by the "Other" parties, no relevant facts have been omitted which would render the reproduced information being inaccurate or misleading.

(a) An Independent Competent Person's Report has not been prepared for MRN's reserves on the basis that the contribution to South32 (from its 14.8 per cent interest in MRN's reserves on a standalone basis) is not material in the context of South32's overall business. An Independent Competent Person's Report prepared for MRN would not include the value or South32's interest in Alumar and thus would not be representative of the contribution of the Brazil Aluminium business.

15.23 INDEPENDENT COMPETENT PERSONS' AND COMPETENT PERSONS' INTERESTS IN BHP BILLITON SHARES

None of the Independent Competent Persons or Competent Persons:

- holds or has, within the two years prior to the date of this document, held any direct or indirect beneficial interests in any South32 assets or South32 Shares other than interests that are, or may have been, held in BHP Billiton Shares; or
- has acquired, disposed of or leased any South32 asset.

Each Independent Competent Person's and Competent Person's interest in BHP Billiton Shares as at 14 March 2015 (being the latest practicable date prior to the publication of this document) is set out in Tables 15.6 and 15.7 below:

Table 15.6: Independent Competent Persons' interests in BHP Billiton Shares (and therefore indirect interest in South32) as at 14 March 2015

Mine	Consulting firm	Independent Competent Person	Direct interest in BHP Billiton Shares	Indirect interest in BHP Billiton Shares
Worsley Alumina	SRK	Rod Brown	1,100	Nil
		Sjoerd Duim	Nil	Nil
		Anthony Stepcich	Nil	Nil
South Africa Energy Coal	Xstract	Kevin Irving	Nil	114
		Ian de Klerk	Nil	Nil
		Jeames McKibben	Nil	Nil
		Richard Marshall	Nil	Nil
		Graham Trusler	Nil	Nil
Illawarra Metallurgical Coal	RungePincock Minarco	David McMillan	Nil	Nil
		Greg Eisenmonger	Nil	Nil
GEMCO	CSA Global	Bill Shaw	Nil	1,200
		Paddy Reidy	Nil	Nil
Hotazel Mines	CSA Global	Bill Shaw	Nil	1,200
		Paddy Reidy	Nil	Nil
Cerro Matoso	SRK	Danny Kentwell	700	701
		Carl Murray	Nil	Nil
		Anthony Stepcich	Nil	Nil
Cannington	Xstract	Tim Horsley	Nil	Nil
		Matthew Readford	Nil	Nil
		Jeames McKibben	Nil	Nil
		Roland Nice	Nil	983
		Craig Miller	Nil	Nil

Table 15.7: Competent Persons' interests in BHP Billiton Shares (and therefore indirect interest in South32)

Mine	Competent Person	Direct interest in BHP Billiton Shares	Indirect interest in BHP Billiton Shares
Worsley Alumina	J Binoir	99	Nil
	G Burnham	450	Nil
	J Engelbrecht	Nil	Nil
MRN Mine	R Aglinskas	Nil	Nil
	J P de Melo Franco	Nil	Nil
South Africa Energy Coal	G Gemmell	Nil	Nil
	N Haniff	526	Nil
	J H Marais	260	Nil
	P Maseko	296	Nil
	I Thomson	684	Nil
	L Visser	306	Nil
Illawarra Metallurgical Coal	H Kaag	361	Nil
	M Rose	354	Nil
GEMCO	M Bryant	Nil	2,500
	D Hope	1,038	Nil
Hotazel Mines	E P Ferreira	851	Nil
	D Mathebula	2,562	Nil
	C Nengovhela	Nil	Nil
Cerro Matoso	I Espitia	Nil	Nil
	F Fuentes	411	Nil
Cannington	B Coutts	3,034	Nil
	M Dowdell	2,208	Nil

15.24 RELATED PARTY TRANSACTIONS

All transactions with related parties are conducted on an arm's-length basis and in accordance with normal business terms. Transactions between related parties that are South32 subsidiaries are eliminated on consolidation. Details of contractual arrangements with BHP Billiton and its subsidiaries to give effect to the Demerger are described in Section 14.4. Related party matters, including joint ventures, associates, joint operations and transactions with key management personnel of South32, can be found in note 24 Related party balances and transactions to the historical combined financial information in Annexure 1.

Save as disclosed in the historical combined financial information or in Section 14.4, there are no related party transactions between South32 and members of the BHP Billiton Group that were entered into during: (i) the financial years ended 30 June 2012, 2013 and 2014; (ii) the six months ended 31 December 2014; and (iii) the period from 1 January 2015 to 14 March 2015 (being the latest practicable date prior to the publication of this document).

15.25 NO INCORPORATION OF WEBSITE INFORMATION

The contents of the South32 website or any member of the South32 Group's website do not form part of this document.

15.26 COSTS AND EXPENSES

South32 will not receive any proceeds as a result of the Demerger. The total costs and expenses relating to the preparation and issue of this document, legal and professional fees associated with implementing the Demerger and admission to each of the ASX, JSE and LSE will be borne by BHP Billiton.

No amount has been paid or is proposed to be paid by South32 to any promoter, nor has any such amount accrued as payable by South32 within the three years preceding the date of this document.

No commission has been paid or is payable by South32 for underwriting.

No commission, discount, brokerage or special terms have been granted for the issue or sale of any securities, stock or debentures in the capital of South32 in the three years preceding the date of this document.

No South32 Director or promoter has any material direct or indirect beneficial interest in the promotion of South32 or any property acquired or proposed to be acquired by South32 during the three years preceding the date of this document.

15.27 SOURCES AND BASES OF SELECTED FINANCIAL AND OTHER INFORMATION

In this document, unless otherwise stated, financial information relating to South32 has been extracted (without material adjustment) from the historical combined financial information contained in Annexures 1 and 2 or the pro forma financial information contained in Section 10 and Annexure 3.

Where information contained in this document has been sourced from a third party, it has been accurately reproduced and, so far as South32 is aware and is able to ascertain from information published by the relevant third party, no facts have been omitted which would render the reproduced information inaccurate or misleading.

The number of South32 Shares for which application has been made to trading on the ASX, JSE and LSE has been calculated on the basis of 5,323,762,901 BHP Billiton Shares on issue on 14 March 2015 (being the latest practicable date prior to the publication of this document).

Statements relating to percentage interests in the issued share capital of South32 are calculated on the basis of 5,323,762,901 BHP Billiton Shares on issue on 14 March 2015 (being the latest practicable date prior to the publication of this document) and on the assumption that no new BHP Billiton Shares will be issued between that date and the date the Demerger becomes effective.

15.28 DOCUMENTS AVAILABLE FOR INSPECTION

Copies of the following documents may be inspected at the offices of Slaughter and May, One Bunhill Row, London EC1Y 8YY and ENSafrica, 150 West Street, Sandton, Johannesburg 2196, during normal business hours on any weekday (Saturdays, Sundays and public holidays excepted) up to and until South32's United Kingdom Admission:

- (a) the South32 Constitution;
- (b) the historical combined financial information relating to South32 Limited and the Independent Audit Report and the Independent Review Report to the Directors of South32 Limited thereon by KPMG and KPMG Inc, as set out in Annexures 1 and 2 of this document, respectively;
- (c) the pro forma historical financial information and the Independent Accountants Assurance Report for the directors of South32 thereon by KPMG Financial Advisory Services (Australia) Pty Ltd, as set out in Sections 10 and 12 of this document, respectively;
- (d) the Independent Competent Persons' Reports;
- (e) the Tax Experts' Reports;
- (f) the written consent letters of KPMG, KPMG Inc and KPMG Financial Advisory Services (Australia) Pty Ltd, the Independent Competent Persons referred to Section 15.23, the Competent Persons and the Tax Experts;
- (g) the following material contracts, the:
 - ADS Depositary Agreement;
 - Deed Poll;
 - CSN Agreement;
 - DI Depositary Agreement;
- (h) a copy of this document.

This document will be published in electronic form and available on the BHP Billiton website at www.bhpbilliton.com/demerger, subject to certain access restrictions applicable to persons resident outside Australia, South Africa and the United Kingdom. Copies of this document will be available to BHP Billiton Shareholders in printed form free of charge upon request from the Shareholder Information Line.

Dated 16 March 2015

16 DEFINITIONS AND GLOSSARY OF TECHNICAL TERMS

16.1 DEFINITIONS

For the purpose of this document, capitalised terms used in this document have the meaning given below, unless the context requires otherwise (words in the singular include the plural and vice versa):

Term	Meaning
A\$	Australian dollars.
AASB	the Australian Accounting Standards Board.
ADS	American Depositary Share being a share issued under a deposit agreement that has been created to permit United States-resident investors to hold shares in non-US companies and trade them on the stock exchanges or over-the-counter in the United States. ADSs are evidenced by American Depositary Receipts, or ADRs.
ADS Depositary Agreement	the agreement between South32 and Citibank, N.A., as depositary, and the holders and beneficial owners of the ADSs issued thereunder, under which South32 appoints Citibank, N.A. as depositary to provide certain services in respect of the ADS securities issued by South32.
ADS Holder	a holder of an ADS.
AEDT	Australian Eastern Daylight Time.
AEST	Australian Eastern Standard Time.
ASIC	Australian Securities and Investments Commission.
ASX	ASX Limited or the market conducted by it, as the context requires.
ASX Listing Date	the date South32 Shares first commence trading on the ASX, on a deferred settlement basis.
ASX Listing Rules	the rules, as amended from time to time, that govern the admission, quotation, suspension and removal of entities from the ASX Official List.
ASX Official List	the official list of listed entities on the ASX.
ASX Settlement Operating Rules	the operating rules for settlement on the ASX Official List.
Auditor	KPMG and KPMG Inc.
AWST	Australian Western Standard Time.
BBBEE	has the meaning given in Section 5.1.
BBSW	Bank Bill Swap Rate.
BHP Billiton	BHP Billiton Limited and/or BHP Billiton Plc as the context requires.
BHP Billiton ADSs	BHP Billiton Limited ADSs and BHP Billiton Plc ADSs, as applicable.
BHP Billiton ADS Holder	a holder of BHP Billiton ADSs.
BHP Billiton Board	the board of directors of BHP Billiton.
BHP Billiton Businesses	all of the businesses conducted by BHP Billiton, other than the South32 Businesses.
BHP Billiton Group	BHP Billiton Limited and BHP Billiton Plc, and each of their respective subsidiaries.
BHP Billiton Limited	BHP Billiton Limited (ACN 004 028 077).
BHP Billiton Limited ADSs	ADSs representing BHP Billiton Limited Shares.
BHP Billiton Limited Distribution Date	has the meaning given in Section 4.
BHP Billiton Limited Share	a fully paid ordinary share in the capital of BHP Billiton Limited.
BHP Billiton Limited Share Register	the register of BHP Billiton Limited Shareholders maintained under section 169 of the Corporations Act.
BHP Billiton Limited Shareholder	a registered holder of a BHP Billiton Limited Share.
BHP Billiton Plc	BHP Billiton Plc (registered in England and Wales, with registered number 03196209).
BHP Billiton Plc ADSs	ADSs representing BHP Billiton Plc Shares.
BHP Billiton Plc Certificated Shareholder	a holder of a BHP Billiton Plc Share who holds that share in certificated form and whose shareholding is not recorded in the South African branch register.

Term	Meaning
BHP Billiton Plc Dematerialised Shareholders	holder of a Dematerialised BHP Billiton Plc Share.
BHP Billiton Plc Distribution Date	has the meaning given in Section 4.
BHP Billiton Plc Share	a fully paid ordinary share in the capital of BHP Billiton Plc.
BHP Billiton Plc Share Register	the register of BHP Billiton Plc Shareholders maintained pursuant to section 113 of the Companies Act 2006.
BHP Billiton Plc Shareholder	a registered holder of a BHP Billiton Plc Share, excluding a BHP Billiton Plc Dematerialised Shareholder.
BHP Billiton Share	a BHP Billiton Limited Share and/or BHP Billiton Plc Share.
BHP Billiton Shareholder	BHP Billiton Limited Shareholder and/or a BHP Billiton Plc Shareholder.
BMSA	has the meaning given in Section 2.1(d).
BST	British Summer Time.
Cash Adjustment Agreement	the Cash Adjustment Agreement entered into on or around the date of this document between BHP Billiton Limited and South32 as summarised in Section 14.4(c)
CHESS	the Clearing House Electronic Subregister System, managed by ASX Settlement Pty Limited.
CIF	cost insurance and freight.
CMA	the common monetary area of Lesotho, Namibia, South Africa and Swaziland.
CMSA	has the meaning given in Section 2.1(d).
Coal Reserves	has same meaning as Ore Reserves, but specifically concerning coal.
Companies Act 2006	the Companies Act 2006 of England and Wales.
Competent Persons	the persons listed in Section 7.2(b) that have prepared the estimate of Mineral Resources and Ore Reserves set out in Section 7.2, each of whom is a minerals industry professional who is a Member or Fellow of the Australasian Institute of Mining and Metallurgy, or of the Australian Institute of Geoscientists, or of a Recognised Professional Organisation, as included in a list available on the Joint Ore Reserves Committee and ASX websites.
Computershare	Computershare Investor Services Pty Limited, Computershare Investor Services (Pty) Limited or Computershare Investor Services PLC, as applicable.
Computershare Australia	Computershare Clearing Pty Limited.
Corporate Sponsored Nominee or CSN	the UK Nominee as nominee holding South32 DIs on behalf of certain Eligible BHP Billiton Plc Shareholders, as further set out in Section 15.6(e).
Corporations Act	the Corporations Act 2001 (Cth) of Australia.
CREST	the relevant system (as defined in the CREST Regulations) in respect of which Euroclear UK and Ireland Limited is the Operator (as defined in the CREST Regulations).
CREST member	a person who has been admitted to Euroclear UK as a system member (as defined in the CREST Regulations).
CREST participant	a person who is, in relation to CREST, a system participant (as defined in the CREST Regulations).
CREST Regulations	the Uncertificated Securities Regulations 2001 (SI 2001/3755), as amended.
CRU	CRU Group: Global Commodity Industry Pricing & Marketing Analysis.
CSDP	a Central Securities Depository Participant, a participant as defined in section 1 of the Financial Markets Act 19, of 2012 (South Africa).
CSN Agreement	the agreement in relation to nominee service between the UK Depository and South32, summarised in Section 15.6(e)(1) pursuant to which the UK Depository will provide the CSN Facility to CSN Participants.
CSN Facility	the facility arranged by South32 with the UK Depository to enable BHP Billiton Plc Certificated Shareholders to receive their interests in South32 Shares in a form which will enable them to trade those shares and admit the shares to trading on the LSE, as described in Section 15.6(e)(1).
CSN Participant	a participant in the CSN Facility.
CSN Restricted Jurisdictions	the jurisdictions detailed in the CSN Terms and Conditions in which participation in the CSN Facility is not permitted.

Term	Meaning
CSN Terms and Conditions	the terms and conditions under which Computershare Investor Services PLC provides the CSN Facility, as amended from time to time, which are summarised in Section 15.6(e), a copy of which is made available on the BHP Billiton website at www.bhpbilliton.com/demerger and which will be available on the South32 website in due course.
CY	calendar year ending 31 December.
Deed Poll	the Deed Poll made by the UK Depositary constituting the South32 DIs, described in Section 15.6(d), a copy of which is available on the BHP Billiton website at www.bhpbilliton.com/demerger and will be available on the South32 website in due course.
Dematerialised	the process by which certificated shares are deposited with a CSDP and documents of title evidencing such certificated shares are replaced by an electronic record of such shares in the Strate Nominee Register.
Dematerialised BHP Billiton Plc Share	a BHP Billiton Plc Share that has been Dematerialised or has been issued in Dematerialised form, and is held on the Strate Nominee Register.
Demerger	the proposed demerger of South32 from BHP Billiton, to be implemented through the Demerger Dividend.
Demerger Dividend	the BHP Billiton Limited Dividend and the BHP Billiton Plc Dividend referred to in section 7 of the Shareholder Circular.
Demerger Principle	the fundamental underlying principle of the Demerger, as set out in Section 14.4(b).
Demerger Resolution	the ordinary resolution to be voted on by BHP Billiton Shareholders to approve the Demerger, as set out in the Notice of Meeting which accompanies the Shareholder Circular.
Depositary Interest or DI	has the meaning given in Section 15.6(d)(1).
DI Depositary Agreement	the agreement summarised in Section 15.6(d)(1) pursuant to which South32 has appointed Computershare Investor Services PLC to constitute and issue South32 DIs under the terms of the Deed Poll.
Distribution Date	the BHP Billiton Limited Distribution Date or BHP Billiton Plc Distribution Date (as applicable) and, for the purpose of Section 14, the later of these dates will apply.
EBIT	earnings before interest and tax.
EBITDA	earnings before interest, tax, depreciation and amortisation.
Economic Separation Date	23 May 2015, being the date on which BHP Billiton and South32 will separate for economic purposes.
EDT	Eastern Daylight Time.
Eligible BHP Billiton Limited Shareholder	a BHP Billiton Limited Shareholder as at the applicable Record Date whose registered address on the BHP Billiton Limited Share Register is in Australia, the United Kingdom, South Africa, the United States, Alderney, Canada, Chile, France, Guernsey, Hong Kong, Ireland, Isle of Man, Jersey, Lesotho, Malaysia, Namibia, New Zealand, Singapore or Swaziland or any other jurisdiction in which BHP Billiton reasonably believes that it is not prohibited or unduly onerous or impractical to transfer or distribute South32 Shares to the BHP Billiton Limited Shareholder.
Eligible BHP Billiton Plc Shareholder	a BHP Billiton Plc Shareholder as at the applicable Record Date whose registered address on the BHP Billiton Plc Share Register is in Australia, the United Kingdom, South Africa, the United States, Alderney, Canada, Chile, France, Guernsey, Hong Kong, Ireland, Isle of Man, Jersey, Lesotho, Malaysia, Namibia, New Zealand, Singapore or Swaziland or any other jurisdiction in which BHP Billiton reasonably believes that it is not prohibited or unduly onerous or impractical to transfer or distribute South32 Shares to the BHP Billiton Plc Shareholder.
Eligible Shareholder	an Eligible BHP Billiton Limited Shareholder and/or Eligible BHP Billiton Plc Shareholder.
EST	Eastern Standard Time.
Exchange Act	United States' Securities Exchange Act of 1934.
Exchange Control Regulations	the Exchange Control Regulations, 1961, as amended, promulgated in terms of section 9 of the South African Currency and Exchanges Act, No. 9 of 1933, as amended or replaced from time to time.
Exchange Control Rulings	the rulings issued by the FinSurv Department from time to time in terms of the Exchange Control Regulations.
Facility	has the meaning given in Section 10.6.

Term	Meaning
FCA or Financial Conduct Authority	the Financial Conduct Authority of the United Kingdom.
FinSurv Department	Financial Surveillance department of SARB.
former BHP Billiton Businesses	businesses carried on by any member of the BHP Billiton Group prior to the Demerger, other than the South32 Businesses and the former South32 Businesses.
former South32 Businesses	former businesses previously carried on by the South32 Businesses prior to the Demerger.
FOB	free on board.
FSMA	the Financial Services and Markets Act 2000 of the United Kingdom.
FTE	full-time equivalent.
FTSE	Financial Times Stock Exchange.
FY	refers to the financial year ending 30 June.
GEMCO	has the meaning given in Section 1, B.3.
General Meetings	the general meetings of BHP Billiton Shareholders to consider the Demerger Resolution set out in the notices of general meetings despatched with the Shareholder Circular and to be held on 6 May 2015 for BHP Billiton Limited at 4:30pm (AWST) and 6 May 2015 for BHP Billiton Plc at 9:30am (GMT) and any adjournment thereof.
GMT	Greenwich Mean Time.
H1	first half year, ending 31 December of the relevant financial year.
Hotazel Mines	has the meaning given in Section 1, B.3.
HSEC	health, safety, environment and community.
IASB	International Accounting Standards Board.
IFRS	<ul style="list-style-type: none"> • Australian Accounting Standards, being Australian equivalents to International Financial Reporting Standards and interpretations as issued by the Australian Accounting Standards Board; • International Financial Reporting Standards and interpretations as adopted by the European Union; and • International Financial Reporting Standards and interpretations as issued by the IASB, collectively referred to as IFRS.
Implementation Deed	the Implementation Deed entered into on or around the date of this document between BHP Billiton Limited, BHP Billiton Plc and South32 referred to in Section 14.4(a).
Independent Accountant	KPMG Financial Advisory Services (Australia) Pty Ltd.
Independent Accountant's Assurance Report	the report prepared by the Independent Accountant and included in Section 12.
Independent Audit Report	the audit report prepared by KPMG in respect of the historical combined financial information contained in Annexure 1.
Independent Competent Persons	each Independent Competent Person named as such in the relevant report set out in Annexure 6.
Independent Competent Person's Report	each of the reports prepared by an Independent Competent Person, which are set out in Annexure 6.
Indicated Resource	that part of a Mineral Resource for which quantity, grade (or quality), densities, shape and physical characteristics are estimated with sufficient confidence to allow the application of Modifying Factors in sufficient detail to support mine planning and evaluation of the economic viability of the deposit.
Inferred Resource	that part of a Mineral Resource for which quantity and grade (or quality) are estimated on the basis of limited geological evidence and sampling. Geological evidence is sufficient to imply but not verify geological and grade (or quality) continuity.
Ineligible Overseas Shareholder	a BHP Billiton Shareholder who is not an Eligible Shareholder.
Internal Restructure	the restructuring of the BHP Billiton Group prior to, and in order to effect, the Demerger, as described in Section 14.2.
ISIN	an International Securities Identification Number.

Term	Meaning
JORC Code	a set of minimum standards, recommendations and guidelines for public reporting in Australasia of Exploration Results, Mineral Resources and Ore Reserves. The guidelines are defined by the Australasian Joint Ore Reserves Committee (JORC), which is sponsored by the Australian mining industry and its professional organisations.
JSE	JSE Limited or the market conducted by it, as the context requires.
JSE Guarantee Fund	JSE Guarantee Fund Trust, with Master's reference number IT 9150/2003, a trust established and administered in accordance with guarantee fund rules of the JSE.
JSE Listing Rules	the listing rules of the JSE.
JSE Record Date	the date for determining entitlement of BHP Billiton Plc Dematerialised Shareholders to South32 Shares distributed to the Strate Nominee under the Demerger.
LBMA	London Bullion Market Association.
Limited Record Date	the date for determining entitlement to South32 Shares of BHP Billiton Limited Shareholders.
LME	The London Metal Exchange.
LSE	London Stock Exchange plc or the market conducted by it, as the context requires.
Manganese Business	South32's interests in South Africa Manganese and Australia Manganese, which are co-owned with Anglo American Plc.
Manganese Business Entities	Samancor Holdings (Pty) Limited, Groote Eylandt Mining Company Pty Limited and Samancor AG, and their respective subsidiaries.
Marketable Coal Reserves	represents beneficiated or otherwise enhanced coal product where modifications due to mining, dilution and processing have been considered; must be publicly reported in conjunction with, but not instead of, reports of Coal Reserves. The basis of the predicted yield to achieve Marketable Coal Reserves must be stated (JORC Code, 2012).
Measured Resource	that part of a Mineral Resource for which quantity, grade (or quality), densities, shape and physical characteristics are estimated with confidence sufficient to allow the application of Modifying Factors to support detailed mine planning and final evaluation of the economic viability of the deposit.
Metalloids	has the meaning given in Section 1, B.3.
Mineral Resource	a concentration or occurrence of solid material of economic interest in or on the Earth's crust in such form, grade (quality) and quantity that there are reasonable prospects for eventual economic extraction. The location, quantity, grade (or quality), continuity and other geological characteristics of a Mineral Resource are known, estimated or interpreted from specific geological evidence and knowledge, including sampling (JORC Code, 2012).
Modifying Factors	considerations used to convert Mineral Resources to Ore Reserves. These include, but are not restricted to, mining, processing, metallurgical, infrastructure, economic, marketing, legal, environmental, social and governmental factors.
MRN Mine	has the meaning given in Section 1, B.3.
MRRT	has the meaning given in Section 3.5.
Official List	the official list of securities listed in the United Kingdom maintained by the UKLA.
Operating unit cost	calculated as revenue less Underlying EBITDA divided by production.
Ore Reserve	the economically mineable part of a Measured and/or Indicated Mineral Resource. It includes diluting materials and allowances for losses, which may occur when the material is mined or extracted and is defined by studies at pre-feasibility or feasibility level as appropriate that include application of Modifying Factors. Such studies demonstrate that, at the time of reporting, extraction could reasonably be justified.
Plc Record Date	the date for determining entitlement to South32 Shares of BHP Billiton Plc Shareholders under the Demerger.
Probable Ore Reserves	the economically mineable part of an Indicated and, in some circumstances, a Measured Resource. The confidence in the Modifying Factors applying to a Probable Ore Reserve is lower than that applying to a Proved Ore Reserve. Consideration of the confidence level of the Modifying Factors is important in conversion of Mineral Resources to Ore Reserves. A Probable Ore Reserve has a lower level of confidence than a Proved Ore Reserve but is of sufficient quality to serve as the basis for a decision on the development of the deposit (JORC Code 2012).

Term	Meaning
Proved Ore Reserve	a Proved Ore Reserve represents the highest confidence category of reserve estimate and implies a high degree of confidence in geological and grade continuity and the consideration of the Modifying Factors. The style of mineralisation or other factors could mean that Proved Ore Reserves are not achievable in some deposits (JORC Code 2012). Implies the highest degree of geological, technical and economic confidence in the estimate at the level of production increments used to support mine planning and production scheduling.
RBCT	has the meaning given in Section 5.1.
Record Date	the Plc Record Date, Limited Record Date or JSE Record Date (as applicable) or, in the case of BHP Billiton ADS Holders, the record date of the relevant underlying BHP Billiton Shares.
Register Election	the right described in Section 15.6(c) for BHP Billiton Shareholders (other than South African Shareholders) to elect to receive their South32 Shares in a manner other than that described in Section 15.6(a).
ROM	has the meaning given in Section 7.1(e)(1)
S&P	means Standard & Poor's Rating Services, a division of The McGraw Hill Companies, Inc. (operating in Australia through Standard & Poor's (Australia) Pty Ltd (ABN 62 007 324 852)) or any successor to its rating business.
SA South32 Shareholder	a South32 Shareholder resident in South Africa.
Sale Agent	the nominee appointed by BHP Billiton to sell or facilitate the sale of the South32 Shares under the Sale Facility and South32 Shares to which Ineligible Overseas Shareholders would otherwise have been entitled.
Sale Facility	the facility available to certain BHP Billiton Shareholders, as described in Section 7.12 of the Shareholder Circular.
SARB	South African Reserve Bank.
SAST	South Africa Standard Time.
Section	a section of this document.
Selling Shareholders	BHP Billiton Shareholders who validly elect to have their South32 Shares sold pursuant to the Sale Facility.
Separation Deed	the Separation Deed entered into on or around the date of this document between BHP Billiton Limited, BHP Billiton Plc and South32 as summarised in Section 14.4(b).
Shareholder Circular	the Shareholder Circular relating to the Demerger dated 16 March 2015.
Shareholder Information Line	the information line set up for the purpose of answering enquiries from BHP Billiton Shareholders in relation to the Demerger, the details of which are set out in Section 3.9.
South32 or Company	South32 Limited and, where the context requires, its subsidiaries from time to time.
South32 ADSs	ADSs represented by South32 Shares.
South32 Board	the board of directors of South32.
South32 Businesses or Businesses	the businesses to be conducted by the South32 Group, as described in this document and, where applicable, any future operations in which South32 will have an interest.
South32 Constitution or South32's Constitution	the constitution of South32 which is summarised in Section 15.4.
South32 Director	a director of South32 listed in Section 8.1 (including the proposed directors listed in that Section), or from time to time following the ASX Listing Date, as the context requires.
South32 DIs or South32 Depository Interests	South32 Depository Interests constituted by the Deed Poll, each representing one South32 Share as described in Section 15.6(d)(2).
South32 Group	South32 and its subsidiaries from time to time, and, as at the date of this document, refers to South32 and all entities that will be subsidiaries of South32 immediately following implementation of the Demerger and for purposes of Section 2, 5 and 7 includes the entities that hold the South32 Businesses.
South32 Marketing	South32's marketing function.
South32 Share	a South32 ordinary share, which, in the case of South32 ordinary shares to be held in CREST will be represented by a South32 DI (and for the purposes of Section 15.4 includes shares of any class which may be issued by South32 in the future).
South32 Share Register	the register of South32 Shares.

Term	Meaning
South32 South African branch register	the register of South African South32 Shareholders who hold their shares in certificated form maintained by South32.
South32 Shareholder	a registered holder of a South32 Share or South32 DI, as the context requires.
South African branch register	the register of South African Shareholders who hold their shares in certificated form maintained by BHP Billiton Plc pursuant to section 129 of the Companies Act 2006.
South African Shareholder	a holder of BHP Billiton Plc Shares in certificated form whose shareholding is registered on the South African branch register or a holder of Dematerialised BHP Billiton Plc Shares.
Strate	Strate Proprietary Limited (Registration Number 1998/022242/06), an electronic settlement environment for transactions to be settled and transfer of ownership to be recorded electronically in South Africa.
Strate Nominee	PLC Nominees Proprietary Limited, a company indirectly wholly owned by Strate, acting as nominee for the holders of Dematerialised BHP Billiton Plc Shares.
Strate Nominee Register	the register of BHP Billiton Plc Dematerialised Shareholders maintained by the Strate Nominee.
Subscription Agreement	has the meaning given in Section 14.2.
Tax Experts	Greenwoods & Herbert Smith Freehills Pty Ltd, Slaughter and May, Cleary Gottlieb Steen & Hamilton LLP, Ernst & Young Advisory Services (Pty) Ltd and Bell Gully.
Tax Expert's Report	each of the reports prepared by a Tax Expert in respect of the descriptions of the tax implications of holding South32 Shares, set out in Section 13.
TEMCO	has the meaning given in Section 1, B.3.
TSR (Total Shareholder Return)	TSR measures the return delivered to shareholders over a certain period through the change in share price and any dividends paid.
Transitional Services Agreement	the Transitional Services Agreement entered into on or around the date of this document between a wholly-owned subsidiary of BHP Billiton Limited and South32 as summarised in Section 14.4(d).
Transnet	Transnet Freight Rail, the South African Government-owned rail freight and port provider.
United Kingdom Admission	the admission of the South32 Shares to the standard listing segment of the Official List and to trading for normal settlement on the LSE's main market for listed securities.
UK Depository	Computershare Investor Services PLC in its capacity as depository for holders of South32 DIs.
UKLA	the Financial Conduct Authority acting in its capacity as the competent authority for the purposes of Part VI of FSMA.
UKLA Listing Rules	the listing rules made by the FCA pursuant to FSMA.
UKLA Disclosure and Transparency Rules	the disclosure and transparency rules made by the FCA pursuant to FSMA.
UKLA Prospectus Rules	the prospectus rules made by the FCA pursuant to FSMA.
UK Nominee	Computershare Company Nominees Limited in its capacity as nominee for CSN Participants.
Underlying Earnings	has the meaning given in Section 3.5.
Underlying EBIT	has the meaning given in Section 3.5.
Underlying EBITDA	has the meaning given in Section 3.5.
US	United States of America.
US\$	US dollar.
VWAP	volume weighted average price.
ZAR	South African rand.

16.2 UNITS OF MEASURE

Bt	billion tonne
Boz	billion ounce
dmt	dry metric tonne
dmtu	dry metric tonne unit
g/t	grams per tonne
GWh	gigawatt hour
ha	hectare
kcal/kg	kilocalories per kilogram
kdmT	thousand dry metric tonne
km	kilometre
kwmt	thousand wet metric tonne
kt	thousand tonne
ktpa	thousand tonne per annum
Mdmt	million dry metric tonne
ML	megalitre
Moz	million ounces
Mt	million tonne
Mtpa	million tonne per annum
mtu	metric tonne unit
MW	megawatt
MWh	megawatt hour
MVA	megavolt ampere
ppm	parts per million

16.3 TERMS USED IN RELATION TO RESERVES AND RESOURCES

Ag	silver
Al ₂ O ₃	alumina
A.Al ₂ O ₃	available alumina
Fe	iron
FeMn	ferromanganese
HCFeMn	high-carbon ferromanganese
MCFeMn	medium-carbon ferromanganese
Met	metallurgical coal
Mn	manganese
Ni	nickel
Pb	lead
SiMn	silicomanganese
SiO ₂	silica
VM	volatile matter
Zn	zinc

16.4 ROUNDING

Figures, amounts, percentages, prices, estimates, calculations of values and fractions in this document are subject to the effect of rounding. Accordingly, the actual calculation of these figures may differ from the figures set out in this document.

ANNEXURES

ANNEXURE 1		215
1	Historical combined financial information	215
1.1	Combined income statement	215
1.2	Combined statement of comprehensive income	216
1.3	Combined balance sheet	217
1.4	Combined cash flow statement	218
1.5	Combined statement of changes in invested capital	219
1.6	Notes to the historical combined financial information	220
1	Accounting policies	220
2	Segment reporting	233
3	Significant items	238
4	Other income	239
5	Expenses	239
6	Net finance costs	240
7	Income tax and deferred tax	240
8	Earnings, dividends and asset information per share	243
9	Trade and other receivables	244
10	Other financial assets	245
11	Inventories	245
12	Property, plant and equipment	246
13	Intangible assets	248
14	Trade and other payables	249
15	Interest bearing liabilities	250
16	Other financial liabilities	250
17	Provisions	251
18	Contingent liabilities	253
19	Commitments	253
20	Notes to the combined cash flow statement	254
21	Subsidiaries	254
22	Interests in joint operations	255
23	Financial risk management	255
24	Related party balances and transactions	267
25	Pension and other post-retirement obligations	268
26	Subsequent events	272
1.7	Independent Auditor Report	273

ANNEXURE 2		275
2	Half Year historical combined financial information	275
2.1	Combined income statement	275
2.2	Combined statement of comprehensive income	276
2.3	Combined balance sheet	277
2.4	Combined cash flow statement	278
2.5	Combined statement of changes in invested capital	279
2.6	Notes to the Half Year historical combined financial information	280
1	Accounting policies	280
2	Segment reporting	281
3	Significant items	285
4	Other income	286
5	Net finance costs	286
6	Income tax and deferred tax	286
7	Earnings, dividends and asset information per share	287
8	Financial risk management – Fair values	288
9	Contingent liabilities	291
10	Subsequent events	291
2.7	Independent Review Report	292
ANNEXURE 3		295
3	South32 pro forma historical consolidated income statement and cash flow statement reconciliation tables	295
3.1	Overview	295
3.2	Reconciliation of pro forma historical consolidated income statement	295
3.3	Underlying Earnings and earnings adjustments	297
3.4	Reconciliation of pro forma historical consolidated cash flow statement	298
ANNEXURE 4		299
	South32 pro forma segment reporting	299
ANNEXURE 5		303
	Selected financial metrics for the past 10 financial years	303
ANNEXURE 6		311
	Independent Competent Persons' Reports	311

ANNEXURE 1

HISTORICAL COMBINED FINANCIAL INFORMATION FOR THE YEARS ENDED 30 JUNE 2014, 30 JUNE 2013 AND 30 JUNE 2012 FOR SOUTH32

The historical combined financial information has been prepared with the objective of presenting, in line with the basis of preparation set out in Section 1.6, the results, net assets and cash flows of the South32 Group ("South32") in the form that will arise immediately following implementation of the Demerger, as if it had been operating on a combined basis throughout the financial periods covered.

1.1 COMBINED INCOME STATEMENT

	Notes	2014 US\$M	2013 US\$M	2012 US\$M
Revenue				
Group production	2	9,182	10,430	11,476
Third party products	2	1,262	1,663	2,359
Revenue	2	10,444	12,093	13,835
Other income	4	310	155	60
Expenses excluding net finance costs	5	(9,990)	(13,211)	(11,835)
Share of operating profit of equity accounted investments		10	-	-
Profit/(loss) from operations		774	(963)	2,060
Comprising:				
Group production		745	(1,026)	1,966
Third party products		29	63	94
Financial income	6	41	130	155
Financial expenses	6	(393)	(263)	(197)
Net finance costs	6	(352)	(133)	(42)
Profit/(loss) before taxation		422	(1,096)	2,018
Income tax expense		(245)	(66)	(781)
Royalty-related taxation (net of income tax benefit)		40	(142)	196
Total taxation expense	7	(205)	(208)	(585)
Profit/(loss) after taxation		217	(1,304)	1,433
Attributable to non-controlling interests		85	163	32
Attributable to members of South32		132	(1,467)	1,401
Basic earnings/(loss) per ordinary share (US cents)	8	2.48	(27.55)	26.31
Diluted earnings/(loss) per ordinary share (US cents)	8	2.47	(27.46)	26.20

The accompanying notes form part of the historical combined financial information.

Certain administrative costs, net finance costs, tax and pension amounts of South32 reflect the management and capital structure of South32 prior to the Demerger. Accordingly these amounts, together with respective earnings per share figures, may not be comparable with actual amounts that would have occurred had the Demerger been in effect during the periods presented. Refer to Section 1.6 ('Basis of preparation of historical combined financial information') for details of assumptions made in preparing the historical combined financial information.

1.2 COMBINED STATEMENT OF COMPREHENSIVE INCOME

	Notes	2014 US\$M	2013 US\$M	2012 US\$M
Profit/(loss) after taxation		217	(1,304)	1,433
Other comprehensive income				
Items that may be reclassified subsequently to the income statement:				
Available for sale investments:				
Net valuation losses taken to equity		(17)	(114)	(45)
Net valuation (gains)/losses transferred to the income statement		(4)	2	–
Tax recognised within other comprehensive income	7	3	17	(15)
Total items that may be reclassified subsequently to the income statement		(18)	(95)	(60)
Items that will not be reclassified to the income statement:				
Actuarial (losses)/gains on pension and medical schemes				
		(2)	2	(12)
Tax recognised within other comprehensive income	7	–	–	6
Total items that will not be reclassified to the income statement		(2)	2	(6)
Total other comprehensive loss		(20)	(93)	(66)
Total comprehensive income/(loss)		197	(1,397)	1,367
Attributable to non-controlling interests		85	164	34
Attributable to members of South32		112	(1,561)	1,333

The accompanying notes form part of the historical combined financial information.

1.3 COMBINED BALANCE SHEET

	Notes	2014 US\$M	2013 US\$M	2012 US\$M
ASSETS				
Current assets				
Cash and cash equivalents	20	353	345	346
Trade and other receivables	9	911	1,249	1,709
Receivables from BHP Billiton	9	1,943	1,809	3,553
Other financial assets	10	13	65	73
Inventories	11	1,427	1,550	1,723
Current tax assets		320	192	110
Other		35	26	30
Total current assets		5,002	5,236	7,544
Non-current assets				
Trade and other receivables	9	178	182	218
Other financial assets	10	502	539	732
Investments accounted for using the equity method		10	-	-
Inventories	11	58	77	87
Property, plant and equipment	12	12,616	12,101	14,462
Intangible assets	13	291	343	326
Deferred tax assets	7	1,013	1,041	613
Other		20	24	30
Total non-current assets		14,688	14,307	16,468
Total assets		19,690	19,543	24,012
LIABILITIES				
Current liabilities				
Trade and other payables	14	1,311	1,586	2,011
Payables to BHP Billiton	14	28	10	13
Interest bearing liabilities	15	47	93	204
Interest bearing liabilities payable to BHP Billiton	15	-	341	-
Other financial liabilities	16	4	-	43
Current tax payable		199	128	254
Provisions	17	537	593	616
Deferred income		7	13	53
Total current liabilities		2,133	2,764	3,194
Non-current liabilities				
Trade and other payables	14	56	8	19
Interest bearing liabilities	15	1,253	281	314
Interest bearing liabilities payable to BHP Billiton	15	3,728	4,000	4,071
Other financial liabilities	16	6	7	20
Deferred tax liabilities	7	523	580	547
Provisions	17	2,170	1,779	2,032
Deferred income		1	4	3
Total non-current liabilities		7,737	6,659	7,006
Total liabilities		9,870	9,423	10,200
Net assets		9,820	10,120	13,812
INVESTED CAPITAL				
Invested capital attributable to members of South32		8,953	9,213	13,010
Invested capital attributable to non-controlling interests		867	907	802
Total invested capital		9,820	10,120	13,812

The accompanying notes form part of the historical combined financial information.

1.4 COMBINED CASH FLOW STATEMENT

	Notes	2014 US\$M	2013 US\$M	2012 US\$M
Operating activities				
Profit/(loss) before taxation		422	(1,096)	2,018
Adjustments for:				
Depreciation and amortisation expense		985	964	905
Net (gain)/loss on sale of non-current assets		(22)	(29)	4
Impairments/(reversals) of property, plant and equipment, financial assets and intangibles		319	2,210	108
Net finance costs		352	133	42
Share of operating profit of equity accounted investments		(10)	–	–
Other		(15)	(38)	9
Changes in assets and liabilities:				
Trade and other receivables		111	265	492
Inventories		112	183	160
Trade and other payables		(142)	(266)	(523)
Net other financial assets and liabilities		41	30	(117)
Provisions and other liabilities		(45)	(218)	(199)
Cash generated from operations		2,108	2,138	2,899
Dividends received		31	17	23
Interest received		24	42	48
Interest paid		(175)	(74)	(35)
Income tax refunded		4	–	–
Income tax paid		(322)	(697)	(542)
Net operating cash flows		1,670	1,426	2,393
Investing activities				
Purchases of property, plant and equipment		(769)	(1,139)	(2,013)
Exploration expenditure		(24)	(29)	(51)
Exploration expenditure expensed and included in operating cash flows		17	21	41
Purchase of intangibles		–	(20)	–
Investment in financial assets		(24)	(21)	(8)
Cash outflows from investing activities		(800)	(1,188)	(2,031)
Proceeds from sale of property, plant and equipment		48	64	–
Proceeds from financial assets		52	19	8
Net investing cash flows		(700)	(1,105)	(2,023)
Financing activities				
Proceeds from interest bearing liabilities		251	2,274	74
Repayment of interest bearing liabilities		(456)	(112)	(366)
Proceeds from issue of shares		–	9	–
Other movements in invested capital		(116)	(107)	13
Dividends paid		(505)	(2,296)	(79)
Dividends paid to non-controlling interests		(133)	(59)	(56)
Net financing cash flows		(959)	(291)	(414)
Net increase/(decrease) in cash and cash equivalents		11	30	(44)
Cash and cash equivalents, net of overdrafts, at the beginning of the financial year		345	327	394
Foreign currency exchange rate changes on cash and cash equivalents		(3)	(12)	(23)
Cash and cash equivalents, net of overdrafts, at the end of the financial year	20	353	345	327

The accompanying notes form part of the historical combined financial information.

1.5 COMBINED STATEMENT OF CHANGES IN INVESTED CAPITAL

	2014 US\$M	2013 US\$M	2012 US\$M
Invested capital attributable to members of South32			
Balance as at 1 July	9,213	13,010	11,621
Profit/(loss) for the year	132	(1,467)	1,401
Other comprehensive income	(20)	(94)	(68)
Dividends paid	(505)	(2,296)	(79)
Equity transactions with BHP Billiton	133	60	135
Balance as at 30 June	8,953	9,213	13,010
Invested capital attributable to non-controlling interests			
Balance as at 1 July	907	802	824
Profit for the year attributable to non-controlling interests	85	163	32
Other comprehensive income	-	1	2
Distributions paid to non-controlling interests	(133)	(59)	(56)
Distribution to option holders	(2)	-	-
Equity contributed	10	-	-
Balance as at 30 June	867	907	802

The accompanying notes form part of the historical combined financial information.

1.6 NOTES TO THE HISTORICAL COMBINED FINANCIAL INFORMATION

1 Accounting policies

General information

South32 Limited, formerly BHP Coal Holdings Proprietary Limited, is a public limited liability company registered in Australia and is proposed to be listed with a primary listing on the ASX, a secondary listing on the JSE and all the South32 Shares will be admitted to the standard segment of the Official List and to trading on the LSE's main market for listed securities. The nature of the operations and principal activities of South32 and its subsidiaries and interests in joint operations ("South32") are set out in Section 7.

The "Basis of preparation of historical combined financial information" section describes how the historical combined financial information has been prepared in accordance with:

- Australian Accounting Standards, being Australian equivalents to International Financial Reporting Standards and interpretations as issued by the Australian Accounting Standards Board (collectively, AASBs);
- International Financial Reporting Standards and interpretations as adopted by the European Union (EU); and
- International Financial Reporting Standards and interpretations as issued by the International Accounting Standards Board.

The above accounting standards and interpretations are collectively referred to as 'IFRS'.

Instances where a departure has occurred from these financial reporting standards have been described in the "Basis of preparation of historical combined financial information" section below. The directors are responsible for the preparation of the historical combined financial information and believe that the basis of preparation fairly presents South32's historical financial information in the circumstances set out below.

The historical combined financial information is prepared in accordance with the requirements of the SAICA Financial Reporting Guides as issued by the Accounting Practices Committee and Financial Reporting Pronouncements as issued by the Financial Reporting Standards Council.

Basis of preparation of historical combined financial information

The historical combined financial information has been prepared in accordance with the requirements of Sections 8.1 to 8.13 of the JSE Listing Requirements and the applicable UKLA Listing Rules and Prospectus Directive and in accordance with this basis of preparation. The basis of preparation describes how the financial information has been prepared in accordance with IFRS, except as described below.

IFRS do not provide for the preparation of historical combined financial information, and accordingly in preparing the historical combined financial information certain accounting conventions commonly used for the preparation of historical combined financial information for inclusion in investment circulars as described in the Annexure to SIR 2000 (Investment Reporting Standards applicable to public reporting engagements on historical financial information) issued by the UK Auditing Practices Board have been applied. The application of these conventions results in the following material departures from IFRS. In all other respects IFRS has been applied.

Historical combined financial information

South32 has not in the past constituted a separate legal group. The historical combined financial information for the years ended 30 June 2014, 2013 and 2012 and the half years ended 31 December 2014 and 2013 (the "Reporting Period") have been prepared by aggregating historical financial information relating to the businesses that will be held by South32 at the date of Demerger including assets, liabilities and transactions directly attributable to South32. This historical combined financial information has previously been reported as part of the annual consolidated financial statements of BHP Billiton for the Reporting Period, and BHP Billiton's financial statements were prepared in accordance with IFRS and AASBs. All references to subsidiaries or joint operations include entities that will transfer to South32 at the date of Demerger.

The historical combined financial information has been prepared with the objective of presenting the results, net assets and cash flows of South32 for the periods identified. The entities which comprise South32 have been under common management and control of BHP Billiton throughout the periods presented in the historical combined financial information. Consequently, this historical combined financial information may not necessarily be indicative of the financial performance that would have been achieved if South32 had operated as an independent entity for the Reporting Period, nor may it be indicative of the results of operations of South32 for any future period.

The historical combined financial information combines only the financial information for those businesses that will be part of South32 at the date of the Demerger. The principal subsidiaries and interests in joint operations included within the historical combined financial information are shown in note 21 Subsidiaries and note 22 Interests in joint operations.

All trading balances between South32 Businesses and BHP Billiton which have historically been eliminated in the consolidated financial statements of BHP Billiton have now been presented as either receivable, payables or interest bearing liabilities as though they were with an external related party. These transactions and balances are presented in note 24 Related party balances and transactions.

Transactions and balances between South32 Businesses included within the historical combined financial information have been eliminated, consistent with the principles of IFRS 10 'Consolidated Financial Statements'.

Share capital and reserves

As South32 has not in the past formed a separate legal group, and there will be a significant change in the composition of total equity (i.e. share capital and reserves) on Demerger, it is not meaningful to disclose historical share capital balances or an analysis of historical reserve balances. The total equity attributable to members of South32 as disclosed in the historical combined financial information represents the cumulative investment of BHP Billiton in the South32 Group Businesses (shown as “invested capital”). South32’s investments in BHP Billiton entities, which do not form part of South32 after the Demerger, have been deducted from invested capital. Where South32’s interest is less than 100 per cent, the interest attributable to outside shareholders is reflected in non-controlling interests.

Earnings per share, diluted earnings per share and headline earnings per share

Information on earnings per share as required to be presented under IAS 33 ‘Earnings per Share’ has been calculated for South32 and its subsidiary group based on an assumed capital structure (number of shares) at the date of admission and applied historically. Consequently, the calculation is not in accordance with IAS 33, which requires the use of the weighted average number of ordinary shares of the South32 parent entity outstanding during the period.

The number of ordinary shares outstanding used to calculate earnings per share and headline earnings per share is based on the number of outstanding shares of BHP Billiton at the date of Demerger applied historically. Given the expected capital structure of South32 subsequent to the Demerger, and the fact that shares in South32 will be issued to BHP Billiton shareholders on a one for one basis, this is considered to be the most appropriate denominator on which to compute earnings per share for South32.

Information on Headline Earnings per Share as required by the JSE has been calculated for South32 in accordance with Circular 2/2013 as issued by The South African Institute of Chartered Accountants based on an assumed capital structure at the date of admission and applied historically (as described above). A reconciliation between basic and headline earnings is contained within note 8 Earnings, dividends and asset information per share.

Key management personnel (“KMP”)

Throughout the Reporting Period, those persons having the authority and responsibility for planning, directing and controlling the activities of South32 were represented by BHP Billiton’s KMP as South32’s operations and activities were managed as part of BHP Billiton. For this reason it is not relevant to disclose historical financial information relating to those individuals who will be the KMP of South32 post Demerger. With the exception of KMP disclosures, the disclosures made in note 24 Related party balances and transactions are consistent with the disclosures required by IAS 24 ‘Related Party Disclosures’ and are also consistent with the treatment adopted in the historical financial information of BHP Billiton.

Employee share ownership plan (“ESOP”)

South32 has not historically existed as a standalone group of legal entities and as such, no share ownership plans existed over South32’s securities. Amounts have been included in note 5 Expenses in this historical combined financial information reflective of amounts previously charged by BHP Billiton to South32 companies for employees which formed part of the BHP Billiton ESOP. The disclosures relating to BHP Billiton’s share ownership plans is set out in the BHP Billiton financial statements.

Australian specific disclosures

AASB 1054 ‘Australian Additional Disclosures’ includes additional disclosure requirements which are not needed for IFRS compliance. For the purpose of this historical combined financial information, these additional disclosures have been omitted.

Other principles applied

In addition, the following principles have been applied in preparing the historical combined financial information:

- Throughout the Reporting Period, BHP Billiton has incurred costs within its central functions in Melbourne, London and Singapore. A portion of these costs has been deducted from the underlying trading results of the South32 Businesses in arriving at the results for South32 as a whole. These centrally incurred costs, and their treatment in the historical combined financial information, can be analysed as follows:
 - “Unallocated central costs”: headquarter costs (for example company secretarial costs) relating to BHP Billiton’s operations as a public company. These costs have not been allocated to the South32 Group Businesses as any allocation would have been arbitrary in nature.
 - “Allocated central costs”: headquarter costs (for example information technology, tax and treasury functions) which relate to the management and oversight of the South32 Businesses. These costs have been allocated to the businesses on the basis of:
 - Project based allocation (such as time spent/project spend); or
 - Non project based allocation (such as head count/transaction volumes).

In preparing the historical combined financial information, “unallocated central costs” relating to BHP Billiton’s central headquarters have been excluded from the historical combined financial information for South32. This is because any allocation would be arbitrary in nature and may not reflect properly the headquarter costs as would have been incurred by South32 had it been a standalone business throughout the Reporting Period. The historical combined financial information for South32 reflects the

“allocated central costs” relating to BHP Billiton’s central headquarters as these costs were historically allocated against and charged to the South32 Businesses and therefore form part of the historical combined financial information for South32.

As a result of the above treatment, financial information for the Reporting Period relating to the remuneration of the South32 Directors excludes the remuneration of those South32 Directors who were also directors of BHP Billiton and whose remuneration cost is included in the unallocated central corporate costs of BHP Billiton.

- BHP Billiton operates a centrally managed treasury function responsible for the provision of funding to operating businesses in conjunction with monitoring and maintaining BHP Billiton’s cash balances. Cash is collected through cash accounts held by BHP Billiton or on their behalf through cash accounts managed by BHP Billiton. Net interest arising on the total cash balances held by BHP Billiton, including cash accounts held by South32 entities, is paid to or payable on a net basis from a BHP Billiton cash account. Therefore the net finance cost included in the historical combined financial statements may not necessarily represent what the net financing costs would have been, if South32 had historically obtained financing and managed its cash on a standalone basis.

All intra-group funding is provided under executed agreements between counterparties at arms-length interest rates with the corresponding interest income and expense reflected within the historical combined financial information of South32. Although the net finance costs (as historically incurred by the South32 Businesses) have been included in the historical combined financial information, these net financing costs may not be comparable with actual amounts which may have occurred had the Demerger been in effect during the Reporting Period and had South32 sourced its own funding under its own credit rating.

- Dividends paid or payable from South32 to BHP Billiton are reported in the historical combined financial information for the Reporting Period as belonging entirely to BHP Billiton, with no dividends reported as paid or payable to the future owners of the South32 parent entity. Accordingly, the historical record of dividend payments may not be comparable with amounts which may have occurred had the Demerger been in effect during the Reporting Period. The Demerger also gives rise to dividend payments and receipts between South32 Businesses and BHP Billiton (‘related party dividends’) which were previously eliminated upon the consolidation of BHP Billiton and which will not occur after the date of the Demerger.
- Awards were made to BHP Billiton employees (who will become employees of South32 post Demerger) under BHP Billiton’s Long Term Incentive Plan (LTIP), Group Incentive Scheme (GIS), Management Award Plan (MAP) and/or Group Short Term Incentive Plan (GSTIP). Awards were also made to employees under Shareplus, an all employee share purchase plan. These employee awards were offered in the underlying shares of BHP Billiton and as such there are no employee share ownership plans in South32. For the purpose of this combined financial information, transfers of BHP Billiton’s equity instruments to employees of South32 have been reflected as equity settled share-based payment transactions in the income statement.
- The policies for managing the financial risks to which South32’s activities were exposed, including the market risk resulting from fluctuations in commodity prices, exchange rates and interest rates; and liquidity risk, being the risk that South32 had insufficient debt facilities to finance its operational cash flow requirements and any maturing financial liabilities, were historically managed by BHP Billiton. In managing these risks, where appropriate, BHP Billiton used derivative financial instruments, including forward foreign exchange contracts, interest rate swaps and swaptions to manage the financial risks of South32. These derivative financial instruments were generally transacted by BHP Billiton’s central treasury and risk management departments and were not allocated to or did not form part of the historical financial information of the South32 Businesses. Accordingly, the only derivative activity reported in the historical combined financial information relates to forward commodity and other derivative contract exposures entered into directly by South32 Businesses. Details of the risk mitigation policies as implemented by BHP Billiton are further highlighted in note 23 Financial risk management.
- Provisions included in the historical combined financial information for employee benefits (including on costs, superannuation, pensions and other post-retirement obligations) and closure and rehabilitation obligations relate to the South32 Businesses and excludes any amounts which represent unallocated central costs. The pension and post-retirement schemes included defined contribution pension schemes, multi-employer pension schemes, defined benefit pension schemes and the defined benefit post-retirement medical schemes. These schemes provide benefits to current and past employees and therefore represent obligations of both South32 and BHP Billiton.

At or prior to Demerger, the assets, liabilities and period costs of the schemes relating to the South32 Group Businesses will be transferred to South32 and are consequently included within the historical combined financial information. This does not include an apportionment of schemes for employees included within central costs. Detailed disclosures relating to these schemes are provided in note 25 Pensions and other post retirement obligations.

- Tax charges in the historical combined financial information have been determined based on the tax charges recorded by South32 Businesses in their underlying ledgers. The tax charges recorded in the income statement included in the historical combined financial information have been affected by the tax arrangements within BHP Billiton and are not necessarily representative of the tax charges that would have been reported had South32 been an independent group throughout the Reporting Period.

- Deferred tax assets recognised within the historical combined financial information have been recognised based on assessments of their recoverability whilst operating as part of the BHP Billiton Group. These deferred tax assets may not be fully reflective of balances that would have been recognised had South32 been operating independently during the Reporting Period.
- Items identified as Significant and requiring individual disclosure are those items where their nature and amount is considered material to the financial information of South32. Additional details of significant items impacting South32's results for the Reporting Period can be found in note 3 Significant items.
- Goodwill in South32 arose where the fair value of consideration paid for a business combination exceeded the fair value of South32's share of the identifiable net assets acquired. The goodwill balances have been attributed to the cash-generating units of the South32 Businesses consistent with the historical treatment of these balances within BHP Billiton.

In preparing the historical combined financial information for the Reporting Period, the following accounting standards or interpretations have been adopted for each period such that the financial impact of adopting each individual standard or interpretation has not been separately disclosed. Each of these standards and interpretations has been adopted by BHP Billiton in the preparation of its financial statements:

- IFRS 10/AASB 10 'Consolidated Financial Statements' which is a replacement of IAS 27 'Consolidated and Separate Financial Statements';
- IFRS 11 'Joint Arrangements' which is a replacement of IAS 31 'Joint Ventures';
- IFRIC 20 'Stripping Costs in the Production Phase of a Surface Mine';
- IFRS 13 'Fair Value Measurement' (as issued at 1 January 2013); and
- Amendments to IAS 19 'Employee Benefits'.

In addition, South32 has early-adopted amendments to IAS 36 'Impairment of Assets'. South32 has also changed its Exploration and Evaluation Expenditure policy from 1 July 2013 such that all acquisitions of exploration leases are classified as intangible exploration assets or tangible exploration assets based on the nature of the assets acquired.

Basis of measurement

The financial information is drawn up on the basis of historical cost principles, except for certain financial assets, which are carried at fair value.

Rounding of amounts

Amounts in the historical combined financial information have, unless otherwise indicated, been rounded to the nearest million dollars.

Currency of presentation

All amounts are expressed in millions of US dollars, unless otherwise stated, consistent with the functional currency of South32's operations.

Consistent application of accounting policies

The accounting policies applied are, except noted above in the "Basis of preparation of historical combined financial information" section, consistent with those applied in the BHP Billiton financial statements and have been consistently applied by all entities included in the South32 historical combined financial information for all periods presented.

Comparatives

Where applicable, comparatives have been adjusted to measure or present them on the same basis as current period figures.

Principles of consolidation

Except as noted above in the "Basis of preparation of historical combined financial information" section, the financial information of South32 includes the consolidation of the respective subsidiaries of South32. Subsidiaries are included in the historical combined financial information from the date control commences until the date control ceases. Where South32's interest is less than 100 per cent, the interest attributable to outside shareholders is reflected in non-controlling interests. The effects of all transactions between entities within South32 have been eliminated.

Joint arrangements

South32 undertakes a number of business activities through joint arrangements. Joint arrangements exist when two or more parties have joint control. Joint control is the contractually agreed sharing of control of an arrangement, which exists only when decisions about the relevant activities require the unanimous consent of the parties sharing control. South32's joint arrangements are of two types:

Joint operations

Joint operations are joint arrangements in which the parties with joint control have rights to the assets and obligations for the liabilities relating to the arrangement. The activities of a joint operation are primarily designed for the provision of output to the parties to the arrangement, indicating that:

- the parties have the rights to substantially all the economic benefits of the assets of the arrangement; and
- all liabilities are satisfied by the joint participants through their purchases of that output. This indicates that, in substance, the joint participants have an obligation for the liabilities of the arrangement.

The financial information of South32 include its share of the assets in joint operations, together with its share of the liabilities, revenues and expenses arising jointly or otherwise from those operations and its revenue derived from the sale of its share of output from the joint operation. All such amounts are measured in accordance with the terms of each arrangement, which are usually in proportion to South32's interest in the joint operation.

Joint ventures

Joint ventures are joint arrangements in which the parties with joint control of the arrangement have rights to the net assets of the arrangement. A separate vehicle, not the parties, will have the rights to the assets and obligations to the liabilities, relating to the arrangement. More than an insignificant share of output from a joint venture is sold to third parties which indicates that the joint venture is not dependent on the parties to the arrangement for funding and that the parties to the arrangement have no obligation for the liabilities of the arrangement.

Joint ventures are accounted for using the equity method. Under the equity method the joint venture is recorded initially at cost to South32, including the value of any goodwill on acquisition. In subsequent periods, the carrying amount of the joint venture is adjusted to reflect South32's share of its post-acquisition profit or loss and other comprehensive income. After application of the equity method, including recognising South32's share of the joint ventures' results, the value of the investment will be assessed for impairment if there is objective evidence that an impairment of the investment may have occurred. Where South32's investment in a joint venture is nil after having applied equity accounting principles (and South32 has no legal or constructive obligation to make further payments, nor has made payments on behalf of the joint venture), dividends received from the joint venture will be recognised in South32's results as a 'Share of operating profit of equity accounted investments'.

Associates

Associates are entities in which South32 holds significant influence. Significant influence is the power to participate in the financial and operating policy decisions of an entity but is not control or joint control. If South32 holds 20 per cent or more of the voting power of an entity, it is presumed that South32 has significant influence, unless it can be clearly demonstrated that this is not the case. Significant influence can also arise when South32 has less than 20 per cent of voting power but it can be demonstrated that South32 has the power to participate in the financial and operating policy decisions of the associate.

Investments in associates are accounted for using the equity method as described above. South32 uses the term 'equity accounted investments' to refer to associates and joint ventures collectively.

Business combinations

Business combinations, other than restructures within the BHP Billiton Group that occurred between 1 July 2004 and 30 June 2009, were accounted for by applying the purchase method of accounting, whereby the purchase consideration of the combination is allocated to the identifiable net assets acquired. Business combinations prior to 1 July 2004 have been accounted for in accordance with South32's previous policies operating as part of BHP Billiton under Australian generally accepted accounting principles ("GAAP") and UK GAAP and have not been restated.

Business combinations undertaken from 1 July 2010 are accounted for by applying the acquisition method of accounting, whereby the identifiable assets, liabilities and contingent liabilities (identifiable net assets) are measured on the basis of fair value at the date of acquisition.

Goodwill

Where the fair value of consideration paid for a business combination exceeds the fair value of South32's share of the identifiable net assets acquired, the difference is treated as purchased goodwill. Where the fair value of South32's share of the identifiable net assets acquired exceeds the cost of acquisition, the difference is immediately recognised in the income statement. The recognition and measurement of goodwill attributable to a non-controlling interest in a business combination is determined on a transaction by transaction basis. Goodwill is not amortised, however its carrying amount is assessed annually against its recoverable amount as explained below under 'Impairment of non-current assets'. On the subsequent disposal or termination of a previously acquired business, any remaining balance of associated goodwill is included in the determination of the profit or loss on disposal or termination.

Intangible assets

Amounts paid for the acquisition of identifiable intangible assets, such as software and licences, are capitalised at the fair value of consideration paid and are recorded at cost less accumulated amortisation and impairment charges. Identifiable intangible assets with a finite life are amortised on a straight-line basis over their expected useful life, which is typically no greater than eight years. South32 has no identifiable intangible assets for which the expected useful life is indefinite.

Foreign currencies

South32's reporting currency and the functional currency of its operations is the US dollar as this is assessed to be the principal currency of the economic environments in which it operates.

Transactions denominated in foreign currencies (currencies other than the functional currency of an operation) are recorded using the exchange rate ruling at the date of the underlying transaction. Monetary assets and liabilities denominated in foreign currencies are translated using the rate of exchange prevailing at year-end and the gains or losses on retranslation are included in the income statement, with the exception of foreign exchange gains or losses on foreign currency provisions for site closure and rehabilitation, which are capitalised in property, plant and equipment for operating sites.

Share-based payments

South32 has historically been charged by BHP Billiton for share awards granted to employees in the South32 Group. The fair value at grant date of equity-settled share awards is charged to the income statement over the period for which the benefits of employee services are expected to be derived. The fair value of awards is calculated using an option pricing model which considers the following factors:

- exercise price;
- expected life of the award;
- current market price of the underlying shares;
- expected volatility;
- expected dividends;
- risk-free interest rate;
- market-based performance hurdles;
- non-vesting conditions.

Sales revenue

Revenue from the sale of goods and disposal of other assets is recognised when persuasive evidence (usually in the form of an executed sales agreement) of an arrangement exists and:

- there has been a transfer of risks and rewards to the customer;
- no further work or processing is required by South32;
- the quantity and quality of the goods has been determined with reasonable accuracy;
- the price is fixed or determinable;
- collectability is reasonably assured.

Revenue is therefore generally recognised when title passes. In the majority of sales for most commodities, sales agreements specify that title passes on the bill of lading date, which is the date the commodity is delivered to the shipping agent. For these sales, revenue is recognised on the bill of lading date. For certain sales (principally coal sales to adjoining power stations and diamond sales), title passes and revenue is recognised when the goods have been delivered.

In cases where the terms of the executed sales agreement allow for an adjustment to the sales price based on a survey of the goods by the customer (for instance an assay for mineral content), recognition of the sales revenue is based on the most recently determined estimate of product specifications.

For certain commodities, the sales price is determined on a provisional basis at the date of sale and adjustments to the sales price subsequently occurs based on movements in quoted market or contractual prices up to the date of final pricing. The period between provisional invoicing and final pricing is typically between 60 and 120 days. Revenue on provisionally priced sales is recognised based on the estimated fair value of the total consideration receivable. The revenue adjustment mechanism embedded within provisionally priced sales arrangements has the character of a commodity derivative. Accordingly, the fair value of the final sales price adjustment is re-estimated continuously and changes in fair value are recognised as an adjustment to revenue. In all cases, fair value is estimated by reference to forward market prices.

Revenue is not reduced for royalties and other taxes payable from South32's production.

South32 separately discloses sales of Group production from sales of third party products because of the significant difference in profit margin earned on these sales.

Exploration and evaluation expenditure

Exploration and evaluation activity involves the search for mineral resources, the determination of technical feasibility and the assessment of commercial viability of an identified resource. Exploration and evaluation activity includes:

- researching and analysing historical exploration data;
- gathering exploration data through topographical, geochemical and geophysical studies;
- exploratory drilling, trenching and sampling;
- determining and examining the volume and grade of the resource;
- surveying transportation and infrastructure requirements;
- conducting market and finance studies.

Administration costs that are not directly attributable to a specific exploration area are charged to the income statement. Initial payments for the acquisition of intangible lease assets are capitalised and amortised over the term of the permit.

Exploration and evaluation expenditure (including amortisation of capitalised licence and lease costs) is charged to the income statement as incurred except in the following circumstances, in which case the expenditure may be capitalised:

- The exploration and evaluation activity is within an area of interest which was previously acquired as an asset acquisition or in a business combination and measured at fair value on acquisition; or
- The existence of a commercially viable mineral deposit has been established.

Capitalised exploration and evaluation expenditure considered to be a tangible asset is recorded as a component of property, plant and equipment at cost less impairment charges. Otherwise, it is recorded as an intangible asset (such as certain licence and lease arrangements). In determining whether the purchase of an exploration licence or lease is an intangible asset or a component of property, plant and equipment, consideration is given to the substance of the item acquired not its legal form. Licences or leases purchased which allow exploration over an extended period of time meet the definition of an intangible exploration lease asset where they cannot be reasonably associated with a known minerals resource. All capitalised exploration and evaluation expenditure is monitored for indications of impairment. When a potential impairment is indicated, assessment is performed for each area of interest in conjunction with South32 of operating assets (representing a cash-generating unit) to which the exploration is attributed. To the extent that capitalised expenditure is no longer expected to be recovered, it is charged to the income statement.

Development expenditure

When proved resources are determined and development is sanctioned, capitalised exploration and evaluation expenditure is reclassified as assets under construction, and is disclosed as a component of property, plant and equipment. All subsequent development expenditure is capitalised and classified as assets under construction, provided commercial viability conditions continue to be satisfied. Development expenditure is net of proceeds from the sale of ore extracted during the development phase. On completion of development, all assets included in assets under construction are reclassified as either plant and equipment or other mineral assets.

Property, plant and equipment

Property, plant and equipment is recorded at cost less accumulated depreciation and impairment charges. Cost is the fair value of consideration given to acquire the asset at the time of its acquisition or construction and includes the direct cost of bringing the asset to the location and condition necessary for operation and the estimated future cost of closure and rehabilitation of the facility.

Other mineral assets

Other mineral assets comprise:

- capitalised exploration, evaluation and development expenditure (including development stripping) for properties now in production;
- mineral rights acquired;
- capitalised production stripping (as described below in 'Overburden removal costs').

Depreciation of property, plant and equipment

The carrying amounts of property, plant and equipment are depreciated to their estimated residual value over the estimated useful lives of the specific assets concerned, or the estimated life of the associated mine, field or lease, if shorter. Estimates of residual values and useful lives are reassessed annually and any change in estimate is taken into account in the determination of remaining depreciation charges. Depreciation commences on the date of commissioning. The major categories of property, plant and equipment are depreciated on a unit of production and/or straight-line basis using estimated lives indicated below. However, where assets are dedicated to a mine, field or lease and are not readily transferable, the below useful lives are subject to the lesser of the asset category's useful life and the life of the mine, field or lease:

Buildings	25 to 50 years
Land	not depreciated
Plant and equipment	3 to 30 years straight-line
Mineral rights	based on reserves on a unit of production basis
Capitalised exploration, evaluation and development expenditure	based on reserves on a unit of production basis

Leased assets

Assets held under lease, which result in South32 receiving substantially all the risks and rewards of ownership of the asset (finance leases), are capitalised at the lower of the fair value of the property, plant and equipment or the estimated present value of the minimum lease payments.

The corresponding finance lease obligation is included within interest bearing liabilities. The interest component is charged to financial expenses over the lease term to reflect a constant rate of interest on the remaining balance of the obligation.

Operating lease assets are not capitalised and rental payments are included in the income statement on a straight-line basis over the lease term. Provision is made for the present value of future operating lease payments in relation to surplus lease space, when it is first determined that the space will be of no probable future benefit. Operating lease incentives are recognised as a liability when received and subsequently reduced by allocating lease payments between rental expense and reduction of the liability.

Impairment and reversal of impairment of non-current assets

Formal impairment tests are carried out annually for goodwill. In addition, formal impairment tests for all assets are performed when there is an indication of impairment. South32 conducts an internal review of asset values annually, which is used as a source of information to assess for any indications of impairment or reversal of previously recognised impairment losses. External factors, such as changes in expected future prices, costs and other market factors are also monitored to assess for indications of impairment or reversal of previously recognised impairment losses. If any such indication exists, an estimate of the asset's recoverable amount is calculated, being the higher of fair value less direct costs of disposal and the asset's value in use.

If the carrying amount of the asset exceeds its recoverable amount, the asset is impaired and an impairment loss is charged to the income statement so as to reduce the carrying amount in the balance sheet to its recoverable amount. A reversal of a previously recognised impairment loss is limited to the lesser of the amount that would not cause the carrying amount to exceed (a) its recoverable amount; or (b) the carrying amount that would have been determined (net of depreciation) had no impairment loss been recognised for the asset or cash-generating unit.

Fair value is determined as the amount that would be obtained from the sale of the asset in an orderly transaction between market participants. Fair value for mineral assets is generally determined as the present value of the estimated future cash flows expected to arise from the continued use of the asset, including any expansion prospects, and its eventual disposal, using assumptions that an independent market participant may take into account. These cash flows are discounted at an appropriate rate to arrive at a net present value of the asset.

Value in use is determined as the present value of the estimated future cash flows expected to arise from the continued use of the asset in its present form and its eventual disposal. Value in use is determined by applying assumptions specific to South32's continued use and cannot take into account future development. These assumptions are different to those used in calculating fair value and consequently the value in use calculation is likely to give a different result (usually lower) to a fair value calculation.

In testing for indications of impairment and performing impairment calculations, assets are considered as collective groups and referred to as cash-generating units. Cash-generating units are the smallest identifiable group of assets, liabilities and associated goodwill that generate cash inflows that are largely independent of the cash inflows from other assets or groups of assets.

The impairment assessments are based on a range of estimates and assumptions, including:

Estimates/assumptions:	Basis:
Future production	proved and probable reserves, resource estimates and, in certain cases, expansion projects
Commodity prices	forward market and contract prices, and longer-term price protocol estimates
Exchange rates	current (forward) market exchange rates
Discount rates	cost of capital risk-adjusted appropriate to the resource

Overburden removal costs

The process of removing overburden and other mine waste materials to access mineral deposits is referred to as stripping. In open-pit mining, stripping costs are accounted for separately for each component of an ore body. A component is a specific section within an ore body that is made more accessible by the stripping activity. The identification of components is dependent on the mine plan and will often comprise a separate pushback or phase identified in the plan.

There are two types of stripping activity:

- Development stripping is the initial overburden removal during the development phase to obtain access to a mineral deposit that will be commercially produced.
- Production stripping is the interburden removal during the normal course of production activity. Production stripping commences after the first saleable minerals have been extracted from the component.

Development stripping costs are capitalised as a development stripping asset when:

- It is probable that future economic benefits associated with the asset will flow to the entity; and
- The costs can be measured reliably.

Production stripping can give rise to two benefits, being the extraction of ore in the current period and improved access to the ore body component in future periods. To the extent that the benefit is the extraction of ore the stripping costs are recognised as an inventory cost. To the extent the benefit is improved access to future ore, the stripping costs are recognised as a production stripping asset if the following criteria are met:

- It is probable that the future economic benefit (improved access to ore) will flow to the entity;
- The component of the ore body for which access has been improved can be identified; and
- The costs relating to the stripping activity can be measured reliably.

Production stripping costs are allocated between the inventory produced and the production stripping asset using a life-of-component waste to ore (or mineral contained) strip ratio. When the current strip ratio is greater than the life-of-component ratio a portion of the stripping costs is capitalised to the production stripping asset.

The development and production stripping assets are depreciated on a units of production basis based on the proven and probable reserves of the relevant components. Stripping assets are classified as other mineral assets in property, plant and equipment.

Inventories

Inventories, including work in progress, are valued at the lower of cost and net realisable value. Cost is determined primarily on the basis of average costs. For processed inventories, cost is derived on an absorption costing basis. Cost comprises cost of purchasing raw materials and cost of production, including attributable mining and manufacturing overheads. In respect of minerals inventory, quantities are assessed primarily through surveys and assays.

Finance costs

Finance costs are expensed as incurred except where they relate to the financing of construction or development of qualifying assets requiring a substantial period of time to prepare for their intended future use, in which case finance costs are capitalised up to the date when the asset is ready for its intended use. The amount of finance costs capitalised (before the effects of income tax) for the period is determined by applying the interest rate applicable to appropriate borrowings outstanding during the period, to the average amount of capitalised expenditure for the qualifying assets during the period.

Taxation

Taxation on the profit or loss for the year comprises current and deferred tax. Taxation is recognised in the income statement except to the extent that it relates to items recognised directly in equity, in which case the tax is recognised in equity.

Current tax is the expected tax payable on the taxable income for the year using rates enacted or substantively enacted at period end, and includes any adjustment to tax payable in respect of previous years.

Deferred tax is provided using the balance sheet liability method, providing for the tax effect of temporary differences between the carrying amount of assets and liabilities for financial reporting purposes and the amounts used for tax assessment or deduction purposes. Where an asset has no deductible or depreciable amount for income tax purposes, but has a deductible amount on sale or abandonment for capital gains tax purposes, that amount is included in the determination of temporary differences. The tax effect of certain temporary differences is not recognised, principally with respect to: goodwill; temporary differences arising on the initial recognition of assets or liabilities (other than those arising in a business combination or in a manner that initially impacted accounting or taxable profit); and temporary differences relating to investments in subsidiaries, joint ventures and associates to the extent that South32 is able to control the reversal of the temporary difference and it is probable that the temporary difference will not reverse in the foreseeable future. The amount of deferred tax recognised is based on the expected manner and timing of realisation or settlement of the carrying amount of assets and liabilities, with the exception of items that have a tax base solely derived under capital gains tax legislation, using tax rates enacted or substantively enacted at period end. To the extent that an item's tax base is solely derived from the amount deductible under capital gains tax legislation, deferred tax is determined as if such amounts are deductible in determining future assessable income.

A deferred tax asset is recognised only to the extent that it is probable that future taxable profits will be available against which the asset can be utilised. Deferred tax assets are reviewed at each balance sheet date and amended to the extent that it is no longer probable that the related tax benefit will be realised. Deferred tax assets and liabilities are offset when they relate to income taxes levied by the same taxation authority and South32 has both the right and the intention to settle its current tax assets and liabilities on a net or simultaneous basis.

Royalties and resource rent taxes are treated as taxation arrangements when they have the characteristics of a tax. This is considered to be the case when they are imposed under government authority and the amount payable is calculated by reference to revenue derived (net of any allowable deductions) after adjustment for temporary differences. For such arrangements, current and deferred tax is provided on the same basis as described above for other forms of taxation. Obligations arising from royalty arrangements that do not satisfy these criteria are recognised as current provisions and included in expenses.

Provision for employee benefits

Provision is made in the financial information for all employee benefits, including on costs. In relation to industry-based long service leave funds, South32's liability, including obligations for funding shortfalls, is determined after deducting the fair value of dedicated assets of such funds.

Liabilities for unpaid wages and salaries are recognised in sundry creditors. Current entitlements to annual leave and accumulating sick leave accrued for services up to the reporting date are recognised in provision for employee benefits and are measured at the amounts expected to be paid. Entitlements to non-accumulating sick leave are recognised when the leave is taken.

The current liability for long service leave (for which settlement within 12 months of the reporting date cannot be deferred) is recognised in the current provision for employee benefits and is measured in accordance with annual leave described above. The non-current liability for long service leave is recognised in the non-current provision for employee benefits and measured as the present value of expected future payments to be made in respect of services provided by employees up to the reporting date. Consideration is given to expected future wage and salary levels, experience of employee departures and periods of service. Expected future payments are discounted using market yields at the reporting date on national government bonds with terms to maturity and currency that match, as closely as possible, the estimated future cash outflows.

Superannuation, pensions and other post-retirement benefits

South32 operates or participates in a number of pension (including superannuation) schemes throughout the world. The funding of the schemes complies with local regulations. The assets of the schemes are generally held separately from those of South32 and are administered by trustees or management boards.

For defined contribution schemes or schemes operated on an industry-wide basis where it is not possible to identify assets attributable to the participation by South32's employees, the pension charge is calculated on the basis of contributions payable.

For defined benefit schemes, the cost of providing pensions is charged to the income statement so as to recognise current and past service costs, interest cost on defined benefit obligations, and the effect of any curtailments or settlements, net of expected returns on plan assets. Actuarial gains and losses are recognised directly in equity. An asset or liability is consequently recognised in the balance sheet based on the present value of defined benefit obligations, less any unrecognised past service costs and the fair value of plan assets, except that any such asset cannot exceed the present value of expected refunds from and reductions in future contributions to the plan. Defined benefit obligations are estimated by discounting expected future payments using market yields at the reporting date on high-quality corporate bonds in countries that have developed corporate bond markets. However, where developed corporate bond markets do not exist, the discount rates are selected by reference to national government bonds. In both instances, the bonds are selected with terms to maturity and currency that match, as closely as possible, the estimated future cash flows.

Certain South32 companies provide post-retirement medical benefits to qualifying retirees. In some cases the benefits are provided through medical care schemes to which South32, the employees, the retirees and covered family members contribute. In some schemes there is no funding of the benefits before retirement. These schemes are recognised on the same basis as described above for defined benefit pension schemes.

Closure and rehabilitation

The mining, extraction and processing activities of South32 normally give rise to obligations for site closure or rehabilitation. Closure and rehabilitation works can include facility decommissioning and dismantling; removal or treatment of waste materials; site and land rehabilitation. The extent of work required and the associated costs are dependent on the requirements of relevant authorities and South32's environmental policies.

Provisions for the cost of each closure and rehabilitation program are recognised at the time that environmental disturbance occurs. When the extent of disturbance increases over the life of an operation, the provision is increased accordingly. Costs included in the provision encompass all closure and rehabilitation activity expected to occur progressively over the life of the operation and at or after the time of closure, for disturbance existing at the reporting date. Routine operating costs that may impact the ultimate closure and rehabilitation activities, such as waste material handling conducted as an integral part of a mining or production process, are not included in the provision. Costs arising from unforeseen circumstances, such as the contamination caused by unplanned discharges, are recognised as an expense and liability when the event gives rise to an obligation which is probable and capable of reliable estimation.

The timing of the actual closure and rehabilitation expenditure is dependent upon a number of factors such as the life and nature of the asset, the operating licence conditions, the principles of the BHP Billiton Charter and the environment in which the mine operates. Expenditure may occur before and after closure and can continue for an extended period of time dependent on closure and rehabilitation requirements. The majority of the expenditure is expected to be paid over periods of up to 50 years with some payments into perpetuity.

Closure and rehabilitation provisions are measured at the expected value of future cash flows, discounted to their present value and determined according to the probability of alternative estimates of cash flows occurring for each operation. Discount rates used are specific to the country in which the operation is located. Significant judgements and estimates are involved in forming expectations of future activities and the amount and timing of the associated cash flows. Those expectations are formed based on existing environmental and regulatory requirements or, if more stringent, South32 environmental policies which give rise to a constructive obligation.

When provisions for closure and rehabilitation are initially recognised, the corresponding cost is capitalised as an asset, representing part of the cost of acquiring the future economic benefits of the operation. The capitalised cost of closure and rehabilitation activities is recognised in property, plant and equipment and depreciated accordingly. The value of the provision is progressively increased over time as the effect of discounting unwinds, creating an expense recognised in financial expenses.

Closure and rehabilitation provisions are also adjusted for changes in estimates. Those adjustments are accounted for as a change in the corresponding capitalised cost, except where a reduction in the provision is greater than the undepreciated capitalised cost of the related assets, in which case the capitalised cost is reduced to nil and the remaining adjustment is recognised in the income statement. In the case of closed sites, changes to estimated costs are recognised immediately in the income statement. Changes to the capitalised cost result in an adjustment to future depreciation. Adjustments to the estimated amount and timing of future closure and rehabilitation cash flows are a normal occurrence in light of the significant judgements and estimates involved. Factors influencing those changes include:

- revisions to estimated resources and lives of operations;
- developments in technology;
- regulatory requirements and environmental management strategies;
- changes in the estimated extent and costs of anticipated activities, including the effects of inflation and movements in foreign exchange rates;
- movements in interest rates affecting the discount rate applied.

Financial instruments

All financial assets are initially recognised at the fair value of consideration paid. Subsequently, financial assets are carried at fair value or amortised cost less impairment. Where non-derivative financial assets are carried at fair value, gains and losses on remeasurement are recognised directly in equity unless the financial assets have been designated as being held at fair value through profit or loss, in which case the gains and losses are recognised directly in the income statement. Financial assets are designated as being held at fair value through profit or loss where this is necessary to reduce measurement inconsistencies for related assets and liabilities. All financial liabilities other than derivatives are initially recognised at fair value of consideration received net of transaction costs as appropriate (initial cost) and, with the exception of financial liabilities which have been designated in fair value hedging relationships, are subsequently carried at amortised cost.

Derivatives, including those embedded in other contractual arrangements but separated for accounting purposes because they are not clearly and closely related to the host contract, are initially recognised at fair value on the date the contract is entered into and are subsequently remeasured at their fair value. The method of recognising the resulting gain or loss on remeasurement depends on whether the derivative is designated as a hedging instrument, and, if so, the nature of the item being hedged. The measurement of fair value is based on quoted market prices. Where no price information is available from a quoted market source, alternative market mechanisms or recent comparable transactions, fair value is estimated based on South32's views on relevant future prices, net of valuation allowances to accommodate liquidity, modelling, credit and other risks implicit in such estimates.

Derivatives embedded within other contractual arrangements and the majority of commodity-based transactions executed through derivative contracts do not qualify for hedge accounting. Changes in the fair value of any derivative instrument that does not qualify for hedge accounting are recognised immediately in the income statement.

Available for sale and trading investments

Available for sale and trading investments are measured at fair value. Gains and losses on the remeasurement of trading investments are recognised directly in the income statement. Gains and losses on the remeasurement of available for sale investments are recognised directly in equity and subsequently recognised in the income statement when realised by sale or redemption, or when a reduction in fair value is judged to represent an impairment.

Application of critical accounting policies and estimates

The preparation of the historical combined financial information requires management to make judgements and estimates and form assumptions that affect the amounts of assets, liabilities, contingent liabilities, revenues and expenses reported in the financial information. On an ongoing basis, management evaluates its judgements and estimates in relation to assets, liabilities, contingent liabilities, revenue and expenses. Management bases its judgements and estimates on historical experience and on other factors it believes to be reasonable under the circumstances, the results of which form the basis of the reported amounts that are not readily apparent from other sources. Actual results may differ from these estimates under different assumptions and conditions.

South32 has identified the following critical accounting policies under which significant judgements, estimates and assumptions are made and where actual results may differ from these estimates under different assumptions and conditions and may materially affect financial results or the financial position reported in future periods.

Further details of the nature of these assumptions and conditions may be found in the relevant notes to the financial information.

Reserve estimates

Reserves are estimates of the amount of product that can be economically and legally extracted from South32's properties. In order to estimate reserves, estimates are required about a range of geological, technical and economic factors, including quantities, grades, production techniques, recovery rates, production costs, transport costs, commodity demand, commodity prices and exchange rates.

Estimating the quantity and/or grade of reserves requires the size, shape and depth of ore bodies or fields to be determined by analysing geological data such as drilling samples. This process may require complex and difficult geological judgements to interpret the data.

South32 determines and reports Ore Reserves in Australia under the ASX Listing Rules 2012 for minerals.

Because the economic assumptions used to estimate reserves change from period to period, and because additional geological data is generated during the course of operations, estimates of reserves may change from period to period. Changes in reported reserves may affect South32's financial results and financial position in a number of ways, including the following:

- Asset recoverable amounts may be affected due to changes in estimated future cash flows;
- Depreciation, depletion and amortisation charged in the income statement may change where such charges are determined on the units of production basis, or where the useful economic lives of assets change;
- Overburden removal costs recorded on the balance sheet or charged to the income statement may change due to changes in stripping ratios or the units of production basis of depreciation;
- Decommissioning, site restoration and environmental provisions may change where changes in estimated reserves affect expectations about the timing or cost of these activities;
- The carrying amount of deferred tax assets may change due to changes in estimates of the likely recovery of the tax benefits.

Exploration and evaluation expenditure

South32's accounting policy for exploration and evaluation expenditure results in certain items of expenditure being capitalised for an area of interest where it is considered likely to be recoverable by future exploitation or sale. This policy requires management to make certain estimates and assumptions as to future events and circumstances, in particular whether an economically viable extraction operation can be established. Any such estimates and assumptions may change as new information becomes available. If, after having capitalised the expenditure under the policy, a judgement is made that recovery of the expenditure is unlikely, the relevant capitalised amount will be written off to the income statement.

Development expenditure

Development activities commence after project sanctioning by the appropriate level of management. Judgement is applied by management in determining when a project is economically viable. In exercising this judgement, management is required to make certain estimates and assumptions similar to those described above for capitalised exploration and evaluation expenditure. Any such estimates and assumptions may change as new information becomes available. If, after having commenced the development activity, a judgement is made that a development asset is impaired, the appropriate amount will be written off to the income statement.

Property, plant and equipment and Intangible assets – recoverable amount

In accordance with South32's accounting policy, each asset or cash-generating unit is evaluated every reporting period to determine whether there are any indications of impairment or reversal of previously recognised impairment losses. If any such indication exists, a formal estimate of recoverable amount is performed. Where carrying amount exceeds recoverable amount an impairment loss is recognised. A reversal of previously recognised impairment loss is limited to the lesser of the amount that would not cause the increased carrying amount to exceed (a) its recoverable amount; or (b) the carrying amount that would have been determined (net of depreciation) had no impairment loss been recognised for the asset or cash-generating unit. The recoverable amount of an asset or cash-generating group of assets is measured at the higher of fair value less costs of disposal and value in use.

The determination of fair value and value in use requires management to make estimates and assumptions about expected production and sales volumes, commodity prices (considering current and historical prices, price trends and related factors), reserves (see 'Reserve estimates' above), operating costs, closure and rehabilitation costs and future capital expenditure. These estimates and assumptions are subject to risk and uncertainty; hence there is a possibility that changes in circumstances will alter these projections, which may impact the recoverable amount of the assets. In such circumstances, some or all of the carrying amount of the assets may be further impaired or the impairment charge reduced with the impact recorded in the income statement.

Defined benefit pension schemes

South32's accounting policy for defined benefit pension schemes requires management to make judgements as to the nature of benefits provided by each scheme and thereby determine the classification of each scheme. For defined benefit schemes, management is required to make annual estimates and assumptions about future returns on classes of scheme assets, future remuneration changes, employee attrition rates, administration costs, changes in benefits, inflation rates, exchange rates, life expectancy and expected

remaining periods of service of employees. In making these estimates and assumptions, management considers advice provided by external advisers, such as actuaries. Where actual experience differs to these estimates, actuarial gains and losses are recognised directly in equity. Refer to note 25 Pension and other post-retirement obligations for details of the key assumptions.

Provision for closure and rehabilitation

South32's accounting policy for the recognition of closure and rehabilitation provisions requires significant estimates and assumptions such as: requirements of the relevant legal and regulatory framework; the magnitude of possible contamination; and the timing, extent and costs of required closure and rehabilitation activity. These uncertainties may result in future actual expenditure differing from the amounts currently provided.

The provision recognised for each site is periodically reviewed and updated based on the facts and circumstances available at the time. Changes to the estimated future costs for operating sites are recognised in the balance sheet by adjusting both the closure and rehabilitation asset and provision. For closed sites, changes to estimated costs are recognised immediately in the income statement.

In addition to the uncertainties noted above, certain closure and rehabilitation activities are subject to legal disputes and depending on the ultimate resolution of these issues, the final liability for these matters could vary.

Taxation

South32's accounting policy for taxation, including royalty-related taxation, requires management's judgement as to the types of arrangements considered to be a tax on income in contrast to an operating cost. Judgement is also required in assessing whether deferred tax assets and certain deferred tax liabilities are recognised on the balance sheet. Deferred tax assets, including those arising from unrecouped tax losses, capital losses, foreign tax credits and temporary differences, are recognised only where it is considered more likely than not that they will be recovered, which is dependent on the generation of sufficient future taxable profits. Deferred tax liabilities arising from temporary differences in investments, caused principally by retained earnings held in foreign tax jurisdictions, are recognised unless repatriation of retained earnings can be controlled and are not expected to occur in the foreseeable future.

Assumptions about the generation of future taxable profits and repatriation of retained earnings depend on management's estimates of future cash flows. These depend on estimates of future production and sales volumes, commodity prices, reserves, operating costs, closure and rehabilitation costs, capital expenditure, dividends and other capital management transactions. Judgements are also required about the application of income tax legislation and its interaction with income tax accounting principles. These judgements and assumptions are subject to risk and uncertainty, hence there is a possibility that changes in circumstances will alter expectations, which may impact the amount of deferred tax assets and deferred tax liabilities recognised on the balance sheet and the amount of other tax losses and temporary differences not yet recognised. In such circumstances, some or all of the carrying amount of recognised deferred tax assets and liabilities may require adjustment, resulting in a corresponding credit or charge to the income statement.

Exchange rates

The following exchange rates relative to the US dollar have been applied in the historical combined financial information:

	Average year ended 30 June 2014	Average year ended 30 June 2013	Average year ended 30 June 2012	As at 30 June 2014	As at 30 June 2013	As at 30 June 2012
Australian dollar ^(a)	0.92	1.03	1.03	0.94	0.92	1.00
Brazilian real	2.29	2.04	1.78	2.20	2.18	2.08
Colombian peso	1,935	1,814	1,825	1,881	1,923	1,807
South African rand	10.39	8.84	7.77	10.60	10.00	8.41
Mozambican metical	30.63	29.56	27.36	31.55	29.80	27.95

(a) Displayed as US\$ to A\$1 based on common convention.

2 Segment reporting

Business segments

South32 operates the Businesses set out below. The reporting of financial information by Business reflects the proposed structure that will be used by South32's management to assess the performance of South32.

Reportable segment	Principal activities
Worsley Alumina	Integrated bauxite mine and alumina refinery in Western Australia
South Africa Aluminium	Two aluminium smelters at Richards Bay
Mozal Aluminium	Aluminium smelter near Maputo in Mozambique
Brazil Aluminium	Alumina refinery and aluminium smelter in Brazil
South Africa Energy Coal	Open-cut and underground energy coal mines and processing operations in South Africa
Illawarra Metallurgical Coal	Underground metallurgical coal mines in southern New South Wales
Australia Manganese	Producer of manganese ore in the Northern Territory and manganese alloys in Tasmania
South Africa Manganese	Integrated producer of manganese ore and alloy in South Africa
Cerro Matoso	Integrated laterite ferronickel mining and smelting complex in northern Colombia
Cannington	Silver, lead and zinc mine located in northwest Queensland

All South32 Businesses are operated or jointly operated by South32 except Alumar (which forms part of Brazil Aluminium), which is operated by Alcoa.

Group and unallocated items represent Group centre functions and consolidation adjustments. Exploration and technology activities are recognised within relevant segments.

It is South32's policy that inter-segment sales are made on a commercial basis.

US\$M	Worsley Alumina	South Africa Aluminium	Mozal Aluminium	Brazil Aluminium	South Africa Energy Coal	Illawarra Metallurgical Coal	Australia Manganese	South Africa Manganese	Cerro Matoso	Cannington	Group and unallocated items/ eliminations	Total South32
Year ended 30 June 2014												
Revenue												
Group Production	570	1,614	574	529	1,247	878	1,308	788	595	1,079	-	9,182
Third party products ^(a)	-	-	-	-	-	-	-	-	-	-	1,262	1,262
Inter-segment revenue	659	-	-	-	-	-	-	-	-	-	(659)	-
Total revenue	1,229	1,614	574	529	1,247	878	1,308	788	595	1,079	603	10,444
Underlying EBITDA^(b)	162	190	52	127	197	135	505	120	87	460	20	2,055
Depreciation and amortisation	(138)	(69)	(36)	(83)	(193)	(170)	(91)	(72)	(88)	(47)	2	(985)
Underlying EBIT^(b)	24	121	16	44	4	(35)	414	48	(1)	413	22	1,070
Comprising:												
Group Production	24	121	16	44	(6)	(35)	414	48	(1)	413	(7)	1,031
Third party products ^(a)	-	-	-	-	-	-	-	-	-	-	29	29
Share of operating profit of equity accounted investments	-	-	-	-	10	-	-	-	-	-	-	10
Underlying EBIT	24	121	16	44	4	(35)	414	48	(1)	413	22	1,070
Net finance costs ^(c)												(222)
Income tax expense												(234)
Underlying Earnings												614
Earnings adjustments												(397)
Profit/(Loss) after taxation												217
Capital expenditure	56	28	8	9	65	309	108	70	56	60	-	769
Investments accounted for using the equity method	-	-	-	-	10	-	-	-	-	-	-	10
Total assets^(d)	3,894	1,543	726	1,105	2,158	1,768	1,374	1,121	1,105	435	4,461	19,690
Total liabilities^(d)	476	348	99	137	1,169	384	549	331	245	201	5,931	9,870

US\$M	Worsley Alumina	South Africa Aluminium	Mozal Aluminium	Brazil Aluminium	South Africa Energy Coal	Illawarra Metallurgical Coal	Australia Manganese	South Africa Manganese	Cerro Matoso	Cannington	Group and unallocated items/ eliminations	Total South32
Year ended 30 June 2013												
Revenue												
Group Production	492	1,663	612	637	1,458	1,287	1,257	856	803	1,365	-	10,430
Third party products ^(a)	-	-	-	-	-	-	-	-	-	-	1,663	1,663
Inter-segment revenue	638	-	-	-	-	-	-	-	-	-	(638)	-
Total revenue	1,130	1,663	612	637	1,458	1,287	1,257	856	803	1,365	1,025	12,093
Underlying EBITDA^(b)	60	73	31	44	115	302	499	111	234	651	(2)	2,118
Depreciation and amortisation	(175)	(72)	(34)	(84)	(211)	(148)	(63)	(53)	(79)	(40)	(5)	(964)
Underlying EBIT^(b)	(115)	1	(3)	(40)	(96)	154	436	58	155	611	(7)	1,154
Comprising:												
Group Production	(115)	1	(3)	(40)	(96)	154	436	58	155	611	(70)	1,091
Third party products ^(a)											63	63
Share of operating profit of equity accounted investments	-	-	-	-	-	-	-	-	-	-	-	-
Underlying EBIT	(115)	1	(3)	(40)	(96)	154	436	58	155	611	(7)	1,154
Net finance costs ^(c)												(143)
Income tax expense												(256)
Underlying Earnings												755
Earnings adjustments												(2,059)
Profit/(Loss) after taxation												(1,304)
Capital expenditure	154	17	7	6	133	357	271	104	50	39	1	1,139
Investments accounted for using the equity method	-	-	-	-	-	-	-	-	-	-	-	-
Total assets^(d)	3,359	1,632	791	1,309	2,383	1,568	1,266	1,132	1,187	409	4,507	19,543
Total liabilities^(d)	491	250	122	278	1,049	330	420	287	197	203	5,796	9,423

US\$M	Worsley Alumina	South Africa Aluminium	Mozal Aluminium	Brazil Aluminium	South Africa Energy Coal	Illawarra Metallurgical Coal	Australia Manganese	South Africa Manganese	Cerro Matoso	Cannington	Group and unallocated items/ eliminations	Total South32
Year ended 30 June 2012												
Revenue												
Group Production	344	1,646	629	660	1,894	1,701	1,204	932	876	1,590	-	11,476
Third party products ^(a)	-	-	-	-	-	-	-	-	-	-	2,359	2,359
Inter-segment revenue	648	-	-	-	-	-	-	-	-	-	(648)	-
Total revenue	992	1,646	629	660	1,894	1,701	1,204	932	876	1,590	1,711	13,835
Underlying EBITDA^(b)	(67)	(10)	51	3	416	818	335	(18)	417	893	(7)	2,831
Depreciation and amortisation	(127)	(73)	(33)	(83)	(190)	(159)	(53)	(33)	(80)	(53)	(21)	(905)
Underlying EBIT^(b)	(194)	(83)	18	(80)	226	659	282	(51)	337	840	(28)	1,926
Comprising:												
Group Production	(194)	(83)	18	(80)	226	659	282	(51)	337	840	(122)	1,832
Third party products ^(a)	-	-	-	-	-	-	-	-	-	-	94	94
Share of operating profit of equity accounted investments	-	-	-	-	-	-	-	-	-	-	-	-
Underlying EBIT	(194)	(83)	18	(80)	226	659	282	(51)	337	840	(28)	1,926
Net finance costs ^(c)												(128)
Income tax expense												(540)
Underlying Earnings												1,258
Earnings adjustments												175
Profit/(Loss) after taxation												1,433
Capital expenditure	900	14	9	12	162	314	213	131	105	73	80	2,013
Investments accounted for using the equity method	-	-	-	-	-	-	-	-	-	-	-	-
Total assets^(d)	5,668	1,782	860	1,402	2,712	1,412	1,112	1,072	1,231	437	6,324	24,012
Total liabilities^(d)	563	254	83	258	1,287	354	491	286	228	243	6,153	10,200

- (a) Third party products purchased and sold by South32 Marketing comprise US\$802 million for aluminium (2013: US\$1,024 million; 2012: US\$1,487 million), US\$456 million for coal (2013: US\$585 million; 2012: US\$856 million) and US\$4 million for manganese (2013: US\$54 million; 2012: US\$16 million). Underlying EBIT on third party products comprise US\$14 million for aluminium (2013: US\$19 million; 2012: US\$ nil), US\$18 million for coal (2013: US\$44 million; 2012: US\$90 million) and a loss of US\$3 million for manganese (2013: US\$ nil; 2012: US\$4 million).
- (b) Underlying EBIT is earnings before net finance costs, taxation and any earnings adjustment items. Underlying EBIT is reported net of South32's share of net finance costs and taxation of equity accounted investments. Underlying EBITDA is Underlying EBIT, before depreciation and amortisation.
- (c) Excludes interest income and interest expense on borrowings with BHP Billiton. Refer to note 6 Net finance costs.
- (d) Total segment assets and liabilities represent operating assets and liabilities including the carrying amount of equity accounted investments and predominantly excludes cash balances, interest bearing liabilities and deferred tax balances. The carrying amount of investments accounted for using the equity method represents the balance of the Group's investment in equity accounted investments, with no adjustment for any cash balances, interest bearing liabilities and deferred tax balances of the equity accounted investment.

The following items are excluded from profit/(loss) from operations in arriving at Underlying EBIT each period irrespective of materiality:

- Exchange gains/losses on restatement of monetary items
- Impairment losses/reversals
- Net gains/loss on disposal and consolidation of interests in businesses
- Fair value gain/loss on derivative instruments
- Major corporate restructures

In addition to these, items that do not reflect the underlying operations of South32 and are individually significant to the financial statements are excluded. Such items included within South32's profit or loss for the Reporting Period are detailed in note 3 Significant items.

In calculating Underlying Earnings, adjustments are also made to dividend income, net finance costs and taxation for amounts with BHP Billiton that will not continue post Demerger and are not reflective of the underlying operations.

The following table shows earnings adjustments in arriving at Underlying Earnings:

US\$M	2014	2013	2012
Earnings adjustments to Underlying EBIT			
Exchange gains on restatement of monetary items	(68)	(97)	(100)
Impairment losses	327	2,225	108
Impairment reversals	(8)	(15)	-
Fair value (gain)/loss on derivative instruments	2	16	(122)
Dividend income from BHP Billiton	(11)	(12)	(20)
Other:			
Bayside closure costs (excluding impairments)	138	-	-
Gain on sale of Optimum coal rights	(84)	-	-
Total earnings adjustments to Underlying EBIT	296	2,117	(134)
Earnings adjustments to net finance costs			
Exchange variations on net debt	40	(16)	(44)
Interest on borrowings from BHP Billiton	115	108	76
Interest income on loans to BHP Billiton	(25)	(102)	(118)
Total earnings adjustments to net finance costs	130	(10)	(86)
Earnings adjustments to income tax expense			
Tax effect of earnings adjustments to Underlying EBIT	(21)	(528)	48
Tax effect of earnings adjustments to net finance costs	(39)	3	26
Exchange rate movements	4	84	123
Remeasurement of deferred tax assets associated with the MRRT	-	142	(196)
Non-recognition of tax benefits where benefit remains with BHP Billiton	27	251	44
Total earnings adjustments to income tax expense	(29)	(48)	45
Total earnings adjustments	397	2,059	(175)

Geographical information

	Revenue by location of customer		
	2014 US\$M	2013 US\$M	2012 US\$M
Australia	851	1,035	1,303
China	1,349	1,320	1,402
India	789	889	1,373
Japan	838	1,004	959
Middle East	482	638	803
Singapore	514	627	321
South Korea	691	733	893
Rest of Asia	386	567	594
United Kingdom	301	354	306
Europe	2,313	2,766	3,184
North America	542	526	750
Southern Africa	1,141	1,234	1,499
Rest of world	247	400	448
Total revenue	10,444	12,093	13,835

	Non-current assets by location of assets		
	2014 US\$M	2013 US\$M	2012 US\$M
Australia	6,852	5,122	7,559
Africa	4,519	5,597	5,430
South America	1,871	2,008	2,134
Unallocated assets ^(a)	1,446	1,580	1,345
Total non-current assets	14,688	14,307	16,468

(a) Unallocated assets predominantly comprise deferred tax assets and other financial assets.

3 Significant items

Significant items are those items where their nature and amount were considered material to the South32 historical combined financial information. Such items included within South32's profit/(loss) for the year are detailed below.

	2014 US\$M	2013 US\$M	2012 US\$M
Significant items by nature			
Impairment of South Africa Energy Coal assets	292	–	–
Impairment of Worsley Alumina assets	–	2,190	–
Impairment of Manganese assets	–	–	93
Bayside closure costs	167	–	–
Gain on sale of Optimum coal rights	(84)	–	–
Total significant items	375	2,190	93

30 June 2014

Impairment of South Africa Energy Coal assets comprise:

As part of South32's accounting policy to evaluate assets and cash generating units every reporting period to determine whether there are any indications of impairment, impairments of property, plant and equipment of US\$244 million and of goodwill of US\$48 million were recognised at South Africa Energy Coal as a result of royalty legislation changes, a decline in export prices, a required five per cent rail allocation to Junior BBEE miners and increased geologic loss.

Bayside closure costs:

As a result of the cessation of aluminium smelting activities at Bayside in June 2014, a charge of US\$167 million was recorded, representing an impairment of property, plant and equipment of US\$29 million in conjunction with other closure and cessation costs totalling US\$138 million.

Gain on sale of Optimum coal rights:

Following the Sale of the Optimum Colliery in FY2008, South32 retained the right to sell coal on behalf of the new owners, Optimum Coal Holdings (Pty) Ltd. This right has now been sold and generated a profit on disposal of US\$84 million.

30 June 2013

Impairment of Worsley Alumina assets:

South32 recognised an impairment of assets at Worsley Alumina as a result of expected continued strength in the Australian dollar and weak alumina prices. A total impairment charge of US\$2,190 million was recognised.

30 June 2012

Impairment of Manganese assets:

As part of the regular portfolio review, South32 temporarily suspended production at Australia Manganese, permanently closed the Metalloys South Plant at South Africa Manganese and terminated the Samancor Manganese Gabon project. As a result, impairment charges of US\$93 million were recognised.

4 Other income

	2014 US\$M	2013 US\$M	2012 US\$M
External dividend income	17	12	3
Dividend income from BHP Billiton	11	12	20
Gains/(losses) on sale of property, plant and equipment	20	32	(4)
Gains/(losses) on sale of investments	2	(3)	-
External other income	260	102	41
Total other income	310	155	60

5 Expenses

	2014 US\$M	2013 US\$M	2012 US\$M
Changes in inventories of finished goods and work in progress	6	188	175
Raw materials and consumables used	3,302	3,396	3,321
Employee benefits expense	1,471	1,577	1,530
Employee share awards	25	26	28
External services (including transportation)	1,837	2,438	2,734
Third party commodity purchases	1,233	1,601	2,265
Net foreign exchange gains	(68)	(97)	(100)
Research and development costs before crediting related grants	16	18	19
Fair value change on derivatives	2	16	(122)
Government royalties paid and payable	348	383	413
Reversal of previously impaired financial assets	(8)	-	-
Depreciation and amortisation expense	985	964	905
Exploration and evaluation expenditure incurred and expensed in the current period	17	21	41
Impairment of property, plant and equipment	279	2,225	108
Reversal of previously impaired property, plant and equipment	-	(15)	-
Impairment of goodwill and intangible assets	48	-	-
Operating lease rentals	94	97	96
All other operating expenses	403	373	422
Total expenses	9,990	13,211	11,835

6 Net finance costs

	2014	2013	2012
	US\$M	US\$M	US\$M
Financial expenses			
Interest on bank loans and overdrafts ^(a)	3	1	3
Interest on all other borrowings ^(a)	51	11	61
Finance lease and hire purchase interest	36	4	29
Discounting on provisions and other liabilities	137	143	142
Net interest expense on post-retirement employee benefits	11	12	12
Interest capitalised ^(b)	-	-	(82)
Exchange variations on net debt	40	(16)	(44)
Financial expenses excluding BHP Billiton	278	155	121
Interest on borrowings from BHP Billiton ^(c)	115	108	76
Total financial expenses	393	263	197
Financial income			
Interest income ^(d)	(16)	(28)	(37)
Interest income on loans to BHP Billiton ^(c)	(25)	(102)	(118)
Total financial income	(41)	(130)	(155)
Net finance costs	352	133	42

(a) Interest on bank loans and overdrafts, and other borrowings, relates to financial liabilities carried at amortised cost.

(b) Interest has been capitalised at the rate of interest applicable to the specific borrowings financing the assets under construction or, where financed through general borrowings, at a capitalisation rate representing the average interest rate on such borrowings. For the year ended 30 June 2012, the capitalisation rate was 2.83 per cent.

(c) Interest income and expense are based on historical funding which was provided to South32 under executed agreements between BHP Billiton and South32 at estimated arm's length interest rates. Refer to note 15 Interest bearing liabilities for details of outstanding debt balances with BHP Billiton.

(d) Interest income relates to financial assets carried at amortised cost.

7 Income tax and deferred tax

	2014	2013	2012
	US\$M	US\$M	US\$M
Total taxation expense comprises:			
Current tax expense	233	579	579
Deferred tax (benefit)/expense	(28)	(371)	6
Total taxation expense	205	208	585

	2014		2013		2012	
	%	US\$M	%	US\$M	%	US\$M
Factors affecting income tax expense for the period						
Income tax expense differs to the standard rate of corporation tax as follows:						
Profit/(loss) before taxation		422		(1,096)		2,018
Tax on profit/(loss) at standard rate of 30 per cent	30.0	127	30.0	(329)	30.0	605
Investment and development allowance	(0.7)	(3)	0.3	(3)	(0.1)	(2)
Amounts under/(over) provided in prior years	15.7	66	0.2	(2)	(0.8)	(16)
Initial recognition of tax assets	-	-	3.2	(35)	(5.5)	(110)
Non-deductible depreciation, amortisation and exploration expenditure	8.8	37	(9.6)	105	0.8	17
Tax rate differential on foreign income	(8.1)	(34)	2.2	(24)	(1.4)	(28)
Tax on remitted and unremitted foreign earnings	-	-	(0.6)	7	-	-
Non-tax-effected operating losses and capital gains	4.5	19	(23.8)	261	7.4	152
Exchange variations and other translation adjustments	1.0	4	(7.7)	84	6.1	123
Tax rate changes	-	-	2.1	(23)	-	-
Other	6.9	29	(2.3)	25	2.0	40
Income tax expense	58.1	245	(6.0)	66	38.7	781
Royalty-related taxation (net of income tax benefit)	(9.5)	(40)	(13.0)	142	(9.7)	(196)
Total taxation expense	48.6	205	(19.0)	208	29.0	585

Income tax recognised in other comprehensive income is as follows:

	2014 US\$M	2013 US\$M	2012 US\$M
Income tax effect of:			
Items that may be reclassified subsequently to the income statement:			
Available for sale investments:			
Net valuation gains/(losses) taken to equity	2	17	(15)
Net valuation gains transferred to the income statement	1	-	-
Income tax credit/(charge) relating to items that may be reclassified subsequently to the income statement	3	17	(15)
Items that will not be reclassified to the income statement:			
Actuarial gains on pension and medical schemes	-	-	5
Net accrued employee entitlement for share awards	-	-	1
Income tax credit relating to items that will not be reclassified to the income statement	-	-	6
Total income tax credit/(charge) relating to components of other comprehensive income^(a)	3	17	(9)

(a) Included within total income tax relating to components of other comprehensive income is US\$3 million relating to deferred taxes (2013: US\$17 million; 2012: US\$(9) million).

The movement for the year in South32's net deferred tax position is as follows:

	2014 US\$M	2013 US\$M	2012 US\$M
Net deferred tax asset			
At the beginning of the financial year	461	66	116
Income tax credit/(charge) recorded in the income statement	28	371	(6)
Income tax credit/(charge) recorded directly in equity	3	17	(9)
Other movements	(2)	7	(35)
At the end of the financial year	490	461	66

The composition of South32's net deferred tax asset and liability recognised in the balance sheet and the deferred tax expense charged/(credited) to the income statement is as follows:

	Deferred tax assets			Deferred tax liabilities			Charged/(credited) to the income statement		
	2014 US\$M	2013 US\$M	2012 US\$M	2014 US\$M	2013 US\$M	2012 US\$M	2014 US\$M	2013 US\$M	2012 US\$M
Type of temporary difference									
Depreciation	297	647	225	630	659	809	321	(571)	52
Exploration expenditure	-	-	10	-	-	-	-	-	8
Employee benefits	71	81	64	(65)	(46)	(66)	(9)	(1)	8
Closure and rehabilitation	232	240	145	(212)	(163)	(249)	(22)	(11)	36
Resource rent tax	137	41	196	43	(13)	-	(40)	142	(196)
Other provisions	260	13	3	(21)	(9)	(9)	(259)	(10)	(5)
Deferred income	(1)	-	1	(1)	(1)	-	1	-	-
Deferred charges	-	-	(114)	163	142	-	20	28	18
Foreign exchange gains and losses	-	(1)	2	(1)	(3)	8	1	(9)	(10)
Non tax-depreciable fair value adjustments, revaluations and mineral rights	-	(1)	-	9	33	48	(25)	(14)	98
Tax-effected losses	53	87	101	(41)	(33)	(35)	4	15	142
Other	(36)	(66)	(20)	19	14	41	(20)	60	(145)
Total	1,013	1,041	613	523	580	547	(28)	(371)	6

The composition of South32's unrecognised deferred tax assets and liabilities is as follows:

	2014 US\$M	2013 US\$M	2012 US\$M
Unrecognised deferred tax assets			
Tax losses and tax credits	17	38	15
Investments in subsidiaries	155	204	113
Deductible temporary differences relating to MRRT	1,008	1,000	760
Other deductible temporary differences	624	617	649
Total unrecognised deferred tax assets	1,804	1,859	1,537
Unrecognised deferred tax liabilities			
Taxable temporary differences relating to unrecognised deferred tax asset for MRRT	(302)	(300)	(228)
Investments in subsidiaries	(243)	(219)	(206)
Total unrecognised deferred tax liabilities	(545)	(519)	(434)

Tax losses

At 30 June 2014, South32 had income and capital tax losses with a tax benefit of US\$17 million (2013: US\$38 million, 2012: US\$15 million) which are not recognised as deferred tax assets. South32 has recognised the benefit of tax losses only to the extent BHP Billiton has anticipated sufficient future taxable income or gains in relevant jurisdictions. The gross amount of tax losses carried forward that have not been tax-effected expire as follows:

Year of expiry	2014 US\$M	2013 US\$M	2012 US\$M
Income tax losses			
Not later than one year	-	110	-
Later than two years and not later than five years	-	-	43
Unlimited	61	-	-
Gross amount of tax losses not recognised	61	110	43
Tax effect of total losses not recognised	17	38	15

Temporary differences relating to MRRT:

At 30 June 2014, South32 had US\$1,008 million of unrecognised deductible temporary differences (2013: US\$1,000 million, 2012: US\$760 million) relating to the Australian MRRT with a corresponding unrecognised deferred tax liability for income tax purposes of US\$302 million (2013: US\$300 million, 2012: US\$228 million). Recognition of a deferred tax asset for MRRT depends on benefits expected to be obtained from the deduction against MRRT liabilities.

Other deductible temporary differences:

At 30 June 2014, South32 had deductible temporary differences for which deferred tax assets of US\$624 million (2013: US\$617 million, 2012: US\$649 million) have not been recognised because it is not probable that future taxable profits will be available against which South32 can utilise the benefits. The deductible temporary differences do not expire under current tax legislation.

Temporary differences associated with investments in subsidiaries

At 30 June 2014, deferred tax liabilities of US\$243 million (2013: US\$219 million, 2012: US\$ 206 million) associated with undistributed earnings of subsidiaries have not been recognised because the South32 Group is able to control the timing of the reversal of the temporary differences and it is not probable that such differences will reverse in the foreseeable future.

8 Earnings, dividends and asset information per share

	2014	2013	2012
Basic earnings/(loss) per share (US cents)	2.48	(27.55)	26.31
Diluted earnings/(loss) per share (US cents)	2.47	(27.46)	26.20
Basic earnings/(loss) (US\$M)	132	(1,467)	1,401
Diluted earnings/(loss) (US\$M)	132	(1,467)	1,401
Headline earnings per share (US cents)	7.48	3.32	28.32
Headline earnings (US\$M)	398	177	1,508
Net asset value per share (US cents) ^(a)	184	190	259
Tangible net asset value per share (US cents) ^(b)	179	184	253
Dividends paid per share (US cents) ^(c)	9	43	1

(a) Net asset value per share is calculated by dividing South32's total net assets by the basic number of ordinary shares outstanding.

(b) Tangible net asset value per share is calculated by dividing South32's total net assets less intangible assets by the basic number of ordinary shares outstanding.

(c) Dividends per share are calculated by dividing South32's dividends paid by the basic number of ordinary shares outstanding.

The number of shares used for the purpose of calculating amounts per share is based on the proposed capital structure of South32 at the time of Demerger being a one for one share issue as follows:

	2014 Million	2013 Million	2012 Million
Weighted average number of ordinary shares			
Basic/headline earnings per share denominator	5,324	5,324	5,324
Shares and options contingently issuable under employee share ownership plans	17	18	23
Diluted earnings per share denominator	5,341	5,342	5,347

Headline earnings

Headline earnings per share has been calculated in accordance with the South African Circular 2/2013 entitled 'Headline Earnings' which forms part of the listing requirements for the JSE. The adjustments made to arrive at headline earnings are as follows:

	2014 US\$M		2013 US\$M		2012 US\$M	
	Gross	Net	Gross	Net	Gross	Net
Profit/(loss) for the year attributable to members of South32		132		(1,467)		1,401
Headline earnings adjustments:						
Impairment of intangible assets ^(a)	48	48	-	-	-	-
Impairment of property, plant and equipment ^(a)	279	225	2,210	1,666	108	102
Loss on cessation of operations ^(b)	8	8	-	-	-	-
(Gain)/loss on disposal of property, plant and equipment	(20)	(14)	(32)	(22)	7	5
Net profit on disposal of business	(1)	(1)	-	-	-	-
Headline earnings		398		177		1,508

(a) Refer to note 3 Significant items and note 5 Expenses.

(b) The aluminium smelting activities at Bayside ceased in June 2014.

9 Trade and other receivables

	2014 US\$M	2013 US\$M	2012 US\$M
Current			
Trade receivables	623	706	921
Other receivables	288	543	788
Trade and other receivables	911	1,249	1,709
Trade receivables from BHP Billiton ^(a)	869	982	890
Interest bearing loans receivable from BHP Billiton ^(a)	1,074	827	2,663
Receivables from BHP Billiton	1,943	1,809	3,553
Total current receivables	2,854	3,058	5,262
Non-current			
Trade receivables	-	43	63
Interest bearing loans receivable	67	88	82
Other receivables	111	51	73
Total non-current receivables	178	182	218

(a) Disclosures relating to receivables due from BHP Billiton are set out in note 24 Related party balances and transactions.

10 Other financial assets

	2014 US\$M	2013 US\$M	2012 US\$M
Current			
At fair value			
Forward exchange contracts	–	1	5
Commodity contracts	–	19	61
Other derivative contracts	13	8	7
Shares – available for sale	–	37	–
Total current other financial assets	13	65	73
Non-current			
At fair value			
Commodity contracts	–	–	39
Other derivative contracts	41	44	55
Shares – available for sale	317	358	493
Other investments – available for sale ^(a)	144	137	145
Total non-current other financial assets	502	539	732

(a) Represents investments held by BHP Billiton Energy Coal South Africa Rehabilitation Trust Fund. The future realisation of this investment is intended to fund environmental obligations relating to the closure of the South African coal operations, and consequently this investment, while under South32's control, is not available for the general purposes of South32. Any income from this investment is reinvested or applied to meet these obligations. South32 retains responsibility for these environmental obligations until such time as the former mine sites have been rehabilitated in accordance with the relevant environmental legislation. These obligations are therefore included under non-current provisions. Refer to note 17 Provisions.

11 Inventories

		2014 US\$M	2013 US\$M	2012 US\$M
Current				
Raw materials and consumables	– at net realisable value ^(a)	35	4	76
	– at cost	514	650	567
		549	654	643
Work in progress	– at net realisable value ^(a)	7	16	143
	– at cost	400	343	216
		407	359	359
Finished goods	– at net realisable value ^(a)	121	52	307
	– at cost	350	485	414
		471	537	721
Total current inventories		1,427	1,550	1,723
Non-current				
Raw materials and consumables	– at cost	20	77	87
		20	77	87
Work in progress	– at cost	38	–	–
		38	–	–
Total non-current inventories		58	77	87

(a) US\$26 million of inventory write-downs were recognised during the year (2013: US\$3 million; 2012: US\$18 million). Inventory write-downs of US\$7 million made in previous periods were reversed during the year (2013: US\$16 million; 2012: US\$ nil).

12 Property, plant and equipment

Year ended 30 June 2014	Land and buildings US\$M	Plant and equipment US\$M	Other mineral assets US\$M	Assets under construction US\$M	Exploration and evaluation US\$M	Total US\$M
Cost						
At the beginning of the financial year	2,706	15,492	2,718	1,300	33	22,249
Additions	–	979	145	652	6	1,782
Disposals	(24)	(104)	(68)	–	–	(196)
Transfers and other movements	207	735	12	(929)	(6)	19
At the end of the financial year	2,889	17,102	2,807	1,023	33	23,854
Accumulated depreciation and impairments						
At the beginning of the financial year	(1,098)	(7,704)	(1,346)	–	–	(10,148)
Charge for the year	(119)	(754)	(108)	–	–	(981)
Impairments for the year	(122)	(110)	(47)	–	–	(279)
Disposals	5	96	68	–	–	169
Transfers and other movements	(1)	2	–	–	–	1
At the end of the financial year	(1,335)	(8,470)	(1,433)	–	–	(11,238)
Net book value at 30 June 2014	1,554	8,632	1,374	1,023	33	12,616

Year ended 30 June 2013	Land and buildings US\$M	Plant and equipment US\$M	Other mineral assets US\$M	Assets under construction US\$M	Exploration and evaluation US\$M	Total US\$M
Cost						
At the beginning of the financial year	2,788	14,591	2,613	1,519	104	21,615
Additions	–	–	200	877	8	1,085
Amounts capitalised for closure provisions	–	(233)	–	–	–	(233)
Disposals	(6)	(138)	(27)	–	–	(171)
Transfers and other movements	(76)	1,272	(68)	(1,096)	(79)	(47)
At the end of the financial year	2,706	15,492	2,718	1,300	33	22,249
Accumulated depreciation and impairments						
At the beginning of the financial year	(889)	(5,276)	(988)	–	–	(7,153)
Charge for the year	(112)	(754)	(95)	–	–	(961)
Impairments for the year	(121)	(1,778)	(326)	–	–	(2,225)
Reversal of impairments	–	15	–	–	–	15
Disposals	4	114	21	–	–	139
Transfers and other movements	20	(25)	42	–	–	37
At the end of the financial year	(1,098)	(7,704)	(1,346)	–	–	(10,148)
Net book value at 30 June 2013	1,608	7,788	1,372	1,300	33	12,101

Year ended 30 June 2012	Land and buildings US\$M	Plant and equipment US\$M	Other mineral assets US\$M	Assets under construction US\$M	Exploration and evaluation US\$M	Total US\$M
Cost						
At the beginning of the financial year	2,397	11,241	2,708	3,665	93	20,104
Additions	1	26	138	1,881	11	2,057
Disposals	(6)	(338)	(222)	-	-	(566)
Transfers and other movements	396	3,662	(11)	(4,027)	-	20
At the end of the financial year	2,788	14,591	2,613	1,519	104	21,615
Accumulated depreciation and impairments						
At the beginning of the financial year	(727)	(4,854)	(1,107)	-	-	(6,688)
Charge for the year	(110)	(677)	(115)	-	-	(902)
Impairments for the year	(3)	(105)	-	-	-	(108)
Disposals	6	333	222	-	-	561
Transfers and other movements	(55)	27	12	-	-	(16)
At the end of the financial year	(889)	(5,276)	(988)	-	-	(7,153)
Net book value at 30 June 2012	1,899	9,315	1,625	1,519	104	14,462

13 Intangible assets

	2014			2013			2012		
	Goodwill US\$M	Other intangibles US\$M	Total US\$M	Goodwill US\$M	Other intangibles US\$M	Total US\$M	Goodwill US\$M	Other intangibles US\$M	Total US\$M
Cost									
At the beginning of the financial year	267	119	386	267	101	368	266	102	368
Additions	-	-	-	-	20	20	1	-	1
Disposals	-	-	-	-	(2)	(2)	-	(1)	(1)
Impairments for the year ^(a)	(48)	-	(48)	-	-	-	-	-	-
At the end of the financial year	219	119	338	267	119	386	267	101	368
Accumulated amortisation and impairments									
At the beginning of the financial year	-	(43)	(43)	-	(42)	(42)	-	(40)	(40)
Disposals	-	-	-	-	2	2	-	1	1
Charge for the year	-	(4)	(4)	-	(3)	(3)	-	(3)	(3)
At the end of the financial year	-	(47)	(47)	-	(43)	(43)	-	(42)	(42)
Total intangible assets	219	72	291	267	76	343	267	59	326

(a) In FY2014 an impairment of goodwill of US\$48 million was recognised at Energy Coal South Africa as part of the annual assessment for impairment of the carrying amount of assets and cash generating units.

The carrying amount of goodwill has been allocated to the South32 Businesses as follows:

South32 Business	2014 US\$M	2013 US\$M	2012 US\$M
Aluminium South Africa	139	139	139
Manganese South Africa	74	74	74
Energy Coal South Africa	6	54	54
Total goodwill	219	267	267

Impairment testing of goodwill

For the purpose of impairment testing, goodwill has been allocated to cash generating units ('CGUs'), or groups of CGUs that are expected to benefit from the synergies of the business combination and which represent the level at which management will monitor and manage the goodwill.

Impairment of non-financial assets

South32 recognised an impairment of assets at its Wolvekrans Middelburg Complex CGU (WMC CGU) of US\$292 million in the year ended 30 June 2014, as a result of royalty legislation changes, a decline in export prices, a required five per cent rail allocation to Junior BBEE miners and increased geologic loss. The WMC CGU consists of the Wolvekrans and Middelburg open cast collieries and South Africa Energy Coal. South32's determination of CGUs remains unchanged from prior periods.

The recoverable amount of the WMC CGU was determined as US\$735 million based on its fair value less cost of disposal. The value is based on South32's annual business valuation model using a discounted cash flow model with a discount rate of 9.5 per cent. The key assumptions used for export coal prices and exchange rates are comparable to the market consensus forecasts.

14 Trade and other payables

	2014 US\$M	2013 US\$M	2012 US\$M
Current			
Trade creditors	931	957	1,129
Other creditors	380	629	882
Trade and other payables	1,311	1,586	2,011
Payable to BHP Billiton ^(a)	28	10	13
Total current payables	1,339	1,596	2,024
Non-current			
Other creditors	56	8	19
Total non-current payables	56	8	19

(a) Disclosures relating to payables owing to BHP Billiton are set out in note 24 Related party balances and transactions.

15 Interest bearing liabilities

	2014	2013	2012
	US\$M	US\$M	US\$M
Current			
Unsecured bank loans	30	14	73
Secured bank loans ^(a)	–	20	20
Finance leases	15	1	3
Unsecured other	2	58	89
Unsecured bank overdrafts and short-term borrowings	–	–	19
Interest bearing liabilities	47	93	204
Interest bearing liabilities payable to BHP Billiton ^(b)	–	341	–
Total current interest bearing liabilities	47	434	204
Non-current			
Unsecured bank loans	250	30	–
Secured bank loans	–	–	20
Finance leases	788	32	35
Unsecured other ^(c)	215	219	259
Interest bearing liabilities	1,253	281	314
Interest bearing liabilities payable to BHP Billiton ^(b)	3,728	4,000	4,071
Total non-current interest bearing liabilities	4,981	4,281	4,385

(a) Secured bank loans for 2013 include US\$20 million secured by pledge over the assets of Mozal SARL joint operation. The bank loan was repaid during the 2014 financial year. As at 30 June 2014, the pledge over the assets has not yet been released.

(b) All interest bearing balances owed to BHP Billiton were historically provided under executed agreements between counterparties at arms-length interest rates. Refer to Note 24 Related party balances and transactions.

(c) Includes US\$60 million (2013: US\$66 million; 2012: US\$ nil) share of bank loans and other borrowings arranged by joint operations to fund the financing of joint operations. While South32 chose to finance the joint operations directly and not to participate in the external borrowing programs arranged by the joint operations, it recognises its share of those borrowings in accordance with the terms of each arrangement, which are usually in proportion to South32's interest in the joint operation. A corresponding amount is recognised in interest bearing loans receivables. Refer to note 9 Trade and other receivables, reflecting the direct funding of South32's contribution to each joint operation.

16 Other financial liabilities

	2014	2013	2012
	US\$M	US\$M	US\$M
Current			
Commodity contracts	–	–	42
Other derivative contracts	4	–	1
Total current other financial liabilities	4	–	43
Non-current			
Commodity contracts	–	–	11
Other derivative contracts	6	7	9
Total non-current other financial liabilities	6	7	20

17 Provisions

	2014 US\$M	2013 US\$M	2012 US\$M
Current			
Employee benefits ^(a)	302	307	292
Restructuring ^(b)	16	–	13
Closure and rehabilitation ^(c)	156	198	213
Post-retirement employee benefits ^(d)	8	8	9
Other	55	80	89
Total current provisions	537	593	616
Non-current			
Employee benefits ^(a)	5	3	4
Closure and rehabilitation ^(c)	2,036	1,635	1,853
Post-retirement employee benefits ^(d)	125	130	165
Other	4	11	10
Total non-current provisions	2,170	1,779	2,032

(a) The expenditure associated with total employee benefits will occur in a pattern consistent with when employees choose to exercise their entitlement to benefits.

(b) Total restructuring provisions include provisions for business terminations and office closures.

(c) Total closure and rehabilitation provisions include provision for closed sites of US\$381 million (2013: US\$186 million; 2012: US\$189 million).

(d) The provision for post-retirement employee benefits includes pension assets of US\$30 million (2013: US\$21 million; 2012: liability US\$3 million) and post-retirement medical benefit liabilities of US\$163 million (2013: US\$159 million; 2012: US\$171 million) – refer to note 25 Pension and other post-retirement obligations.

Year ended 30 June 2014	Employee benefits US\$M	Restructuring US\$M	Closure and rehabilitation US\$M	Post- retirement employee benefits US\$M	Other US\$M	Total US\$M
At the beginning of the financial year	310	–	1,833	138	91	2,372
Amounts capitalised	–	–	224	–	–	224
Charge/(credit) for the year:						
Underlying	266	7	94	5	34	406
Discounting	–	–	137	–	–	137
Net interest expense	–	–	–	11	–	11
Exchange variations	(1)	–	(11)	(7)	(4)	(23)
Released during the year	–	–	–	–	(26)	(26)
Actuarial loss taken to retained earnings	–	–	–	2	–	2
Utilisation	(248)	(8)	(92)	(14)	(30)	(392)
Transfers and other movements	(20)	17	7	(2)	(6)	(4)
At the end of the financial year	307	16	2,192	133	59	2,707

Year ended 30 June 2013	Employee benefits US\$M	Restructuring US\$M	Closure and rehabilitation US\$M	Post- retirement employee benefits US\$M	Other US\$M	Total US\$M
At the beginning of the financial year	296	13	2,066	174	99	2,648
Amounts capitalised	-	-	(251)	-	-	(251)
Charge/(credit) for the year:						
Underlying	294	4	24	7	100	429
Discounting	-	-	143	-	-	143
Net interest expense	-	-	-	12	-	12
Exchange variations	(36)	-	(30)	(24)	(9)	(99)
Released during the year	(2)	-	(29)	-	(19)	(50)
Actuarial gain taken to retained earnings	-	-	-	(2)	-	(2)
Utilisation	(240)	(7)	(112)	(30)	(70)	(459)
Transfers and other movements	(2)	(10)	22	1	(10)	1
At the end of the financial year	310	-	1,833	138	91	2,372

Year ended 30 June 2012	Employee benefits US\$M	Restructuring US\$M	Closure and rehabilitation US\$M	Post- retirement employee benefits US\$M	Other US\$M	Total US\$M
At the beginning of the financial year	315	-	2,081	200	103	2,699
Amounts capitalised	-	-	28	-	-	28
Charge/(credit) for the year:						
Underlying	187	15	3	7	35	247
Discounting	-	-	142	-	-	142
Net interest expense	-	-	-	12	-	12
Exchange variations	(22)	-	(43)	(38)	(17)	(120)
Released during the year	(18)	-	(10)	-	-	(28)
Actuarial loss taken to retained earnings	-	-	-	12	-	12
Utilisation	(161)	(2)	(134)	(19)	(23)	(339)
Transfers and other movements	(5)	-	(1)	-	1	(5)
At the end of the financial year	296	13	2,066	174	99	2,648

18 Contingent liabilities

Contingent liabilities at balance date, not otherwise provided for in the financial statements, are categorised as arising from:

	2014 US\$M	2013 US\$M	2012 US\$M
Subsidiaries and joint operations			
Bank guarantees	4	4	29
Actual or potential litigation ^(a)	587	622	643
Other	13	12	31
Total contingent liabilities	604	638	703

(a) Actual or potential litigation amounts relate to a number of actions against South32, some of which relate to commercially confidential information, none of which were individually significant to BHP Billiton and where BHP Billiton has historically assessed that the liability is not probable and therefore South32 has not provided for such amounts in the historical combined financial statements. The actual or potential litigation relates primarily to numerous tax assessments or matters arising from tax audits relating to transactions in prior years in Brazil, Colombia and South Africa. Additionally, there are a number of legal claims or potential claims against South32, the outcome of which cannot be foreseen at present, and for which no amounts have been included in the table above.

19 Commitments

	2014 US\$M	2013 US\$M	2012 US\$M
Capital expenditure commitments	149	229	366
Lease expenditure commitments			
Finance leases^(a)			
Due not later than one year	84	4	5
Due later than one year and not later than two years	84	4	5
Due later than two years and not later than three years	84	5	5
Due later than three years and not later than four years	82	4	5
Due later than four years and not later than five years	91	4	30
Due later than five years	1,447	37	17
Total commitments under finance leases	1,872	58	67
Future financing charges	(1,069)	(25)	(29)
Finance lease liability	803	33	38
Operating leases^(b)			
Due not later than one year	25	59	64
Due later than one year and not later than two years	21	47	52
Due later than two years and not later than three years	11	35	49
Due later than three years and not later than four years	8	10	35
Due later than four years and not later than five years	5	9	12
Due later than five years	14	30	41
Total commitments under operating leases	84	190	253

(a) Finance leases include leases of power generation and transmission assets. Lease payments are subject to inflation escalation clauses on which contingent rentals are determined. The leases contain extension and renewal options.

(b) Operating leases include property, plant and equipment. Rental payments are generally fixed, but with inflation escalation clauses on which contingent rentals are determined. Certain leases contain extension and renewal options.

20 Notes to the combined cash flow statement

Cash and cash equivalents

For the purpose of the combined cash flow statement, cash equivalents include highly liquid investments that are readily convertible to cash and with a maturity of less than 90 days, bank overdrafts and interest bearing liabilities at call.

	2014 US\$M	2013 US\$M	2012 US\$M
Cash and cash equivalents comprise:			
Cash	344	336	337
Short-term deposits	9	9	9
Total cash and cash equivalents^(a)	353	345	346
Bank overdrafts and short-term borrowings – refer to note 15			
Interest bearing liabilities	–	–	(19)
Total cash and cash equivalents, net of overdrafts	353	345	327

(a) Cash and cash equivalents include US\$28 million (2013: US\$36 million; 2012: US\$41 million) which is restricted by legal or contractual arrangements.

Significant non-cash investing and financing transactions

Property, plant and equipment of US\$768 million (2013: US\$ nil; 2012: US\$28 million) was acquired under finance leases.

Property, plant and equipment of US\$ nil (2013: US\$49 million; 2012: US\$ nil) was acquired under vendor financing arrangements.

21 Subsidiaries

Significant subsidiaries of South32, which are those with the most significant contribution to South32's net profit or net assets, including entities which will become subsidiaries on the effective date of the Demerger are as follows:

Name	Country of incorporation	Principal activity	Effective interest		
			2014 %	2013 %	2012 %
BHP Billiton Aluminium (RAA) Pty Ltd	Australia	Bauxite mining and alumina refining	100	100	100
BHP Billiton Aluminium (Worsley) Pty Ltd	Australia	Bauxite mining and alumina refining	100	100	100
BHP Billiton Australia Investment 3 Pty Ltd	Australia	Holding company	100	100	100
BHP Billiton Energy Coal South Africa Proprietary Limited ^(a)	South Africa	Coal mining	100	100	100
BHP Billiton Metas SA	Brazil	Alumina refining and aluminium smelting	100	100	100
BHP Billiton SA Holdings Limited	South Africa	Holding company	100	100	100
BHP Billiton SA Limited	South Africa	Holding and service company	100	100	100
Billiton Aluminium SA (Pty) Ltd	South Africa	Aluminium smelting	100	100	100
Billiton Coal SA Ltd	South Africa	Finance	100	100	100
Cerro Matoso SA	Colombia	Nickel mining and ferro-nickel smelting	99.9	99.9	99.9
Dendrobium Coal Pty Ltd	Australia	Coal mining	100	100	100
Endeavour Coal Pty Ltd	Australia	Coal mining	100	100	100
Groote Eylandt Mining Company Pty Ltd	Australia	Manganese mining	60	60	60
Hillside Aluminium (Pty) Ltd	South Africa	Aluminium smelting	100	100	100
Hotazel Manganese Mines (Proprietary) Limited ^(a)	South Africa	Manganese ore mining and processing	54.6	54.6	54.6
Illawarra Coal Holdings Pty Ltd	Australia	Coal mining	100	100	100

Name	Country of incorporation	Principal activity	Effective interest		
			2014 %	2013 %	2012 %
Illawarra Services Pty Ltd	Australia	Coal mining	100	100	100
Samancor AG	Switzerland	Marketing	60	60	60
Samancor Holdings (Proprietary) Limited	South Africa	Holding company	60	60	60
Samancor Manganese (Proprietary) Limited	South Africa	Manganese mining and manganese alloys	60	60	60
Tasmanian Electro Metallurgical Company Pty Ltd	Australia	Manganese alloys	60	60	60

(a) South32's effective interest in BHP Billiton Energy Coal South Africa Proprietary Limited will reduce to 90 per cent and effective interest in Hotazel Manganese Mines (Proprietary) Limited will reduce to 44.4 per cent pursuant to BBBEE transactions in South Africa.

22 Interests in joint operations

Significant joint operations of South32, which are those with the most significant contributions to South32's net profit or net assets, are as follows:

Name	Country of operation	Principal activity	Effective interest		
			2014 %	2013 %	2012 %
Alumar	Brazil	Alumina refining	36	36	36
		Aluminium smelting	40	40	40
Mozal SARL ^(a)	Mozambique	Aluminium smelting	47.1	47.1	47.1
Phola Coal Processing Plant (Pty) Ltd ^(a)	South Africa	Coal handling and processing plant	50	50	50
Worsley Alumina ^(b)	Australia	Bauxite mining and alumina refining	86	86	86

(a) These joint arrangements are separate vehicles however they are classified as joint operations as the participants to the arrangements are entitled to receive output, not dividends, from the arrangements.

(b) Whilst South32 holds a greater than 50 per cent interest in this joint operation, all the participants in the joint operation approve the operating and capital budgets and therefore South32 has joint control over the relevant activities of this arrangement.

Assets held in joint operations subject to significant restrictions are as follows:

	2014 US\$M	2013 US\$M	2012 US\$M
Current assets	657	860	786
Non-current assets	5,421	5,743	7,752
Total assets (South32 share)^(a)	6,078	6,603	8,538

(a) Whilst South32 is unrestricted in its ability to sell a share of its interest in these joint operations, it does not have the right to sell individual assets which are used in these joint operations without the unanimous consent of the other participants. The assets in these joint operations are also restricted to the extent that they are only available to be used by the joint operation itself and not by other operations of South32.

23 Financial risk management

Financial risk management strategy

Historically, risk management strategies have been adopted by BHP Billiton to reduce the BHP Billiton Group's exposure, which included exposures resulting from South32's operations, to the risks which arise in the normal course of business.

During the Reporting Periods, South32's risk management strategy (as a component of the BHP Billiton Group) was managed on the basis of policies and authorities approved by the BHP Billiton Board. These policies and authorities have been used to prepare the historical combined financial information and relevant disclosures of South32. These policies are expected to be adopted by South32 in substantially the same form post Demerger. The financial risks arising from South32's operations comprise market, liquidity and credit risk. These risks arise in the normal course of business, and South32's exposure to these risks has been managed in accordance with BHP Billiton's portfolio risk management strategy. The objective of BHP Billiton's strategy has been to support

the delivery of BHP Billiton's financial targets while protecting its future financial security and flexibility by taking advantage of the natural diversification provided by the scale, diversity and flexibility of BHP Billiton's operations and activities.

A Cash Flow at Risk (CFaR) framework has been used by BHP Billiton to measure the aggregate and diversified impact of financial risks upon BHP Billiton's financial targets. The principal measurement of risk is CFaR measured on a portfolio basis, which is defined as the worst expected loss relative to projected business plan cash flows over a one-year horizon under normal market conditions at a confidence level of 95 per cent.

Market risk

South32's activities expose it to market risks associated with movements in foreign currencies, commodity prices and interest rates. Operating under the BHP Billiton risk management strategy outlined above, BHP Billiton has sought to achieve financing costs, currency impacts, input costs and commodity prices on a floating or index basis. This strategy gives rise to a risk of variability in earnings which is measured under the CFaR framework.

In executing the strategy, financial instruments have been potentially employed in three distinct but related activities. The following table summarises these activities and the key risk management processes.

Activity	Key risk management processes
1 Risk mitigation	
On an exception basis, hedging for the purposes of mitigating risk related to specific and significant expenditure on investments or capital projects will be executed if necessary to support BHP Billiton's strategic objectives.	<ul style="list-style-type: none"> • Execution of transactions within approved mandates.
2 Economic hedging of commodity sales, operating costs and debt instruments	
Where South32 commodity production is sold to customers on pricing terms that deviate from the relevant index target, and where a relevant derivatives market exists, financial instruments may be executed as an economic hedge to align the revenue price exposure with the index target.	<ul style="list-style-type: none"> • Measuring and reporting the exposure in customer commodity contracts and issued debt instruments.
Where debt is issued in a currency other than the US dollar and/or at a fixed interest rate, fair value and cash flow hedges may be executed to align the debt exposure with South32's functional currency of US dollars and/or to swap to a floating interest rate. As part of this strategy swaptions may also be used.	<ul style="list-style-type: none"> • Executing hedging derivatives to align the total group exposure to the index target.
3 Strategic financial transactions	
Opportunistic transactions may be executed with financial instruments to capture value from perceived market over/under valuations.	<ul style="list-style-type: none"> • Exposures managed within value at risk and stop loss limits. • Execution of transactions within approved mandates.

Historically, primary responsibility for identification and control of financial risks, including authorising and monitoring the use of financial instruments for the above activities and stipulating policy thereon, has rested with the BHP Billiton Financial Risk Management Committee under authority delegated by the BHP Billiton Group Management Committee.

Currency risk

The US dollar is the functional currency of the operations within South32 and as a result currency exposures arise from transactions and balances in currencies other than the US dollar. South32's potential currency exposures comprise:

- translational exposure in respect of non-US dollar monetary items; and
- transactional exposure in respect of non-US dollar expenditure and revenues.

South32's foreign currency risk was historically managed as part of the portfolio risk management strategies enacted by BHP Billiton.

Translational exposure in respect of non-US dollar monetary items

Non-US dollar monetary items are periodically restated to US dollar equivalents, and the associated gain or loss is taken to the income statement. The exception is foreign exchange gains or losses on foreign currency denominated provisions for closure and rehabilitation at operating sites, which are capitalised in property, plant and equipment.

The principal non-US dollar currencies to which South32 is exposed are the Australian dollar, South African rand, Brazilian real and Colombian peso.

The following table shows the foreign currency risk arising from financial assets and liabilities, which are denominated in currencies other than the US dollar.

Net financial (liabilities)/assets – by currency of denomination	2014 US\$M	2013 US\$M	2012 US\$M
Australian dollars	(1,356)	(501)	(591)
South African rand	47	34	398
Brazilian real	4	146	246
Colombian peso	(36)	(39)	–
Other	10	12	(96)
Total	(1,331)	(348)	(43)

Based on South32's net financial assets and liabilities as at 30 June 2014, a weakening of the US dollar against non-US dollar currencies, with all other variables held constant, would (decrease)/increase profit after taxation and equity as follows:

Currency movement	2014 US\$M		2013 US\$M		2012 US\$M	
	Profit after taxation	Equity	Profit after taxation	Equity	Profit after taxation	Equity
1 cent movement in Australian dollar	(9)	(9)	(3)	(3)	(4)	(3)
0.2 rand movement in South African rand	(3)	1	(4)	–	(1)	7
0.05 real movement in Brazilian real	–	–	1	–	2	4
50 peso movement in Colombian peso	(1)	–	(1)	(1)	–	–

South32's financial asset and liability profile may not remain constant, and therefore these sensitivities should be used with care.

Transactional exposure in respect of non-US dollar expenditure and revenues

Certain operating and capital expenditure is incurred by some operations in currencies other than US dollars. To a lesser extent, certain sales revenue is earned in currencies other than US dollars, and certain exchange control restrictions may require that funds be maintained in currencies other than US dollars. These currency risks are managed as part of the portfolio risk management strategy. When required under this strategy South32 enters into forward exchange contracts.

The following table shows the fair value of forward exchange contracts outstanding to manage short-term foreign currency cash flows relating to operating activities:

Currency movement	2014 US\$M	2013 US\$M	2012 US\$M
Fair value of asset	–	1	5
Fair value of liability	–	–	–

Commodity price risk

The risk associated with commodity prices has been managed as part of BHP Billiton's portfolio risk management strategy. Contracts for the sale and physical delivery of commodities are executed whenever possible on a pricing basis intended to achieve a relevant index target. Where pricing terms deviate from the index, derivative commodity contracts may be used when available to return realised prices to the index. Contracts for the physical delivery of commodities are not typically financial instruments and are carried in the balance sheet at cost (typically at nil); they are therefore excluded from the fair value and sensitivity tables below. Accordingly, the financial instrument exposures set out in the tables below do not represent all of the commodity price risks managed according to BHP Billiton's objectives. Movements in the fair value of contracts included in the tables below are offset by movements in the fair value of the physical contracts, however only the former movement is recognised in South32's income statement prior to settlement.

Financial instruments with commodity price risk included in the following tables are those entered into for the following activities:

- economic hedging of prices realised on commodity contracts as described above;
- purchases and sales of physical contracts that can be cash-settled; and
- derivatives embedded in other supply contracts.

All such instruments are carried in the balance sheet at fair value.

Forward commodity and other derivative contracts

	2014		2013		2012	
	Fair value of asset US\$M	Fair value of liability US\$M	Fair value of asset US\$M	Fair value of liability US\$M	Fair value of asset US\$M	Fair value of liability US\$M
Aluminium	54	7	71	6	160	62
Lead, Silver and Zinc	-	2	-	-	7	-
Energy coal	-	1	-	1	-	1
Nickel	-	-	1	-	-	-
Total	54	10	72	7	167	63
Comprising:						
Current	13	4	28	-	73	43
Non-current	41	6	44	7	94	20

South32's exposure at 30 June 2014 to the impact of movements in commodity prices upon the financial instruments, other than those designated as embedded derivatives, is set out in the following table:

		2014		2013		2012	
		Net exposure receive/ (deliver) ^(a)	Impact on equity and profit after taxation of 10% increase in market price US\$M	Net exposure receive/ (deliver)	Impact on equity and profit after taxation of 10% increase in market price US\$M	Net exposure receive/ (deliver)	Impact on equity and profit after taxation of 10% increase in market price US\$M
Aluminium	Tonnes ('000s)	-	-	2	-	(73)	15
Lead	Tonnes ('000s)	-	-	(2)	-	(8)	2
Silver	Ounces (millions)	-	-	-	-	-	3
Nickel	Tonnes ('000s)	-	-	(1)	1	2	(4)

(a) Exposures on volumes are nil for 30 June 2014 as long and short positions are equal.

Provisionally priced commodity sales contracts

Not included in the above tables are provisionally priced sales volumes for which price finalisation, referenced to the relevant index, is outstanding at the reporting date. Provisional pricing mechanisms embedded within these sales arrangements have the character of a commodity derivative and are carried at fair value through profit and loss as part of trade receivables. South32's exposure at 30 June 2014 to the impact of movements in commodity prices upon provisionally invoiced sales volumes is set out in the following table:

		2014		2013		2012	
		Net exposure receive/ (deliver)	Impact on equity and profit after taxation of 10% increase in market price US\$M	Net exposure receive/ (deliver)	Impact on equity and profit after taxation of 10% increase in market price US\$M	Net exposure receive/ (deliver)	Impact on equity and profit after taxation of 10% increase in market price US\$M
Zinc	Tonnes ('000s)	(11)	2	(7)	1	-	-
Lead	Tonnes ('000s)	(29)	6	(59)	12	-	-
Silver	Ounces ('000s)	(3,426)	7	(7,788)	14	-	-
Nickel	Tonnes ('000s)	(1)	1	(2)	3	-	-
Coal	Tonnes ('000s)	-	-	-	-	-	-

Interest rate risk

During the Reporting Period, the majority of BHP Billiton's debt was raised under central borrowing programs, and BHP Billiton has funded its businesses through intercompany investments and loans. Interest rate risk for South32 has been managed as part of the portfolio risk management strategy of BHP Billiton's central treasury function.

Liquidity risk

South32's liquidity risk arises from the possibility that it may not be able to settle or meet its obligations as they fall due. This has been managed as part of BHP Billiton's centralised portfolio risk management strategy. Operational, capital and regulatory requirements are considered in the management of liquidity risk, in conjunction with short-term and long-term forecast information.

During the Reporting Period, BHP Billiton's portfolio risk management strategy has essentially had a strong credit profile, diversified funding sources and committed credit facilities which ensured that sufficient liquid funds were maintained by the central treasury function to meet its daily cash requirements. BHP Billiton's policy on counterparty credit exposure also ensures that only counterparties of a high credit standing are used for the investment of any excess cash.

Maturity profile of financial liabilities

The maturity profile of South32's financial liabilities, other than amounts owing to BHP Billiton, based on the contractual amounts and taking into account the derivatives related to debt, is as follows:

	Bank loans, debentures and other loans US\$M	Expected future interest payments US\$M	Other derivatives US\$M	Obligations under finance leases US\$M	Other financial liabilities US\$M	Total US\$M
2014						
Due for payment:						
In one year or less or on demand	32	7	4	81	1,241	1,365
In more than one year but not more than two years	271	14	1	81	53	420
In more than two years but not more than three years	5	17	1	81	–	104
In more than three years but not more than four years	5	19	1	80	–	105
In more than four years but not more than five years	4	20	1	90	–	115
In more than five years	180	70	2	1,447	2	1,701
Total due for payment	497	147	10	1,860	1,296	3,810
Carrying amount	497	–	10	803	1,296	2,606

	Bank loans, debentures and other loans US\$M	Expected future interest payments US\$M	Other derivatives US\$M	Obligations under finance leases US\$M	Other financial liabilities US\$M	Total US\$M
2013						
Due for payment:						
In one year or less or on demand	91	6	2	3	1,310	1,412
In more than one year but not more than two years	36	6	1	15	11	69
In more than two years but not more than three years	7	5	1	2	–	15
In more than three years but not more than four years	6	5	1	2	–	14
In more than four years but not more than five years	5	4	1	2	–	12
In more than five years	196	26	3	25	204	454
Total due for payment	341	52	9	49	1,525	1,976
Carrying amount	341	–	7	33	1,525	1,906

2012	Bank loans, debentures and other loans US\$M	Expected future interest payments US\$M	Other derivatives US\$M	Obligations under finance leases US\$M	Other financial liabilities US\$M	Total US\$M
Due for payment:						
In one year or less or on demand	208	25	44	5	1,581	1,863
In more than one year but not more than two years	29	22	12	4	17	84
In more than two years but not more than three years	7	21	1	3	–	32
In more than three years but not more than four years	7	20	1	3	–	31
In more than four years but not more than five years	6	18	5	28	–	57
In more than five years	223	48	–	19	231	521
Total due for payment	480	154	63	62	1,829	2,588
Carrying amount	480	–	63	38	1,829	2,410

The amounts presented in the tables above comprise the contractual undiscounted cash flows, and therefore will not always agree with the amounts presented in the balance sheet. South32 holds derivatives related to commodities and currencies that are classified as other financial assets when they are expected to generate cash inflows – refer to note 10 Other financial assets.

Credit risk

Credit risk arises from the non-performance by counterparties of their contractual financial obligations towards South32. Historically, BHP Billiton has maintained group-wide procedures covering the application for credit approvals, granting and renewal of counterparty limits and daily monitoring of exposures against these limits. As part of these processes, the financial viability of all counterparties is regularly monitored and assessed. The maximum exposure to credit risk is limited to the total carrying amount of relevant financial assets on the balance sheet as at the reporting date.

South32's credit exposures are categorised under the following headings:

Counterparties

South32 has conducted transactions with the following major types of counterparties:

- Receivables counterparties
Approximately 60 per cent of sales to South32's customers are made on open terms.
- Payment guarantee counterparties
Approximately half of sales to South32's customers occur via secured payment mechanisms.
- Derivative counterparties
Counterparties to derivative contracts consist of a diverse number of financial institutions and industrial counterparties in the relevant markets.

South32 has no significant concentration of credit risk with any single counterparty or group of counterparties.

Geographic

South32 trades in all major geographic regions. Countries in which South32 has a significant credit risk exposure include South Africa, Australia, the United States, Japan and China. Where appropriate, secured payment mechanisms and other risk mitigation instruments are used to protect revenues from credit risk losses.

Industry

In line with South32's asset portfolio, South32 sells into a diverse range of industries and customer sectors. This diversity means that South32 is not materially exposed to any individual industry or customer.

The following table shows South32's receivables at the reporting date that are exposed to credit risk and the ageing and impairment profile thereon:

2014	Receivables past due but not impaired					
	Gross amount US\$M	Receivables neither past due nor impaired US\$M	Less than 30 days US\$M	31 to 60 days US\$M	61 to 90 days US\$M	Over 90 days US\$M
Trade receivables	623	618	4	–	–	1
Trade receivables from BHP Billiton	869	869	–	–	–	–
Other receivables	466	392	10	1	2	61
Other receivables from BHP Billiton	1,074	1,074	–	–	–	–
Total	3,032	2,953	14	1	2	62

2013	Receivables past due but not impaired					
	Gross amount US\$M	Receivables neither past due nor impaired US\$M	Less than 30 days US\$M	31 to 60 days US\$M	61 to 90 days US\$M	Over 90 days US\$M
Trade receivables	749	746	2	–	–	1
Trade receivables from BHP Billiton	982	982	–	–	–	–
Other receivables	682	596	11	4	3	68
Other receivables from BHP Billiton	827	827	–	–	–	–
Total	3,240	3,151	13	4	3	69

2012	Receivables past due but not impaired					
	Gross amount US\$M	Receivables neither past due nor impaired US\$M	Less than 30 days US\$M	31 to 60 days US\$M	61 to 90 days US\$M	Over 90 days US\$M
Trade receivables	984	980	3	–	–	1
Trade receivables from BHP Billiton	890	890	–	–	–	–
Other receivables	943	814	43	2	2	82
Other receivables from BHP Billiton	2,663	2,663	–	–	–	–
Total	5,480	5,347	46	2	2	83

Receivables are deemed to be past due or impaired with reference to South32's normal terms and conditions of business. These terms and conditions are determined on a case-by-case basis with reference to the customer's credit quality and prevailing market conditions. Receivables that are classified as 'past due' in the above tables are those that have not been settled within the terms and conditions that have been agreed with that customer.

The credit quality of South32's customers is monitored on an ongoing basis and assessed for impairment where indicators of such impairment exist. The solvency of each debtor and their ability to repay the receivable is considered in assessing receivables for impairment. In certain circumstances, South32 may seek collateral as security for the receivable. Where receivables have been impaired, South32 actively seeks to recover the amounts in question and enforce compliance with credit terms.

Fair values

All financial assets and financial liabilities, other than derivatives, are initially recognised at the fair value of consideration paid or received, net of transaction costs as appropriate, and subsequently carried at fair value or amortised cost, as indicated in the tables below. Derivatives are initially recognised at fair value on the date the contract is entered into and are subsequently remeasured at their fair value.

The financial assets and liabilities are presented by class in the tables below at their carrying values, which generally approximate to the fair values.

Financial assets and liabilities

2014	Note	Loans and receivables US\$M	Available for sale securities US\$M	Held at fair value through profit or loss US\$M	Other financial assets and liabilities at amortised cost US\$M	Total US\$M
Financial assets						
Cash and cash equivalents	20	353	–	–	–	353
Trade and other receivables ^(a)	9	836	–	8	–	844
Trade receivables from BHP Billiton	9	869	–	–	–	869
Other derivative contracts	10	–	–	54	–	54
Interest bearing loans receivable	9	67	–	–	–	67
Interest bearing loans receivable from BHP Billiton	9	1,074	–	–	–	1,074
Shares – available for sale	10	–	317	–	–	317
Other investments – available for sale	10	–	144	–	–	144
Total financial assets		3,199	461	62	–	3,722
Non-financial assets						15,968
Total assets						19,690
Financial liabilities						
Trade and other payables ^(b)	14	–	–	3	1,359	1,362
Payables to BHP Billiton	14	–	–	–	28	28
Other derivative contracts	16	–	–	10	–	10
Unsecured bank loans	15	–	–	–	280	280
Finance leases	15	–	–	–	803	803
Unsecured other	15	–	–	–	217	217
Interest bearing liabilities payable to BHP Billiton	15	–	–	–	3,728	3,728
Total financial liabilities		–	–	13	6,415	6,428
Non-financial liabilities						3,442
Total liabilities						9,870

2013	Note	Loans and receivables US\$M	Available for sale securities US\$M	Held at fair value through profit or loss US\$M	Other financial assets and liabilities at amortised cost US\$M	Total US\$M
Financial assets						
Cash and cash equivalents	20	345	–	–	–	345
Trade and other receivables ^(a)	9	1,080	–	9	–	1,089
Receivables from BHP Billiton	9	982	–	–	–	982
Forward exchange contracts	10	–	–	1	–	1
Commodity contracts	10	–	–	19	–	19
Other derivative contracts	10	–	–	52	–	52
Interest bearing loans receivable	9	88	–	–	–	88
Interest bearing loans receivable from BHP Billiton	9	827	–	–	–	827
Shares – available for sale	10	–	395	–	–	395
Other investments – available for sale	10	–	137	–	–	137
Total financial assets		3,322	532	81	–	3,935
Non-financial assets						15,608
Total assets						19,543
Financial liabilities						
Trade and other payables ^(b)	14	–	–	–	1,491	1,491
Payables to BHP Billiton	14	–	–	–	10	10
Other derivative contracts	16	–	–	7	–	7
Unsecured bank loans	15	–	–	–	44	44
Secured bank and other loans	15	–	–	–	20	20
Finance leases	15	–	–	–	33	33
Unsecured other	15	–	–	–	277	277
Interest bearing liabilities payable to BHP Billiton	15	–	–	–	4,341	4,341
Total financial liabilities		–	–	7	6,216	6,223
Non-financial liabilities						3,200
Total liabilities						9,423

2012	Note	Loans and receivables US\$M	Available for sale securities US\$M	Held at fair value through profit or loss US\$M	Other financial assets and liabilities at amortised cost US\$M	Total US\$M
Financial assets						
Cash and cash equivalents	20	346	–	–	–	346
Trade and other receivables ^(a)	9	1,221	–	2	–	1,223
Receivables from BHP Billiton	9	890	–	–	–	890
Forward exchange contracts	10	–	–	5	–	5
Commodity contracts	10	–	–	100	–	100
Other derivative contracts	10	–	–	62	–	62
Interest bearing loans receivable	9	82	–	–	–	82
Interest bearing loans receivable from BHP Billiton	9	2,663	–	–	–	2,663
Shares – available for sale	10	–	493	–	–	493
Other investments – available for sale	10	–	145	–	–	145
Total financial assets		5,202	638	169	–	6,009
Non-financial assets						18,003
Total assets						24,012
Financial liabilities						
Trade and other payables ^(b)	14	–	–	–	1,964	1,964
Payables to BHP Billiton	14	–	–	–	13	13
Commodity contracts	16	–	–	53	–	53
Other derivative contracts	16	–	–	10	–	10
Unsecured bank overdrafts and short-term borrowings	15	–	–	–	19	19
Unsecured bank loans	15	–	–	–	73	73
Secured bank and other loans	15	–	–	–	40	40
Finance leases	15	–	–	–	38	38
Unsecured other	15	–	–	–	348	348
Interest bearing liabilities payable to BHP Billiton	15	–	–	–	4,071	4,071
Total financial liabilities		–	–	63	6,566	6,629
Non-financial liabilities						3,571
Total liabilities						10,200

(a) Excludes input taxes of US\$178 million (2013: US\$254 million; 2012: US\$623 million) included in other receivables. Refer to note 9 Trade and other receivables.

(b) Excludes input taxes of US\$5 million (2013: US\$103 million; 2012: US\$66 million) included in other payables. Refer to note 14 Trade and other payables.

Valuation hierarchy

The carrying amount of financial assets and liabilities measured at fair value is principally calculated with reference to quoted prices in active markets for identical assets or liabilities. Where no price information is available from a quoted market source, alternative market mechanisms or recent comparable transactions, fair value is estimated based on South32's views on relevant future prices, net of valuation allowances to accommodate liquidity, modelling and other risks implicit in such estimates. The inputs used in fair value calculations are determined by the relevant BHP Billiton Group function. BHP Billiton's Group Functions support the businesses and operate under a defined set of accountabilities authorised by the BHP Billiton Group Management Committee. Movements in the fair value of financial assets and liabilities may be recognised through the income statement or in other comprehensive income. The following table shows South32's financial assets and liabilities carried at fair value with reference to the nature of valuation inputs used:

2014	Level 1 ^(a) US\$M	Level 2 ^(b) US\$M	Level 3 ^(c) US\$M	Total US\$M
Financial assets and liabilities				
Trade and other receivables	–	8	–	8
Trade and other payables	–	(3)	–	(3)
Other derivative contracts	–	(4)	48	44
Investments – available for sale	–	144	317	461
Total	–	145	365	510

2013	Level 1 ^(a) US\$M	Level 2 ^(b) US\$M	Level 3 ^(c) US\$M	Total US\$M
Financial assets and liabilities				
Trade and other receivables	–	9	–	9
Forward exchange contracts	–	1	–	1
Commodity contracts	–	19	–	19
Other derivative contracts	–	–	45	45
Investments – available for sale	–	137	395	532
Total	–	166	440	606

2012	Level 1 ^(a) US\$M	Level 2 ^(b) US\$M	Level 3 ^(c) US\$M	Total US\$M
Financial assets and liabilities				
Trade and other receivables	–	2	–	2
Forward exchange contracts	–	5	–	5
Commodity contracts	–	47	–	47
Other derivative contracts	–	–	52	52
Investments – available for sale	–	145	493	638
Total	–	199	545	744

(a) Valuation is based on unadjusted quoted prices in active markets for identical financial assets and liabilities.

(b) Valuation is based on inputs (other than quoted prices included in Level 1) that are observable for the financial asset or liability, either directly (i.e. as unquoted prices) or indirectly (i.e. derived from prices).

(c) Valuation is based on inputs that are not based on observable market data.

Level 3 financial assets and liabilities

The following table shows the movements in South32's level 3 financial assets and liabilities:

	2014 US\$M	2013 US\$M	2012 US\$M
At the beginning of the financial year	440	545	487
Additions	3	–	–
Disposals	(38)	–	–
Realised gains recognised in the income statement ^(a)	–	–	3
Unrealised gains/(losses) recognised in the income statement ^(a)	1	(5)	60
Unrealised losses recognised in other comprehensive income ^(b)	(22)	(100)	(5)
Transfers	(19)	–	–
At the end of the financial year	365	440	545

(a) Realised and unrealised gains and losses recognised in the income statement are recorded in expenses – refer to note 5 Expenses.

(b) Unrealised gains and losses recognised in other comprehensive income are recorded in invested capital.

Sensitivity of Level 3 financial assets and liabilities

The carrying amount of financial assets and liabilities that are valued using inputs other than observable market data are calculated using appropriate valuation models, including discounted cash flow modelling, with inputs such as commodity prices, foreign exchange rates and inflation. The potential effect of using reasonably possible alternative assumptions in these models, based on a change in the most significant input by 10 per cent while holding all other variables constant, is shown in the following table. Significant inputs are assessed individually for each financial asset and liability.

	Carrying value US\$M	Profit after taxation		Equity	
		10% increase in input US\$M	10% decrease in input US\$M	10% increase in input US\$M	10% decrease in input US\$M
2014					
Financial assets and liabilities					
Other derivative contracts	48	22	(22)	22	(22)
Investments – available for sale	317	–	–	70	(38)
Total	365	22	(22)	92	(60)

	Carrying value US\$M	Profit after taxation		Equity	
		10% increase in input US\$M	10% decrease in input US\$M	10% increase in input US\$M	10% decrease in input US\$M
2013					
Financial assets and liabilities					
Other derivative contracts	45	(5)	6	(5)	6
Investments – available for sale	395	–	–	71	(67)
Total	440	(5)	6	66	(61)

	Carrying value US\$M	Profit after taxation		Equity	
		10% increase in input US\$M	10% decrease in input US\$M	10% increase in input US\$M	10% decrease in input US\$M
2012					
Financial assets and liabilities					
Other derivative contracts	52	(8)	10	(8)	10
Investments – available for sale	493	–	–	33	(46)
Total	545	(8)	10	25	(36)

Capital management

During the Reporting Period South32 has operated under BHP Billiton's Capital Management strategy. Capital is monitored using a gearing ratio, being the ratio of net debt to net debt plus net assets.

	2014 US\$M	2013 US\$M	2012 US\$M
Cash and cash equivalents	(353)	(345)	(346)
Current debt	47	434	204
Non-current debt	4,981	4,281	4,385
Net debt	4,675	4,370	4,243
Net assets	9,820	10,120	13,812
Gearing	32%	30%	24%

24 Related party balances and transactions

Subsidiaries

The percentage of ordinary shares held in significant subsidiaries is disclosed in note 21 Subsidiaries.

Joint operations

The percentage interest held in significant joint operations is disclosed in note 22 Interests in joint operations

Key management personnel

Throughout the Reporting Period, South32 did not have its own key management personnel. These were represented by members of BHP Billiton's key management personnel and it is therefore not meaningful to disclose these balances or transactions.

Balances and transactions with related parties

Outstanding balances with related parties	BHP Billiton			Joint Ventures		
	2014 US\$M	2013 US\$M	2012 US\$M	2014 US\$M	2013 US\$M	2012 US\$M
Trade amounts owing to related parties ^(a)	28	10	13	14	24	5
Other amounts owing to related parties ^(b)	3,728	4,341	4,071	–	–	–
Trade amounts owing from related parties ^(a)	869	982	890	15	34	101
Other amounts owing from related parties ^(b)	1,074	827	2,663	92	66	–

Transactions with related parties	BHP Billiton			Joint Ventures		
	2014 US\$M	2013 US\$M	2012 US\$M	2014 US\$M	2013 US\$M	2012 US\$M
Sales of goods/services	–	5	13	257	260	269
Purchase of goods/services	264	341	122	80	293	48
Interest income	25	102	118	–	–	–
Interest expense	115	108	76	–	–	–
Dividends paid ^(c)	505	2,296	79	–	–	–
Dividends received ^(d)	11	12	20	–	–	–
Loans made to related parties	861	(2,106)	(1,408)	(27)	(66)	–
Equity transactions with BHP Billiton	133	60	135	–	–	–

(a) Trade amounts due to and from BHP Billiton and its subsidiaries under business operations are unsecured, interest-free and intended to be settled in the ordinary course of business.

(b) Loans due to and from BHP Billiton and its subsidiaries represent group funding arrangements managed through a centralised treasury and cash management function which will be settled at the date of Demerger.

(c) Dividends paid represent payments made by a South32 entity to a BHP Billiton entity. These dividend payments will not occur after Demerger.

(d) Dividends received represent receipts by a South32 entity from a BHP Billiton entity. These dividend receipts will not occur after Demerger.

Terms and conditions

Sales to and purchases from related parties of goods and services are made in arm's length transactions at normal market prices and on normal commercial terms.

Outstanding balances at year-end are unsecured.

Other amounts owing from related parties represent secured loans made to joint ventures under co-funding arrangements. Such loans are made on an arm's length basis with interest charged at market rates and are due to be repaid between 31 July 2014 and 31 August 2031.

No guarantees are provided or received for any related party receivables or payables.

No provision for doubtful debts has been recognised in relation to any outstanding balances and no expense has been recognised in respect of bad or doubtful debts due from related parties.

Transactions with key management personnel

During the financial year, there were no purchases from South32 (2013: US\$ nil; 2012 US\$ nil).

Loans with key management personnel

There are no loans (2013: US\$ nil; 2012: US\$ nil) with key management personnel.

Transactions with personally related entities

A number of Directors of South32 hold or have held positions in other companies, where it is considered they control or significantly influence the financial or operating policies of those entities. There have been no transactions with those entities and no amounts were owed by South32 to personally related entities (2013: US\$ nil; 2012: US\$ nil).

25 Pension and other post-retirement obligations

South32 operates the following pension and post-retirement medical schemes:

Defined contribution pension schemes and multi-employer pension schemes

South32 contributed US\$115 million (2013: US\$124 million; 2012: US\$87 million) to defined contribution plans and multi-employer defined contribution plans. These contributions are expensed as incurred.

Defined benefit pension schemes

South32 has closed all defined benefit schemes to new entrants. Defined benefit pension schemes remain operating for existing members in South Africa and Brazil and, as part of BHP Billiton's pension schemes, in Australia. Full actuarial valuations are prepared and updated annually to 30 June by local actuaries for all schemes. The Projected Unit Credit valuation method is used. South32 operates final salary schemes that provide final salary benefits only, non-salary related schemes that provide flat dollar benefits and mixed benefit schemes that consist of a final salary defined benefit portion and a defined contribution portion.

Defined benefit post-retirement medical schemes

South32 operates a number of post-retirement medical schemes in South Africa. Full actuarial valuations are prepared by local actuaries for all schemes. All of the post-retirement medical schemes in South32 are unfunded.

South32's defined benefit pension schemes and post-retirement medical schemes expose South32 to a number of risks:

Risk	Description
Volatility in asset values	South32 is exposed to changes in the value of assets held in funded pension schemes to meet future benefit payments.
Uncertainty in benefit payments	The cost to South32 of meeting future benefit obligations will depend on the value of the benefits paid in the future. To the extent these payments are dependent on future experience, there is some uncertainty. Some of the schemes' benefit obligations are linked to inflation or to salaries, and some schemes provide benefits that are paid for the life of the member. If future experience varies from the assumptions used to value these obligations, the cost of meeting the obligations will vary.
Uncertainty in future funding requirements	Movement in the value of benefit obligations and scheme assets will impact the contributions that South32 will be required to make to the schemes in the future. In many cases, pension schemes are managed under trust, and South32 does not have full control over the rate of funding or investment policy for scheme assets. In addition, South32 is exposed to changes in the regulations applicable to benefit schemes.

Recognising this, South32 has adopted an approach of moving away from providing defined benefit pensions. The majority of South32 sponsored defined benefit pension schemes have been closed to new entrants for many years. Existing benefit schemes, and the terms of employee participation in these schemes, are reviewed on a regular basis.

South32 follows a coordinated strategy for the funding and investment of its defined benefit pension schemes (subject to meeting all local requirements). South32's aim is for the value of defined benefit scheme assets to be maintained at close to the value of the corresponding benefit obligations, allowing for some short term volatility.

The following tables set out details of South32's defined benefit pension and post-retirement medical schemes.

Balance sheet disclosures

The amounts recognised in the combined balance sheet are as follows:

	Defined benefit pension schemes			Post-retirement medical schemes		
	2014 US\$M	2013 US\$M	2012 US\$M	2014 US\$M	2013 US\$M	2012 US\$M
Present value of funded defined benefit obligation	287	314	351	-	-	-
Present value of unfunded defined benefit obligation	-	-	-	163	159	171
Fair value of defined benefit scheme assets	(317)	(335)	(348)	-	-	-
Scheme (surplus)/deficit	(30)	(21)	3	163	159	171
Unrecognised surplus	-	-	-	-	-	-
Unrecognised past service credits	-	-	-	-	-	-
Net (asset)/liability recognised in the combined balance sheet	(30)	(21)	3	163	159	171

South32 has no legal obligation to settle these liabilities with any immediate contributions or additional one-off contributions. South32 intends to continue to contribute to each defined benefit pension and post-retirement medical scheme in accordance with the latest recommendations of each scheme actuary.

Income statement disclosures

The amounts recognised in the combined income statement are as follows:

	Defined benefit pension schemes			Post-retirement medical schemes		
	2014 US\$M	2013 US\$M	2012 US\$M	2014 US\$M	2013 US\$M	2012 US\$M
Current service cost	5	7	7	-	-	-
Net interest expense/(income) on net defined benefit liability/(asset)	(2)	(3)	(3)	13	15	15
Total expense	3	4	4	13	15	15
- Recognised in employee benefits expense	5	7	7	-	-	-
- Recognised in net finance costs	(2)	(3)	(3)	13	15	15

Statement of comprehensive income (SOI) disclosures

The amounts recognised in the combined statement of comprehensive income are as follows:

	Defined benefit pension schemes			Post-retirement medical schemes		
	2014 US\$M	2013 US\$M	2012 US\$M	2014 US\$M	2013 US\$M	2012 US\$M
Actuarial (gains)/losses	(6)	(12)	21	8	10	4
Limit on net assets and other adjustments	-	-	(13)	-	-	-
Total amount recognised in the SOI	(6)	(12)	8	8	10	4
Total cumulative amount recognised in the SOI^(a)	(10)	(4)	8	22	14	4

(a) Cumulative amounts are calculated from the transition to IFRS on 1 July 2004.

The change in the net defined benefit liability is as follows:

	Defined benefit pension schemes			Post-retirement medical schemes		
	2014 US\$M	2013 US\$M	2012 US\$M	2014 US\$M	2013 US\$M	2012 US\$M
Net defined benefit (asset)/liability at the beginning of the financial year	(21)	3	-	159	171	200
Amount recognised in the income statement	3	4	4	13	15	15
Remeasurement (gain)/loss recognised in other comprehensive income	(6)	(12)	8	8	10	4
Disbursements and settlements paid directly by employer	-	-	-	(8)	(9)	(9)
Employer contributions	(6)	(21)	(10)	-	-	-
Foreign exchange losses/(gains)	2	4	1	(9)	(28)	(39)
Other adjustments	(2)	1	-	-	-	-
Net defined benefit (asset)/liability at the end of the financial year	(30)	(21)	3	163	159	171

The changes in the present value of defined benefit obligations are as follows:

	Defined benefit pension schemes			Post-retirement medical schemes		
	2014 US\$M	2013 US\$M	2012 US\$M	2014 US\$M	2013 US\$M	2012 US\$M
Defined benefit (asset)/obligation at the beginning of the financial year	(21)	3	–	159	171	200
Current service cost	5	7	7	–	–	–
Interest cost	(2)	(3)	(3)	13	15	15
Contributions by scheme participants	(6)	(21)	(10)	(8)	(9)	(9)
Actuarial (gains)/losses on benefit obligation	(6)	(12)	8	8	10	4
Foreign exchange losses/(gains)	2	4	1	(9)	(28)	(39)
Other adjustments	(2)	1	–	–	–	–
Defined benefit (asset)/obligation at the end of the financial year	(30)	(21)	3	163	159	171

The change in the fair value of scheme assets for defined benefit pension schemes is as follows:

	Defined benefit pension schemes		
	2014 US\$M	2013 US\$M	2012 US\$M
Fair value of scheme assets at the beginning of the financial year	335	348	396
Interest income on scheme assets	24	26	28
Return on scheme assets greater than the discount rate	(13)	22	11
Employer contributions	6	21	10
Contributions by scheme participants	–	–	1
Benefits paid to participants	(23)	(35)	(32)
Foreign exchange losses	(9)	(47)	(66)
Settlements	(3)	–	–
Fair value of scheme assets at the end of the financial year	317	335	348

The fair values of defined benefit pension scheme assets segregated by major asset class are as follows:

Asset class	Fair value		
	2014 US\$M	2013 US\$M	2012 US\$M
Bonds ^(a)	104	117	108
Equities	42	47	54
Property ^(b)	5	6	8
Cash and net current assets	31	15	22
Insured annuities	135	146	155
Other ^(c)	–	4	1
Total	317	335	348

(a) The bonds asset class as at 30 June 2014 includes Fixed Interest Government Bonds of US\$50 million, and Index linked Government Bonds of US\$54 million.

(b) Property is the only asset class that does not have a quoted market price in an active market.

(c) Scheme assets classified as 'Other' as at 30 June 2014 primarily comprise private equity investments and alternate assets in Australia.

The fair value of scheme assets includes no amounts relating to any of South32's own financial instruments or any of the property occupied by or other assets used by South32.

Scheme assets are invested in a diversified range of asset classes, predominantly comprising bonds and insured annuities in South Africa. In some locations, scheme trustees and other bodies have legal responsibility for the investment of scheme assets, and decisions on investment strategy are taken in consultation with South32.

South32 monitors its exposure to changes in equity markets, interest rates and inflation, and measures its balance sheet pension risk using a risk-based approach. Asset-liability studies are carried out periodically for the major pension schemes and the suitability of investment strategies for all defined benefit pension schemes are also reviewed periodically.

South32's aim is to progressively shift defined benefit pension scheme assets towards investments that match the anticipated profile of the benefit obligations, as funding levels improve, and as benefit obligations mature. Over time, this is expected to result in a further reduction in the total exposure of pension scheme assets to equity markets. For pension schemes that pay lifetime benefits, South32 may consider and support the purchase of annuities to back these benefit obligations if it is commercially sensible to do so.

Weighted average maturity profile of defined benefit obligation

	Defined benefit pension schemes			Post-retirement medical schemes		
	2014	2013	2012	2014	2013	2012
Weighted average duration of defined benefit obligation (years)	4.1	4.7	6.0	14.8	13.9	13.6

Actuarial assumptions

The principal actuarial assumptions at the reporting date (expressed as weighted averages) for defined benefit pension schemes are as follows:

	Australia			Brazil			South Africa		
	2014	2013	2012	2014	2013	2012	2014	2013	2012
	%	%	%	%	%	%	%	%	%
Discount rate	3.3	3.1	2.7	11.7	10.4	9.2	9.4	8.6	8.7
Future salary increases	3.9	4.0	4.3	7.5	7.3	6.6	9.0	8.3	8.0

The principal actuarial assumptions at the reporting date (expressed as weighted averages) for post-retirement medical schemes are as follows:

	South Africa		
	2014	2013	2012
	%	%	%
Discount rate	9.2	8.7	9.0
Medical cost trend rate (ultimate)	8.7	7.9	8.0

Assumptions regarding future mortality can be material depending upon the size and nature of the plan liabilities. Post-retirement mortality assumptions in South Africa are based on standard post-retirement mortality tables.

These tables imply the following expected future lifetimes (in years) for employees aged 65 as at 30 June 2014: South African males 19.2 (2013: 19.0; 2012: 18.8), South African females 23.6 (2013: 23.4; 2012: 23.3).

Estimated contributions for the defined benefit pension and post-retirement medical schemes are as follows:

	Defined benefit pension schemes US\$M	Post-retirement medical schemes US\$M
Estimated employer contributions for the year ending 30 June 2015	5	-
Estimated benefits paid to participants directly by employer for the year ending 30 June 2015	-	8

Sensitivity to assumptions

South32's defined benefit obligation at 30 June 2014 has been determined using actuarial calculations that require assumptions about future events. The estimated sensitivity of the defined benefit obligation to each significant assumption shown below has been determined at an individual scheme level if each assumption were changed in isolation. In practice, the schemes are subject to multiple external experience items which may vary the defined benefit obligation over time. The methods and assumptions used in preparing these sensitivity results remain consistent with those used in previous Reporting Periods.

The estimated effects of variations in the principal actuarial assumptions on South32's defined benefit obligation at 30 June 2014 are as follows:

	Increase/(decrease) in defined benefit obligation	
	Defined benefit pension schemes US\$M	Post-retirement medical schemes US\$M
Discount rate		
Increase of 1%	(11)	(20)
Decrease of 1%	15	25
Future salary increases		
Increase of 1%	5	n/a
Decrease of 1%	(4)	n/a
Mortality		
Increase in the life expectancy at age 65 of 1 year	1	7
Decrease in the life expectancy at age 65 of 1 year	(1)	(7)
Medical cost trend rate (initial and ultimate)		
Increase of 1%	n/a	25
Decrease of 1%	n/a	(20)

26 Subsequent events

30 June 2014

Proposed Demerger of assets

In contemplation of the proposed Demerger, BHP Billiton and Anglo American agreed to make certain changes to the agreement which governs their interests in the Manganese Business. South32 will acquire BHP Billiton's interest and following implementation of the Demerger, South32 will manage and own 60 per cent of the Manganese Business with Anglo American owning the remaining 40 per cent.

Following receipt on 2 March 2015 of the last of the approvals required for the agreement, the changes result in South32 and Anglo American agreeing to share joint control of the Manganese Business. With effect from this date South32 will discontinue consolidation of the Manganese Business and account for its 60 per cent interest as an equity accounted joint venture. South32 will therefore derecognise the existing carrying amounts of all assets, liabilities and the non-controlling interest in the Manganese Business attributed to Anglo American and initially record its retained 60 per cent interest at fair value. The remeasurement at fair value gives rise to a gain of approximately US\$2 billion. There are no tax consequences arising from the remeasurement of the Manganese Business.

Following the move to equity accounting, South32 received a dividend from Australia Manganese that decreased the carrying value of the investment in the Manganese Business by US\$342 million.

Repeal of Minerals Resource Rent Tax (MRRT)

On 2 September 2014, legislation to repeal the MRRT in Australia received the support of both Houses of Parliament. The MRRT continued to apply until 30 September 2014. At 30 June 2014, South32 carried an MRRT deferred tax asset (net of income tax consequences) of US\$66 million. An income tax charge of US\$111 million was recognised in the first half of the 2015 financial year due to the derecognition of deferred tax assets (as of the date of repeal of the legislation) relating to the MRRT.

Other than the matters outlined above, no matters or circumstances have arisen since the end of the financial year that have significantly affected, or may significantly affect, the operations, results of operations or state of affairs of South32 in subsequent accounting periods.

1.7 INDEPENDENT AUDITOR REPORT



Independent Auditor Report of KPMG (“KPMG Australia”) and KPMG Inc (“KPMG South Africa”) to the Directors of South32 Limited

We have audited the accompanying historical combined financial information of the South32 Limited Group (as defined in this Document, the “Group”), being special purpose financial information as at and for the years ended 30 June 2012, 30 June 2013 and 30 June 2014 prepared for the purpose of the Group’s listing on the Johannesburg Stock Exchange (“JSE”) and admission to the Official List of the Financial Conduct Authority (“FCA”) of the United Kingdom. The historical combined financial information comprises, for each of the years described above: the combined balance sheet and combined statement of invested capital as at the year end; the combined income statement, combined statement of comprehensive income and combined cash flow statement for the year then ended; and notes comprising a summary of significant accounting policies and other explanatory information. The historical combined financial information has been prepared by the Directors using the basis of preparation set out in Note 1 to the historical combined financial information and in compliance with the respective listing requirements of the JSE and of the FCA.

Directors’ responsibility for the historical combined financial information

The Directors of the Group are responsible for the preparation and fair presentation of the historical combined financial information in accordance with the basis of preparation described in Note 1 to the historical combined financial information and the respective listing requirements of the JSE and of the FCA. The Directors’ responsibility also includes determining the acceptability of the basis of preparation in the circumstances and for such internal controls as the Directors determine are necessary to enable the preparation and presentation of the historical combined financial information that is free from material misstatement, whether due to fraud or error.

Auditor’s responsibility

Our responsibility is to express an audit opinion on the historical combined financial information based on our audit.

- KPMG Australia conducted an audit of the historical combined financial information in accordance with Australian Auditing Standards and International Standards on Auditing (UK and Ireland).
- KPMG South Africa conducted an audit of the historical combined financial information in accordance with International Standards on Auditing.

These standards require that we comply with relevant ethical requirements and plan and perform procedures to obtain reasonable assurance about whether the historical combined financial information is free from material misstatement.

An audit involves performing procedures to obtain audit evidence about the amounts and disclosures in the historical combined financial information. The procedures selected depend on our judgement, including the assessment of the risks of material misstatement of the historical combined financial information, whether due to fraud or error. In making those risk assessments, we consider internal control relevant to the preparation and fair presentation of the historical combined financial information in order to design audit procedures that are appropriate in the circumstances, but not for the purpose of expressing an opinion on the effectiveness of internal controls.

An audit also includes evaluating the appropriateness of accounting policies used and the reasonableness of accounting estimates, if any, made by management, as well as evaluating the overall presentation of the historical combined financial information.

We believe that the evidence we have obtained is sufficient and appropriate to provide a basis for our audit opinion.

KPMG, an Australian partnership, and KPMG Inc, a South African company incorporated under the South African Companies Act, are member firms of the KPMG network of independent member firms affiliated with KPMG International Cooperative (“KPMG International”), a Swiss entity.

KPMG Australia’s liability limited by a scheme approved under Professional Standards Legislation

KPMG Inc is a Registered Auditor, in public practice, in terms of the Auditing Profession Act, 26 of 2005.

Registration number 1999/021543/21

KPMG Inc’s Policy Board:

Chief Executive: RM Kgosana
Executive Directors: T Fubu, A Hari, E Magondo, JS McIntosh, CAT Smit, D van Heerden
Other Directors: DC Duffield, LP Fourie, N Fubu, TH Hoole, A Jaffer, M Letsitsi, A Masemola, M Mokgabudi, Y Suleman (Chairman of the Board), A Thunström

KPMG Inc’s principal place of business is at KPMG Crescent, 85 Empire Road, Parktown, where a list of the directors’ names is available for inspection.



Independence

In conducting our audit, KPMG Australia has complied with the independence requirements of the Australian Accounting Professional and Ethical Standards Board.

Audit opinion

In our opinion, the historical combined financial information of the Group as at and for the years ended 30 June 2012, 30 June 2013 and 30 June 2014 is presented fairly, in all material respects, in accordance with the basis of preparation described in Note 1 of the historical combined financial information and the respective listing requirements of the JSE and of the FCA.

Basis of preparation

Without modifying our audit opinion, we draw attention to Note 1 to the historical combined financial information which describes the basis of preparation of the historical combined financial information, including the approach to and the purpose for preparing the information and that the preparation involves complex allocations of certain items. Consequently, the historical combined financial information may not necessarily be indicative of the financial performance that would have been achieved if the South32 Group had operated as an independent group, nor may it be indicative of the results of operations of the South32 Group for any future period.

The historical combined financial information has been prepared solely for the purpose of fulfilling the Directors' financial reporting responsibilities in order to comply with the respective listing requirements of the JSE and of the FCA. As a result, the historical combined financial information may not be suitable for another purpose.

Declaration for the purposes of the Prospectus Directive Regulation as required by the FCA

This report is required by paragraph 20.1 of Annex I of the Prospectus Directive Regulation and is given for the purpose of complying with that paragraph and for no other purpose. For the purposes of Prospectus Rule 5.5.3R (2)(f) we are responsible for this report as part of the prospectus and declare that we have taken all reasonable care to ensure that the information contained in this report is, to the best of our knowledge, in accordance with the facts and contains no omission likely to affect its import. This declaration is included in the prospectus in compliance with paragraph 1.2 of Annex I of the Prospectus Directive Regulation.



KPMG

Chris Sargent
Partner

Melbourne, Australia
16 March 2015

KPMG Inc.
Per Jacques Erasmus
Chartered Accountant (SA), Registered Auditor, Director

Johannesburg, South Africa
16 March 2015

KPMG, an Australian partnership, and KPMG Inc, a South African company incorporated under the South African Companies Act, are member firms of the KPMG network of independent member firms affiliated with KPMG International Cooperative ("KPMG International"), a Swiss entity.

KPMG Australia's liability limited by a scheme approved under Professional Standards Legislation

KPMG Inc is a Registered Auditor, in public practice, in terms of the Auditing Profession Act, 26 of 2005.

Registration number 1999/021543/21

KPMG Inc's Policy Board:

Chief Executive: RM Kgosana
Executive Directors: T Fubu, A Hari, E Magondo, JS McIntosh, CAT Smit, D van Heerden
Other Directors: DC Duffield, LP Fourie, N Fubu, TH Hoole, A Jaffer, M Letsitsi, A Masemola, M Mokgabudi, Y Suleman (Chairman of the Board), A Thunström

KPMG Inc's principal place of business is at KPMG Crescent, 85 Empire Road, Parktown, where a list of the directors' names is available for inspection.

ANNEXURE 2

HALF YEAR HISTORICAL COMBINED FINANCIAL INFORMATION FOR THE HALF YEAR PERIODS ENDED 31 DECEMBER 2014 AND 31 DECEMBER 2013 FOR SOUTH32

2.1 COMBINED INCOME STATEMENT

	Notes	H1 FY2015 US\$M	H1 FY2014 US\$M
Revenue			
Group production	2	4,636	4,572
Third party products	2	404	776
Revenue	2	5,040	5,348
Other income	4	521	105
Expenses excluding net finance costs		(4,313)	(4,906)
Share of operating profit of equity accounted investments		3	7
Profit from operations		1,251	554
Comprising:			
Group production		1,221	526
Third party products		30	28
Financial income	5	44	28
Financial expenses	5	(81)	(136)
Net finance costs	5	(37)	(108)
Profit before taxation		1,214	446
Income tax expense		(380)	(113)
Royalty-related taxation (net of income tax benefit)		(96)	25
Total taxation expense	6	(476)	(88)
Profit after taxation		738	358
Attributable to non-controlling interests		50	41
Attributable to members of South32		688	317
Basic earnings per ordinary share (US cents)	7	12.92	5.95
Diluted earnings per ordinary share (US cents)	7	12.88	5.94

The accompanying notes form part of the historical combined financial information.

Certain administration costs, net finance costs, tax and pension amounts of South32 reflect the management and capital structure of South32 prior to the Demerger. Accordingly these amounts, together with respective earnings per share figure, may not be comparable with actual amounts that would have occurred had the Demerger been in effect during the periods presented. Refer to Section 1.6 ('Basis of preparation of historical combined financial information') in Annexure 1 for details of assumptions made in preparing the historical combined financial information.

2.2 COMBINED STATEMENT OF COMPREHENSIVE INCOME

	H1 FY2015 US\$M	H1 FY2014 US\$M
Profit after taxation	738	358
Other comprehensive income		
Items that may be reclassified subsequently to the income statement:		
Available for sale investments:		
Net valuation losses taken to equity	(18)	(7)
Net valuation gains transferred to the income statement	-	(2)
Tax recognised within other comprehensive income	1	-
Total items that may be reclassified subsequently to the income statement	(17)	(9)
Items that will not be reclassified to the income statement:		
Actuarial (losses)/gains on pension and medical schemes	(9)	12
Tax recognised within other comprehensive income	3	(3)
Total items that will not be reclassified to the income statement	(6)	9
Total other comprehensive loss	(23)	-
Total comprehensive income	715	358
Attributable to non-controlling interests	55	41
Attributable to members of South32	660	317

The accompanying notes form part of the historical combined financial information.

2.3 COMBINED BALANCE SHEET

	Note	31 December 2014 US\$M	31 December 2013 US\$M
ASSETS			
Current assets			
Cash and cash equivalents		459	196
Trade and other receivables		1,098	1,320
Receivables from BHP Billiton		9,508	1,764
Other financial assets		15	13
Inventories		1,406	1,626
Current tax assets		107	305
Other		37	137
Total current assets		12,630	5,361
Non-current assets			
Trade and other receivables		185	382
Other financial assets		508	501
Investments accounted for using the equity method		13	7
Inventories		60	78
Property, plant and equipment		12,220	11,990
Intangible assets		290	343
Deferred tax assets		801	970
Other		16	51
Total non-current assets		14,093	14,322
Total assets		26,723	19,683
LIABILITIES			
Current liabilities			
Trade and other payables		1,232	1,593
Payables to BHP Billiton		41	136
Interest bearing liabilities		136	69
Interest bearing liabilities payable to BHP Billiton		-	78
Other financial liabilities		6	7
Current tax payable		104	108
Provisions		413	533
Deferred income		4	77
Total current liabilities		1,936	2,601
Non-current liabilities			
Trade and other payables		34	258
Interest bearing liabilities		877	484
Interest bearing liabilities payable to BHP Billiton		3,728	3,730
Other financial liabilities		18	6
Deferred tax liabilities		569	533
Provisions		2,010	1,779
Deferred income		4	3
Total non-current liabilities		7,240	6,793
Total liabilities		9,176	9,394
Net assets		17,547	10,289
INVESTED CAPITAL			
Invested capital attributable to members of South32	8	16,710	9,396
Invested capital attributable to non-controlling interests		837	893
Total invested capital		17,547	10,289

The accompanying notes form part of the historical combined financial information.

2.4 COMBINED CASH FLOW STATEMENT

	Note	H1 FY2015 US\$M	H1 FY2014 US\$M
Operating activities			
Profit before taxation		1,214	446
Adjustments for:			
Depreciation and amortisation expense		506	466
Net gain on sale of non-current assets		(1)	–
Net finance costs		37	108
Share of operating profit of equity accounted investments		(3)	(7)
Other		(327)	(11)
Changes in assets and liabilities:			
Trade and other receivables		93	(254)
Inventories		(4)	(106)
Trade and other payables		(193)	130
Net other financial assets and liabilities		(10)	52
Provisions and other liabilities		(181)	(43)
Cash generated from operations		1,131	781
Dividends received		368	18
Interest received		25	92
Interest paid		(141)	(147)
Income tax refunded		–	3
Income tax paid		(134)	(254)
Net operating cash flows		1,249	493
Investing activities			
Purchases of property, plant and equipment		(411)	(394)
Exploration expenditure		(13)	(14)
Exploration expenditure expensed and included in operating cash flows		9	11
Purchase of intangibles		–	(1)
Investment in financial assets		(13)	(12)
Cash outflows from investing activities		(428)	(410)
Proceeds from sale of property, plant and equipment		6	11
Proceeds from financial assets		7	46
Net investing cash flows		(415)	(353)
Financing activities			
Proceeds from interest bearing liabilities		7	235
Repayment of interest bearing liabilities		(103)	(463)
Proceeds from issue of shares	8	8,000	–
Deposit with BHP Billiton		(7,565)	–
Other movements in invested capital		(327)	298
Dividends paid		(661)	(343)
Dividends paid to non-controlling interests		(85)	(52)
Net financing cash flows		(734)	(325)
Net increase/(decrease) in cash and cash equivalents		100	(185)
Cash and cash equivalents, net of overdrafts, at the beginning of the period		353	345
Foreign currency exchange rate changes on cash and cash equivalents		(4)	(2)
Cash and cash equivalents, net of overdrafts, at the end of the period		449	158

The accompanying notes form part of the historical combined financial information.

2.5 COMBINED STATEMENT OF CHANGES IN INVESTED CAPITAL

	Note	H1 FY2015 US\$M	H1 FY2014 US\$M
Invested capital attributable to members of South32			
Balance as at 1 July		8,953	9,213
Profit for the period		688	317
Other comprehensive income		(28)	-
Dividends paid		(661)	(343)
Equity transactions with BHP Billiton	8	7,758	209
Balance as at 31 December		16,710	9,396
Invested capital attributable to non-controlling interests			
Balance as at 1 July		867	907
Profit for the period attributable to non-controlling interests		50	41
Other comprehensive income		5	-
Distributions paid to non-controlling interests		(85)	(52)
Equity contributed		-	(3)
Balance as at 31 December		837	893

The accompanying notes form part of the historical combined financial information.

2.6 NOTES TO THE HALF YEAR HISTORICAL COMBINED FINANCIAL INFORMATION

1 Accounting policies

The historical combined financial information for the half year ended 31 December 2014 and the comparative period ended 31 December 2013 ("Half Year Reporting Period") is unaudited and has been prepared in accordance with IAS 34 'Interim Financial Reporting' as issued by the International Accounting Standards Board (**IASB**) in conjunction with the basis of preparation contained in Annexure 1. The comparative balance sheets as at 30 June 2014 and 30 June 2013 as required by IAS 34 have been included as part of the annual historical combined financial information as set out in Annexure 1.

The directors are responsible for the preparation of the historical combined financial information and believe that the basis of preparation fairly presents South32's historical financial information in the circumstances set out in Annexure 1 and below.

The half year historical combined financial information is prepared in accordance with the requirements of the SAICA Financial Reporting Guides as issued by the Accounting Practices Committee and Financial Reporting Pronouncements as issued by the Financial Reporting Standards Council.

The historical financial information has been extracted from the consolidation schedules which supported the unaudited financial statements of the BHP Billiton Group for the Half Year Reporting Period.

The half year historical combined financial information represents a "combined condensed set of historical financial information". Accordingly, they do not include all of the information required for a full annual report and are to be read in conjunction with the annual historical combined financial information contained within Annexure 1.

The half year historical combined financial information has been prepared on the basis of accounting policies and methods of computation consistent with those applied in the annual historical combined financial information contained within Annexure 1, and with those anticipated to be applied by South32, with the exception of the following new accounting standards and interpretations which became effective from 1 July 2014:

- Amendments to IAS 32 'Financial Instruments: Presentation' clarify the criteria for offsetting financial assets and liabilities.
- IFRIC 21 'Levies' confirms that a liability to pay a levy is only recognised when the activity that triggers the payment occurs.

Rounding of amounts

Amounts in this half year historical combined financial information have, unless otherwise indicated, been rounded to the nearest million dollars.

Comparatives

Where applicable, comparatives have been restated to disclose them on the same basis as current period figures.

2 Segment reporting

Business segments

South32 operates the Businesses set out below. The reporting of financial information by Business reflects the proposed structure that will be used by South32's management to assess the performance of South32.

Reportable segment	Principal activities
Worsley Alumina	Integrated bauxite mine and alumina refinery in Western Australia
South Africa Aluminium	Aluminium smelter at Richards Bay
Mozal Aluminium	Aluminium smelter near Maputo in Mozambique
Brazil Aluminium	Alumina refinery and aluminium smelter in Brazil
South Africa Energy Coal	Open-cut and underground energy coal mines and processing operations in South Africa
Illawarra Metallurgical Coal	Underground metallurgical coal mines in southern New South Wales
Australia Manganese	Producer of manganese ore in the Northern Territory and manganese alloys in Tasmania
South Africa Manganese	Integrated producer of manganese ore and alloy in South Africa
Cerro Matoso	Integrated laterite ferronickel mining and smelting complex in northern Colombia
Cannington	Silver, lead and zinc mine located in northwest Queensland

All South32 Businesses are operated or jointly operated by South32 except Alumar (which forms part of Brazil Aluminium), which is operated by Alcoa.

Group and unallocated items represent Group centre functions and consolidation adjustments. Exploration and technology activities are recognised within relevant segments.

It is South32's policy that inter-segment sales are made on a commercial basis.

US\$M	Worsley Alumina	South Africa Aluminium	Mozal Aluminium	Brazil Aluminium	South Africa Energy Coal	Illawarra Metallurgical Coal	Australia Manganese	South Africa Manganese	Cerro Matoso	Cannington	Group and unallocated items / eliminations	Total South32
Half year ended 31 December 2014												
Revenue												
Group Production	319	823	340	268	683	425	566	386	340	486	-	4,636
Third party products ^(a)	-	-	-	-	-	-	-	-	-	-	404	404
Inter-segment revenue	332	-	-	-	-	-	-	-	-	-	(332)	-
Total revenue	651	823	340	268	683	425	566	386	340	486	72	5,040
Underlying EBITDA^(b)	143	201	88	140	83	120	215	63	113	183	(43)	1,306
Depreciation and amortisation	(76)	(34)	(18)	(39)	(92)	(100)	(53)	(37)	(27)	(29)	(1)	(506)
Underlying EBIT^(b)	67	167	70	101	(9)	20	162	26	86	154	(44)	800
Comprising:												
Group Production	67	167	70	101	(12)	20	162	26	86	154	(74)	767
Third party products ^(a)	-	-	-	-	-	-	-	-	-	-	30	30
Share of operating profit of equity accounted investments	-	-	-	-	3	-	-	-	-	-	-	3
Underlying EBIT	67	167	70	101	(9)	20	162	26	86	154	(44)	800
Net finance costs ^(c)												(103)
Income tax expense												(163)
Underlying Earnings												534
Earnings adjustments												204
Profit after tax												738
Capital expenditure	27	10	5	5	58	180	57	37	18	14	-	411
Investments accounted for using the equity method	-	-	-	-	13	-	-	-	-	-	-	13
Total assets^(d)	3,793	1,502	719	1,078	2,051	1,770	1,343	1,100	1,082	402	11,883	26,723
Total liabilities^(d)	380	307	91	140	1,037	236	453	298	228	210	5,796	9,176

US\$M	Worsley Alumina	South Africa Aluminium	Mozal Aluminium	Brazil Aluminium	South Africa Energy Coal	Illawarra Metallurgical Coal	Australia Manganese	South Africa Manganese	Cerro Matoso	Cannington	Group and unallocated items / eliminations	Total South32
Half year ended 31 December 2013												
Revenue												
Group Production	223	796	291	266	639	410	677	350	315	605	-	4,572
Third party products ^(a)	-	-	-	-	-	-	-	-	-	-	776	776
Inter-segment revenue	342	-	-	-	-	-	-	-	-	-	(342)	-
Total revenue	565	796	291	266	639	410	677	350	315	605	434	5,348
Underlying EBITDA^(b)	108	84	17	35	54	70	252	21	43	272	20	976
Depreciation and amortisation	(63)	(36)	(18)	(42)	(98)	(78)	(36)	(30)	(42)	(21)	(2)	(466)
Underlying EBIT^(b)	45	48	(1)	(7)	(44)	(8)	216	(9)	1	251	18	510
Comprising:												
Group Production	45	48	(1)	(7)	(51)	(8)	216	(9)	1	251	(10)	475
Third party products ^(a)	-	-	-	-	-	-	-	-	-	-	28	28
Share of operating profit of equity accounted investments	-	-	-	-	7	-	-	-	-	-	-	7
Underlying EBIT	45	48	(1)	(7)	(44)	(8)	216	(9)	1	251	18	510
Net finance costs ^(c)												(65)
Income tax expense												(76)
Underlying Earnings												369
Earnings adjustments												(11)
Profit after tax												358
Capital expenditure	22	7	3	7	22	173	58	32	35	30	5	394
Investments accounted for using the equity method	-	-	-	-	7	-	-	-	-	-	-	7
Total assets^(d)	3,496	1,629	763	1,282	2,296	1,678	1,325	1,102	1,171	413	4,528	19,683
Total liabilities^(d)	634	230	129	272	983	365	438	289	234	169	5,651	9,394

- (a) Third party products purchased and sold by South32 Marketing comprise US\$358 million (2013: US\$456 million) for aluminium, US\$46 million (2013: US\$317 million) for coal and US\$ nil (2013: US\$3 million) for manganese. Underlying EBIT on third party products comprise US\$17 million (2013: US\$ nil million) for aluminium, US\$13 million (2013: US\$28 million) for coal and US\$ nil (2013: US\$ nil million) for manganese.
- (b) Underlying EBIT is earnings before net finance costs, taxation and any earnings adjustments. Underlying EBIT is reported net of South32's share of net finance costs and taxation of equity accounted investments. Underlying EBITDA is Underlying EBIT, before depreciation and amortisation.
- (c) Excludes interest income and interest expense on borrowings with BHP Billiton. Refer to note 5 Net finance costs.
- (d) Total segment assets and liabilities represent operating assets and liabilities and predominantly excludes cash balances, interest bearing liabilities and deferred tax balances. Total segment assets of equity accounted investments represent the balance of South32's investment in equity accounted investments, and therefore include cash balances, interest bearing liabilities and deferred tax balances.

The following items are excluded from profit/(loss) from operations in arriving at Underlying EBIT each period irrespective of materiality:

- Exchange gains/losses on restatement of monetary items
- Impairment losses/reversals
- Net gains/loss on disposal and consolidation of interests in businesses
- Fair value gain/loss on derivative instruments
- Major corporate restructures

In addition to these, items that do not reflect the underlying operations of South32, and are individually significant to the financial statements are excluded. Such items included within South32's profit or loss for the Reporting Period are detailed in note 3 Significant items.

In calculating Underlying Earnings adjustments are also made to dividend income, net finance costs and taxation for amounts with BHP Billiton that will not continue post Demerger and are reflected in the underlying operations.

The following table shows earnings adjustments in arriving at Underlying Earnings:

US\$M	H1 FY2015	H1 FY2014
Earnings adjustments to Underlying EBIT		
Exchange gains on restatement of monetary items	(82)	(47)
Impairment losses	–	–
Impairment reversals	–	(2)
Fair value (gain)/loss on derivative instruments	(5)	16
Dividends received from BHP Billiton	(364)	(11)
Total earnings adjustments to Underlying EBIT	(451)	(44)
Earnings adjustments to net finance costs		
Exchange variations on net debt	(105)	(1)
Interest on borrowings from BHP Billiton	64	61
Interest income on loans to BHP Billiton	(25)	(17)
Total earnings adjustments to net finance costs	(66)	43
Earnings adjustments to income tax expense		
Tax effect of earnings adjustments to Underlying EBIT	27	8
Tax effect of earnings adjustments to net finance costs	20	(13)
Exchange rate movements	155	3
Remeasurement of deferred tax assets associated with the MRRT	111	(25)
Non-recognition of tax benefits where benefit remains with BHP Billiton	–	39
Total earnings adjustments to income tax expense	313	12
Total earnings adjustments	(204)	11

Geographical information

	Revenue by location of customer	
	H1 FY2015 US\$M	H1 FY2014 US\$M
Australia	336	430
China	488	787
India	361	383
Japan	399	358
Middle East	66	237
Singapore	168	230
South Korea	164	335
Rest of Asia	757	189
United Kingdom	77	185
Europe	1,136	1,231
North America	355	248
Southern Africa	638	567
Rest of world	95	168
Total revenue	5,040	5,348

3 Significant items

Significant items are those items where their nature and amount were considered material to the South32 historical combined financial information. Such items included within South32's profit for the period are detailed below.

	H1 FY2015 US\$M	H1 FY2014 US\$M
Significant items by nature		
Repeal of Mineral Resource Rent Tax legislation	111	-
Total significant items	111	-

31 December 2014

On 2 September 2014, legislation to repeal the Minerals Resource Rent Tax (MRRT) in Australia received the support of both Houses of Parliament and took effect on 30 September 2014. As a result, South32 derecognised a MRRT deferred tax asset (net of income tax consequences) of US\$111 million and a corresponding income taxation charge of US\$111 million was recognised in the half year ended 31 December 2014.

31 December 2013

No significant items during the period ended 31 December 2013.

4 Other income

	H1 FY2015 US\$M	H1 FY2014 US\$M
External dividend income	1	1
Dividend income from BHP Billiton	364	11
External other income	156	93
Total other income	521	105

5 Net finance costs

	H1 FY2015 US\$M	H1 FY2014 US\$M
Financial expenses		
Interest on bank loans and overdrafts	1	1
Interest on all other borrowings	6	5
Finance lease and hire purchase interest	32	2
Discounting on provisions and other liabilities	77	62
Net interest expense on post-retirement employee benefits	6	6
Exchange variations on net debt	(105)	(1)
Financial expenses excluding BHP Billiton	17	75
Interest on borrowings from BHP Billiton	64	61
Total financial expenses	81	136
Financial income		
Interest income	(19)	(11)
Interest income on loans to BHP Billiton	(25)	(17)
Total financial income	(44)	(28)
Net finance costs	37	108

6 Income tax and deferred tax

	H1 FY2015 US\$M	H1 FY2014 US\$M
Total taxation expense comprises:		
Income tax expense	380	113
Royalty-related taxation	96	(25)
Total taxation expense	476	88

Total taxation expense including royalty-related taxation, significant items and exchange rate movements, was US\$476 million, representing an effective tax rate of 39.2 per cent (31 December 2013: 19.7 per cent).

Exchange rate movements increased taxation expense by US\$155 million, representing an increase in the effective tax rate of 12.8 per cent (31 December 2013: increase of US\$3 million and increase of 0.7 per cent).

Government imposed royalty arrangements calculated by reference to profits are reported as royalty-related taxation. Total royalty-related taxation increased taxation expense by US\$96 million resulting in an increase in the effective tax rate of 7.9 per cent (31 December 2013: decrease of US\$25 million and 5.6 per cent).

7 Earnings, dividends and asset information per share

	H1 FY2015	H1 FY2014
Basic earnings per share (US cents)	12.92	5.95
Diluted earnings per share (US cents)	12.88	5.94
Basic earnings (US\$M)	688	317
Diluted earnings (US\$M)	688	317
Headline earnings per share (US cents)	12.92	5.92
Headline earnings (US\$M)	688	315
Net asset value per share (US cents) ^(a)	330	193
Tangible net asset value per share (US cents) ^(b)	324	187
Dividends per share (US cents) ^(c)	12	6

(a) Net asset value per share is calculated by dividing South32's total net assets by the basic number of ordinary shares outstanding.

(b) Tangible net asset value per share is calculated by dividing South32's total net assets less intangible assets by the basic number of ordinary shares outstanding.

(c) Dividends per share are calculated by dividing South32's dividends paid by the basic number of ordinary shares outstanding.

The number of shares used for the purpose of calculating amounts per share is based on the proposed capital structure of South32 at the time of the Demerger being a one for one share issue as follows:

	H1 FY2015 Million	H1 FY2014 Million
Weighted average number of ordinary shares		
Basic earnings per share denominator	5,324	5,324
Shares and options contingently issuable under employee share ownership plans	17	16
Diluted earnings per share denominator	5,341	5,340

Headline earnings

Headline earnings per share has been calculated in accordance with the South African Circular 2/2013 entitled "Headline Earnings", which forms part of the listing requirements for the JSE. The adjustments made to arrive at the headline earnings are as follows:

	H1 FY2015 US\$M	H1 FY2014 US\$M
Profit for the year attributable to owners of the parent	688	317
Impairment reversals	-	(2)
Headline earnings	688	315

Financial risk management strategy

All financial assets and financial liabilities, other than derivatives, are initially recognised at the fair value of consideration paid or received, net of transaction costs as appropriate, and subsequently carried at fair value or amortised cost, as indicated in the tables below. Derivatives are initially recognised at fair value on the date the contract is entered into and are subsequently remeasured at their fair value.

During the Half Year Reporting Period, the majority of BHP Billiton's debt was raised under central borrowing programs, and BHP Billiton has funded its businesses through intercompany investments and loans. Interest rate risk for South32 has been managed as part of the portfolio risk management strategy of BHP Billiton's central treasury function.

Financial assets and liabilities

31 December 2014	Loans and receivables US\$M	Available for sale securities US\$M	Held at fair value through profit or loss US\$M	Other financial assets and liabilities at amortised cost US\$M	Total US\$M
Financial assets					
Cash and cash equivalents	459	–	–	–	459
Trade and other receivables ^(a)	1,025	–	–	–	1,025
Trade receivables from BHP Billiton	370	–	–	–	370
Other derivative contracts	–	–	78	–	78
Interest bearing loans receivable	88	–	–	–	88
Interest bearing loans receivable from BHP Billiton	9,137	–	–	–	9,137
Shares – available for sale	–	308	–	–	308
Other investments	–	136	–	–	136
Total financial assets	11,079	444	78	–	11,601
Non-financial assets					15,122
Total assets					26,723
Financial liabilities					
Trade and other payables ^(b)	–	–	–	1,264	1,264
Payables to BHP Billiton	–	–	–	41	41
Other derivative contracts	–	–	24	–	24
Unsecured bank overdrafts and short-term borrowings	–	–	–	10	10
Unsecured bank loans	–	–	–	111	111
Finance leases	–	–	–	695	695
Unsecured other	–	–	–	196	196
Interest bearing liabilities payable to BHP Billiton	–	–	–	3,728	3,728
Total financial liabilities	–	–	24	6,045	6,069
Non-financial liabilities					3,107
Total liabilities					9,176

(a) Excludes input taxes of US\$170 million (2013: US\$261 million) included in other receivables.

(b) Excludes input taxes of US\$2 million (2013: US\$120 million) included in other payables.

31 December 2013	Loans and receivables US\$M	Available for sale securities US\$M	Held at fair value through profit or loss US\$M	Other financial assets and liabilities at amortised cost US\$M	Total US\$M
Financial assets					
Cash and cash equivalents	196	–	–	–	196
Trade and other receivables	1,145	–	–	–	1,145
Trade receivables from BHP Billiton	590	–	–	–	590
Commodity contracts	–	–	6	–	6
Other derivative contracts	–	–	38	–	38
Interest bearing loans receivable	295	–	–	–	295
Interest bearing loans receivable from BHP Billiton	1,174	–	–	–	1,174
Shares – available for sale	–	333	–	–	333
Other investments	–	137	–	–	137
Total financial assets	3,400	470	44	–	3,914
Non-financial assets					15,769
Total assets					19,683
Financial liabilities					
Trade and other payables	–	–	–	1,731	1,731
Payables to BHP Billiton	–	–	–	136	136
Commodity contracts	–	–	6	–	6
Other derivative contracts	–	–	7	–	7
Unsecured bank overdrafts and short-term borrowings	–	–	–	38	38
Unsecured bank loans	–	–	–	264	264
Finance leases	–	–	–	31	31
Unsecured other	–	–	–	220	220
Interest bearing liabilities payable to BHP Billiton	–	–	–	3,808	3,808
Total financial liabilities	–	–	13	6,228	6,241
Non-financial liabilities					3,153
Total liabilities					9,394

Fair value hierarchy

The carrying amount of financial assets and liabilities measured at fair value is principally calculated with reference to quoted prices in active markets for identical assets or liabilities. Where no price information is available from a quoted market source, alternative market mechanisms or recent comparable transactions, fair value is estimated based on South32's views on relevant future prices, net of valuation allowances to accommodate liquidity, modelling and other risks implicit in such estimates. The inputs used in fair value calculations are determined by the relevant BHP Billiton Group Function. BHP Billiton's Group Functions support the Businesses and operate under a defined set of accountabilities authorised by BHP Billiton's Group Management Committee. Movements in the fair value of financial assets and liabilities may be recognised through the income statement or in other comprehensive income. The following table shows South32's financial assets and liabilities carried at fair value with reference to the nature of valuation inputs used.

H1 FY2015	Level 1^(a) US\$M	Level 2^(b) US\$M	Level 3^(c) US\$M	Total US\$M
Financial assets and liabilities				
Other derivative contracts	–	(6)	60	54
Investments – available for sale	–	136	308	444
Total	–	130	368	498

(a) Valuation is based on unadjusted quoted prices in active markets for identical financial assets and liabilities.

(b) Valuation is based on inputs (other than quoted prices included in Level 1) that are observable for the financial asset or liability, either directly (i.e. as unquoted prices) or indirectly (i.e. derived from prices).

(c) Valuation is based on inputs that are not based on observable market data.

Level 3 financial assets and liabilities

The following table shows the movements in South32's level 3 financial assets and liabilities.

	H1 FY2015 US\$M
At the beginning of the financial year	365
Unrealised gains recognised in the income statement ^(a)	12
Unrealised losses recognised in other comprehensive income ^(b)	(9)
At the end of the financial year	368

(a) Realised and unrealised gains and losses recognised in the income statement are recorded in expenses.

(b) Unrealised gains and losses recognised in other comprehensive income are recorded in invested capital.

Sensitivity of Level 3 financial assets and liabilities

The carrying amount of financial assets and liabilities that are valued using inputs other than observable market data are calculated using appropriate valuation models, including discounted cash flow modelling, with inputs such as commodity prices, foreign exchange rates and inflation. The potential effect of using reasonably possible alternative assumptions in these models, based on a change in the most significant input by 10 per cent while holding all other variables constant, is shown in the following table. Significant inputs are assessed individually for each financial asset and liability.

	Profit after taxation			Equity	
	Carrying value US\$M	10% increase in input US\$M	10% decrease in input US\$M	10% increase in input US\$M	10% decrease in input US\$M
H1 FY2015					
Financial assets and liabilities					
Other derivative contracts	60	13	(13)	13	(13)
Investments – available for sale	308	–	–	59	57
Total	368	13	(13)	72	44

During the period to 31 December 2014, as part of the process of South32 legally acquiring the entities that comprise its business operations and which are included in this half year historical combined financial information, an equity injection of US\$8 billion was made by BHP Billiton Limited. As at 31 December 2014 some of these funds have been loaned back to an entity within BHP Billiton pending legal acquisition of the specific entities. The net assets of the entities to be acquired are already included in the combined balance sheet of South32. Accordingly, as the entities are acquired the receivable from BHP Billiton Group companies will decrease reflecting a return of invested capital to BHP Billiton.

9 Contingent liabilities

Contingent liabilities at balance date, not otherwise provided for in the financial statements, are categorised as arising from:

	H1 FY2015 US\$M	H1 FY2014 US\$M
Subsidiaries and joint operations		
Bank guarantees	6	4
Actual or potential litigation ^(a)	653	622
Other	26	12
Total contingent liabilities	685	638

(a) Actual or potential litigation amounts relate to a number of actions against South32, some of which relate to commercially confidential information, none of which were individually significant to BHP Billiton and where BHP Billiton has historically assessed that the liability is not probable and therefore South32 has not provided for such amounts in the historical combined financial statements. The actual or potential litigation relates primarily to numerous tax assessments or matters arising from tax audits relating to transactions in prior years in Brazil, Colombia and South Africa. Additionally, there are a number of legal claims or potential claims against South32, the outcome of which cannot be foreseen at present, and for which no amounts have been included in the table above.

10 Subsequent events

In contemplation of the proposed Demerger, BHP Billiton and Anglo American agreed to make certain changes to the agreement which governs their interests in the Manganese Business. South32 will acquire BHP Billiton's interest and following implementation of the Demerger, South32 will manage and own 60 per cent of the Manganese Business with Anglo American owning the remaining 40 per cent.

Following receipt on 2 March 2015 of the last of the approvals required for the agreement, the changes result in South32 and Anglo American agreeing to share joint control of the Manganese Business. With effect from this date South32 will discontinue consolidation of the Manganese Business and account for its 60 per cent interest as an equity accounted joint venture. South32 will therefore derecognise the existing carrying amounts of all assets, liabilities and the non-controlling interest in the Manganese Business attributed to Anglo American and initially records its retained 60 per cent interest at fair value. The remeasurement at fair value gives rise to a gain of approximately US\$2 billion. There are no tax consequences arising from the remeasurement of the Manganese Business.

Following the move to equity accounting, South32 received a dividend from Australia Manganese that decreased the carrying value of the investment in the Manganese Business by US\$342 million.

Other than the matters outlined above or elsewhere in this half year historical combined financial information, no matters or circumstances have arisen since the end of the half year that have significantly affected, or may significantly affect, the operations, results of operations or state of affairs of South32 in subsequent accounting periods.

2.7 INDEPENDENT REVIEW REPORT



Independent Review Report of KPMG (“KPMG Australia”) and KPMG Inc (“KPMG South Africa”) to the Directors of South32 Limited

We have reviewed the accompanying half year historical combined financial information of the South32 Limited Group (as defined in this Document, the “Group”), being special purpose financial information as at and for the half-years ended 31 December 2013 and 31 December 2014 prepared for the purpose of the Group’s listing on the Johannesburg Stock Exchange (“JSE”) and admission to the Official List of the Financial Conduct Authority (“FCA”) of the United Kingdom. The half year historical combined financial information comprises, for each of the periods described above: the combined balance sheet and combined statement of invested capital as at the period end; the combined income statement, combined statement of comprehensive income and cash flow statement for the period then ended; and notes comprising a summary of significant accounting policies and other explanatory information. The historical combined financial information has been prepared by the Directors using the basis of preparation set out in Note 1 to the historical combined financial information and in compliance with the respective listing requirements of the JSE and of the FCA.

Directors’ responsibility for the historical combined financial information

The Directors of the Group are responsible for the preparation and fair presentation of the half year historical combined financial information in accordance with the basis of preparation set out in Note 1 to the half year historical combined financial information and the respective listing requirements of the JSE and of the FCA. The Directors’ responsibility also includes determining the acceptability of the basis of preparation in the circumstances and for such internal controls as the Directors determine are necessary to enable the preparation and presentation of the half year historical combined financial information that is free from material misstatement, whether due to fraud or error.

Auditor’s responsibility

Our responsibility is to express a conclusion on the half year historical combined financial information based on our review.

- KPMG Australia conducted a review of the half year historical combined financial information in accordance with Australian Auditing Standard on Review Engagements 2410 *Review of Interim and Other Financial Reports Performed by the Independent Auditor of the Entity* as issued by the Australian Auditing and Assurance Standards Board and International Standard on Review Engagements (UK and Ireland) 2410 *Review of Interim Financial Information Performed by the Independent Auditor of the Entity* issued by the Auditing Practices Board for use in the United Kingdom.
- KPMG South Africa conducted a review of the half year historical combined financial information in accordance with International Standard on Review Engagements 2410 *Review of Interim Financial Information Performed by the Independent Auditor of the Entity*.

These standards require that we comply with relevant ethical requirements.

A review consists of making enquiries, primarily of persons responsible for financial and accounting matters, and applying analytical and other review procedures. A review is substantially less in scope than an audit conducted in accordance with auditing standards and consequently does not enable us to obtain assurance that we would become aware of all significant matters that might be identified in an audit. Accordingly, we do not express an audit opinion.

We believe that the evidence we have obtained is sufficient and appropriate to provide a basis for our review conclusion.

KPMG, an Australian partnership, and KPMG Inc, a South African company incorporated under the South African Companies Act, are member firms of the KPMG network of independent member firms affiliated with KPMG International Cooperative (“KPMG International”), a Swiss entity.

KPMG Australia’s liability limited by a scheme approved under Professional Standards Legislation

KPMG Inc is a Registered Auditor, in public practice, in terms of the Auditing Profession Act, 26 of 2005.

Registration number 1999/021543/21

KPMG Inc’s Policy Board:

Chief Executive: RM Kgosana

Executive Directors: T Fubu, A Hari, E Magondo, JS McIntosh, CAT Smit, D van Heerden

Other Directors: DC Duffield, LP Fourie, N Fubu, TH Hoole, A Jaffer, M Letsitsi,

A Masemola, M Mokgabudi, Y Suleman (Chairman of the Board), A Thunström

KPMG Inc’s principal place of business is at KPMG Crescent, 85 Empire Road, Parktown, where a list of the directors’ names is available for inspection.



Independence

In conducting our review, KPMG Australia has complied with the independence requirements of the Australian Accounting Professional and Ethical Standards Board.

Review conclusion

Based on our review, which is not an audit, nothing has come to our attention that causes us to believe that the half year historical combined financial information of the Group as at and for the half years ended 31 December 2013 and 31 December 2014 is not presented fairly, in all material respects, in accordance with Note 1 to the half year historical combined financial information and the respective listing requirements of the JSE and of the FCA.

Basis of preparation

Without modifying our review conclusion, we draw attention to Note 1 to the half year historical combined financial information which describes the basis of preparation of the half year historical combined financial information, including the approach to and the purpose for preparing the information and that the preparation involves complex allocations of certain items. Consequently, the half year historical combined financial information may not necessarily be indicative of the financial performance that would have been achieved if the South32 Group had operated as an independent group, nor may it be indicative of the results of operations of the South32 Group for any future period.

The half year historical combined financial information has been prepared solely for the purpose of fulfilling the Directors' financial reporting responsibilities in order to comply with the respective listing requirements of the JSE and of the FCA. As a result, the half year historical combined financial information may not be suitable for another purpose.

Declaration for the purposes of the Prospectus Directive Regulation as required by the FCA

This report is required by paragraph 20.6.1 of Annex I of the Prospectus Directive Regulation and is given for the purpose of complying with that paragraph and for no other purpose. For the purposes of Prospectus Rule 5.5.3R (2)(f) we are responsible for this report as part of the prospectus and declare that we have taken all reasonable care to ensure that the information contained in this report is, to the best of our knowledge, in accordance with the facts and contains no omission likely to affect its import. This declaration is included in the prospectus in compliance with paragraph 1.2 of Annex I of the Prospectus Directive Regulation.



KPMG

Chris Sargent
Partner

Melbourne, Australia
16 March 2015

KPMG Inc.
Per Jacques Erasmus
Chartered Accountant (SA), Registered Auditor, Director

Johannesburg, South Africa
16 March 2015

KPMG, an Australian partnership, and KPMG Inc, a South African company incorporated under the South African Companies Act, are member firms of the KPMG network of independent member firms affiliated with KPMG International Cooperative ("KPMG International"), a Swiss entity.

KPMG Australia's liability limited by a scheme approved under Professional Standards Legislation

KPMG Inc is a Registered Auditor, in public practice, in terms of the Auditing Profession Act, 26 of 2005.

Registration number 1999/021543/21

KPMG Inc's Policy Board:
Chief Executive: RM Kgosana
Executive Directors: T Fubu, A Hari, E Magondo, JS McIntosh, CAT Smit, D van Heerden
Other Directors: DC Duffield, LP Fourie, N Fubu, TH Hooile, A Jaffer, M Letsitsi, A Masemola, M Mokgabudi, Y Suleman (Chairman of the Board), A Thunström

KPMG Inc's principal place of business is at KPMG Crescent, 85 Empire Road, Parktown, where a list of the directors' names is available for inspection.

This page has been intentionally left blank.

ANNEXURE 3

SOUTH32 PRO FORMA HISTORICAL CONSOLIDATED INCOME STATEMENT AND CASH FLOW STATEMENT RECONCILIATIONS

3.1 OVERVIEW

This Annexure sets out the reconciliation of pro forma adjustments made to the historical combined financial information set out in Annexures 1 and 2 to derive the summary pro forma historical consolidated income statements and summary pro forma historical consolidated cash flow statements. The pro forma financial information has been prepared on the basis of preparation set out in Section 10.2. The continuing effects of the pro forma adjustments set out in this Annexure are as follows:

- the share of Manganese operating profit/(loss) will be equity accounted into the South32 Group, while the consolidation of Manganese profits will not recur;
- South32 will incur financing and tax costs based on its post Demerger structure.

3.2 RECONCILIATION OF PRO FORMA HISTORICAL CONSOLIDATED INCOME STATEMENT

Table A3.1: Reconciliation of South32 historical combined income statement to South32 pro forma historical consolidated income statement

H1 FY2015 US\$M	Change of control of Manganese Business				South32 pro forma consolidated financial information
	South32 combined financial information ^(a)	Removal of consolidated results ^(b)	Equity accounted profit/(loss) ^(c)	Intercompany financing ^(d)	
Revenue	5,040	(951)	–	–	4,089
Other income	521	(7)	–	(364)	150
Expenses excluding net finance costs	(4,313)	763	–	–	(3,550)
Share of operating profit of equity accounted investments	3	–	32	–	35
Profit from operations	1,251	(195)	32	(364)	724
Net finance costs	(37)	3	–	39	5
Taxation expense	(476)	65	–	(12)	(423)
Profit after taxation	738	(127)	32	(337)	306
Other financial information					
Profit from operations	1,251	(195)	32	(364)	724
Earnings adjustments ^(e)	(451)	17	(6)	364	(76)
Underlying EBIT	800	(178)	26	–	648
Depreciation and amortisation	506	(89)	–	–	417
Underlying EBITDA	1,306	(267)	26	–	1,065
Profit after taxation	738	(127)	32	(337)	306
Earnings adjustments after taxation ^(e)	(204)	9	(6)	337	136
Underlying Earnings	534	(118)	26	–	442

(a) South32's historical combined income statement has been extracted, without material adjustment from the historical combined financial information in Annexures 1 and 2.

- (b) A pro forma adjustment has been made to reflect the loss of control and subsequent de-consolidation of the Manganese Business assuming the changes to the shareholder agreement were effective 1 July 2013. This information has been extracted, without material adjustment from the underlying accounting records of South32. The de-consolidation of the Manganese Business includes Australia Manganese, South Africa Manganese and certain balances and transactions included within South32 Group and Unallocated representing the Manganese Business' share of central functions, consolidation adjustments and sale of third party product. For this reason, the de-consolidation pro forma adjustment will not fully reconcile with Australia Manganese and South Africa Manganese results contained in note 2 Segment reporting to the historical combined financial information in Annexures 1 and 2.
- (c) The adjustment represents South32's equity share of the profit/(loss) after taxation of the equity accounted investment in the Manganese Business. This adjustment has been calculated from the underlying accounting records of South32 and adjusted for the impact of additional depreciation arising from the uplift in the fair value of the Manganese Business. Also refer to 'Equity accounted investment in Manganese Business' in Section 10.8(b) under accounting judgements and estimates.

US\$M	H1 FY2015	FY2014
Profit after taxation of Manganese Business	127	214
Attributable to non controlling interests	(50)	(85)
Attributable to members of South32	77	129
Depreciation charge on fair value uplift (after taxation)	(45)	(80)
Share of operating profit of equity accounted investment in Manganese Business	32	49

- (d) This adjustment reflects the removal of the historical net finance costs associated with BHP Billiton centrally managed borrowings, and the removal of dividends received from BHP Billiton. Both adjustments have been tax effected at 30 per cent. Net finance costs and dividends associated to BHP Billiton have been extracted, without material adjustment from the historical combined financial information in Annexures 1 and 2.

- (e) Further details regarding earnings adjustments are set out in Table A3.3.

Table A3.2: Reconciliation of South32 historical combined income statement to South32 pro forma historical consolidated income statement

FY2014 US\$M	Change of control of Manganese Business				South32 pro forma consolidated financial information
	South32 combined financial information ^(a)	Removal of consolidated results ^(b)	Equity accounted profit/(loss) ^(c)	Intercompany financing ^(d)	
Revenue	10,444	(2,100)	–	–	8,344
Other income	310	(30)	–	(11)	269
Expenses excluding net finance costs	(9,990)	1,652	–	–	(8,338)
Share of operating profit of equity accounted investments	10	–	49	3	62
Profit from operations	774	(478)	49	(8)	337
Net finance costs	(352)	81	–	84	(187)
Taxation expense	(205)	183	–	(25)	(47)
Profit after taxation	217	(214)	49	51	103
Other financial information					
Profit from operations	774	(478)	49	(8)	337
Earnings adjustments ^(e)	296	15	4	8	323
Underlying EBIT	1,070	(463)	53	–	660
Depreciation and amortisation	985	(162)	–	–	823
Underlying EBITDA	2,055	(625)	53	–	1,483
Profit after taxation	217	(214)	49	51	103
Earnings adjustments after taxation ^(e)	397	(7)	4	(51)	343
Underlying Earnings	614	(221)	53	–	446

See notes to Table A3.1

3.3 UNDERLYING EARNINGS AND EARNINGS ADJUSTMENTS

In discussing the operating results of South32, the focus is on Underlying Earnings. Underlying Earnings is the key measure that South32 proposes to use to assess the performance of the South32 Group, make decisions on the allocation of resources and assess senior management. In addition the performance of each of the South32 Businesses (described in 7.1(a) to 7.1(j)) and operational management will be assessed based on Underlying EBIT. South32 management will use this measure because financing structures and tax regimes differ across the South32 Businesses and substantial components of historical tax and interest charges are levied at a South32 level rather than Business level. In order to calculate Underlying Earnings, Underlying EBIT and Underlying EBITDA, the following items are adjusted as applicable each period irrespective of materiality:

- exchange gains/losses on restatement of monetary items;
- impairment losses/reversals;
- net gains/loss on disposal and consolidation of interests in businesses;
- fair value gain/loss on derivative instruments;
- major corporate restructures;
- the income tax impact of the above items.

In addition to these, items that do not reflect the underlying operations of South32, and are individually significant to the financial statements, are excluded. Such items included within South32's profit or loss for the Reporting Period are detailed in note 3 Significant items to the historical combined financial information in Annexures 1 and 2.

The accounting policies proposed by South32 for calculating these measures differ from those currently used by BHP Billiton, the key differences being that South32 will adjust for the items above each period, irrespective of materiality, and South32 management will retain the discretion to adjust for other significant non-recurring items that are not considered to reflect the underlying performance of the assets it holds.

Refer to Section 11.5(d) for a description of the components of Underlying Earnings adjustments. In calculating Underlying Earnings, adjustments are also made to net finance costs and taxation for amounts that will not continue post the Demerger and are not reflective of the underlying operations.

The following table shows the pro forma earnings adjustments to the South32 pro forma consolidated income statements for H1 FY2015 and FY2014.

Table A3.3: South32 pro forma earnings adjustments

US\$M	H1 FY2015	FY2014
Earnings adjustments to Underlying EBIT		
Exchange gains on restatement of monetary items	(64)	(53)
Impairment losses	–	327
Impairment reversals	–	(8)
Fair value (gain)/loss on derivative instruments	(6)	2
Other:		
Bayside closure costs (excluding impairments)	–	138
Gain on sale of Optimum coal rights	–	(84)
Equity share of earnings adjustment to Manganese after net finance costs and taxation	(6)	1
Total earnings adjustments to Underlying EBIT	(76)	323
Earnings adjustment to net finance costs		
Exchange variation on net debt	(93)	40
Total earnings adjustment to net finance costs	(93)	40
Earnings adjustments to income tax expense		
Tax effect of earnings adjustments to Underlying EBIT	22	(25)
Tax effect of earnings adjusted to net finance costs	28	(13)
Exchange rate movements	144	(9)
Re-measurements of deferred tax assets associated with the MRRT	111	–
Non-recognition of tax benefits where benefit remains with BHP Billiton	–	27
Total earnings adjustments to income tax expense	305	(20)
Total earnings adjustments	136	343

3.4 RECONCILIATION OF PRO FORMA HISTORICAL CONSOLIDATED CASH FLOW STATEMENT

Table A3.4: Reconciliation of South32 historical combined cash flow statement to South32 pro forma consolidated cash flow statement before financing activities and tax and after capital expenditure

H1 FY2015 US\$M	Change of control in Manganese Business				South32 pro forma consolidated financial information
	South32 combined financial information ^(a)	Removal of consolidated results ^(b)	Equity accounted profit/(loss) ^(c)	Intercompany financing ^(d)	
Profit from operations	1,251	(195)	32	(364)	724
Other non-cash items	178	(97)	–	364	445
Profit from equity accounted investments	(3)	–	(32)	–	(35)
Change in working capital	(295)	90	–	–	(205)
Cash generated from operations	1,131	(202)	–	–	929
Dividends received (including equity accounted investments)	368	–	127	(364)	131
Capital expenditure	(411)	94	–	–	(317)
Net operating cash flows before financing activities and tax and after capital expenditure	1,088	(108)	127	(364)	743

(a) South32's historical combined cash flow statement has been extracted, without material adjustment from the historical combined financial information in Annexures 1 and 2.

(b) A pro forma adjustment has been made to reflect the loss of control and subsequent de-consolidation of the Manganese Business assuming the changes to the shareholder agreement were effective 1 July 2013. This information has been extracted, without material adjustment from the underlying accounting records of South32.

(c) The adjustment represents South32's share of the operating profit/(loss) and dividends received from the equity accounted investments being South32's equity share of the Manganese Business. This information has been derived from the underlying accounting records of South32. South32's equity accounted profit/(loss) is set out in footnote (c) to Table A3.1. Dividends received by South32 represent 60 per cent of dividends paid by the companies that represent the Manganese Business.

(d) Pro forma adjustment reflects the removal of the impact of intercompany dividends received by South32 from BHP Billiton which have been extracted, without material adjustment from the historical combined financial information in Annexures 1 and 2.

Table A3.5: Reconciliation of South32 historical combined cash flow statement to South32 pro forma consolidated cash flow statement before financing activities and tax and after capital expenditure

FY2014 US\$M	Change of control in Manganese Business				South32 pro forma consolidated financial information
	South32 combined financial information ^(a)	Removal of consolidated results ^(b)	Equity accounted profit/(loss) ^(c)	Intercompany financing ^(d)	
Profit from operations	774	(478)	49	(8)	337
Other non-cash items	1,267	(149)	–	11	1,129
Profit from equity accounted investments	(10)	–	(49)	(3)	(62)
Change in working capital	77	(62)	–	–	15
Cash generated from operations	2,108	(689)	–	–	1,419
Dividends received (including equity accounted investments)	31	(12)	198	(11)	206
Capital expenditure	(769)	179	–	–	(590)
Net operating cash flows before financing activities and tax and after capital expenditure	1,370	(522)	198	(11)	1,035

See notes to Table A3.4

ANNEXURE 4

SOUTH32 PRO FORMA SEGMENT REPORTING

The pro forma segment reporting financial information for the South32 Businesses for H1 FY2015 and FY2014 is set out below. The segment information reflects South32's interest in the Manganese Business on a proportional consolidation basis, which is the proposed measure that will be used by South32's management to assess the performance of the Manganese Business. The statutory adjustment column reconciles the proportional consolidation of the Manganese Business to the treatment of the Manganese Business on an equity accounted basis as set out in the pro forma financial information in Section 10 and Annexure 3.

Table A4.1: South32 pro forma segment reporting half year ended 31 December 2014

H1 FY2015 US\$M	Worsley Alumina	South Africa Aluminium	Mozal Aluminium	Brazil Aluminium	South Africa Energy Coal	Illawarra Metallurgical Coal	Australia Manganese	South Africa Manganese	Cerro Matoso	Cannington	Group and unallocated items/ eliminations	Statutory adjustment	Total South32
Revenue													
Group Production	319	823	340	268	683	425	339	231	340	486	-	(569)	3,685
Third party products ^(a)	-	-	-	-	-	-	-	-	-	-	404	-	404
Inter-segment revenue	332	-	-	-	-	-	-	-	-	-	(332)	-	-
Total revenue	651	823	340	268	683	425	339	231	340	486	72	(569)	4,089
Underlying EBITDA^(b)	143	201	88	140	83	120	129	38	113	183	(32)	(141)	1,065
Depreciation and amortisation	(76)	(34)	(18)	(39)	(92)	(100)	(83)	(33)	(27)	(29)	(2)	116	(417)
Underlying EBIT^(b)	67	167	70	101	(9)	20	46	5	86	154	(34)	(25)	648
Comprising:													
Group Production	67	167	70	101	(12)	20	46	5	86	154	(64)	(51)	589
Third party products	-	-	-	-	-	-	-	-	-	-	30	-	30
Share of operating profit of equity accounted investments ^(c)	-	-	-	-	3	-	-	-	-	-	-	26	29
Underlying EBIT	67	167	70	101	(9)	20	46	5	86	154	(34)	(25)	648
Net finance costs													(88)
Income tax expense													(118)
Underlying Earnings													442
Earnings Adjustments													(136)
Profit/(loss) after tax													306
Capital expenditure	27	10	5	5	58	180	34	22	18	14	-	(56)	317
Investments accounted for using equity method	-	-	-	-	13	-	-	-	-	-	-	3,027	3,040
Total assets^(d)	3,793	1,502	719	1,078	2,051	1,770	1,861	1,305	1,082	402	5,198	(3,076)	17,685
Total liabilities^(d)	380	307	91	140	1,037	236	272	179	228	210	2,106	(451)	4,735

(a) Third party products purchased and sold by South32 Marketing comprise US\$358 million for aluminium (2014: US\$802 million), US\$46 million for coal (2014: US\$456 million) and US\$ nil for manganese (2014: US\$2 million). Underlying EBIT on third party products comprise US\$17 million for aluminium (2014: US\$14 million), US\$13 million for coal (2014: US\$18 million) and US\$ nil for manganese (2014: (US\$2) million).

(b) Underlying EBIT is earnings before net finance costs, taxation and any earnings adjustments items. Underlying EBIT is reported net of South32's share of net finance costs and taxation of equity accounted investments. Underlying EBITDA is Underlying EBIT, before depreciation and amortisation.

(c) Share of operating profit of equity accounted investments includes the impacts of earnings adjustments to Underlying EBIT.

(d) Total segment assets and liabilities represent operating assets and liabilities including the carrying amount of equity accounted investments and predominantly excludes cash balances, interest bearing liabilities and deferred tax balances. The carrying amount of investments accounted for using the equity method represents the balance of the Group's investment in equity accounted investments, with no adjustment for any cash balances, interest bearing liabilities and deferred tax balances of the equity accounted investment.

Table A4.2: South32 pro forma segment reporting year ended 30 June 2014

FY2014 US\$M	Worsley Alumina	South Africa Aluminium	Mozal Aluminium	Brazil Aluminium	South Africa Energy Coal	Illawarra Metallurgical Coal	Australia Manganese	South Africa Manganese	Cerro Matoso	Cannington	Group and unallocated items/ eliminations	Statutory adjustment	Total South32
Revenue													
Group Production	570	1,614	574	529	1,247	878	785	473	595	1,079	-	(1,258)	7,086
Third party products ^(a)	-	-	-	-	-	-	-	-	-	-	1,260	(2)	1,258
Inter-segment revenue	659	-	-	-	-	-	-	-	-	-	(659)	-	-
Total revenue	1,229	1,614	574	529	1,247	878	785	473	595	1,079	601	(1,260)	8,344
Underlying EBITDA^(b)	162	190	52	127	197	135	303	72	87	460	18	(320)	1,483
Depreciation and amortisation	(138)	(69)	(36)	(83)	(193)	(170)	(148)	(62)	(88)	(47)	1	210	(823)
Underlying EBIT^(b)	24	121	16	44	4	(35)	155	10	(1)	413	19	(110)	660
Comprising:													
Group Production	24	121	16	44	(6)	(35)	155	10	(1)	413	(11)	(165)	565
Third party products	-	-	-	-	-	-	-	-	-	-	30	2	32
Share of operating profit of equity accounted investments ^(c)	-	-	-	-	10	-	-	-	-	-	-	53	63
Underlying EBIT	24	121	16	44	4	(35)	155	10	(1)	413	19	(110)	660
Net finance costs													(147)
Income tax expense													(67)
Underlying Earnings													446
Earnings Adjustments													(343)
Profit/(loss) after tax													103
Capital expenditure	56	28	8	9	65	309	65	42	56	60	(1)	(107)	590

See notes to Table A4.1

This page has been intentionally left blank.

SELECTED FINANCIAL METRICS FOR THE PAST 10 FINANCIAL YEARS

Selected financial metrics for each Business for the past 10 financial years are presented below – being Revenue, Underlying EBITDA, Underlying EBIT and Capital Expenditure.

The historical commodity prices for the past 10 financial years are quoted prices obtained from the sources noted under the table.

The historical production and sales volumes for each Business have been extracted from BHP Billiton's Operational Review (previously referred to as the Production Report).

FY2012 to FY2014

The financial information presented for FY2012 to FY2014 has been extracted from the historical combined financial information contained within Annexure 1. The historical combined financial information contained within Annexure 1 has been subject to audit by KPMG.

The calculation of Underlying EBIT and Underlying EBITDA for FY2012 to FY2014 is based on the policy that South32 proposes to use when discussing its operating results in the future. Note 2 Segment reporting to the historical combined financial information in Annexure 1 sets out the adjustments made to arrive at Underlying EBIT and Underlying EBITDA for FY2012 to FY2014.

FY2005 to FY2011

The financial information presented for FY2005 to FY2011 has been extracted from the accounting records of BHP Billiton. For South Africa Energy Coal, Illawarra Metallurgical Coal, Cerro Matoso and Cannington, the information was previously published by BHP Billiton as unaudited supplementary financial information released as part of BHP Billiton's results announcement. For the other South32 Businesses the information represents further dissection of BHP Billiton's previously released unaudited supplementary financial information.

The calculation of Underlying EBIT and Underlying EBITDA for FY2005 to FY2011 is based on BHP Billiton's accounting policy, which excludes exceptional items.

Table A5.1: South32's 10 year history of revenue by Business

Revenue								Per Annexure 1		
	FY2005	FY2006	FY2007	FY2008	FY2009	FY2010	FY2011	FY2012	FY2013	FY2014
Worsley Alumina	594	875	1,203	1,244	878	907	930	992	1,130	1,229
South Africa Aluminium	1,354	1,996	2,492	2,502	1,655	1,767	2,047	1,646	1,663	1,614
Mozal Aluminium	434	640	783	756	542	526	609	629	612	574
Brazil Aluminium	426	627	747	712	484	632	743	660	637	529
South Africa Energy Coal	1,461	1,474	1,502	1,963	1,340	1,143	1,754	1,894	1,458	1,247
Illawarra Metallurgical Coal	416	659	756	706	1,355	1,018	1,525	1,701	1,287	878
Australia Manganese ^(a)	547	396	450	1,255	1,226	1,176	1,297	1,204	1,257	1,308
South Africa Manganese ^(a)	620	448	637	1,505	1,156	884	1,126	932	856	788
Cerro Matoso	768	792	1,856	1,234	680	954	988	876	803	595
Cannington	678	835	982	1,382	816	1,317	1,889	1,590	1,365	1,079
Third party products	2,243	1,988	3,122	3,897	3,770	2,463	2,471	2,359	1,663	1,262
Intersegment revenue	(659)	(870)	(1,018)	(920)	(590)	(898)	(727)	(648)	(638)	(659)
Group and unallocated	167	121	62	84	91	83	-	-	-	-
Total	9,049	9,981	13,574	16,320	13,403	11,972	14,652	13,835	12,093	10,444

(a) Manganese is reported at a 100% consolidation.

Table A5.2: South32's 10 year history of Underlying EBITDA by Business

Underlying EBITDA ^(a)	Per Annexure 1									
	FY2005	FY2006	FY2007	FY2008	FY2009	FY2010	FY2011	FY2012	FY2013	FY2014
Worsley Alumina	345	335	580	517	132	215	189	(67)	60	162
South Africa Aluminium	413	625	857	737	313	386	431	(10)	73	190
Mozal Aluminium	208	247	362	304	174	135	147	51	31	52
Brazil Aluminium	201	220	243	156	(36)	51	11	3	44	127
South Africa Energy Coal	290	190	212	659	317	222	399	416	115	197
Illawarra Metallurgical Coal	115	328	297	297	850	369	740	818	302	135
Australia Manganese ^(b)	340	146	143	834	746	514	536	335	499	505
South Africa Manganese ^(b)	320	(42)	187	824	708	364	350	(18)	111	120
Cerro Matoso	511	511	1,469	806	202	506	370	417	234	87
Cannington	353	491	628	880	310	814	1,232	893	651	460
Third party products	75	113	158	(69)	267	95	63	94	63	29
Group and unallocated	(48)	73	(39)	38	(47)	(88)	(105)	(101)	(65)	(9)
Total	3,123	3,237	5,097	5,983	3,936	3,583	4,363	2,831	2,118	2,055

(a) FY2005–FY2011 based on BHP Billiton policy; FY2012–FY2014 based on South32 policy.

(b) Manganese is reported at a 100% consolidation.

Table A5.3: South32's 10 year history of Underlying EBIT by Business

Underlying EBIT ^(a)	Per Annexure 1									
	FY2005	FY2006	FY2007	FY2008	FY2009	FY2010	FY2011	FY2012	FY2013	FY2014
Worsley Alumina	241	253	480	427	23	109	69	(194)	(115)	24
South Africa Aluminium	283	522	786	634	213	309	352	(83)	1	121
Mozal Aluminium	165	213	334	273	141	104	115	18	(3)	16
Brazil Aluminium	171	196	223	135	(67)	6	(89)	(80)	(40)	44
South Africa Energy Coal	162	7	47	520	250	141	230	226	(96)	4
Illawarra Metallurgical Coal	74	258	167	185	743	245	603	659	154	(35)
Australia Manganese ^(b)	327	133	126	814	723	476	492	282	436	414
South Africa Manganese ^(b)	300	(61)	167	802	687	340	317	(51)	58	48
Cerro Matoso	473	470	1,418	735	129	430	289	337	155	(1)
Cannington	320	448	592	841	279	780	1,197	840	611	413
Third party products	75	113	158	(69)	267	95	63	94	63	29
Group and unallocated	(54)	67	(43)	27	(52)	(99)	(111)	(122)	(70)	(7)
Total	2,537	2,619	4,455	5,324	3,336	2,936	3,527	1,926	1,154	1,070

(a) FY2005–FY2011 based on BHP Billiton policy; FY2012–FY2014 based on South32 policy.

(b) Manganese is reported at a 100% consolidation.

Table A5.4: South32's 10 year history of capital expenditure by Business

Capital expenditure										
	FY2005	FY2006	FY2007	FY2008	FY2009	FY2010	FY2011	FY2012	FY2013	FY2014
Major projects capital expenditure										
Worsley Alumina	78	136	33	103	380	793	1,160	773	77	–
South Africa Aluminium	28	37	25	5	2	8	9	–	–	–
Mozal Aluminium	11	7	4	4	2	3	5	–	–	–
Brazil Aluminium	–	–	–	–	–	85	10	–	–	–
South Africa Energy Coal	23	28	10	115	498	424	179	25	18	6
Illawarra Metallurgical Coal	–	–	–	–	4	45	113	166	277	199
Australia Manganese ^(a)	4	1	5	79	111	13	19	87	136	32
South Africa Manganese ^(a)	13	1	–	–	23	–	–	68	46	59
Cerro Matoso	–	–	37	52	16	48	205	62	7	20
Cannington	–	–	–	–	–	–	4	11	–	–
Third party products	–	–	–	–	–	–	–	–	–	–
Group and unallocated	–	–	–	–	–	–	–	–	–	–
Minor and maintenance capital expenditure										
Worsley Alumina	66	73	48	50	45	78	102	127	77	56
South Africa Aluminium	22	16	21	17	14	17	21	14	17	28
Mozal Aluminium	3	3	4	5	7	5	11	9	7	8
Brazil Aluminium	–	–	–	–	–	20	8	12	6	9
South Africa Energy Coal	50	66	114	81	65	58	97	137	115	59
Illawarra Metallurgical Coal	198	238	203	139	133	151	194	148	80	110
Australia Manganese ^(a)	14	17	42	22	70	61	75	126	135	76
South Africa Manganese ^(a)	21	17	20	40	67	95	148	63	58	11
Cerro Matoso	81	54	54	46	36	24	36	43	43	36
Cannington	28	21	24	31	34	40	45	62	39	60
Third party products	–	–	–	–	–	–	–	–	–	–
Group and unallocated	14	10	–	–	–	–	–	80	1	–
Total	654	725	644	789	1,507	1,968	2,441	2,013	1,139	769

(a) Manganese is reported at a 100% consolidation.

Table A5.5: South32's 10 year history of commodity prices

Average quoted prices										
	FY2005	FY2006	FY2007	FY2008	FY2009	FY2010	FY2011	FY2012	FY2013	FY2014
Metallurgical coal (US\$/t) ^(a)	125	115	98	300	257	147	244	239	159	128
Energy coal (US\$/t) ^(b)	53.51	47.63	51.52	94.60	95.16	75.93	116.70	105.56	84.66	77.48
Aluminium (LME cash) (US\$/t)	1,802	2,260	2,699	2,718	1,862	2,018	2,375	2,168	1,938	1,764
Alumina (US\$/t) ^(c)	389	545	307	391	255	314	369	334	327	321
Manganese Alloys (US\$/t) ^(d)	1,081	683	907	2,255	1,848	1,351	1,369	1,177	1,106	1,020
Manganese Ores (US\$/dmu) ^(e)	N/A	11.16	3.04	11.20	9.43	6.46	6.29	4.90	5.29	4.95
Nickel (LME cash) (US\$/t)	14,947	15,498	37,809	28,506	13,294	19,357	23,942	19,335	16,380	15,168
Lead (LME Cash) (US\$/t) ^(f)	963	1,070	1,694	2,890	1,453	2,097	2,395	2,128	2,134	2,104
Zinc (LME Cash) (US\$/t) ^(g)	1,170	2,117	3,671	2,598	1,400	2,072	2,244	2,019	1,928	1,967
Silver (US\$/oz) ^(h)	6.95	9.23	12.72	15.40	12.91	16.85	28.61	33.26	28.97	20.57

(a) FY2011 onwards Platts low-vol hard coking coal Index FOB Australia – representative of high-quality hard coking coals. Pre-FY2011 Tex Reports Hard coking coal FOB Australia.

(b) Richards Bay Coal Terminal (RBCT) FOB (API 4).

(c) FY2012 onwards Platts PAX FOB Australia – market price assessment of calcined Metallurgical/Smelter Grade Alumina. Pre-FY2012 CRU Spot FOB Australia.

(d) CRU Bulk FerroAlloy HCFMn Western Europe DDP.

(e) FY2013 onwards Metal Bulletin manganese ore 44 per cent Mn CIF, FY2010 to FY2012 CRU CIF China import 43 per cent contained manganese. FY2007 to FY2009 CRU China spot import 45 per cent contained manganese. No credible index for CIF China pre-FY2007.

(f) Annual average of the Lead Cash Daily Official \$ per Tonne Monthly Average.

(g) Annual average of Zinc Cash LME Daily Official \$ per Tonne Monthly Average.

Table A5.6: South32's 10 year history of production volumes by Business

Total production volume										
	FY2005	FY2006	FY2007	FY2008	FY2009	FY2010	FY2011	FY2012	FY2013	FY2014
Metallurgical coal ('000 tonnes)										
Illawarra Metallurgical Coal	5,765	6,112	6,005	6,498	5,561	5,714	5,709	6,621	6,664	5,974
Energy coal ('000 tonnes)										
South Africa Energy Coal ^(a)	54,650	51,948	51,642	45,072	29,896	30,459	34,328	33,279	31,627	30,384
Illawarra Metallurgical Coal	486	902	881	767	712	821	1,175	1,305	1,278	1,539
Alumina ('000 tonnes)										
Worsley Alumina	2,813	2,763	2,956	3,035	2,924	3,054	2,902	2,917	3,675	3,916
Brazil Alumina	495	503	526	536	537	709	1,108	1,235	1,205	1,262
Aluminium ('000 tonnes)										
South Africa Aluminium	851	879	898	863	801	808	808	719	761	804
Mozal Aluminium	260	262	265	257	255	259	264	264	264	266
Brazil Aluminium	176	178	177	178	177	174	174	170	154	104
Manganese ores ('000 tonnes)										
Australia Manganese ^(b)	2,947	2,980	3,439	3,535	2,284	3,406	4,086	4,306	5,027	4,776
South Africa Manganese ^(b)	2,508	2,300	2,570	3,040	2,191	2,718	3,007	3,625	3,490	3,526
Manganese alloys ('000 tonnes)										
Australia Manganese ^(b)	263	218	239	262	212	219	267	198	234	269
South Africa Manganese ^{(b),(c)}	492	350	493	513	301	364	486	404	374	377
Nickel ('000 tonnes)										
Cerro Matoso	51	52	51	42	51	50	40	49	51	44
Lead ('000 tonnes)										
Cannington	282	266	211	252	227	245	243	239	213	187
Zinc ('000 tonnes)										
Cannington	53	69	46	61	55	63	61	55	56	58
Silver (k ounces)										
Cannington	44,030	38,447	29,105	35,485	33,367	37,276	35,225	34,208	31,062	25,161

(a) Shown on 100% basis. BHP Billiton interest in saleable production reduced to 90% during the second half of FY2013.

(b) Shown on 100% basis. BHP Billiton interest in saleable production is 60%, except Hotazel Manganese Mines which reduced to 44.4% for FY2010 onwards.

(c) Production includes Medium Carbon Ferro Manganese.

Table A5.7: South32's 10 year history of sales volumes by Business

Total Sales Volume	FY2005	FY2006	FY2007	FY2008	FY2009	FY2010	FY2011	FY2012	FY2013	FY2014
Metallurgical coal ('000 tonnes)										
Illawarra Metallurgical Coal	5,654	5,447	6,297	6,403	5,423	6,137	5,664	6,233	7,032	5,921
Energy coal ('000 tonnes)										
South Africa Energy Coal										
Export	20,477	21,638	20,665	15,584	8,646	10,531	12,381	14,106	13,935	13,298
Local utility	31,281	29,956	30,255	29,225	20,795	18,679	21,308	19,172	18,008	16,330
Inland	1,230	1,033	1,051	1,274	666	198	321	448	122	-
Illawarra Metallurgical Coal	346	935	931	840	718	731	1,325	1,098	1,410	1,623
Alumina ('000 tonnes)										
Worsley Alumina	2,856	2,675	2,939	2,981	2,958	3,046	2,862	2,928	3,677	3,864
Brazil Alumina	524	505	529	531	523	727	1,083	1,201	1,275	1,248
Aluminium ('000 tonnes)										
South Africa Aluminium										
Hillside, South Africa	682	691	693	687	707	691	652	616	667	708
Bayside, South Africa	170	165	194	177	96	110	127	97	105	96
Mozal Aluminium	264	259	260	258	270	259	277	265	264	276
Brazil Aluminium	176	178	171	181	182	180	174	163	164	104
Manganese ores ('000 tonnes)										
Australia Manganese	-	-	-	3,726	2,167	3,632	3,960	4,428	4,578	5,063
South Africa Manganese	-	-	-	2,976	1,995	3,133	3,051	3,451	3,491	3,480
Manganese alloys ('000 tonnes)										
Australia Manganese	-	-	-	237	181	257	258	229	227	276
South Africa Manganese	-	-	-	505	286	345	516	459	385	400
Nickel ('000 tonnes)										
Cerro Matoso	50	51	51	42	51	49	42	48	52	45
Lead ('000 tonnes)										
Cannington	285	265	214	241	234	246	242	237	219	189
Zinc ('000 tonnes)										
Cannington	53	65	45	56	55	65	57	55	57	62
Silver (k ounces)										
Cannington	44,051	38,627	30,330	34,636	34,796	37,178	34,690	33,259	30,258	26,160

This page has been intentionally left blank.

ANNEXURE 6

INDEPENDENT COMPETENT PERSONS' REPORTS

1. Boddington Bauxite Mine and Worsley Alumina Refinery – SRK Consulting
 2. South Africa Energy Coal – Xstract Mining Consultants
 3. Illawarra Coal – Runge Pincock Minarco
 4. Groote Eylandt Manganese Mine – CSA Global
 5. Hotazel Manganese Mines – CSA Global
 6. Cerro Matoso – SRK Consulting
 7. Cannington – Xstract Mining Consultants
-

High resolution versions of the Independent Competent Persons' Reports are available on BHP Billiton's website at www.bhpbilliton.com/demerger

This page has been intentionally left blank.

ANNEXURE 6

INDEPENDENT COMPETENT PERSONS' REPORTS

1. Boddington Bauxite Mine and Worsley Alumina Refinery – SRK Consulting
-

This page has been intentionally left blank.

A Competent Person's Report and Valuation on the Boddington Bauxite Mine and Worsley Alumina Refinery, Western Australia

Report Prepared for

BHP Billiton and South32 Limited



Report Prepared by



SRK Consulting (Australasia) Pty Ltd

BHP151

March 2015

A Competent Person's Report and Valuation on the Boddington Bauxite Mine and Worsley Alumina Refinery, Western Australia

BHP Billiton

Level 12, 171 Collins Street, Melbourne VIC 3000 Australia

and

South32 Limited

Level 20, Waterfront Place
1 Eagle Street, Brisbane Qld 4000 Australia

SRK Consulting (Australasia) Pty Ltd

Level 1, 10 Richardson Street, West Perth WA 6005 Australia

e-mail: perth@srk.com.au
website: srk.com.au
Tel: +61 08 9288 2000
Fax: +61 08 9288 2001

SRK Project Number BHP151

March 2015

Compiled by

Simon Hanrahan
Principal Consultant

Email: shanrahan@srk.com.au

Peer Reviewed by

Peter Fairfield
Principal Consultant

Authors:

Rod Brown, Ian de Bruyn, Sjoerd Duim, Luke Esprey, Dave Luppnow, Peter Smith, Anthony Stepcich, Simon Walsh, David Western, Ewan Wilson.

Executive Summary

Introduction

Background

SRK Consulting (Australasia) Pty Ltd (**SRK**) has been commissioned by South32 Limited (**South32**) and BHP Billiton, which includes South32 Limited, BHP Billiton Limited and BHP Billiton Plc (herein after also referred to as the **Company**) to prepare a Competent Person's Report, including a Valuation (**CPR**) on BHP Billiton Worsley Alumina Pty Ltd (**BWAPL**). BHP Billiton Limited and BHP Billiton Plc are public companies (ticker; **BHP** and **BLT**) listed on the London Stock Exchange (**LSE**), the Australian Stock Exchange (**ASX**), the New York Stock Exchange (**NYSE**) and the Johannesburg Stock Exchange (**JSE**) and have an 86% holding in the Boddington Bauxite Mine (**BBM**) and Worsley Alumina Refinery (**Worsley Refinery**) in a Joint Venture with Japan Alumina Associates (Australia) Pty Ltd (**Japan Alumina**) and Sojitz Alumina Pty Ltd (**Sojitz Alumina**). Both operations are situated in Western Australia, Australia.

BHP Billiton is considering the demerger of certain aluminium, coal, manganese, nickel and silver assets (Demerger); BWAPL is part of this consideration.

The demerged assets will be held by South32. It is currently intended that South32 will be listed on the ASX and JSE, and potentially on the Official List of the United Kingdom Listing Authority (**UKLA**) (together, the Relevant Listing Authorities).

This CPR presents the following key technical information as at the Effective Date (31 December 2014):

- Mineral Resource and Ore Reserve statements (the **2014 Statements (Worsley)**) reported in accordance with the terms and definitions of the JORC Code (defined below)
- Ore Reserve statements (the **2014 Statements (SRK Depleted)**) reported in accordance with the terms and definitions of the JORC Code (defined below) and used as the basis for the Valuation
- The associated Life of Mine plans (**LOMPs**) and associated technical and economic parameters (**TEPs**) included in the LOMPs
- A Technical Valuation for the BWAPL as at 31 December 2014.

Requirement and Reporting Standard

The reporting standard adopted for the reporting of the 2014 Statements (**SRK Depleted**) for BWAPL is that defined by the terms and definitions given in "***The 2012 Australasian Code for Reporting of Exploration Results, Mineral Resources and Ore Reserves (the JORC Code) as published by the Joint Ore Reserves Committee of The Australasian Institute of Mining and Metallurgy, Australian Institute of Geoscientists and Minerals Council of Australia***". The JORC Code is an internationally recognised reporting code as defined by the Combined Reserves International Reporting Standards Committee. SRK has been informed that the JORC Code is currently adopted by the Company in respect of Mineral Resource and Ore Reserve reporting.

The reporting standard adopted for the reporting of the Valuation for BWAPL is the "**Code for the Technical Assessment and Valuation of Mineral and Petroleum Assets and Securities for Independent Expert Reports: The VALMIN Code (2005 Edition)**", (the **VALMIN Code 2005**).

Reliance on SRK

The CPR is addressed to and may be relied upon by the Company, the Directors of the Company, the Shareholders of the Company and the Advisors of the Company in support of the Demerger, specifically in respect of compliance with the Requirements. SRK is responsible for this CPR and for all of the technical information in the prospectus released by the Company in connection with the Demerger and dated the same date as the CPR (the South32 Listing Documents) that has been extracted directly from this CPR. SRK declares that it has taken all reasonable care to ensure that this CPR and the technical information extracted here from and included in the South32 Listing Documents is, to the best of its knowledge, in accordance with the facts and contains no omission likely to affect its import.

SRK has no obligation or undertaking to advise any person of any development in relation to BWAPL which comes to its attention after the date of this CPR or to review, revise or update the CPR or opinion in respect of any such development occurring after the date of this CPR.

The Competent Person who has reviewed the Mineral Resources as reported by BHP Billiton is Mr Rodney Brown, BSc, MGAA, MAusIMM, MAIG, who is an employee of SRK. He is a Member of The AusIMM within the meaning of the JORC Code. Rod Brown is a mining geologist with over 25 years' experience in the mining industry and has been involved in the reporting of Mineral Resources on various properties internationally during the past 20 years.

The Competent Person who has reviewed the Ore Reserves as reported by BHP Billiton is Mr Sjoerd Duim, qualifications, MSc Eng (Mining Engineering), GDip (Engineering), who is an employee of SRK. He is a Member of The AusIMM. Sjoerd Duim is a mining engineer with over 32 years' experience in the mining industry and has been involved in the reporting of Ore Reserves on various properties internationally during the past 11 years.

The Competent Person and Competent Evaluator is Mr Anthony Stepcich, MSc (Mineral Economics), BEng (Mining), Grad Dip (Finance & Investment), Dip (Technical Analysis), MAusIMM(CP), who is an employee of SRK. Anthony Stepcich is a mining engineer with over 20 years' experience in the mining and metals industry and has been involved in the preparation of Competent Persons' Report comprising technical valuations on various mineral assets internationally during the past nine years. Anthony Stepcich assumes the responsibility for the estimates presented and has the relevant experience to be considered an Expert under the VALMIN guidelines.

Whilst SRK has exercised all due care in reviewing the supplied information, SRK does not accept responsibility for finding any errors or omissions contained therein and disclaims liability for any consequences of such errors or omissions.

SRK's assessment of BWAPL's Mineral Resources and Ore Reserves, TEP forecasts and the Valuation for BWAPL is based on information provided by the Company and BWAPL throughout the course of SRK's investigations, which in turn reflect various technical economic conditions prevailing at the date of this report. In particular, the Ore Reserves, the TEPs and the Valuation for BWAPL are based on expectations regarding the commodity prices and exchange rates prevailing at the Effective Date of this CPR. These TEPs can change significantly over relatively short periods of time. Should these change materially, the TEPs could be materially different in these changed circumstances. This CPR specifically excludes all aspects of legal issues, marketing, commercial and financing matters, insurance, land titles and usage agreements, and any other agreements and/or contracts that BWAPL may have entered into.

This CPR includes technical information, which requires subsequent calculations to derive subtotals, totals and weighted averages. Such calculations may involve a degree of rounding and consequently introduce an error. Where such errors occur, SRK does not consider them to be material.

Review process

SRK has conducted a review (which specifically excludes independent verification by means of re-calculation) and assessment of all material technical issues likely to influence the future performance of BWAPL and the resulting TEPs which included the following:

- Inspection visits to the BWAPL's mining and processing facilities and associated infrastructure undertaken during October 2014
- Enquiry of key mine and head office personnel during Q4 2014 in respect of the BWAPL operation, the 2014 Statements (SRK Depleted), the TEPs and other related matters
- Examination of historical information for the financial reporting periods ended 30 June 2014
- Review of the 2014 Statements (Worsley) for BWAPL – whilst SRK has not re-estimated the Mineral Resources and Ore Reserves, SRK has performed all necessary validation and verification procedures deemed appropriate in order to place reliance on such information
- Reporting of the 2014 Statements (SRK Depleted) based on Ore Reserve depletion adjustments to the 2014 Statements (Worsley)
- Examination, review and where appropriate modification of technical studies and LOMPs completed in respect of BWAPL and all conclusions and recommendations drawn therefrom
- Valuation of the BBM and Worsley Refinery.

SRK has also assessed the reasonableness of the macro-economic and commodity price assumptions as currently assumed in the projections for inclusion in the 2014 Statements (SRK Depleted), the TEPs and the Valuation for BBM and Worsley Refinery.

Overview of the Boddington Bauxite Mine and the Worsley Alumina Refinery

Introduction

BWAPL is an integrated bauxite mining/ alumina refining operation that includes rail and port facilities. The mine is located some 123 km south east of Perth and the refinery is situated 55 km northeast of the port of Bunbury, Western Australia. The operation opened in 1983 and the Boddington Bauxite Mine supplies bauxite ore to the Worsley Alumina Refinery via a 51 km-long conveying system. Capacity has increased from the original 1 Mtpa of alumina production to the current nameplate capacity of 4.6 Mtpa through a series of expansions. BWAPL is the operator and ownership is held within a Joint Venture (BHP Billiton 86%, Sojitz Alumina 4% and Japan Alumina 10%). BHP Billiton's share of BWAPL's FY2014 production was 3.9 Mt of alumina.

Title and Rights

The key mining lease for the project (M70/258SA) was granted to the Worsley Joint Venture (WJV) partners on 16 August 1983 (expiry 15 August 2025). M70/258SA was granted through the *Alumina Refinery (Worsley) Agreement Act 1973* Act and covers both State Forest and privately owned land. WJV is also the holder of other supporting Mining Leases granted under the *Mining Act 1978*. WJV also has sub-leases with the Boddington Gold Mine for use of several of these mining leases. WJV also holds a sub-lease of two parts of ML1SA held by Alcoa of Australia Limited. WJV holds several General Purpose Leases for the construction of the Campsite for the project expansion. All these General Purpose Leases are current and will expire on 31 August 2019. WJV also has several Crown Leases for the Overland Conveyor and for the Refinery. The Bunbury Port Facility is situated on ground that is leased through the Bunbury Port Authority.

Geology

The BWAPL deposits are located on the eastern flanks of the Darling Ranges approximately 100 km south-southeast of Perth in the south west of Western Australia. The bauxites have developed on the exposed Achaean basement of the Western Gneiss Terrane, which is located on the western edge of the Yilgarn Block. In the project area, the Western Gneiss Terrane is predominantly composed of granitic gneisses and migmatites, as well as the greenstones of the Saddleback Greenstone Belt. The northerly trending greenstone belt is approximately 43 km long and 5 - 12 km wide, and consists of sequences of mafic to felsic volcanics, pyroclastics, and sediments that have undergone greenschist facies metamorphism. The gneisses and greenstones have been intruded by relatively undeformed granites, and subsequently by numerous northerly trending doleritic dykes that range in thickness from 1 to 200 m. The dominant structural feature in the region is the Darling Fault, which forms the western boundary of the Western Gneiss Terrane.

In the project area, bauxite exists as irregular lenses, locally referred to as pods, within the remnant laterite. The pods are generally elongated in the NNW-SSE direction and vary in size from 1 to 200 ha. The majority of the pods contain approximately 2 million tonnes (Mt) of bauxite. The pods are generally confined to slopes where the gradient is between 5° and 10°. In steeper areas, the lateritic cover has often been removed by erosion.

Mineral Reserves and Ore Reserves

As at 31 December 2014; BWAPL had Ore Reserves of 288.5 Mt grading 31.0% available alumina ($A\cdot Al_2O_3$). Mineral Resources are reported inclusive of Ore Reserves at a total of 1,131 Mt grading 31.4% $A\cdot Al_2O_3$.

Mining operation

BWAPL mines the bauxite by shallow open pit mining methods from a number of open pits. The bauxite occurs in pods, close to the surface, with an ore thickness of up to 10 m.

Typically, mining operations will be from three to four active open pits simultaneously, in order to be able to blend the required Al_2O_3 feed grade for the Worsley Refinery. There are currently two mining areas at BBM, the Saddleback Mining Envelope (SME) and the Marradong Mining Envelope (MME).

The crushed bauxite product, after primary crushing (at Marradong or Saddleback) and secondary crushing at the Saddleback area, is transported to the Worsley Refinery near Collie, via a 2-flight cable belt overland bauxite conveyor (OBC) with a total length of 51 km. The bauxite is stockpiled at the refinery.

Alumina refinery

Worsley Refinery has been operating since 1984. In the 30 years since operations commenced, the capacity has increased from the original 1 million tonnes per annum (Mtpa) of alumina production to the current nameplate capacity of 4.6 Mtpa through a series of expansions. The most recent expansion in 2012 makes it one of the largest bauxite mining and alumina refinery operations in the world.

Bauxite is refined to alumina using the Bayer process. This process relies on the principal that aluminium is an element with a high solubility in alkaline solution, whereas most of the other elements in bauxite ore (except silica) are not. The process uses sodium hydroxide to digest (leach) alumina from the bauxite. The liquor containing dissolved alumina is separated (clarified) from residual solids before being precipitated as hydrated alumina before being calcined at high temperature to drive off chemically bound "waters of hydration" to produce the final alumina product.

Tailings storage facilities

BWAPL currently operates five bauxite residue disposal areas (BRDAs) at its refinery site. BWAPL currently produces ~4.6 Mtpa of alumina and as a result produces ~2.24 t of bauxite residue for each ton of alumina i.e. ~10.1 Mt bauxite residue is produced annually.

Environmental liabilities

In 2014, the Closure Plan was revised and the cost model updated as part of the biannual update. The current closure cost (June 2014) has an undiscounted closure cost of A\$2,094M with an accounting provision estimated at A\$218M.

Concluding remarks

Mineral Resources and Ore Reserves

The 2014 Statements (SRK Depleted) for BWAPL are summarised in Table ES-1 and Table ES-2.

SRK concludes that the Mineral Resources and Ore Reserves as stated herein are reported in accordance with the terms and definitions of the JORC Code (2012). Mineral Resources are reported inclusive of Ore Reserves.

Table ES-1: Mineral Resource as at 31 December 2014 (inclusive of Reserves)

Ore type	Measured Resource			Indicated Resource			Inferred Resource			Total Resource			BHPB interest
	Mdt	A.Al ₂ O ₃ ⁽¹⁾	RxSiO ₂ ⁽²⁾	Mdt	A.Al ₂ O ₃ ⁽¹⁾	RxSiO ₂ ⁽²⁾	Mdt	A.Al ₂ O ₃ ⁽¹⁾	RxSiO ₂ ⁽²⁾	Mdt	A.Al ₂ O ₃ ⁽¹⁾	RxSiO ₂ ⁽²⁾	
Laterite	358	31.1	1.5	355	32	2.3	418	31.2	2.6	1,131	31.4	2.2	86%

(1) A.Al₂O₃ – available alumina reported at Worsley Design Indicated Extraction basis (WDIE)

(2) RxSiO₂ – reactive silica reported at Worsley Design Indicated Extraction basis (WDIE)

Table ES-2: Ore Reserves as at 31 December 2014

31 December 2014	Proved Reserve			Probable Reserve			Total Ore Reserve		
	Mass	Grade	Grade	Mass	Grade	Grade	Mass	Grade	Grade
	Mdt	AAI ₂ O ₃	RXSiO ₂	Mdt	AAI ₂ O ₃	RXSiO ₂	Mdt	AAI ₂ O ₃	RXSiO ₂
Granite derived	52	31.3	2.3	2	31.2	2.5	54	31.3	2.3
Greenstone derived	214	30.1	1.4	20	30.2	1.6	234.5	30.9	1.4
Total	266	31.1	1.6	22	30.3	1.7	288	31.0	1.6

Valuation

The preferred Technical Value based on BWAPL's Ore Reserves is US\$1.245 billion (86% holding).

This value is derived from the net present value of the after tax cash flows as determined in the financial model, assuming consensus market forecasts and a long term Alumina price of US\$350/t.

This valuation is reflective of BWAPL, based on SRK's view in relation to Ore Reserves only. It is important to emphasise that this value does not represent the value of the Ore Reserves in the ground in isolation, but rather, incorporates the value of all of ungeared net assets contributing to the project based on an Ore Reserve production profile. For example, at BWAPL, this includes the value of the refinery, conveyors, truck fleet, port infrastructure as well as the mine.

Table of Contents

Executive Summary	i
1 Introduction	1
1.1 Background	1
1.2 Reporting Compliance, Reporting Standard and Reliance	2
1.2.1 Reporting Compliance	2
1.2.2 Reporting Standard	2
1.2.3 Reliance on SRK	2
1.3 Base Technical Information Date, Effective Date and Publication Date	3
1.4 Verification and Validation	3
1.5 Limitations, Reliance on Information, Declaration, Consent and Cautionary Statements	4
1.5.1 Limitations	4
1.5.2 Reliance on information	4
1.5.3 Declaration	5
1.5.4 Consent	5
1.6 Qualifications of Consultants, Competent Persons and Competent Evaluators	6
2 Overview	8
2.1 Property description	8
2.2 Property rights	8
2.3 Environmental Permits and Approvals	9
3 Geology and Resource	11
3.1 Mineral Resource	11
3.2 Mineral Resource (SRK Depleted)	12
3.3 Geological Setting	14
3.3.1 Regional Geology	14
3.3.2 Bauxite characteristics	15
3.4 Data acquisition	16
3.4.1 Exploration history	16
3.4.2 Sample spacing and collection	17
3.4.3 Sample preparation and analysis	17
3.4.4 Density data	19
3.4.5 Survey	19
3.4.6 Quality Assurance data	19
3.5 Resource estimation	20
3.5.1 Geology Model	20
3.5.2 Volume Model	21
3.5.3 Estimation datasets	22
3.5.4 Exploratory data analysis	22
3.5.5 Grade estimation	22

3.6	Resource classification	24
3.7	Model validation	24
3.8	Audits	28
3.9	Reconciliations	28
3.10	Resource potential	29
3.11	Summary comments	29
4	Ore Reserve	32
4.1	Introduction	32
4.2	Optimisation parameters	32
4.3	Modifying factors	33
4.4	Ore Reserve statement	34
4.5	Historical Ore Reserve statements	35
4.6	Ore Reserve statements (SRK Depleted)	36
5	Geotechnical Engineering	38
5.1	Settings	38
5.2	Slope stability	38
5.3	Summary comments	38
6	Hydrology and Hydrogeology	39
6.1	Hydrology	39
6.1.1	Physical setting	39
6.1.2	Water supply	39
6.1.3	Water balance	41
6.1.4	Surface water supply licences	41
6.1.5	Data monitoring - Surface water	41
6.1.6	Surface water - Emergency response plans	42
6.1.7	Summary comments	42
6.2	Hydrogeology	42
6.2.1	Hydrogeological environment	42
6.2.2	Dewatering status	43
6.2.3	Water management	43
6.2.4	Operating and capital expenditure	43
6.3	Summary comments	44
7	Mining Engineering	45
7.1	Introduction	45
7.2	Mine design and Mining method	46
7.2.1	Mining method	46
7.2.2	Mine design	49
7.2.3	Waste dumps	49
7.2.4	Ore stockpiles	49
7.2.5	Mining fleet	50
7.2.6	Mining owner/contractor	50

7.2.7	Marradong Mining Envelope infrastructure	50
7.2.8	Saddleback Mining Envelope infrastructure	50
7.2.9	Overland Bauxite Conveyor	51
7.3	Life of Mine schedule	51
7.5	5-year plan – FY2015 - FY2019.....	53
8	Worsley Alumina Refinery	56
8.1	Process description.....	56
8.1.1	Digestion.....	56
8.1.2	Clarification.....	57
8.1.3	Precipitation.....	58
8.2	Metallurgical testwork.....	61
8.3	Product quality	61
8.4	Historical production.....	61
8.4.1	Alumina production.....	61
8.4.2	Available alumina grade	62
8.6	Raw materials	63
8.7	Operating expenditure	64
8.9	Costs summary	66
8.10	Risks and opportunities.....	66
8.11	Summary comments	67
9	Infrastructure	68
9.1	Access.....	68
9.2	Rail	69
9.3	Power and natural gas	69
9.4	Water.....	70
9.5	Communications	70
9.6	Infrastructure buildings.....	70
9.7	Port.....	70
9.8	Operating expenditure	72
9.9	Capital expenditure	72
9.10	Summary comments	72
10	Tailings Storage Facilities	73
10.1	Introduction	73
10.2	Tailings storage facilities design and construction.....	73
10.3	Tailings storage facilities construction and operation	74
10.4	Oxalate storage.....	75
10.5	Capital and Operating expenditure	76
10.6	Summary comments	76
11	Human Resources	77
11.1	Introduction	77
11.2	Operating structure	77

11.3 Recruitment.....	77
11.4 Industrial relations.....	78
11.5 Summary comments.....	78
12 Occupational Health and Safety.....	79
12.1 OHS management.....	79
12.2 Occupational health and major exposures.....	79
12.3 OHS performance.....	79
12.4 Summary comments.....	80
13 Environmental.....	81
13.1 Introduction.....	81
13.2 Basis of Environmental Review.....	81
13.3 Environmental Setting.....	81
13.4 Environmental Management.....	82
13.5 Environmental Issues.....	83
13.5.1 Mine and Overland Conveyor.....	83
13.5.2 Refinery.....	84
13.5.3 Port facilities.....	84
13.6 Environmental compliance.....	85
13.7 Closure Plan.....	86
13.8 Closure Cost estimate.....	87
13.9 Operating expenditure.....	88
13.10 Capital expenditure.....	88
13.11 Environmental liabilities.....	88
13.12 Summary comments.....	89
14 Valuation – Methodology.....	90
14.1 Introduction.....	90
14.2 Reporting standard.....	90
14.3 Valuation method.....	90
14.4 Materiality.....	91
15 Valuation - Value.....	92
15.1 Commodity Prices & Macro Economics.....	92
15.1.1 Introduction.....	92
15.1.2 Commodity price.....	92
15.2 Macro-economics.....	93
15.2.1 Recent and current market conditions.....	93
15.2.2 Supply issues.....	94
15.2.3 Demand issues.....	94
15.2.4 Supply/ demand balance effect on price.....	94
15.3 Financial model structure and Inputs.....	95
15.3.1 Introduction.....	95
15.3.2 Model assumptions.....	95

15.4	Financial model results	96
15.5	Benchmarking	99
15.5.1	Introduction.....	99
15.5.2	Definitions.....	100
15.5.3	2015 Cash cost comparison.....	100
15.6	Discounted cash flow result	102
15.7	Sensitivity analysis	102
15.8	Comparable transaction analysis.....	103
15.9	Risks and opportunities.....	103
15.10	Summary comments	104
16	Concluding Remarks.....	105
16.1	Introduction	105
16.2	Mineral Resources and Ore Reserves.....	105
16.3	Valuation	105
16.4	Principal issues	105

List of Tables

Table 3-1:	Mineral Resource as at 30 June 2014 (inclusive of Reserves).....	11
Table 3-2:	Mineral Resources as at 31 December 2014 (inclusive of Reserves).....	12
Table 3-3:	Summary of bauxite deposits.....	14
Table 3-4:	Drillhole quantities used for Resource Estimation	17
Table 3-5:	Summary of estimation parameters	23
Table 3-6:	Reconciliation summary.....	29
Table 4-1:	Summary Ore Reserve statement – 30 June 2014	34
Table 4-2:	Ore Reserve statement – 30 June 2014 (by area)	34
Table 4-3:	Ore Reserve statement - 30 June 2013.....	35
Table 4-4:	Ore Reserve statement - 30 June 2012.....	35
Table 4-5:	Ore Reserve statement - 30 June 2011.....	35
Table 4-6:	Ore Reserve statement (SRK Depleted) – 31 December 2014.....	36
Table 6-1:	Current annual maintenance and monitoring operational costs	43
Table 7-1:	Boddington Bauxite Mine – primary mining fleet	50
Table 7-2:	Boddington Bauxite Mine – life of mine bauxite production profile (as per valuation model)	52
Table 7-3:	Boddington Bauxite Mine – historical mining physicals	53
Table 7-4:	BBM 5YP – FY2015 to FY2019 (inclusive) – (Interim 5YP – July 2014).....	54
Table 7-5:	BBM Indicative 5YP - unit operating cost.....	54
Table 7-6:	Annual unit operating costs for the Boddington Bauxite Mine	54
Table 7-7:	BBM – Mining capital expenditure	55
Table 8-1:	Forecast production	63
Table 8-2:	Historical & forecast cash costs of the Refinery	64
Table 8-3:	Historical & forecast Refinery sustaining & major projects capital costs	66

Table 10-1: Budgeted capital	76
Table 11-1: Worsley Alumina historical & forecast headcount.....	77
Table 12-1: Historical & forecast summary safety statistics (including E&G Expansion)	80
Table 13-1: Summary of 2014 closure cost estimate (Draft conceptual closure plan, 2014)	87
Table 15-1: Consensus market forecasts	92
Table 15-2: Discount rate calculation	96
Table 15-3: Valuation model (inputs and outputs)	96
Table 15-4: Valuation summary	102
Table 15-5: Sensitivity analysis	102
Table 16-1: Mineral Resource as at 31 December 2014 (inclusive of Reserves).....	105
Table 16-2: Ore Reserves as at 31 December 2014	105

List of Figures

Figure 3-1: BWAPL Resource regions	13
Figure 3-2: Typical profile of Darling Range bauxite	16
Figure 3-3: Sample preparation and analysis flowchart	18
Figure 3-4: Stratigraphic surfaces folded to topography	21
Figure 3-5: Example Greenstone swath plot – Saddleback bauxite zone (Ore zone)	26
Figure 3-6: Example Granite swath plot – Hotham South bauxite zone	27
Figure 3-7: Predicted production based on current Resource classification	29
Figure 4-1: Boddington Bauxite Mine – Primary bauxite area (dark blue line).....	32
Figure 7-1: Boddington Bauxite Mine tenement areas	45
Figure 7-2: Boddington Bauxite Mine – sequence of mining operations.....	46
Figure 7-3: Edge of original State Forest area adjacent to an active bauxite mining block - Saddleback area	47
Figure 7-4: Secondary Overburden removal by small backhoe excavators – Saddleback area	47
Figure 7-5: Loading ore into a 145 tonne haul truck – Saddleback area	48
Figure 7-6: Backfilled mined out area with topsoil and reclamation area in background –Saddleback area.....	48
Figure 7-7: Rehabilitated and reforested area in background – Saddleback area.....	49
Figure 8-1: Worsley Alumina Refinery.....	56
Figure 8-2: Bauxite stockpiles at Worsley Alumina Refinery.....	57
Figure 8-3: Digestion and clarification - summary process flow diagram.....	58
Figure 8-4: Precipitation and calcination - summary process flow diagram	60
Figure 8-5: Worsley input production.....	62
Figure 8-6: Caustic usage	63
Figure 8-7: Energy usage	64
Figure 9-1: Worsley Alumina location.....	68
Figure 9-2: Worsley Alumina port facility (right side).....	71
Figure 10-1: Plan of BRDAs and dams	73
Figure 10-2: Typical embankment cross-section.....	74
Figure 15-1: Consensus Alumina price forecast	93

Figure 15-2: Historical Alumina price.....	95
Figure 15-3: Alumina production profile	97
Figure 15-4: Operating cost estimate	97
Figure 15-5: Capital cost estimate.....	98
Figure 15-6: Taxes & royalties estimate	98
Figure 15-7: Revenue estimate	99
Figure 15-8: ATCF estimate	99
Figure 15-9: LOM cash cost profile	101
Figure 15-10: C1 Alumina cash costs.....	101
Figure 15-11: Sensitivity analysis	103
Figure 15-12: NPV versus discount rate.....	103

1 Introduction

1.1 Background

SRK Consulting (Australasia) Pty Ltd (**SRK**) has been commissioned by South32 Limited (**South32**) and BHP Billiton, which includes South32 Limited, BHP Billiton Limited and BHP Billiton Plc (herein after also referred to as the **Company**) to prepare a Competent Person's Report, including a Valuation (**CPR**) on BHP Billiton Worsley Alumina Pty Ltd (**BWAPL**). BHP Billiton Limited and BHP Billiton Plc are public companies (ticker; **BHP** and **BLT**) listed on the London Stock Exchange (**LSE**), the Australian Stock Exchange (**ASX**), the New York Stock Exchange (**NYSE**) and the Johannesburg Stock Exchange (**JSE**) and have an 86% holding in the Boddington Bauxite Mine (**BBM**) and Worsley Alumina Refinery (**Worsley Refinery**) in a Joint Venture with Japan Alumina Associates (Australia) Pty Ltd (**Japan Alumina**) and Sojitz Alumina Pty Ltd (**Sojitz Alumina**). Both operations are situated in Western Australia, Australia.

BHP Billiton is considering the demerger of certain aluminium, coal, manganese, nickel and silver assets (Demerger); BWAPL is part of this consideration.

The demerged assets will be held by South32. It is currently intended that South32 will be listed on the ASX and JSE, and potentially on the Official List of the United Kingdom Listing Authority (**UKLA**) (together, the Relevant Listing Authorities).

The BWAPL operations are located in the south west of Western Australia (WA). Bauxite mining takes place in the State Forest on the eastern edge of the Darling Range, near Boddington, using shallow open pit mining methods, from a number of open pits, over extended areas.

The main tenement lease areas are the State Agreement Mining Lease 258SA (ML258SA) and a sublease area from Alcoa of Australia Ltd (Alcoa) of a portion of State Agreement Mining Lease 1SA (ML1SA). The Primary Bauxite Area (PBA) is the area where State Government environmental approval to mine bauxite has been granted. Currently, all mining operations take place inside the PBA limits. The majority of the FY2014 mining operations are in the Marradong and Saddleback areas.

BWAPL is the operator and ownership is held within a Joint Venture (BHP Billiton 86%, Sojitz Alumina 4% and Japan Alumina 10%). BHP Billiton's share of BWAPL FY2014 production was 3.9 Mt of alumina.

The Company has informed SRK that the mineral assets (the **Mineral Assets**) being the focus of the CPR are limited to the established BBM (the current Mineral Resources and Ore Reserves) and Worsley Alumina Refinery (Worsley Refinery), including the Bunbury Port Facility. The Company has advised SRK that it is not appropriate to report on any other Mineral Assets, i.e. exploration.

As at 31 December 2014, SRK, based on depletion adjustments alone, reports the following in respect of BWAPL (on a 100% basis):

- Ore Reserves of approximately 288.5 Mt grading 31.0%Al₂O₃
- Measured and Indicated Mineral Resources of approximately 1,131 Mt grading 31.4%Al₂O₃.

This CPR presents the following key technical information as at the Effective Date (defined below):

- Mineral Resource and Ore Reserve statements (the **2014 Statements (Worsley)**) reported in accordance with the terms and definitions of the JORC Code (defined below)
- Ore Reserve statements (the **2014 Statements (SRK Depleted)**) reported in accordance with the terms and definitions of the JORC Code (defined below) and used as the basis for the Valuation

- The associated Life of Mine plans (**LOMPs**) and associated technical and economic parameters (**TEPs**) included in the LOMPs
- A Technical Valuation for the BWAPL as at 31 December 2014.

Certain units of measurements and technical terms defined in the JORC Code (defined below under Section 1.2.2) are defined in the list of abbreviations included at the end of this CPR.

Unless otherwise stated, all statistics presented are on a 100% basis.

1.2 Reporting Compliance, Reporting Standard and Reliance

1.2.1 Reporting Compliance

SRK has been informed that the Company is required to comply with the following requirements which together comprise the “**Requirements**” – European Securities and Markets Authority (**ESMA**); ESMA/2013/319.

1.2.2 Reporting Standard

The reporting standard adopted for the reporting of the 2014 Statements (**SRK Depleted**) for BWAPL is that defined by the terms and definitions given in “*The 2012 Australasian Code for Reporting of Exploration Results, Mineral Resources and Ore Reserves (the JORC Code) as published by the Joint Ore Reserves Committee of The Australasian Institute of Mining and Metallurgy, Australian Institute of Geoscientists and Minerals Council of Australia*”. The JORC Code is an internationally recognised reporting code as defined by the Combined Reserves International Reporting Standards Committee. SRK has been informed that the JORC Code is currently adopted by the Company in respect of Mineral Resource and Ore Reserve reporting.

The reporting standard adopted for the reporting of the Valuation for BWAPL is the “Code for the Technical Assessment and Valuation of Mineral and Petroleum Assets and Securities for Independent Expert Reports: The VALMIN Code (2005 Edition)”, (the VALMIN Code 2005).

1.2.3 Reliance on SRK

The CPR is addressed to and may be relied upon by the Company, the Directors of the Company, the Shareholders of the Company, and the Advisors of the Company in support of the Demerger, specifically in respect of compliance with the Requirements. Accordingly, SRK agrees that the CPR may be made available to and relied upon by the Company’s various financial, legal and accounting advisors (the **Advisors**). SRK is responsible for this CPR and for all of the technical information in the prospectus released by the Company in connection with the Demerger and dated the same date as the CPR (the **South32 Listing Documents**) that has been extracted directly from this CPR. SRK declares that it has taken all reasonable care to ensure that this CPR and the technical information extracted here from and included in the South32 Listing Documents is, to the best of its knowledge, in accordance with the facts and contains no omission likely to affect its import.

SRK believes that its opinion must be considered as a whole and that selecting portions of the analysis or factors considered by it, without considering all factors and analyses together, could create a misleading view of the process underlying the opinions presented in this CPR. The preparation of a CPR is a complex process and does not lend itself to partial analysis or summary.

SRK has no obligation or undertaking to advise any person of any development in relation to BWAPL which comes to its attention after the date of this CPR or to review, revise or update the CPR or opinion in respect of any such development occurring after the date of this CPR.

1.3 Base Technical Information Date, Effective Date and Publication Date

The effective date of the CPR is 31 December 2014 (the **Effective Date**). The 2014 Statements (SRK Depleted) and the Valuation have been prepared as at the Effective Date in reliance on the following:

- “2014 Statements (Worsley)” as declared and published by BHP Billiton in their annual report for the year ending 30 June 2014 (the **Base Technical Information Date**)
- Adjustments made to the 2014 Mineral Resource and Ore Reserve Statements (Worsley) by SRK having conducted, *inter alia*, depletion and historical performance analyses and a review of any additional information dated after the Base Technical Information Date published by the Company.

As advised by the Company, as at the publication date of this CPR (the **Publication Date**), no material change has occurred since the Effective Date. This includes, *inter alia*, no material change to the 2014 Statements (SRK Depleted) or to the Valuation for BWAPL.

1.4 Verification and Validation

SRK has conducted a review (which specifically excludes independent verification by means of re-calculation) and assessment of all material technical issues likely to influence the future performance of BWAPL and the resulting TEPs which included the following:

- Inspection visits to the BWAPL’s mining and processing facilities and associated infrastructure undertaken by Rodney Brown, Sjoerd Duim, Simon Walsh and Peter Smith for a total of two days during the week commencing 20 October 2014
- Enquiry of key mine and head office personnel during Q4 2014 in respect of the BWAPL operation, the 2014 Statements (SRK Depleted), the TEPs and other related matters
- Examination of historical information for the financial reporting periods ended 30 June 2014
- Review of the 2014 Statements (Worsley) for BWAPL – whilst SRK has not re-estimated the Mineral Resources and Ore Reserves, SRK has performed all necessary validation and verification procedures deemed appropriate in order to place reliance on such information
- Reporting of the 2014 Statements (SRK Depleted) based on Ore Reserve depletion adjustments to the 2014 Statements (Worsley)
- Examination, review and where appropriate modification of technical studies and LOMPs completed in respect of BWAPL and all conclusions and recommendations drawn therefrom
- Valuation of the Boddington Bauxite Mine and Worsley Refinery.

SRK has also assessed the reasonableness of the macro-economic and commodity price assumptions as currently assumed in the projections for inclusion in the 2014 Statements (SRK Depleted), the TEPs and the Valuation for BBM and Worsley Refinery.

Accordingly, the Company and BWAPL have provided technical data to SRK for the purpose of this review and inclusion in the CPR. SRK confirms that it has performed all necessary validation and verification procedures deemed necessary and/or appropriate by SRK in order to place an appropriate level of reliance on such technical information.

In presenting the 2014 Statements (SRK Depleted), the TEPs and the Valuation for BBM and Worsley Refinery in this CPR, the following applies:

- Measured and Indicated Mineral Resources are inclusive of those Mineral Resources modified to produce Ore Reserves, i.e. they are reported on an “inclusive basis”

- Commodity long-term price (**LTP**) assumptions of US\$350/t Alumina for the valuation of Ore Reserves
- Consensus market forecasts (**CMF**) which currently project a range of US\$340-335/t Alumina
- SRK has not included any consideration of Inferred Mineral Resources in determining the Valuation for BBM and Worsley Refinery. The exclusion of these sources of potential value, as well as the exclusion of a premium or discount related to market, strategic or other considerations means that the Valuation does not reflect a Fair Market Value.

1.5 Limitations, Reliance on Information, Declaration, Consent and Cautionary Statements

1.5.1 Limitations

Ore Reserve estimates are based on many factors, including in this case, data with respect to drilling and sampling. Ore Reserves are derived from estimates of future technical factors, operating and capital expenditures, product prices and the exchange rate between the various currencies and the United States dollar (US\$). The Ore Reserve estimates contained in this report should not be interpreted as assurances of the economic life of BWAPL. As Ore Reserves are estimates based on the factors and assumptions described herein, future Ore Reserve estimates may need to be revised. For example, if production costs increase or product prices decrease, a portion of the current Mineral Resources, from which the Ore Reserves are derived, may become uneconomical to recover and would therefore result in lower estimated Ore Reserves. Furthermore, should any of the assumed factors change, the 2014 Statements (SRK Depleted), the TEPs and the Valuation for BWAPL as reported herein, may need to be revised and may well result in lower estimates. The 2014 Statements (SRK Depleted), the TEPs and the Valuation for BBM and Worsley Refinery include a number of forward-looking statements. These forward-looking statements are estimates and involve a number of risks and uncertainties that could cause, actual results, to differ materially.

The achievability of the projections of TEPs as included in this CPR and incorporated into the Valuation for BWAPL is neither warranted nor guaranteed by SRK. The projections as presented and discussed herein have been proposed by BWAPL's management and adjusted where appropriate by SRK, and cannot be assured; they are necessarily based on economic assumptions, many of which are beyond the control of the Company and BWAPL. Future cash flows and profits derived from such forecasts are inherently uncertain and actual results may be significantly more or less favourable. Unless otherwise expressly stated, all the opinions and conclusions expressed in this CPR are those of SRK.

1.5.2 Reliance on information

SRK has relied upon the accuracy and completeness of technical, financial and legal information and data:

- Furnished by or through the Company, including information and data originating with BWAPL
- In respect of all aspects relating to BWAPL, publicly available information published by BHP Billiton from time to time, including and not limited to any Mineral Resource and Ore Reserve statements and any technical studies contained in such information or data.

The Company has confirmed to SRK that, to its knowledge, the information provided by it (when provided) was complete and not incorrect or misleading in any material respect. SRK has no reason to believe that any material facts have been withheld.

Whilst SRK has exercised all due care in reviewing the supplied information, SRK does not accept responsibility for finding any errors or omissions contained therein and disclaims liability for any consequences of such errors or omissions.

SRK's assessment of BWAPL's Mineral Resources and Ore Reserves, TEP forecasts and the Valuation for BWAPL is based on information provided by the Company and BWAPL throughout the course of SRK's investigations, which in turn reflect various technical economic conditions prevailing at the date of this report. In particular, the Ore Reserves, the TEPs and the Valuation for BWAPL are based on expectations regarding the commodity prices and exchange rates prevailing at the Effective Date of this CPR. These TEPs can change significantly over relatively short periods of time. Should these change materially, the TEPs could be materially different in these changed circumstances. This CPR specifically excludes all aspects of legal issues, marketing, commercial and financing matters, insurance, land titles and usage agreements, and any other agreements and/or contracts that BWAPL may have entered into.

This CPR includes technical information, which requires subsequent calculations to derive subtotals, totals and weighted averages. Such calculations may involve a degree of rounding and consequently introduce an error. Where such errors occur, SRK does not consider them to be material.

1.5.3 Declaration

SRK will receive a fee for the preparation of this report in accordance with normal professional consulting practice. This fee is not dependent on the findings of this CPR and SRK will receive no other benefit for the preparation of this CPR. SRK does not have any pecuniary or other interests that could reasonably be regarded as capable of affecting its ability to provide an unbiased opinion in relation to the Ore Reserves, the TEPs, the Valuation for BWAPL and the projections and assumptions included in the various technical studies completed by BWAPL, opined upon by SRK and reported herein. Neither SRK, the Competent Persons (identified under Section 1.6) nor the Competent Evaluator (identified under Section 1.6) who are responsible for authoring this CPR, have had within the previous two years, any shareholding in the Company, (except as detailed below), or any other economic or beneficial interest (present or contingent) in any of the assets being reported on. SRK is not a group, holding or associated company of the Company. None of SRK's principals or officers are officers or proposed officers of any group, holding or associated company of the Company. Further, no Competent Person or Competent Evaluator involved in the preparation of this CPR is an officer, employee or proposed officer of the Company or any group, holding or associated company of the Company.

Consequently, SRK, the Competent Persons and Competent Evaluator and the Directors of SRK consider themselves to be independent of the Company, its directors, senior management and Advisors. In this CPR, SRK provides assurances to the Board of Directors of the Company, in compliance with the Requirements and specifically the Reporting Standard that the Ore Reserves, the TEPs, including production profiles, operating expenditures and capital expenditures of BWAPL as provided to SRK by the Company and reviewed, and where appropriate, modified by SRK are reasonable, given the information currently available.

SRK declares that at the time of reporting, the following Competent Persons held personal shareholdings in BHP Billiton:

Rodney Brown: 1,100 shares.

1.5.4 Consent

SRK has given and has not withdrawn its written consent to the inclusion in the South32 Listing Document of this CPR.

1.6 Qualifications of Consultants, Competent Persons and Competent Evaluators

SRK is an associate company of the international group holding company SRK (Global) Limited. The SRK Group comprises over 1,500 staff, offering expertise in a wide range of resource engineering disciplines with 50 offices located on six continents. The SRK Group's independence is ensured by the fact that it holds no equity in any project. This permits the SRK Group to provide its clients with conflict-free and objective recommendations on crucial judgement issues. The SRK Group has a demonstrated track record in undertaking independent assessments of resources and reserves, project evaluations and audits, Mineral Experts' Reports, Competent Person's Reports, Mineral Resource and Ore Reserve Compliance Audits, Independent Valuation Reports and Independent Feasibility Evaluations to bankable standards on behalf of exploration and mining companies and financial institutions worldwide. The SRK Group has also worked with a large number of major international mining companies and their projects, providing mining industry consultancy service inputs.

SRK also has specific experience in commissions of this nature.

This CPR has been prepared based on a technical and economic review by a team of 11 consultants and associates sourced from the SRK offices in Australia over a 2-month period. These consultants are specialists in the fields of geology, resource and reserve estimation and classification, open-pit mining, geotechnical engineering, mineral processing, hydrogeology and hydrology, tailings management, infrastructure, environmental management and mineral asset technical valuation.

Rod Brown, Sjoerd Duim, Simon Walsh and Peter Smith visited the site for a total of two days during the week commencing 20 October 2014.

- Rodney Brown, BSc, MGAA, MAusIMM, MAIG – Geology and Mineral Resources
- Sjoerd Duim, MSc Eng (Mining Engineering), GDip (Engineering), MAusIMM – Mining and Ore Reserves
- Ian de Bruyn, BSc Hons (Engineering Geology), Pr.Sci.Nat., MAusIMM – Geotechnical engineering
- Ewan Wilson, PhD (Groundwater Management), MAusIMM – Hydrology
- David Western, MSc (Hydrogeology), MIAH, MAusIMM, MIMWA, MAWA – Hydrogeology
- Simon Walsh, BSc (Extractive Metallurgy & Chemistry), MBA, MAusIMM, GAICD – Metallurgical processing
- Dave Luppnow, BSc (Civil Engineering), PE (Washington) – Tailings
- Peter Smith, BSc (Environmental Sciences), Environmental; GDip Course (Advanced Environmental Management and Environmental Impact Assessment), MAusIMM – Environmental
- Luke Esprey, PhD (Modelling), Pr.Sci.Nat., MAusIMM – Closure Cost Estimate
- Anthony Stepcich, BEng, MSc, GDip (Finance & Investment), Dip (Technical Analysis), MAusIMM(CP) – Technical valuation
- Peter Fairfield, BEng (Mining), FAusIMM – CPR review.

The Competent Person who has reviewed the Mineral Resources as reported by BHP Billiton is Mr Rodney Brown, BSc, MGAA, MAusIMM, MAIG, who is an employee of SRK. He is a Member of The AusIMM within the meaning of the JORC Code. Rod Brown is a mining geologist with over 25 years' experience in the mining industry and has been involved in the reporting of Mineral Resources on various properties internationally during the past 20 years.

The Competent Person who has reviewed the Ore Reserves as reported by BHP Billiton is Mr Sjoerd Duim, qualifications, MSc Eng (Mining Engineering), GDip (Engineering), who is an employee of SRK. He is a Member of the The AusIMM. Sjoerd Duim is a mining engineer with over 32 years' experience in the mining industry and has been involved in the reporting of Ore Reserves on various properties internationally during the past 11 years.

The Competent Person and Competent Evaluator is Mr Anthony Stepcich, MSc (Mineral Economics), BEng (Mining), Grad Dip (Finance & Investment), Dip (Technical Analysis), MAusIMM(CP), who is an employee of SRK. Anthony Stepcich is a mining engineer with over 21 years' experience in the mining and metals industry and has been involved in the preparation of Competent Persons' Reports comprising technical valuations on various mineral assets internationally during the past nine years. Anthony Stepcich assumes the responsibility for the estimates presented and has the relevant experience to be considered an Expert under the VALMIN guidelines. Mr Stepcich did not visit site and has relied on site visit reports of the SRK specialists who visited the site and carried out the technical review.

2 Overview

2.1 Property description

BWAPL is an integrated bauxite mining/alumina refining operation that includes rail and port facilities. The mine is located some 123 km south east of Perth and the refinery is situated 55 km northeast of the port of Bunbury, Western Australia. The operation opened in 1983 and the Boddington Bauxite Mine supplies bauxite ore to the Worsley Alumina Refinery via a 51 km-long conveying system. Capacity has increased from the original 1 Mtpa of alumina production to the current nameplate capacity of 4.6 Mtpa through a series of expansions. BWAPL is the operator and ownership is held within a Joint Venture (BHP Billiton 86%, Sojitz Alumina 4% and Japan Alumina 10%). BHP Billiton's share of BWAPL FY2014 production was 3.9 Mt of alumina.

2.2 Property rights

The status of land tenure is as follows:

- Mining Lease (M70/258SA) was granted to the Worsley Joint Venture (WJV) Partners on 16 August 1983 (expires 15 August 2025). M70/258SA was granted through the Agreement Act and covers both State Forest and privately owned land. There are no annual reporting requirements under M70/258SA.
- WJV is the holder of mining leases M70/110, M70/111, M70/112, M70/113, M70/114, M70/115 and M70/116. There are no specific tenement conditions in these mining leases that relate to environmental management and reporting.
- WJV is also the holder of mining leases M70/21, M70/22, M70/23, M70/24, M70/25, M70/554, M70/564, M70/799 and M70/976. There are tenement conditions in these mining leases that pertain to environmental management and reporting, and mine closure plans. WJVs has sub-leases with the Boddington Gold Mine for use of the above mining leases (i.e. through the Restated Cross Operation Agreement [RCOA], dated 30 September 2002). The tenement conditions that pertain to environmental management and reporting, and mine closure plans, all relate to the Boddington Gold Mine.
- WJV also holds sub-leases of two parts excised from ML1SA held by Alcoa of Australia Limited. These sub-leases are covered under the Deed of Sublease between Alcoa of Australia Limited and BWAPL (dated 14 February 2001), and the Deed of Sublease between Alcoa of Australia Limited and BWAPL (dated 31 August 2001).
- WJVs holds Exploration Licence E70/710 (granted 16 January 1989, expiry 15 January 1997). SRK notes that E70/710 is recorded being "Live" (i.e. not expired) on the Department of Mines and Petroleum (DMP) database.
- WJV also holds several General Purpose Leases for the construction of the Campsite for the project expansion. All these General Purpose Leases are current and will expire on 31 August 2019. The tenement conditions contain only general environmental provisions, and there are no annual environmental reporting requirements.
- WJV also has Crown Leases granted under the Agreement Act for the Overland Conveyor (CL19/1986, LR3149/678, LR3149/679, LR3149/680, LR3149/681, LR3149/682, LR3149/683, LR3149/684, LR3149/685, LR3150/736 and LR3150/738), and for the Refinery (LR3080/471, LR3080/472, LR3080/473, and LR3080/474).
- The Port is situated on lease (LR3115/503) leased through the Bunbury Port Authority.

2.3 Environmental Permits and Approvals

BWAPL has current key environmental approvals and permits in line with the relevant Australian Federal and WA State environmental legislative requirements.

The status of the project's environmental approvals and permits is outlined below:

Federal Environmental Approvals

- *Native Title Act 1993* (Native Title Act): There is no Native Title Agreement for the project. However, there is a Native Title Claim covering the general project area and surrounds – the Gnaala Karla Booja Native Title Claim. This Native Title Claim is included in the WA South West Native Title Settlement being negotiated by the WA Government. BWAPL has stated that there are no current or anticipated impacts / risks to the project from this Native Title Claim, and that the mining leases that are located on private property are not subject to any Native Claim.
- *Environment Protection and Biodiversity Conservation Act 1999* (EPBC Act): Approval for the Worsley Alumina Project Expansion under the EPBC Act (EPBC 2004/1566) was issued by Minister for the Environment and Heritage on 6 June 2007.

WA State Agreement Act

- *Alumina Refinery (Worsley) Agreement Act 1973* (Agreement Act): This Agreement Act was established in 1973 and is the main State project approval and regulatory instrument. It covers the Mine, Overland Conveyor, Refinery and Port Facilities. The key environmental provisions within the Agreement Act are the obligations for the implementation of EP Act Part IV approval commitments and annual environmental reporting.
- Extension of the Overland Conveyor (i.e. Plan Z Amendment): On 27 October 2009, the WA Minister for State Development granted approval under the Agreement Act for the extension of the Overland Conveyor.

WA State Environmental Approvals and Permits

- *Environmental Protection Act 1986* (EP Act) Part IV – The Worsley Alumina Project Expansion was approved under Part IV of the EP Act through Ministerial Statement 719 (MS719) which was issued by the WA Minister of Environment on 13 April 2006. MS719 includes seven attachments for project non-substantial changes undertaken from 2007 to 2012. MS719 provides approval to mine within the designated PBA and provides for future mining outside of the PBA. Ministerial Statement 751 as a result of a 546 application against MS179 has also been granted.
- EP Act Part V; the following have been issued under Part V of the EP Act:
 - Works Approvals (2) – for construction and commissioning of the power generation facility and infrastructure for increased production capacity, and the multi-fuel cogeneration boiler (both expire on 14 August 2015).
 - Environmental Licences (2) – the Mine licence (L5960/1983/11 – expires 30 September 2019) and Refinery licence (L4504/1981/16 - expires 30 September 2015).
 - Environmental Registration (No. 1859) – for the port facility (no expiry).
 - Native Vegetation Clearing Permits (2) – Area Permit 4481/1 for the clearing of 5.04 hectares (ha) of native vegetation within M70/258SA (expires 1 October 2016), and Purpose Permit 4331/1 for the clearing of 2.71 ha native vegetation for purpose of infrastructure maintenance on the Overland Conveyor (expires 25 July 2016).
- *Rights in Water and Irrigation Act 1914* (RIWI Act):
 - BWAPL holds a current licence to take water (surface water) No. SWL68041(4), which was issued on 26 April 2013 (expires 8 October 2018). This licence authorises BWAPL to take 5,400,000 kilolitres (kL) per year from the freshwater lake at the refinery.

- Groundwater is extracted at the mine through several groundwater bores which are not required to be licenced under the RIWI Act, as the mine is not located within a proclaimed groundwater resource area.
- *Aboriginal Heritage Act 1972 (AH Act)* – To date, there has been no requirement for the approval under the AH Act to disturb an Aboriginal heritage site. BWAPL has, through the completion of Aboriginal heritage sites surveys for the project area, identified all Aboriginal heritage sites of significance and these have been protected from disturbance.
- *Mining Rehabilitation Fund Act 2012 (MRF Act)*:
 - BWAPL is not required to make MRF Act submissions and payments for the project mining lease M70/258SA (i.e. as mining leases issued under State Agreement are exempt from making levy payments under the MRF Act).
 - BWAPL is required to make MRF Act submissions and payments for the mining leases it holds and the leases that are subleased by the Boddington Gold Mine. BWAPL has submitted to DMP the 2014 summary of areas of disturbance as required under the MRF Act and paid the required fee (A\$17,686). Newmont Asia Pacific has made the 2014 MRF Act levy payments to the DMP on behalf of BWAPL for the subleased areas. SRK has sighted an email from Newmont Asia Pacific to BWAPL that confirms three MRF Act levy payments were made to the DMP on 17 July 2014 (i.e. for the amounts of A\$24,089, A\$1,172,142 and A\$111,579).
 - SRK has also sighted an email from the DMP dated 27 September 2014 confirming that Unconditional Performance Bonds for the mining leases that are sub-leased by the Boddington Gold Mine have been retired. Unconditional performance bonds for Worsley-operated tenements M70/116 and M70/114 have also been retired.
- *Dangerous Goods Safety Act 2004 (DGS Act)* – There are two current dangerous goods licences for the Refinery. (Licence No.DGS009760) was issued on 19 April 2012 (expires 19 April 2017) and covers the storage of fuel and chemical reagents; and Licence DGS012436, was issued 18 June 2012 (expiry 23 June 2016) and covers the storage of sodium hydroxide solution. The current dangerous goods licence for the Mine (Licence DGS009772) was issued on 23 April 2012 (expiry 27 April 2016), and covers the storage of diesel fuel. The current explosive storage licence for the mine (Licence No.ETS002343) was issued on the 17 June 2012 (expires 18 June 2019).
- *Mining Act 1978 (Mining Act)* - The BWAPL does not require environmental approval under the Mining Act. However, BWAPL has utilised relevant technical guidelines produced by the DMP in relation to factors such as closure planning and rehabilitation.
- *Contaminated Sites Act 2003 (CS Act)* – The BWAPL is required under the CS Act to report known and/or suspected contaminated sites to the Department of Environment Regulation (DER). To meet this obligation, BWAPL has developed a Contaminated Sites Reporting Strategy and has submitted a Preliminary Site Investigation report to the DER (Section 13.6).

3 Geology and Resource

The June 2014 Competent Person's Report for BWAPL (BWAPL, 2014), was used as the primary source of information for this review. This was supplemented by site visit observations, discussions with BWAPL personnel, the main resource modelling files, and ancillary study reports. The review focused on the main components that can impact upon the reliability of the resource estimates, namely the geological model, the data acquisition program, and the resource estimation techniques and parameters.

Rod Brown visited the Worsley Refinery site on 22 and 23 October 2014. The site visit included discussions with site personnel, inspection of the mining operation, and inspection of the Marradong and Saddleback crushing facilities.

3.1 Mineral Resource

The Mineral Resource provided by BWAPL declares the combined resources for 10 separate regions within their Darling Range lease area. The total Mineral Resource is summarised in Table 3-1. A location plan showing the individual resource regions is presented in Figure 3-1.

The cut-off grade parameters that have been used for the preparation and the reporting of the resource estimates are based on achieving the available alumina (A.Al₂O₃) and reactive silica (R.SiO₂) grade specifications requested by the refinery. The parameters used for bauxites, that have developed on granites, differ from those used for bauxites, that have developed on greenstone.

Greenstone (Marradong, Saddleback, Hotham North):

- Gravel: > 29.5% A.Al₂O₃ and < 3.0% R.SiO₂
- Other Domains: > 24.0% A.Al₂O₃ and < 3.0% R.SiO₂.

Granite (Brookton, Collie, Collie East, Collie South, Hotham West, Mid-Central, Southern):

- Gravel: > 29.5% A.Al₂O₃ and < 4.5% R.SiO₂
- Other Domains: > 28.0% A.Al₂O₃ and < 4.5% R.SiO₂.

The above grades are based on WDIE analyses, except for greenstone R.SiO₂, which are based on Worsley Laboratory Available Alumina (WLAA). These analytical techniques were developed by BWAPL and are described in Section 3.4.3.

Table 3-1: Mineral Resource as at 30 June 2014 (inclusive of Reserves)

Ore type	Measured Resource			Indicated Resource			Inferred Resource			Total Resource			BHPB interest
	Mdt	A.Al ₂ O ₃ ⁽¹⁾	RxSiO ₂ ⁽²⁾	Mdt	A.Al ₂ O ₃ ⁽¹⁾	RxSiO ₂ ⁽²⁾	Mdt	A.Al ₂ O ₃ ⁽¹⁾	RxSiO ₂ ⁽²⁾	Mdt	A.Al ₂ O ₃ ⁽¹⁾	RxSiO ₂ ⁽²⁾	
Laterite	366	31.1	1.5	355	32	2.3	418	31.2	2.6	1,140	31.4	2.2	86%

(1) A.Al₂O₃ – available alumina reported at Worsley Design Indicated Extraction basis (WDIE)

(2) RxSiO₂ – reactive silica reported at Worsley Design Indicated Extraction basis (WDIE)

The Mineral Resource is reported at a variable cut-off grade of 24-29.5% A.Al₂O₃ (WDIE basis) and a minimal 1 m laterite profile thickness.

The FY2014 reported Mineral Resource is significantly different from the FY2013 statement mainly due to:

- Mining depletion from Marradong and Saddleback areas: -14 million dry metric tonnes (Mdt)
- Model update of Hotham North: +17 Mdt
- Changes to Resource model methodology of Brookton, Collie East, Collie (Worsley), Collie South, Hotham West, Mid-Central, Southern ML258SA: +166 Mdt
- Sterilisation and re-evaluation of exercise rules: -2 Mdt.

Source: BWAPL (2014)

3.2 Mineral Resource (SRK Depleted)

Based on the Mineral Resource (Worsley), SRK has prepared a Mineral Resource (SRK Depleted) as at 31 December 2014, as detailed in Table 3-2.

Table 3-2: Mineral Resources as at 31 December 2014 (inclusive of Reserves)

Ore type	Measured Resource			Indicated Resource			Inferred Resource			Total Resource			BHPB interest
	Mdt	A.Al ₂ O ₃ ⁽¹⁾	RxSiO ₂ ⁽²⁾	Mdt	A.Al ₂ O ₃ ⁽¹⁾	RxSiO ₂ ⁽²⁾	Mdt	A.Al ₂ O ₃ ⁽¹⁾	RxSiO ₂ ⁽²⁾	Mdt	A.Al ₂ O ₃ ⁽¹⁾	RxSiO ₂ ⁽²⁾	
Laterite	358	31.1	1.5	355	32	2.3	418	31.2	2.6	1,131	31.4	2.2	86%

The Mineral Resource Inventory forecast as of 31 December 2014 is based on the following depletions from the 30 June 2014 Resource Inventory:

- Actual Measured Resource depletion from July to October 2014: 4.8 Mt @ 32.3% A.Al₂O₃; and 1.2% RxSiO₂
- Forecast Measured Resource depletion from November to December 2014: 2.9 Mt @ 30.3% A.Al₂O₃ and 1.5% RxSiO₂.

Note:

This report includes information on Mineral Resources (inclusive of Ore Reserves) as reported by J Binoir (MAusIMM) and J Engelbrecht (MAusIMM). The information is extracted from the report titled BHP Billiton 2014 Annual Report and is available to view on www.bhpbilliton.com.

All Competent Persons are full-time employees of BHP Billiton at the time of reporting and have the required qualifications and experience to qualify as Competent Persons for Mineral Resources under the 2012 Edition of the "Australasian Code for Reporting of Exploration Results, Mineral Resources and Ore Reserves" (JORC Code). The Competent Persons verify that the report is based on and fairly reflects the Mineral Resources information in the supporting documentation and agree with the form and context of the information presented.

BHP Billiton confirms that it is not aware of any new information or data that materially affects the information included in the original market announcements and, in the case of estimates of Mineral Resources that all material assumptions and technical parameters underpinning the estimates in the relevant market announcements continue to apply and have not materially changed. BHP Billiton confirms that the form and context in which the Competent Persons' findings are presented have not been materially modified from the original market announcements.

The Mineral Resources breakdown by classification (100% basis) are contained in Table 3-1. All tonnes and quality information has been rounded, hence small differences may be present in the totals.

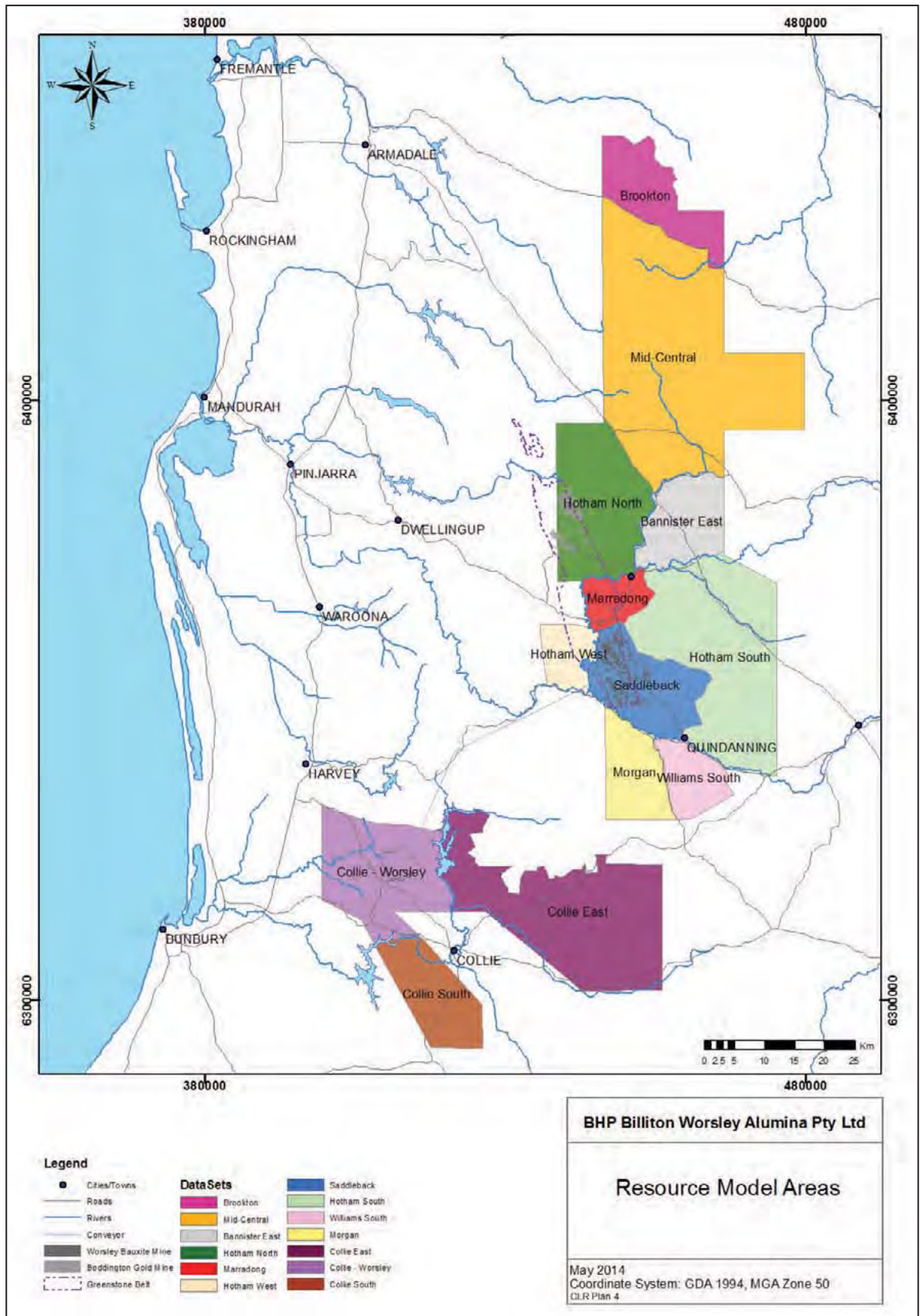

Figure 3-1: BWAPL Resource regions

Source: BWAPL (2014)

3.3 Geological Setting

3.3.1 Regional Geology

The BWAPL deposits are located on the eastern flanks of the Darling Ranges approximately 100 km south-southeast of Perth in the south west of Western Australia. The bauxites have developed on the exposed Achaean basement of the Western Gneiss Terrane, which is located on the western edge of the Yilgarn Block. In the project area, the Western Gneiss Terrane is predominantly composed of granitic gneisses and migmatites, as well as the greenstones of the Saddleback Greenstone Belt. The northerly trending greenstone belt is approximately 43 km long and 5 – 12 km wide, and consists of sequences of mafic to felsic volcanics, pyroclastics, and sediments that have undergone greenschist facies metamorphism. The gneisses and greenstones have been intruded by relatively undeformed granites, and subsequently by numerous northerly trending doleritic dykes that range in thickness from 1 to 200 m. The dominant structural feature in the region is the Darling Fault, which forms the western boundary of the Western Gneiss Terrane.

The bauxites are thought to have formed from the lateritisation of the peneplained surface of the Western Gneiss Terrane rocks. Lateritisation is thought to have commenced during the Cretaceous and continued through to the Eocene. Subsequent periodic activity of the Darling Fault resulted in the current landform of scarps and deeply incised valleys on the western edge of the Darling Range. To the east, where the BWAPL deposits are located, the topography is more subdued, consisting of wide valleys and low hills separated by numerous minor streams. Remnant laterite occurs on the tops and flanks of these hills.

In the project area, bauxite exists as irregular lenses, locally referred to as **Pods**, within the remnant laterite. The pods are generally elongated in the NNW-SSE direction and vary in size from 1 to 200 ha. The majority of the pods contain approximately 2 million tonnes (Mt) of bauxite. The pods are generally confined to slopes where the gradient is between 5° and 10°. In steeper areas, the lateritic cover has often been removed by erosion. In areas where the slope gradients are less than 5°, sub-surface water flow is usually insufficient to promote the removal of the soluble silicate materials. The material in these areas often has a high clay content and is usually not economically viable.

A summary description of the bauxite occurrences in the 10 project regions is shown in Table 3-3.

Table 3-3: Summary of bauxite deposits

Brookton	Discontinuous mineralisation over an area covering 20 km northwest / southeast and 12 km northeast / southwest. The total profile depth from surface, varies from 1 m to a maximum of 14 m, but is generally only a few metres thick.
Collie East	Discontinuous mineralisation over an area covering 20 km north / south and 30 km east / west. Total thickness ranges from <1 m up to 16 m with an average thickness of 2.3 m.
Collie (Worsley)	Discontinuous mineralisation over an area covering 15 km north / south and 17 km east / west. Total thickness ranges from <1 m up to 10 m with an average thickness of 1.9 m.
Collie South	Discontinuous mineralisation over an area covering 17 km north / south and 15 km east / west. Total thickness ranges from <1m up to 12 m with an average thickness of 2.2 m.
Hotham North	Discontinuous mineralisation over an area covering 20 km north / south and 14 km east / west. Total thickness ranges from <1 m up to 27 m with an average thickness of 5.4 m.
Hotham West	Discontinuous mineralisation over an area covering 6 km north / south and 3 km east / west. Total thickness is up to 25 m but generally is roughly 5-6 m.

Marradong	Discontinuous mineralisation over an area covering 8 km north / south and 8 km east / west. Total thickness ranges from <1 m up to 30 m with an average thickness of 7.4 m.
Mid-Central	Discontinuous mineralisation over an area covering 45 km north / south and 30 km east / west. Total thickness ranges from <1 m up to 13 m with an average thickness of 3 m.
Saddleback	Discontinuous mineralisation over an area covering 19 km northwest / southeast and 10 km northeast / southwest. Total thickness ranges from <1 m up to 32 m with an average thickness of 7.3 m.
Southern MLA258SA	Hotham South covers and area is approximately 14 km north / south and between 5 km and 10 km east /west although mineralisation is discontinuous over this area. Williams South strikes roughly northwest over a distance of approximately 7 km. In the northeast direction, mineralisation stretched up to 2 km. Morgan covers to w areas with dimensions 6 km north / south and 4 km east / west as well as 6 km northwest / southeast and 2 km northeast / southwest. Mineralisation occurs from surface to depths <1 m and up to 11 m but general is only a few metres thick.

3.3.2 Bauxite characteristics

In the project area, bauxites have developed on the meta-basalts that comprise the Saddleback Greenstone Belt as well as on the surrounding granites. The bauxites that have formed on greenstone are usually thicker, higher in iron and sulphate, but lower in silica and organic carbon compared to the bauxites that have formed on granite. However, in general, the bauxite profile is similar across the project area, and typically comprises the horizons described below. Dolerite is not part of the lateritic profile, but it cuts the sequence and is included in the list below for completeness. A schematic depiction of the layers is presented in Figure 3-2.

- **Topsoil.** A mix of humus, sandy loam and gravel, which is typically 0.1 m thick.
- **Lateritic Gravel.** Unconsolidated iron rich pisoliths and gravels in a sandy or silty matrix generally between 0 and 2 m thick.
- **Hardcap.** A ferruginous and bauxitic indurated laterite consisting of cemented angular fragments and / or pisoliths. The dominant minerals are gibbsite, hematite and goethite, with lesser amounts of quartz, maghemite and kaolinite also present. The hardcap is typically 3 m thick over greenstone and 1 m thick over granite.
- **Bauxite Zone.** (B zone). A friable, unconsolidated, yellow-brown to red-brown bauxitic layer in which the original rock textures have been destroyed. The dominant minerals are gibbsite, goethite and hematite, with minor kaolinite and trace illite. The horizon is often referred to as the *B-zone*, and is generally between 1 and 8 m thick.
- **Clay Zone.** Kaolinite clays with variable degrees of ferruginisation, silicification and kaolinisation. Relict bedrock textures and quartz veins are common. The dominant minerals are kaolinite, mica or illite, kaolinite-halloysite, quartz and phyllosilicates. The Clay Zone is generally 10 – 30 m thick.
- **Lower Saprolite.** A transitional zone between fresh bedrock and the overlying clay zone. This zone is typified by partially weathered bedrock fragments in a clay matrix. It is often referred to as “basement” in the geological logs.
- **Dolerite.** The dykes range in breadth from several to over 100 m wide. These are not bauxitised, and in places have acted as impediments to drainage. As a consequence, proximal bauxite on the upslope side of dykes often reports elevated reactive silica concentrations.

With the exception of the top of the Hardcap, most contacts are transitional, although the thickness of the transition zone can vary markedly. The dominant minerals are gibbsite, kaolinite, quartz, hematite and goethite. Elevated concentrations of organic carbon occur in the upper parts of the profile. These are monitored in the feed (expressed as oxalate) because of the adverse effect on

refining. In general, boehmite occurs in trace concentrations only. It is thought to have formed from the dehydration of gibbsite during periodic wildfire activity and is typically confined to the upper parts of the profile. Some available alumina is also thought to occur as aluminogothite, and some partially reactive silica is thought to exist in an amorphous form.

The deposits are described as lateritic bauxites. Compared to many mined lateritic bauxites, they report relatively low total and available alumina, low reactive silica, high quartz grades and, apart from organic carbon, few contaminant minerals.

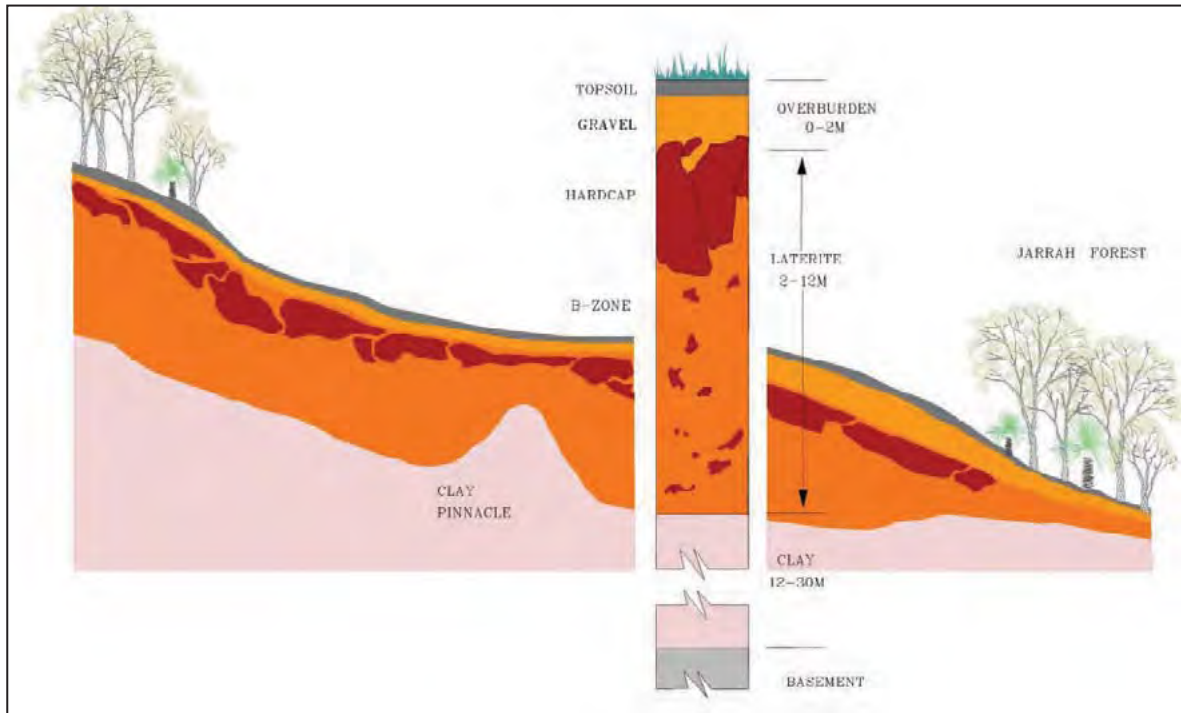

Figure 3-2: Typical profile of Darling Range bauxite

Source: BWAPL (2014)

3.4 Data acquisition

BWAPL has used similar data acquisition techniques for the delineation of resources in all of the regions included in the resource inventory and, unless otherwise stated, the commentary below applies to all of the individual resource estimates.

3.4.1 Exploration history

The economic viability of Darling Range bauxite was recognised in the late 1950s, and numerous exploration programs have been conducted by several companies since then. The majority of the early programs were conducted by Alwest Pty Ltd. In 1978, management transferred to Reynolds with the formation of the Worsley Alumina joint venture and the commencement of mine and refinery design. Production of alumina commenced in 1984.

The current databases that have been used to prepare the resource estimates still contain some legacy data from the early Alwest and Reynolds (later Alcoa) programs, but the majority of the data have been collected by BWAPL since 1993. Table 3-4 presents a summary of the numbers of drillholes used for resource estimation, grouped according to period.

Table 3-4: Drillhole quantities used for Resource Estimation

Region	pre 1993	1993 – 2006	2007 - 2014
Saddleback	35035	50341	9003
Marradong	2220	3123	20799
Hotham North	7844	4283	3057
Collie	392	5456	21426
Hotham South	24	1119	408
Hotham West	81	148	812
MCE Bannister	240	7043	7467
MCE Brookton	89	912	2815

3.4.2 Sample spacing and collection

Prospective areas are determined from regional reconnaissance drilling, or by identifying areas with suitable topographical and floral characteristics. The regional mapping of hardcap exposures is not routinely practiced. Prospective areas are drilled on a 200 x 200 m grid pattern. The wide-spaced drilling is conducted prior to any clearing and development operations, and to date has been limited to the summer months. Subsequent infill drilling is then conducted in prospective areas using 100, 70, 50 and 25 metre square and quincunx patterns.

Open-hole drilling is conducted using a fleet of Edson 2000 tractor-mounted vacuum drill rigs. The drills are equipped with 50 mm diameter bladed bits and the sample is extracted using vacuum to draw the sample from the cutting bit through the hollow drill rods into a collection flask. Sampling commenced at the base of the overburden soils and was terminated when either clay or basement material was encountered. Wet holes were abandoned and redrilled at a later date. Samples were collected on nominal intervals of either 0.5 m or 1.0 m, and typically weighed between 2 and 4 kg. There has been little change to the drilling techniques in the past 40 years. Similar equipment is used on other Darling Range mines, and in the local industry it is widely considered as being fit for purpose.

A cone splitter was used to collect a split weighing approximately 500 g. Prior to 2004, riffle splitters were used for this purpose. The drillers complete a basic geological log for each hole. The information from these logs was used to determine the position of the Hardcap and B Zone base. Since the start of 2014, the driller has recorded an estimate of the sample recovery for each interval. BWAPL reports recoveries ranging from 50 - 200%, with an average of approximately 175%. This significant amount of oversampling is likely due to “belling” of the hole walls when drilling through friable zones. The expected impact on sample quality is discussed in Section 3.11

3.4.3 Sample preparation and analysis

Detailed descriptions of the sample preparation and analytical procedures that were used prior to 1993 are not available, but BWAPL reports that they are understood to be similar to their current practices, which are summarised in the flowchart presented in Figure 3-3.

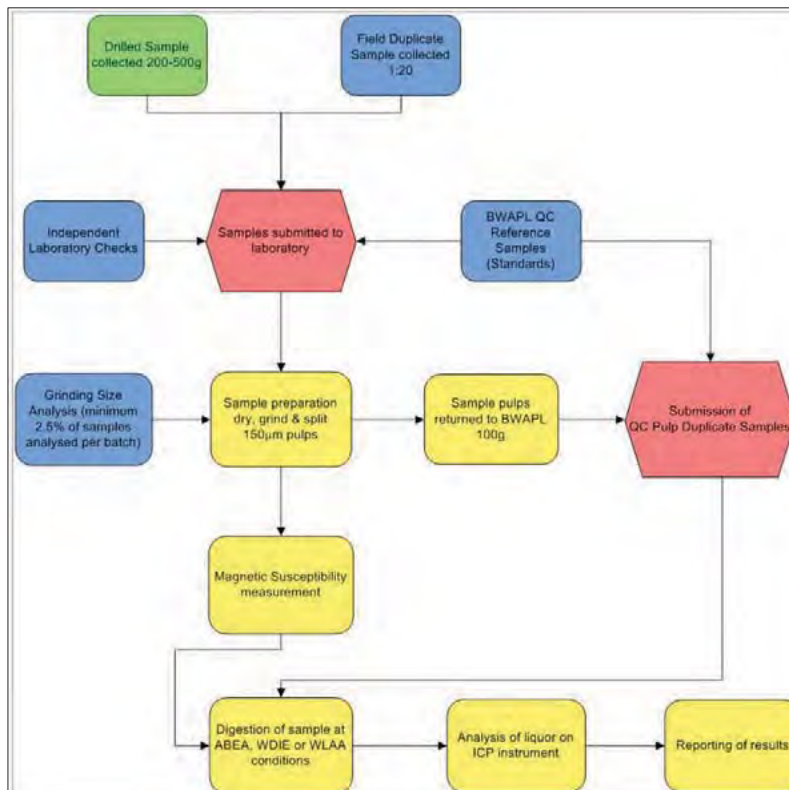

Figure 3-3: Sample preparation and analysis flowchart

Source: BWAPL (2014)

For bauxite projects, bomb digest tests are often performed to provide an estimate of the amount of alumina that will be recovered in the Bayer refining process and the amount of silica that will react with and consume caustic soda. These quantities are referred to as available alumina ($A.Al_2O_3$) and reactive silica ($R.SiO_2$) respectively. For low temperature digestion, $A.Al_2O_3$ is largely determined by the gibbsite content and $R.SiO_2$ by the kaolin content.

Bomb digest tests are partial extraction techniques, with the results strongly dependent on the test parameters, particularly temperature and caustic concentration. The resource database contains results acquired using three different protocols, which have been performed by a number of commercial laboratories since the commencement of the project. Genalysis (Perth) is currently used as the primary laboratory.

Prior to 2001, bomb digests were performed using the American Bayer Extractable Alumina (ABEA) method. In 2001, the procedure was changed to the Worsley Design Indicated Extraction (WDIE) method in an attempt to better match the refinery operating conditions. WDIE uses a larger sample (2 g compared to 1 g), a higher temperature (175°C compared to 145°C), a stronger caustic concentration (12.6% wet weight compared to 8.0%), and a longer digestion time (30 minutes compared to 20 minutes).

As reconciliation data became available for the resources estimated using WDIE data, it was observed that the WDIE tests were possibly too aggressive and were over-reporting the $A.Al_2O_3$ and $R.SiO_2$ grades when compared to refinery performance. In 2012, a revised procedure referred to as the Worsley Laboratory Available Alumina (WLAA) method was implemented. WLAA tests a 1 g sample using the similar test conditions as for WDIE; however, a small alumina charge is added to the caustic solution to account for the fact that the recirculated refinery liquor contains a residual alumina loading.

Inductively coupled plasma (ICP) was used to determine the alumina and silica concentrations of the digest solutions. Major oxide concentrations were determined by fused bead X-ray fluorescence (XRF), organic carbon by Leco, and extractable oxalates and sulphates by ion chromatography (IC) or Fourier transform infrared (FTIR) spectroscopy. Magnetic susceptibility tests were performed on the sample pulps.

BWAPL has examined the relationships between ABEA and WDIE results and has used a linear regression to convert the historical ABEA results to WDIE results. Since 2012, BWAPL has commenced the systematic re-assaying of pulps using WLAA. Comparisons between WDIE and WLAA indicate that WDIE reports higher concentrations of $A.Al_2O_3$ and $R.SiO_2$ compared to WLAA (2% and 0.1% absolute respectively). An independent review made recommendations that the risk of over-reporting the $A.Al_2O_3$ resource grades be mitigated by applying an adjustment to the existing WDIE grades (Coombes 2014). BWAPL is currently reviewing the recommended adjustment algorithms to confirm that they are applicable for all of the laterite horizons.

3.4.4 Density data

BWAPL does not routinely conduct bulk density determinations on bauxite samples. A nominal dry *in situ* bulk density value of 2.04 tonnes per cubic metre (t/m^3) was used for estimation of Resource and Reserves. This value has been derived from a long-term comparison between refinery production and the actual volumes mined, as well as the results from a limited number of tests conducted on PQ core samples collected in 2006. The nominal density has undergone periodic revision; it was revised to 1.9 t/m^3 in 1989 from a previous 2.0 t/m^3 in 1989. BWAPL is planning to embark upon a program in 2015 to collect density data from individual bauxite horizons. The program is expected to include core drilling, active mining face sampling, and *in situ* sand replacement testing.

3.4.5 Survey

All survey data are reported using Map Grid of Australia (GDA94), with elevations referenced to Australian Height Datum (AHD) - 1971. A variety of techniques has been used for drill collar surveying, including differential global positioning system (DGPS), global positioning system (GPS), electronic distance measuring (EDM), and theodolite. The holes were usually drilled within 5 m of the collar peg for 200 m-spaced holes and within 1 m for smaller spacings. The offset was measured if these tolerances were exceeded. The collars were not resurveyed after drilling. If no offset was recorded, the planned collar coordinates were entered into the drillhole database.

All holes are assumed to be vertical, but the rig is not levelled and minor departures from vertical may exist on steep gradients. The holes were not downhole surveyed. Any apparent thickness errors that result from the assumption that the holes are vertical when in fact many may deviate from this by several degrees are expected to be minimal given that the majority of the holes are only several metres deep.

The topographic surface was generated from 5 m contour data provided by the Department of Land Administration (DOLA) in 1995. BWAPL does not have descriptions of the source data or the derivation of the contour data. Prior to resource estimation, BWAPL apply adjustments to the drillhole collars such that they are consistent with the topography.

3.4.6 Quality Assurance data

BWAPL reports that quality assurance/ quality control (QA/QC) data are not available for the exploration data collected prior to 1993. This represents approximately 25% of the database. The following QA/QC procedures have been introduced since 1993:

- Laboratory internal QA/QC data collected from 1993 onwards – includes: duplicates, repeats, standards, and blanks. Standards appear to have been prepared from primary sample rejects
- Routine collection of field duplicates commenced in 2005 – these were submitted at a frequency of 1:20
- Relabelling and resubmission of returned pulps commenced in 2005 – these samples were initially submitted at a frequency of 1:100. From 2012 onwards, frequency was increased to 1:20.

BWAPL reports that the quality assurance data are regularly monitored, with any identified issues referred back to the laboratories. BWAPL used absolute mean percent relative difference (AMPRD) as the primary tool to monitor precision, with trigger levels of 90% < 10% AMPRD for A.Al₂O₃ and 80% < 20% AMPRD for R.SiO₂.

The results presented in the BWAPL QA/QC reports indicate that, in general, results just below or around the precision targets were achieved for most programs (the target threshold is relatively onerous for field duplicates). Differences between the various laboratories are evident, but there appears to have been a slight improvement in performance for the later programs. The results presented in the reports do not show evidence of significant bias. The results highlight the relatively high level of uncertainty associated with bomb digest analysis, particularly for R.SiO₂.

3.5 Resource estimation

Separate resource modelling studies have been completed for the 10 resource regions for which resource estimates are reported in Table 3-2. Estimates and reports for the greenstone-derived bauxites (Saddleback, Marradong, and Hotham North) were completed and issued by Golder Associates Pty Ltd (**Golder**) in 2012. Estimates and reports for the granite-derived bauxites were completed and issued by BWAPL in 2014. From here on, these are described as the *Greenstone* models and *Granite* model respectively.

A similar general approach was used for all deposits, although there were some differences in the specific ways in how the approach was implemented, particularly when comparing the Greenstone and Granite studies. Unless otherwise stated, the commentary below applies to all of the individual resource estimates.

3.5.1 Geology Model

The geology models were prepared using both the geological logging data recorded by the drillers, the magnetic susceptibility data, and the geochemical data. The lateritic horizons were defined in each drillhole using the following criteria:

- **Gravel (GC)** – If present, as identified in the drill logs.
- **Hardcap (HC)** – If present, the top is as identified in the drill logs. The base is defined by a step change in magnetic susceptibility.
- **Bauxite Zone (BZ)** – The top coincides with the base of HC, and the zone includes samples where A.Al₂O₃ > 10% and R.SiO₂ < 4. Up to two consecutive samples with grades that do not meet these criteria can be included in BZ if an underlying sample meets the criteria.
- **Bauxitic Clay (BC)** – Where A.Al₂O₃ > 10% and R.SiO₂ > 4 < 8%, and it has not been logged as GC, HC or BA.
- **Clay (CL)** – Where A.Al₂O₃ < 24% and R.SiO₂ > 8%, and it has not been logged as GR, HC or BA.
- **Basement (BA)** – As identified in the logs.

After assigning a lithology code to each sample, each drillhole was checked to ensure the strict stratigraphic ordering shown above was retained. Missing units were added to the sequence and assigned a *zero* thickness. The 3D coordinates of the base of each horizon in each drillhole were calculated and triangulated to produce a wireframe surface. Each surface was then folded to mimic the topographic surface. A pictorial representation of the folding approach is shown in Figure 3-4. The volumes bounded by these surfaces are referred to as the lithology domains. For the Granite models, the lithology domains were used as the estimation domains.

For the Greenstone models, a similar approach was used for the definition of lithological domains. However, within each horizon, an automated approach using deposit specific criteria was applied to identify “ore” and “waste” sub-zones. This meant that each lithological unit (except basement) could notionally consist of three sub-zones; overburden waste, bauxite, and underburden waste. For the Greenstone models, the sub-zone domains were used as the estimation domains.

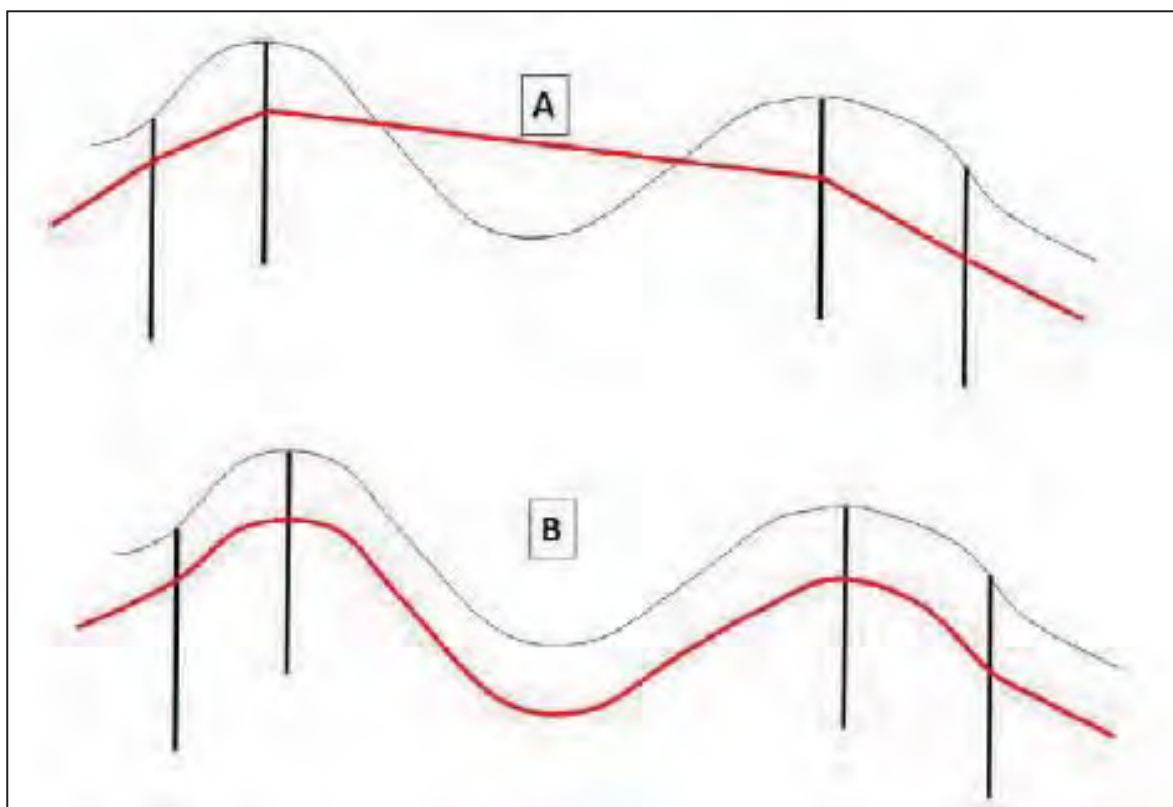

Figure 3-4: Stratigraphic surfaces folded to topography

Sourced from Golder (2012a)

3.5.2 Volume Model

Conventional block models oriented parallel to the GDA94 grid were prepared to represent the deposit volumes. Kriging neighbourhood analysis (KNA) studies were used to assist with the selection of the cell size for the Granite models. For the Greenstone models, the drill spacing and the expected mine planning requirements were taken into account when selecting the cell size. The following sizes were used:

- Greenstone Models - Parent Cell: 25 x 25 x 3 m. Sub-cell: 5 x 5 x 1 m (XYZ)
- Granite Models - Parent Cell: 50 x 50 x 1 m. Sub-cell: 12.5 x 12.5 x 0.5 m (XYZ).

The domain wireframes were used to assign domain codes to each model cell. Cells located above the topographic surface were removed from the volume model.

3.5.3 Estimation datasets

The estimation domain wireframes were used to assign domain codes to each drillhole sample. For the Granite models, the samples within each domain were composited to a nominal length of 0.5 m. The composite length was allowed to vary between 0.2 m and 0.75 m to minimise the number of residual samples. Density weighting was not used during compositing.

For the Greenstone models, the samples within each estimation domain were composited to a maximum length of 1.0 m. Residual composites with lengths of less than 0.05 m were excluded from the datasets (this represented approximately 16% of the samples). Density weighting was not used during compositing.

Grade cuts were not applied to any of the estimation datasets. For the Greenstone models, the influence of high R.SiO₂ composites was reduced by applying tighter search constraints (Section 3.5.5).

The estimation datasets contained grade data for A.Al₂O₃, R.SiO₂, SiO₂, K₂O, Na₂C₂O₄, and TOC.

3.5.4 Exploratory data analysis

Statistical analyses were conducted on the abovementioned constituent grades in each domain. This included the preparation of summary statistics tables, histograms, and cumulative frequency plots. Contact analysis and drift analysis studies were also performed to assess the suitability of the domaining and to assist with the selection of boundary constraints during estimation.

Variographic studies were conducted to assist with the selection of estimation parameters. For each constituent in each domain, downhole variograms were generated to assist with the selection of nugget values. Experimental horizontal variogram fans were prepared to assist with the identification of the directions of anisotropy. The major, intermediate, and minor directions of continuity were modelled and used to define a 3D continuity model. Omnidirectional variograms were used if well-structured directional variograms could not be obtained.

The variogram models show relatively large differences for different constituents within a given domain, as well as for the same constituent in different domains and different regions. In general, the models could be typified as exhibiting relative low nugget values (~5%), useful ranges of a few hundred metres (~80% of the sill), with total ranges exceeding 1,000 m.

3.5.5 Grade estimation

A similar general approach of using distance weighting techniques to estimate the grades of each model cell has been used for all models. Table 3-5 presents a summary of the estimation parameters used for the Greenstone and Granite models. The same parameters were used for all of the Greenstone models, whereas they were individually tailored for each of the Granite models. The search parameters for Hotham South are presented for illustrative purposes.

Table 3-5: Summary of estimation parameters

Parameter	Greenstone Models	Granite Models (Hotham South)
Technique	Ordinary Kriging	Ordinary Kriging IDW where interpretable variograms could not be obtained
Parent Cell Estimation	Yes	Yes
Discretisation (xyz)	2 x 2 x 2	8 x 8 x 2
Length Weighting	Yes	No
Octant Searching	Yes	Yes
Keyfield restriction	3 samples per hole	3 samples per hole
Search Strategy	4 Pass.	1 Pass for Hotham West and South. 2 Pass for others Different search for Lithology and Constituent combinations
Samples, Search distances	Pass1. 8 - 40 samples, 40 x 40 x 2 m Pass2. 4 - 40 samples, 80 x 80 x 5 m Pass3. 2 - 40 samples 160 x 160 x 10 m Pass4. 1 - 40 samples 480, 480, 30 m	Gravel. A.Al ₂ O ₃ : 1500 x 1100 x 100 m. R.SiO ₂ : 2000 x 1500 x 100 m Hardcap. A.Al ₂ O ₃ : 500 x 500 x 100 m. R.SiO ₂ : 600 x 600 x 100 m B Zone. A.Al ₂ O ₃ : 800 x 800 x 100 m. R.SiO ₂ : 300 x 300 x 100 m Bauxitic Clay. A.Al ₂ O ₃ : 400 x 400 x 100 m. R.SiO ₂ : 1500 x 900 x 100 m 8 – 24 samples
Unestimated grades	Composite domain average	Not stated
Unfolding (estimation)	To topography	No
Boundary Control	Hard	A.Al ₂ O ₃ : Hard except for HC/BZ, BC/CL R.SiO ₂ : Hard except for BZ/BC, BC/CL
Additional Constraints	High R.SiO ₂ nearest parent cell.	None

3.6 Resource classification

The resource estimates have been classified in accordance with the JORC Code (2012 edition). In general, grade and geological continuity, data quality, drill coverage, and whether the material was likely to be mined were taken into consideration. Material was only included in the resource inventory if the following conditions were met. These conditions have been formulated to ensure that the material has a reasonable prospect of eventual economic extraction.

- Material was located in an area with a drill coverage of 200 x 200 m or smaller
- Combined thickness of the HC, BZ, and BC was at least 1 m
- Gravel was only included if the combined thickness of the HC, BZ, and BC was at least 1 m
- The following WDIE grade criteria were satisfied:
 - Greenstone: $A.Al_2O_3 > 24.0\%$ and $R.SiO_2 < 4.5\%$
 - Granite: $A.Al_2O_3 > 28.0\%$ and $R.SiO_2 < 4.5\%$
 - Gravel: $A.Al_2O_3 > 29.5\%$ and $R.SiO_2 < 4.5\%$
- For Greenstone models, the following drill spacing criteria were applied:
 - Measured: 100 x 50 m grid or smaller
 - Indicated: 200 x 100 m grid
 - Inferred: 200 x 200 m grid
- For Granite models, the following drill spacing criteria were applied:
 - Indicated: 100 x 50 m grid or smaller
 - Inferred: Grid spacings between 100 x 50 m and 200 x 200 m
- Blocks in areas where most drilling occurred prior to 2006 were downgraded to Inferred.

The above criteria were assigned on an individual block basis. For the Greenstone models, individual resource blocks surrounded by waste block were recoded as waste. BWAPL reports that only the $A.Al_2O_3$ and $R.SiO_2$ estimates form part of the Mineral Resource estimate.

3.7 Model validation

The model validation activities were primarily directed at assessing whether the model estimates were consistent with the input data. A summary description of the procedures conducted by BWAPL and the outcomes is presented below.

Visual validation: This entailed an on-screen comparison of the input sample grades and estimated model grades for the main variables. BWAPL reports good agreement between the datasets.

Statistical comparisons: The model and input dataset means and variances were compared on a global and regional basis. Where appropriate, declustering was performed to reduce any differences due to variable drill spacing. Scatterplots and quantile-quantile (QQ) plots were also prepared. Based on the results presented in the resource reports, there was generally good agreement for $A.Al_2O_3$, with the model estimates being within 5% (relative) of the input grades for most domains. $R.SiO_2$ generally reported poorer correlation for most domains. For the Greenstone models, the model and dataset means were generally within 10% of each other, whereas for the Granite models, the differences were usually between 10 - 20%, with some as high as 30%.

Swath plots: These were prepared by taking regularly spaced northing, easting, and elevation slices through the deposit in each domain and calculating the average model and sample grades. The results were presented as graphs of the average grades with the slice coordinates. The swath plots were supplemented by Scatterplots and QQ plots. In general, quite good correlation was observed in the swath plots included in the resource reports, with the grade trends evident in the input data adequately reproduced in the model. Some of the Granite model R.SiO₂ biases indicated by the statistical comparisons are also evident in the swath plots. Example swath plots are presented in Figure 3-5 and Figure 3-6.

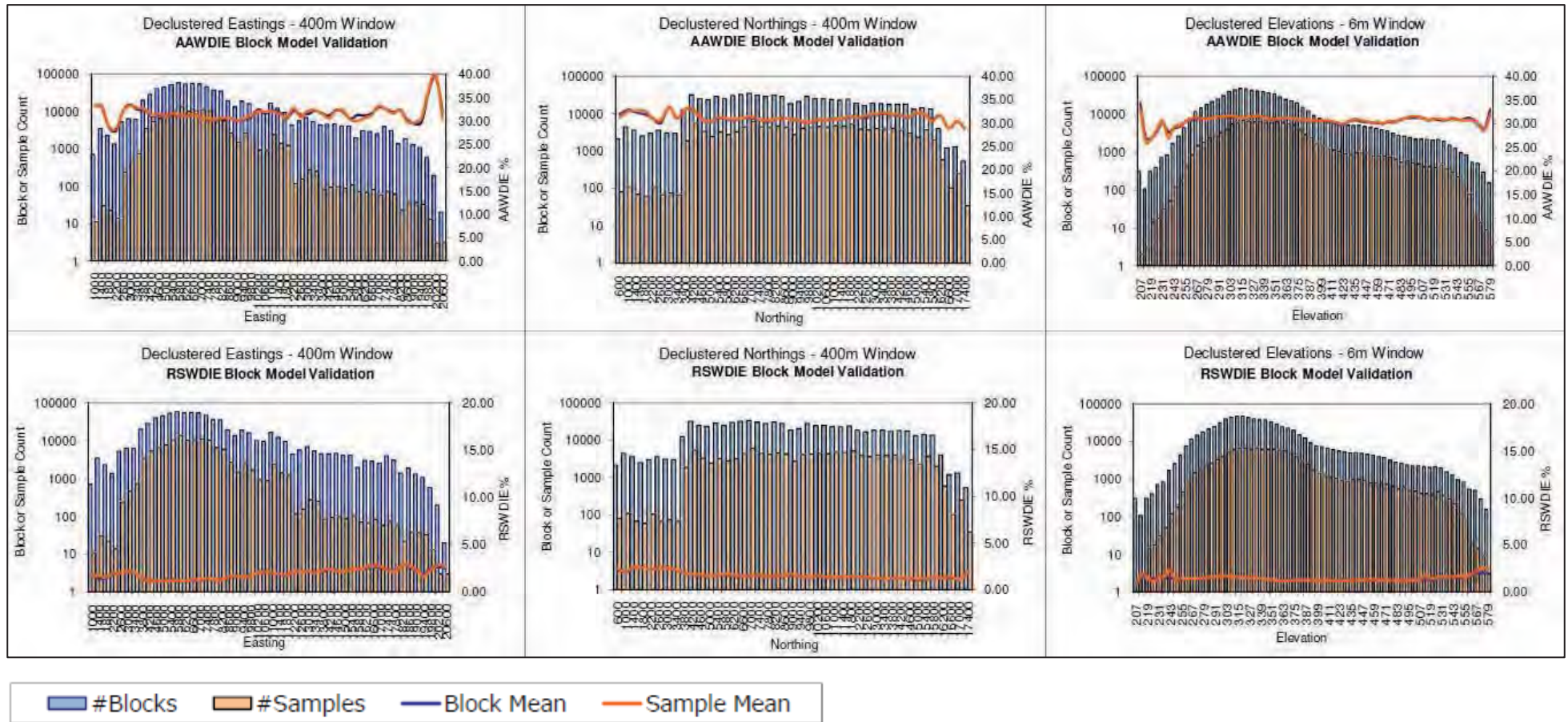

Figure 3-5: Example Greenstone swath plot – Saddleback bauxite zone (Ore zone)

Source: 117641060-003-R-Rev0-Saddleback_Resource_Estimation.pdf

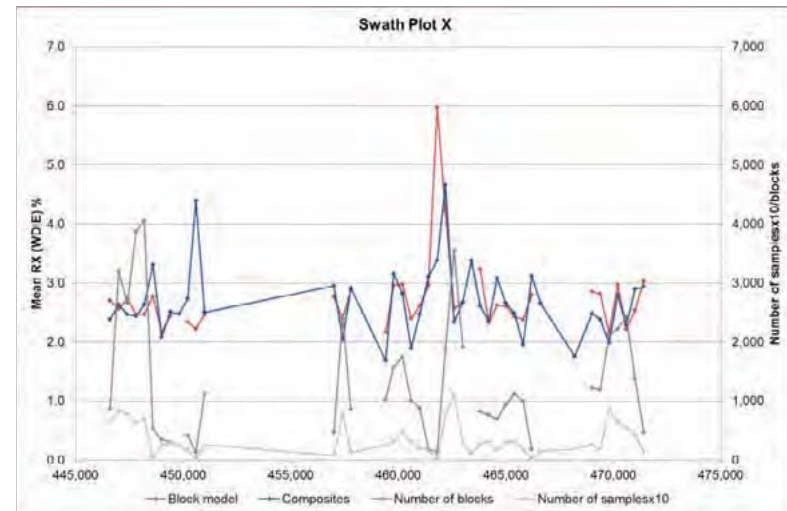
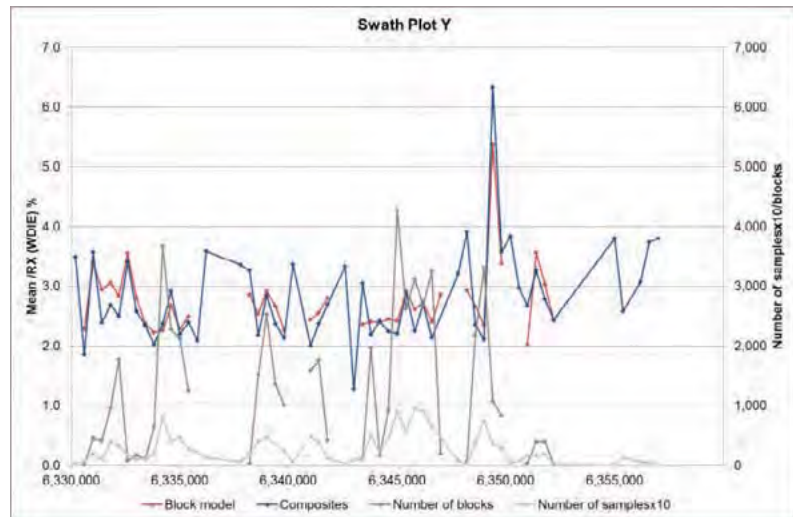
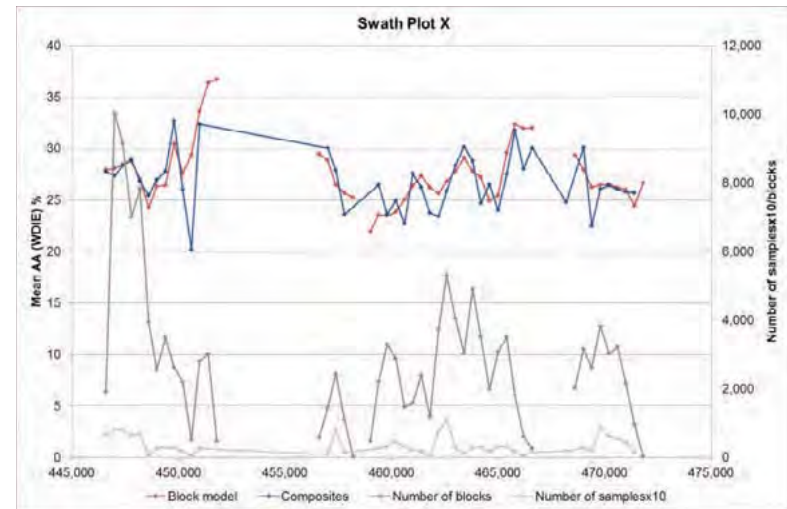
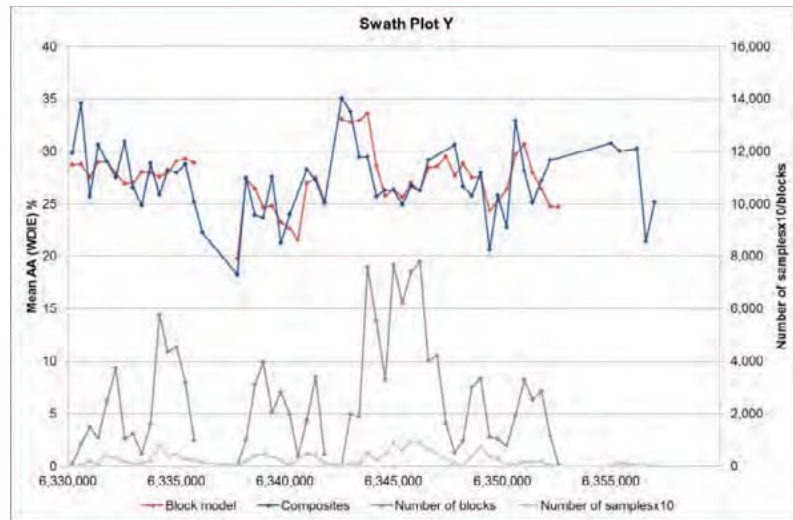

Figure 3-6: Example Granite swath plot – Hotham South bauxite zone

Source: HOS_WMS_MOR_Resource_Report_2014.docx

3.8 Audits

A list of the audits that have been performed on BWAPL 2014 resource estimates is presented below:

- BHP Billiton Group Resource and Business Optimisation: Internal Audit
- BHP Billiton Group Risk Assessment and Assurance: Internal Audit
- Xstract: Mid Central / Bannister East Resources Fatal Flaw Review
- Xstract: Hotham South / Williams South Morgan Resources Fatal Flaw Review
- Xstract: Hotham West Resources Fatal Flaw Review
- Coombes Capability: Mineral Resource Estimate Fatal Flaw Analysis, Collie.

The Xstract reviews did not identify any fatal flaws. Identified issues described as minor included the following:

- Grade-based domaining practices
- Shortcomings in QA datasets
- Possible bias between different sample preparation techniques
- Some inconsistencies with the variogram modelling and search parameters.

Coombes identified the following three issues that were deemed to warrant investigation:

- Use of WDIE data if WLAA is expected to better reflect refinery conditions
- Use of a single density value
- Limited information on sample recovery.

The recommendations from the internal reviews were primarily directed at improving the documentation and control on sample preparation and testing procedures and use of a simple density value.

BWAPL reports that the abovementioned issues are currently being investigated, or are planned to be investigated in 2015.

3.9 Reconciliations

Reconciliations were performed and reported in accordance with BHP Billiton Tenement Management, Exploration Results, Resource and Reserve Reporting procedures, which resulted in the derivation of the following reconciliation factors:

- F1: Grade Control to Ore Reserve Model (b/a)
- F2: Actual Process Plant feed to Grade Control predicted feed (c/b)
- F3: Final product inventory to Ore Reserves predicted (d/a) – expressed as tonnes of alumina.

Where:

a: resource and reserves model depletion (based on pit surveys)

b: grade control model depletion (based on pit surveys)

c: plant feed (based on pit survey and stockpile changes)

d: shipment (based on ship loader weights and sampling).

A summary of the reconciliation results for the past four years is presented in Table 3-6.

Table 3-6: Reconciliation summary

Parameter	Year	Tonnes	AAI ₂ O ₃	R.SiO ₂
F1	CY13	110%	97%	113%
F2	CY13	110%	101%	107%
F3 Alumina	CY13	121%		
F1	CY12	104%	102%	106%
F2	CY12	99%	100%	99%
F3 Alumina	CY12	107%		
F1	CY11	107%	109%	114%
F2	CY11	109%	111%	105%
F3 Alumina	CY11	120%		
F1	CY10	101%	100%	97%
F2	CY10	111%	111%	103%
F3 Alumina	CY10	107%		

3.10 Resource potential

Based on the current resource inventory, BWAPL has a predicted LOM that extends beyond 2080. For this reason, BWAPL’s main exploration focus is the systematic upgrading of the existing resources and not the identification of new deposits. Figure 3-7 shows the current resource inventory breakdown through to 2082. BWAPL has included a small amount of material that has not yet been defined as Resources.

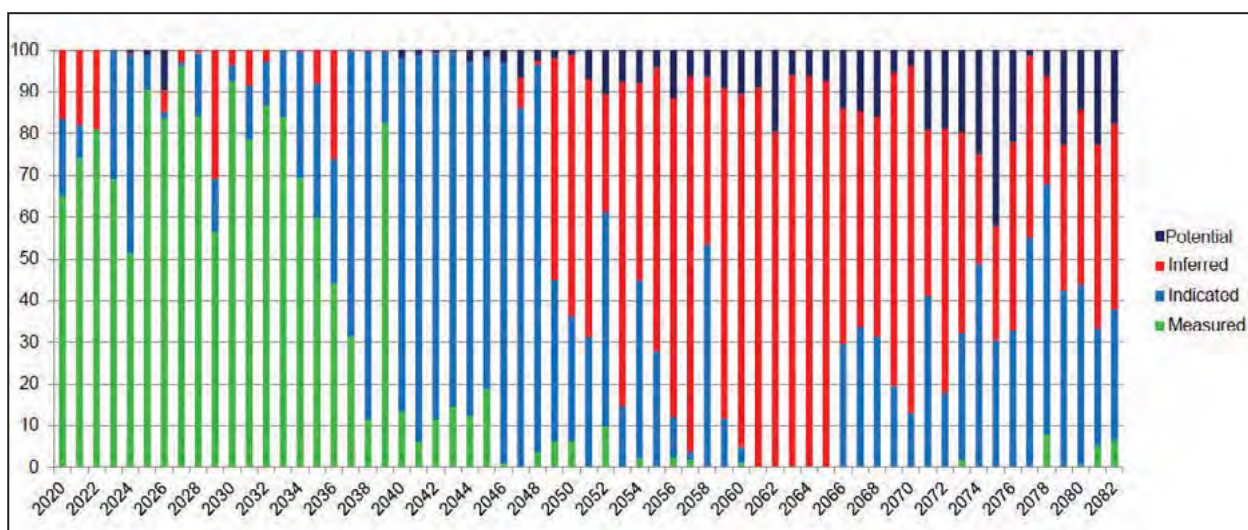

Figure 3-7: Predicted production based on current Resource classification

Source: BWAPL (2014)

3.11 Summary comments

SRK has not identified any significant issues with the BWAPL resource estimates and considers that they provide an accurate indication of the Mineral Resource. However, some aspects of the data collection and resource estimation procedures are considered to be sub-optimal, and these are discussed below.

Geology

Given the proximity to Perth and the long history of mining in the southwest of Western Australia, the regional geology of the Darling Ranges is well understood. The general geological hypotheses that BWAPL has used as the basis for exploration and resource delineation are consistent with those widely held in the industry. Bauxite has been mined and processed from the Worsley deposits for over 30 years, and BWAPL has a good understanding of the controls on mineralisation, and the mineralogical and physical properties of the bauxites. This understanding has been adequately incorporated into the resource modelling procedures.

Resource data

The quantity of data used to prepare the resource estimates is considered to be appropriate. The uncertainty associated with the resource estimates in areas covered by wider drill spacings is deemed to be adequately accounted for in the resource classification. The sample collection techniques are sub-optimal, but given that they appear to produce predictable results, they can be considered as being fit for purpose. Like many integrated bauxite and alumina operations, the analytical techniques are not aimed at quantifying absolute elemental concentrations, but instead at providing data that can be used to predict refinery performance. External audits highlighted some of these shortcomings with the data acquisition procedures. However, the long production history demonstrates that the implementation and periodic adjustment of these procedures can provide effective estimates of refinery performance.

Resource estimation

The current resource models have been prepared using techniques that are widely used in the industry. The validation results indicate that the models are broadly consistent with the input data. The reconciliation results indicate that the models provide an acceptable indication of production.

As indicated above, some of the data collection and resource estimation procedures are considered to be sub-optimal, and will introduce uncertainty and most likely bias into the estimates. Past reconciliation results have been used to devise adjustment factors that are applied to the resource estimates to assist with the prediction of production tonnages and grades. Given that these adjustment factors are not excessively large, the likelihood that any of data collection and estimation procedures are introducing significant errors is low, although it is likely that compensating errors exist.

Over the past several years, BWAPL has made a number of significant changes to improve the reliability of the data and estimation, with further changes planned. The acceptance and reliance on adjustment factors means that it is difficult to identify which of the data collection and estimation activities are the major sources of uncertainty. The extended timeframe between initial drilling and production, coupled with the practice of mining from 3 to 4 pits per shift and loading onto three 250 kilotonne (kt) chevron-stacked stockpiles, means that it is difficult to monitor the effects that incremental changes to the data collection and estimation activities may have on production.

The majority of the bauxite mined and processed to date has developed on greenstones. The bauxites that have developed on granites have different grade and physical characteristics to those developed on greenstone, and it is likely that the current factors that are used for production estimates will not apply when transitioning to the granite regions. This is not planned to occur until 2038, and BWAPL is confident that the differences in processing characteristics will be identified and resolved prior to then.

Based on descriptions of the procedures and site observations, SRK considers the activities listed below are likely to be the main sources of uncertainty in the resource estimates:

- **Drill sample extraction:** As evidenced by the excessive recoveries reported by BWAPL, the vacuum drill samples would not meet the definition of “sample correctness” (as defined by Gy). Given the significant amount of oversampling reported since monitoring commenced in early 2014, and the heterogeneous nature of the bauxite (hard, variably-sized pisolites in a clayey matrix), preferential sampling is quite likely, and grade bias is possible. The current QA/QC procedures do not contain any mechanism to detect whether biases were introduced during the initial sample extraction process.
- **Density:** The use of a single *in situ* dry bulk density value appears to have enabled an acceptable prediction of the resource tonnages that will be delivered to the refinery. However, given the variation in the mineralogy and physical properties of the various horizons (particularly Fe grade and compaction/ porosity characteristics), the local tonnage estimates are likely to be unreliable. The current default value may not be appropriate for the Granite model bauxites, which have lower Fe grades and lower Hardcap: B Zone thickness ratios.
- **Resource modelling:** BWAPL has made many incremental improvements to the modelling procedures over the past several years, including moving from a 2D approach to the current kriged 3D block model. A summary of some aspects of the modelling that may introduce bias or uncertainty is presented below:
 - Folding the lithologies to the topography is an improvement over a point to point linking of drill intercepts. However, it would be preferable to fold the lithologies to a surface that represents the topography at the time of bauxitisation. Given the variable thicknesses of overburden and gravel, this is unlikely to be the current topographic surface. The smoothed (pre-erosional) top of the hardcap may be a better choice.
 - Most of the lithological contacts are thought to be gradational, and the domain boundaries have been largely defined using cut-offs applied to sample grades. The quality assurance data indicates relatively poor precision for R.SiO₂, which could lead to uncertainty in the actual position of the boundary as well as bias in the estimated domain grades. For the Greenstone models, this issue is likely exacerbated by the use of the ore / waste sub-domains. For the Granite models, the use of large vertical search distances (in lieu of unfolding) to account for the elevation changes effectively likens it to a 2D estimate. It would be preferable to use an estimation approach that reproduces the vertical grade profile evident in the sample data, and to then use the estimated block grades and not the sample grades to define the base of the resource.
- **Reconciliation:** The reconciliation results for the past three years indicated that the resource estimates under-call alumina production by approximately 10%. The bulk of this appears to be due to additional material mined, and the under-call for R.SiO₂ indicates that this is likely a result of deeper mining.

4 Ore Reserve

4.1 Introduction

The BWAPL Ore Reserves are limited to the PBA. The PBA is the area of the State Agreement Mining Lease 258SA (ML258SA) for which State Government environmental approvals to mine the bauxite have been received. Figure 4-1 shows the PBA area (dark blue line).

Mineral Resources inside the PBA limits only, can be converted to Ore Reserves after applying the mining and processing modifying factors, as per the JORC Code 2012 requirements.

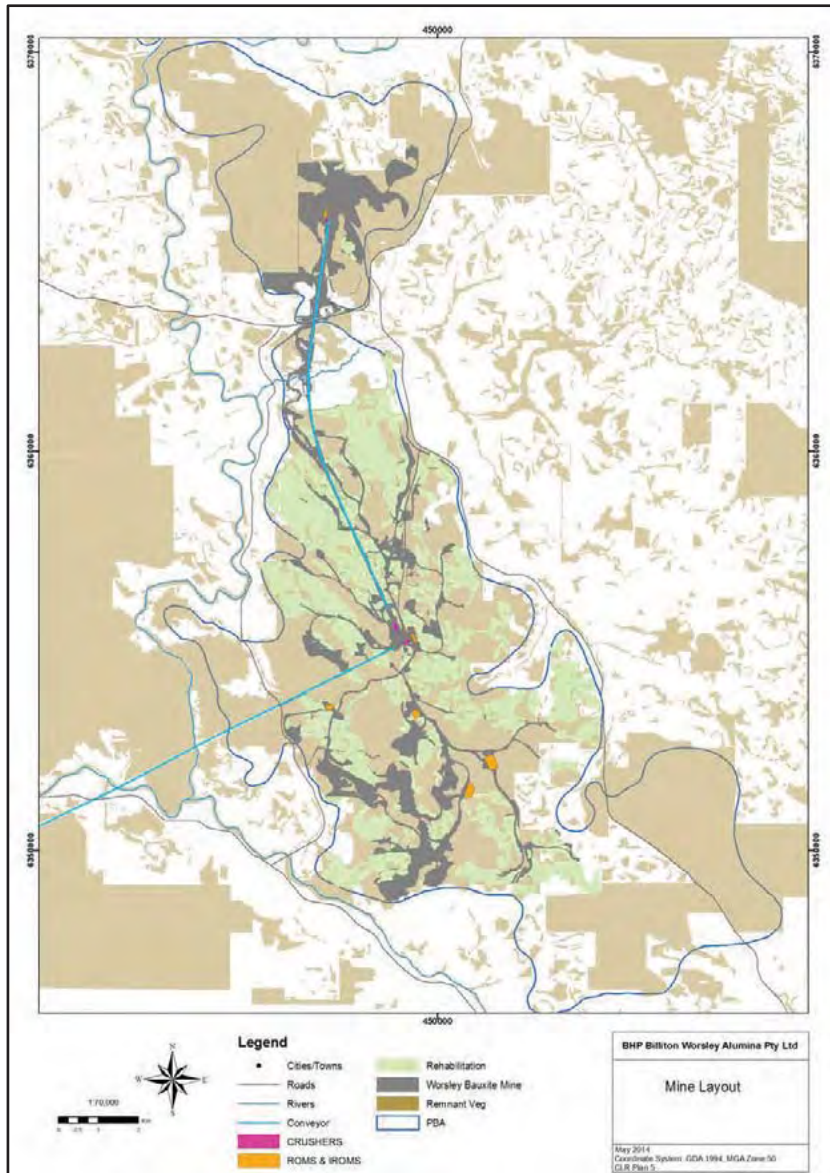

Figure 4-1: Boddington Bauxite Mine – Primary bauxite area (dark blue line)

Source: BWAPL (2014)

4.2 Optimisation parameters

Cut-off grade parameters applied during the Mineral Resource estimation (MRE) and Ore Reserve estimation process are based on achieving the acceptable alumina refinery head grade requirements for AAI_2O_3 and $RSiO_2$. The alumina commodity price, refinery recovery and overall operating costs

are not used to determine the required cut-off grade parameters for the bauxite mined. The long-term target feed specification for the Worsley Alumina Refinery is 30.7% AAI_2O_3 .

Cut-off grades are applied per specific lithological units and are as follows:

- Gravel horizon 29.5% AAI_2O_3 (on WDIE basis) and less than 3% $RSiO_2$ (on WLAA basis)
- Hardcap horizon 24.0% AAI_2O_3 (on WDIE basis) and less than 3% $RSiO_2$ (on WLAA basis)
- B zone horizon 24.0% AAI_2O_3 (on WDIE basis) and less than 3% $RSiO_2$ (on WLAA basis).

As part of the Ore Reserve declaration process, a test to determine whether the planned extraction sequence is cash flow positive is performed.

Only Measured Resource material and Indicated Resource material, satisfying the cut-off criteria and satisfying all the modifying factors, that can be mined economically are included in the Ore Reserves.

4.3 Modifying factors

The mining of bauxite within the PBA has been performed at BBM over the past 30 years. Mining typically takes place in shallow to very shallow open pits, whereby a few open pits are mined simultaneously (typically 3 to 4 pits) to ensure that the blended alumina feed grade can be obtained by mixing directly from the active mining faces. In addition, stockpiles are used to even out minor grade variations, prior to feeding the bauxite material to the alumina refinery.

The parent cell size for the Mineral Resource block model is 25 m (X) by 25 m (Y) in plan, by 3 m in the vertical direction (Z). This model is re-blocked for top and bottom surface modelling purposes into 5 m (X) by 5 m (Y) in plan, by 1 m in the vertical direction (Z).

The modelled top and floor surfaces are converted into a 2D block model with 25 m by 25 m plan view dimensions, which allows the thickness of the various units of waste, interburden and ore (above minimum cut-off grades for AAI_2O_3 and below cut-off grades for $RSiO_2$) to be determined. This model will also facilitate the determination of stripping ratios and other mining factors.

Waste hardcap material in excess of 1 m thickness will be mined separately by BBM as waste and disposed of in nearby mined-out pits. Where the waste hardcap is less than 1 m thick, it will be mined as diluting material (planned dilution), together with the bauxite profile earmarked for extraction. Interburden (lower grade material below cut-off parameters) within the bauxite profile of less than 2 m thickness is included in the bauxite profile as planned dilution.

A maximum limiting slope angle of 17° is used by BBM to determine the mineable Ore Reserves. Blocks with topography angles in excess of 17° are not included in the mineable Ore Reserves.

A selective mining unit (SMU) of 30 m in the horizontal X and Y directions is used, with a minimum of 1 m in the vertical Z direction. Grade control drilling is done on a horizontal nominal 25 m grid spacing. The vertical minimum limit of 1 m is based on the vertical selectivity of the backhoe excavator bucket (being able to mine waste and ore selectively in the vertical direction). A minimum mining width (MMW) of 30 m is used for the operating benches.

Based on historical reconciliation figures, a mining recovery of 100% is used for the production scheduling of the Ore Reserve and for the Ore Reserve declaration of the mining inventory blocks which satisfy the selection criteria.

Prior to the Measured Resource and Indicated Resource material being converted to Ore Reserves, a list of exclusion criteria are applied to the block model, whereby blocks that are falling within the exclusion constraints are removed from the mineable inventory and therefore do not form part of the Ore Reserve.

SRK is of the opinion that the exclusion criteria are a reasonable reflection of practical mining conditions and limitations in accessing the bauxite mineralisation.

4.4 Ore Reserve statement

Table 4-1 presents the 30 June 2014 summary of declared Ore Reserves for BWAPL. Table 4-2 presents a detailed breakdown of the 30 June 2014 Ore Reserve statement by area. The Ore Reserves numbers are restated by SRK for the expected end of December 2014 position. It should be noted that numbers have been rounded to the nearest million dry tonne (Mdt).

Table 4-1: Summary Ore Reserve statement – 30 June 2014

End June 2014	Proved Reserve			Probable Reserve			Total Ore Reserve		
	Mass	Grade	Grade	Mass	Grade	Grade	Mass	Grade	Grade
	Mdt	AAI ₂ O ₃	RXSiO ₂	Mdt	AAI ₂ O ₃	RXSiO ₂	Mdt	AAI ₂ O ₃	RXSiO ₂
Granite derived	52	31.3	2.3	2.0	31.2	2.5	54.0	31.3	2.3
Greenstone derived	222	31	1.4	20	30.2	1.6	242	30.9	1.4
Total	274	31.1	1.6	22	30.3	1.7	296	31.0	1.6

Table 4-2: Ore Reserve statement – 30 June 2014 (by area)

Granite derived									
Area	Proved Reserve			Probable Reserve			Total Ore Reserve		
	Mass	Grade	Grade	Mass	Grade	Grade	Mass	Grade	Grade
	Mdt	AAI ₂ O ₃	RXSiO ₂	Mdt	AAI ₂ O ₃	RXSiO ₂	Mdt	AAI ₂ O ₃	RXSiO ₂
Saddleback	35	31.3	2.2	2	31.2	2.5	37	31.3	2.2
Marradong	8	32.7	2.3	0	29.4	3.0	8	32.7	2.3
Hotham north	9	30.3	2.6	0	27.6	2.5	9	30.3	2.6
Total	52	31.3	2.3	2	31.2	2.5	54	31.3	2.3
Greenstone derived									
Area	Proved Reserve			Probable Reserve			Total Ore Reserve		
	Mass	Grade	Grade	Mass	Grade	Grade	Mass	Grade	Grade
	Mdt	AAI ₂ O ₃	RXSiO ₂	Mdt	AAI ₂ O ₃	RXSiO ₂	Mdt	AAI ₂ O ₃	RXSiO ₂
Saddleback	53	28.7	1.3	4	31.5	1.9	57	28.9	1.3
Marradong	46	31.5	1.2	4	29.5	1.8	50	31.3	1.3
Hotham north	123	31.8	1.5	12	30	1.5	135	31.6	1.5
Total	222	31.0	1.4	20	30.2	1.6	242	30.9	1.4
All Bauxite									
Area	Proved Reserve			Probable Reserve			Total Ore Reserve		
	Mass	Grade	Grade	Mass	Grade	Grade	Mass	Grade	Grade
	Mdt	AAI ₂ O ₃	RXSiO ₂	Mdt	AAI ₂ O ₃	RXSiO ₂	Mdt	AAI ₂ O ₃	RXSiO ₂
Saddleback	88	29.7	1.7	6	31.4	2.1	94	29.8	1.7
Marradong	54	31.7	1.4	4	29.5	1.8	58	31.5	1.4
Hotham north	132	31.7	1.6	12	30	1.5	144	31.6	1.6
Total	274	31.1	1.6	22	30.3	1.7	296	31.0	1.6

Source: BWAPL (2014)

SRK has independently verified the Ore Reserves for BWAPL and agrees with the BWAPL Ore Reserve statement. Mining operations are currently undertaken at the Marradong and Saddleback areas only. The Hotham North area has not been accessed for mining.

4.5 Historical Ore Reserve statements

Table 4-3 to Table 4-5 present the past three years historical Ore Reserve Summary statements for BWAPL.

Table 4-3: Ore Reserve statement - 30 June 2013

End June 2013	Proved Reserve			Probable Reserve			Total Ore Reserve		
	Mass	Grade	Grade	Mass	Grade	Grade	Mass	Grade	Grade
	Mdt	AAI ₂ O ₃	RXSiO ₂	Mdt	AAI ₂ O ₃	RXSiO ₂	Mdt	AAI ₂ O ₃	RXSiO ₂
Granite derived	51	31.5	2.4	2.0	31.2	2.7	53.0	31.5	2.4
Greenstone derived	200	31	1.6	48	30.5	1.8	248	30.8	1.7
Total	251	31.0	1.8	50	30.5	1.8	301	30.9	1.8

Table 4-4: Ore Reserve statement - 30 June 2012

End June 2012	Proved Reserve			Probable Reserve			Total Ore Reserve		
	Mass	Grade	Grade	Mass	Grade	Grade	Mass	Grade	Grade
	Mdt	AAI ₂ O ₃	RXSiO ₂	Mdt	AAI ₂ O ₃	RXSiO ₂	Mdt	AAI ₂ O ₃	RXSiO ₂
Granite derived	51	31.7	2.4	2.0	30.4	2.4	53.0	31.6	2.4
Greenstone derived	211	31	1.6	47	30.6	1.7	258	30.9	1.7
Total	262	31.1	1.8	49	30.6	1.8	311	31.0	1.8

Table 4-5: Ore Reserve statement - 30 June 2011

End June 2011	Proved Reserve			Probable Reserve			Total Ore Reserve		
	Mass	Grade	Grade	Mass	Grade	Grade	Mass	Grade	Grade
	Mdt	AAI ₂ O ₃	RXSiO ₂	Mdt	AAI ₂ O ₃	RXSiO ₂	Mdt	AAI ₂ O ₃	RXSiO ₂
Granite derived	40	31.0	2.3	3.0	30.9	2.1	43.0	31.0	2.3
Greenstone derived	199	31	1.7	57	30.4	1.7	256	31.0	1.7
Total	239	31.1	1.8	60	30.4	1.8	299	31.0	1.8

Source: BWAPL (2014)

4.6 Ore Reserve statements (SRK Depleted)

Table 4-6 presents the Ore Reserves (SRK Depleted) as estimated for 31 December 2014. This estimate has been prepared on the basis of SRK verifying the 30 June 2014 base Ore Reserve estimate and applying Depletions up to 31 December 2014. Actual production for July to October 2014 and BWAPL provided estimates for November and December 2014 have been used.

Table 4-6: Ore Reserve statement (SRK Depleted) – 31 December 2014

30 June 2014	Proved Reserve			Probable Reserve			Total Ore Reserve		
	Mass	Grade	Grade	Mass	Grade	Grade	Mass	Grade	Grade
	Mdt	AAI ₂ O ₃	RXSiO ₂	Mdt	AAI ₂ O ₃	RXSiO ₂	Mdt	AAI ₂ O ₃	RXSiO ₂
Granite derived	52	31.3	2.3	2.0	31.2	2.5	54.0	31.3	2.3
Greenstone derived	222	31	1.4	20	30.2	1.6	242	30.9	1.4
Total	274	31.1	1.6	22	30.3	1.7	296	31.0	1.6

Depletion	Proved Reserve			Probable Reserve			Total Ore Reserve		
	Mass	Grade	Grade	Mass	Grade	Grade	Mass	Grade	Grade
	Mdt	AAI ₂ O ₃	RXSiO ₂	Mdt	AAI ₂ O ₃	RXSiO ₂	Mdt	AAI ₂ O ₃	RXSiO ₂
June to October 2014 (actuals)	4.6	32.1	1.2	0	0	0	4.6	32.1	1.2
November to December 2014 (estimates)	2.9	30.3	1.5	0.0	0.0	0.00	2.9	30.3	1.5
Total	7.5	31.4	1.29	0.00	0.00	0.00	7.5	31.4	1.3

31 December 2014	Proved Reserve			Probable Reserve			Total Ore Reserve		
	Mass	Grade	Grade	Mass	Grade	Grade	Mass	Grade	Grade
	Mdt	AAI ₂ O ₃	RXSiO ₂	Mdt	AAI ₂ O ₃	RXSiO ₂	Mdt	AAI ₂ O ₃	RXSiO ₂
Granite derived	52	31.3	2.3	2	31.2	2.5	54	31.3	2.3
Greenstone derived	214.5	31.0	1.4	20	30.2	1.6	234	30.9	1.4
Total	266.5	31.1	1.6	22	30.3	1.7	288.5	31.0	1.6

The remaining BWAPL Ore Reserves as at 31 December 2014 are 288.5 Mt, and based on a feed rate of approximately 18 Mtpa to the alumina refinery, to produce nameplate capacity of 4.66 Mtpa of alumina, represents a LOM of approximately 15.5 years for BWAPL, from 2015. SRK has independently verified the Ore Reserves for the BWAPL operation and agrees with the BWAPL Ore Reserve statement.

Note:

This report includes information on Ore Reserves as reported by G Burnham (MAusIMM). The information is extracted from the report titled BHP Billiton 2014 Annual Report and is available to view on www.bhpbilliton.com.

All Competent Persons are full-time employees of BHP Billiton at the time of reporting and have the required qualifications and experience to qualify as Competent Persons for Mineral Resources under the 2012 Edition of the "Australasian Code for Reporting of Exploration Results, Mineral Resources and Ore Reserves" (JORC Code). The Competent Persons verify that the report is based on and fairly reflects the Ore Reserves information in the supporting documentation and agree with the form and context of the information presented.

BHP Billiton confirms that it is not aware of any new information or data that materially affects the information included in the original market announcements and, in the case of estimates of Ore Reserves that all material assumptions and technical parameters underpinning the estimates in the relevant market announcements continue to apply and have not materially changed. BHP Billiton confirms that the form and context in which the Competent Persons' findings are presented have not been materially modified from the original market announcements.

The Ore Reserves breakdown by classification (100% basis) are contained in Table 4-1. All tonnes and quality information has been rounded, hence small differences may be present in the totals.

5 Geotechnical Engineering

5.1 Settings

BWAPL's mine lies within the Saddleback Greenstone Belt, the uppermost unit of which is the Marradong Formation basalt. Overlying bedrock is a well-developed regolith profile up to 40 m in thickness. Mining occurs in the uppermost 10 - 20 m below surface.

The upper clay zone overlain by the laterite cap has the potential to generate seasonal perched groundwater levels - the "Shallow Aquifer". A "Lower Saprolite Aquifer" is present immediately above the bedrock at depths between 15 m and 40 m (generally well below mining depth). Groundwater levels within the aquifers broadly mirror the topography.

5.2 Slope stability

The mining at BWAPL is very shallow (<10 m - 20 m depth). Batters are 9 m in vertical height separated by benches of 3 m width. Over these limited heights, the cohesive material is stable, with stand-up times exceeding decades in duration, and slope stability issues have not occurred in the past.

Limited areas of perched groundwater encountered dissipate upon blasting.

5.3 Summary comments

No significant geotechnical conditions exist at BWAPL. The shallow mining, limited batter heights, cohesive nature of the materials in which mining is taking place and absence of groundwater for material saturation have not resulted in any instability problems in the past, with batters displaying long stand-up times.

6 Hydrology and Hydrogeology

6.1 Hydrology

6.1.1 Physical setting

The BWAPL refinery and mining area are situated in a typical Mediterranean climatic region, comprising cool wet winters and hot dry summers.

Annual rainfalls in the mining area lie in the range 800 to 900 mm. The driest month is January, with most precipitation falling between May and August. Evapotranspiration (comprising canopy interception, plant transpiration and soil evaporation) can account for up to 97% of the incident rainfall.

The average annual rainfall for the refinery over the monitoring period (1980 to 2013) is 1,070 mm, and the average annual evaporation rate of 1,422 mm.

The mining area lies within the following river catchments; Murray River, Serpentine River, Canning River, Lower Swan, and Main Avon catchments. These catchments, all in the Darling Plateau, are characterised by sharply incised, dense drainage networks in the west (higher rainfall area) and by flat-floored valleys in the east (lower rainfall area). The Darling Plateau is naturally forested, and the runoff in the area is generally correlated with rainfall, varying from 15 - 25% of rainfall in the highest rainfall area to less than 1% of rainfall in the lowest.

The refinery lease area is located in the headwaters of the Augustus River system, a sub-catchment of the Brunswick River.

6.1.2 Water supply

Mine

The current annual operational demand of the bauxite mine is ~450 megalitres (ML). This is met predominantly through groundwater extraction, with opportunistic use made of surface water collection for augmentation of supplies to meet dust suppression requirements. This is restricted to collection of runoff from compacted areas such as workshop facilities within the mining operation. Approximately 340 ML/a of the total mine demand is used in dust suppression on haul roads and plant site.

All workshop wastewater is recovered and released to the Karafil Dam, from where it is used for dust suppression on haul roads. A sump collects recycled water from the crusher and reclaim area; this water is also used for haul road dust suppression.

The use of surface water for supply to the Mine has been impacted by an extended period of low flows in the Saddleback Timber Reserve mine operational area over the past decade. This is due to the characteristically low yields in the area, in combination with a below average rainfall period.

However, as the mine expands, alternative options to augment supply would include consideration of surface water sources. The general options for developing surface water supplies that are to be considered include the following:

- Upgrading of existing mine site dams and sumps (with an emphasis on minimising losses)
- Construction of new mine site dams and sumps
- Construction of pipehead dams on streams to divert stream flow to a separate storage facility
- Construction of large dams and storage reservoirs on creeks or streams.

Preferred future options for the sourcing of surface waters will depend on the local situation and factors such as prevailing topography, stream flow and stream water quality characteristics, etc. The specific options are as follows:

- **Hotham River:** The Hotham River represents a large water resource in close proximity to the existing mining operations in the Saddleback and Marradong areas. Flows are strongly seasonal (winter dominated) with considerable variation both seasonally and year on year, requiring off-stream storage. Water quality could also be an issue even if the water is used in dust suppression.
- **Newmont Boddington Gold Mine:** Planned mining operations at the Boddington Gold Mine by Newmont will generate large volumes of water, from pit dewatering and runoff from waste and mine areas, that is normally discharged to the Hotham River. Options to integrate operational strategies of BWAPL mine and the Boddington Gold Mine to mutual benefit is an option for consideration.
- **Integrated Water Supply System:** The Water Corporation has indicated a supply in the order of 120 kL/day (43 ML/a) could be provided to the BWAPL mine from the Integrated Water Supply System. It is likely that water would be of potable quality and its preferred use would be as a potable supply for the offices and ancillary works rather than for haul road dust suppression.

It should be noted that surface water is opportunistically collected at the mine and that groundwater is the primary source of process water.

Refinery

The current fresh water demand of the BWAPL Refinery is between 2.3 and 2.5 gigalitres (GL)/a, having risen from ~1.8 GL/a in 2004. The major requirements are for the powerhouse cooling tower, demineralisation plant, Bayer firewater and domestic water systems, and the bauxite residue disposal area (BRDA) for construction and dust suppression.

The Refinery water management system separates the Refinery Lease Area into two catchments in order to control the quality of groundwater and surface water systems and ensure that Refinery activities and associated processes do not influence water quality detrimentally:

- A clean water catchment in which non-contaminated surface water runoff is directed to the Freshwater Lake (FWL). The FWL discharges to the Brunswick River system via the Augustus River.
- A closed system high-contamination risk catchment to contain process liquors and other contaminated waters into the Refinery Catchment Lake (RCL).

The FWL is used to supply potable water, water for Bayer process activities, powerhouse cooling water and make-up water to the RCL. Discharge from the Refinery lease area is uncontaminated and released to the Augustus River, subject to seasonal conditions and the FWL inventory. There is also a downstream ecological water requirement which is released to the Augustus River with the discharge determined by the environmental management plan.

The RCL is used for cooling purposes at the BWAPL Refinery and Powerhouses and as make-up liquor for the Bayer process. The RCL collects runoff from the Refinery, seepage decant water and runoff from the bauxite residue disposal areas. Any water that enters this system is assumed to be contaminated and therefore not released from the system. Pipehead dams which receive underdrainage and decant water from the BRDAs are also components of this closed system and discharge to the RCL.

There are also independent solar evaporation ponds that are part of the water management system. These are used to contain spent sulphuric and hydrochloric acids.

6.1.3 Water balance

Given the physical context of both the Refinery and Mining areas, BWAPL has noted and included on the Material Risk Register, the potential for the incidence of both extremes of water balance – both positive and negative – to occur over the LOM. With a positive water balance, the risk arises of uncontrolled release of contaminated water, and with a negative water balance, severe water shortage can be a possibility. This arises from a combination of increased rainfall variability, long-term annual rainfall decline and larger BRDA surface areas, affecting catchments and the associated runoff behaviour. Each of these situations has been identified as a material risk to the business, and active steps are under way to address these risks. Plans to manage the Material Risk and provide support to long-term BRDA planning by addressing these water balance risks include the following:

- Work to investigate possible use of solar evaporation ponds for additional storage
- Construction of a second emergency storage facility (RCL 2)
- Increase the capacity of the Refinery FWL
- Dry cooling for condensing turbines
- Dry (air) condensers for process flash vapour
- Volume trimming and condensate usage to supplement cooling tower and firewater operations
- Investigate viability of water discharge off-site to address water excess.

6.1.4 Surface water supply licences

A surface water licence was issued with effect from 19 April 2013 [SWL68041(4)] for the Refinery FWL. The licence allows BWAPL to take 2.6 GL annually over the period 26 April 2013 to 8 October 2018, subject to the following:

- Average annual draw not to exceed 2.6 GL
- Maximum take of 5.4 GL in any one year.

The licence stipulates requirements for BWAPL to report on monthly usage and annual volumes, surface water monitoring details (including laboratory testing, flow and water levels) at Hamilton River Gauging Station, FWL Pump Station, Augustus River Gauging Station, at specified recording intervals). BWAPL is also committed to a transitional release strategy to protect the biodiversity downstream of the FWL Dam.

6.1.5 Data monitoring - Surface water

Compliance

Compliance obligations related to the use of surface water by the Mine and Refinery are addressed by the “Environmental Management Plan for Water Resources”. This management plan has been prepared in accordance with the requirements of Proponent Commitment 1 of Ministerial Statement No. 719 relating to the approval of the expansion of BWAPL’s bauxite mining operations.

Compliance reporting is required at the end of every fiscal year covering the preceding 12-month period in the Annual Environmental Report. This management plan is also audited and reviewed every three years and a performance assessment conducted every five years in accordance with Condition 5 of Statement No. 719.

Mine

Baseline surface water assessment is carried out through a sampling program designed to measure water quality and quantity. Other ongoing surface water monitoring in line with licence compliance includes water quality monitoring of streams of interest in the vicinity of new mining and bauxite transport areas.

Where any monitoring indicates adverse or unexpected environmental impacts, BWAPL will advise Department of Environment Regulation (DER) of the matter and the measures which have been taken and are intended to be taken to ameliorate any adverse environmental consequences.

Refinery

Collection of surface water data at the Refinery includes:

- Meteorological data
- Surface water monitoring commenced within the Worsley Lease Area in 1980, four years prior to the commencement of refining operations to provide baseline data that has been used to evaluate seasonal trends in water quality
- Baseline and ongoing annual monitoring of hydrological data is underway as part of the environmental management of the transition to a modified flow regime for the Augustus River.

6.1.6 Surface water - Emergency response plans

Management and emergency response plans are in place to address drainage, spills management and hazardous materials. These plans are reviewed against monitored data and where relevant, emergency plans are initiated in response to exceedance of specified trigger levels.

6.1.7 Summary comments

The following observations are made with respect to surface water management at the Refinery and Mine sites:

- The physical setting, particularly the low rainfall, high evaporation and forested catchments, present some substantial challenges to water management.
- The potential for mining activity (forest clearing and rehabilitation) to alter runoff behaviour is high; this can affect both the operational supply and the local environment.
- Sound responses and management approaches are in place to address these challenges.
- Existing supplies are secure and sound planning is in place with ongoing review of alternative supply options based on both historical usage records and long term demand forecasts. Water supply alternatives at the mine for future expansion include possible options to develop surface water sources to augment existing supplies, based mainly on groundwater.
- The surface water data monitoring program and associated reporting systems to comply with statutory obligations are mature and run efficiently.

6.2 Hydrogeology

6.2.1 Hydrogeological environment

The hydrogeology of the BBM mine and Worsley Refinery areas is similar. Three groundwater systems (aquifers) occur beneath these areas as follows:

- 1 A shallow weathered zone aquifer (shallow aquifer)
- 2 A deep weathered zone aquifer (lower saprolite)
- 3 A bedrock aquifer.

The shallow aquifer is a perched water table that only forms during relatively wetter conditions, but drains rapidly. The lower saprolite is the principal aquifer that rests on the bedrock. The bedrock aquifer occurs at depth. Groundwater in the bedrock aquifer occurs in fractures.

6.2.2 Dewatering status

There is no dewatering of groundwater at the BBM as the more substantial occurrences of groundwater are well below the depth of mining.

6.2.3 Water management

Five borefields, comprising 25 groundwater production bores that exploit two aquifer systems, provide groundwater for dust suppression and potable drinking purposes at the BWAPL Mine. The estimated volume of water required for dust suppression and potable drinking purposes is 450 megalitres per year (ML/a), with 340 ML/a being for dust suppression. All production bores are located within the BWAPL mining lease boundary.

As the existing and proposed mining areas are not located within a groundwater area proclaimed under the Rights in Water and Irrigation Act 1914, a Groundwater Well Licence (GWL) from the Department of Water (DoW) is not required. If a groundwater management area was proclaimed over an area that included a borefield(s), a GWL would need to be obtained from the DoW.

A Water Resources Management Plan – Mining (the Plan) has been prepared to ensure the protection of groundwater resources from adverse effects of its mining operations. The Plan includes a number of monitoring commitments. Every three years, an external review of the monitoring data collected over that period is conducted to assess compliance against the Plan and to assess trends and/or impacts on the groundwater resources due to extraction of groundwater. The last external review was conducted by Groundwater Resource Management in 2012 (GRM, 2012).

A substantial groundwater monitoring network and program has been established at the Collie Refinery to meet the conditions of the refinery's surface water licence. External hydrological reviews are conducted annually in accordance with the Alumina Refinery (Worsley) Act 1973 (as amended) and the conditions of the refinery's surface water licence.

The most recent external hydrological review (GRM, 2014) concluded that water quality and groundwater levels had not changed significantly since the commencement of refining operations, other than in a few areas. A technical internal audit conducted in late 2013 (BHP Billiton, 2014) found that the risk of groundwater contamination extending beyond the refinery operational boundary was considered low, although the effectiveness of the groundwater monitoring network, program and associated controls was being compromised by a lack of action taken to address recommendations from hydrological studies and contamination reports.

6.2.4 Operating and capital expenditure

Current annual groundwater maintenance and monitoring operational costs are shown in Table 6-1.

Table 6-1: Current annual maintenance and monitoring operational costs

Site	Item	Cost (A\$M)
Boddington Bauxite Mine (borefields)	Maintenance	0.7
	Monitoring	0.15
Collie Refinery (groundwater monitoring network and program)	Maintenance	0.17
	Monitoring	0.04
Total		1.06

6.3 Summary comments

The BBM and Worsley Refinery have established management systems and monitoring programs that regularly review the following:

- Security, availability and sustainability of local groundwater resources to meet site water demands.
- Potential adverse impacts from refining operations in order to assess the efficacy of control measures to ensure the protection of groundwater resources from the sites operations.

No substantial risks to groundwater security, availability and sustainability, or adverse impacts to groundwater resources have been identified from these regular reviews.

7 Mining Engineering

7.1 Introduction

Construction of the BBM, as part of the BWAPL integrated operations, started in 1980. The first alumina was produced in 1984.

The BBM is located in the south west of Western Australia (WA). Bauxite mining takes place in the State Forest on the eastern edge of the Darling Range, near Boddington, using shallow open pit mining methods, from a number of open pits, over extended areas.

The main tenement lease areas are the State Agreement Mining Lease 258SA (ML258SA) and a sublease area from Alcoa of Australia Ltd (Alcoa) of a portion of State Agreement Mining Lease 1SA (ML1SA). Figure 7-1 shows the PBA inside the ML258SA in purple and the ML1SA sub-lease in a dotted red line. The PBA is the area where State Government environmental approval to mine bauxite has been granted. Currently all the BBM mining operations take place inside the PBA limits. The majority of the FY2014 BBM operations are in the Marradong and Saddleback areas. All Ore Reserves listed in this CPR are inside the PBA.

SRK visited the mining operations at BBM, on 22 and 23 October 2014, in the Marradong and Saddleback areas.

There are currently two mining areas at BBM, the Saddleback Mining Envelope (SME) and the Marradong Mining Envelope (MME).

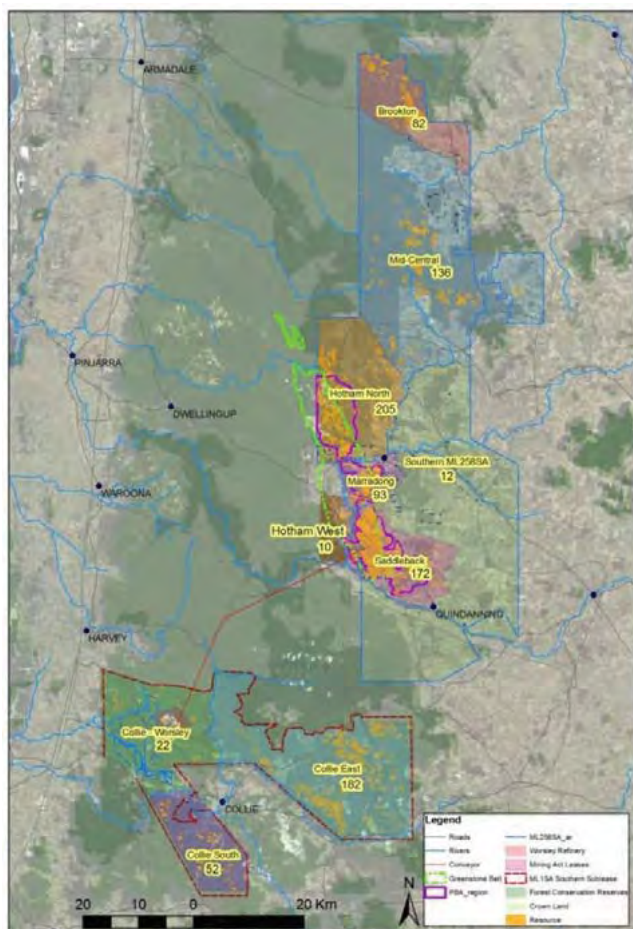

Figure 7-1: Boddington Bauxite Mine tenement areas

Source: BWAPL (2014)

Note: PBA indicated in purple; ML1SA sublease Alcoa in dotted red line

7.2 Mine design and Mining method

7.2.1 Mining method

BBM mines the bauxite by shallow open pit mining methods from a number of open pits. The bauxite occurs in pods, close to the surface, with an ore thickness of up to 5 m.

The typical sequence of mining operations inside the PBA is as follows:

- The State Forest Products Commission removes commercial timber and firewood from the planned mining areas
- Removal of remaining trees and shrubs
- Pre-stripping of topsoil
- Stripping of gravel overburden, typically with scrapers or a backhoe (excavator) and truck combination for thicker overburden areas
- Removal of secondary overburden (where required) by small 30 t backhoe
- Drilling and blasting of the hardcap material or ripping by track dozer. Hardcap is a cemented clastic laterite with a higher proportion of dehydrated minerals, typically with a higher iron content
- Loading of the bauxite by either front end loader (FEL) or backhoe excavators
- Hauling of the bauxite to the primary crushers or to the Run of Mine (ROM) stockpiles by 145 tonne payload capacity trucks
- Backfill mined out areas with gravel overburden from neighbouring pits
- Replace topsoil on top of backfilled mined out areas
- Revegetate the mined out area as part of reclamation.

The bauxite mining is a continuing process of excavation and subsequent rehabilitation of the mined out area. Figure 7-2 displays the sequence of the mining and rehabilitation operations at BBM.

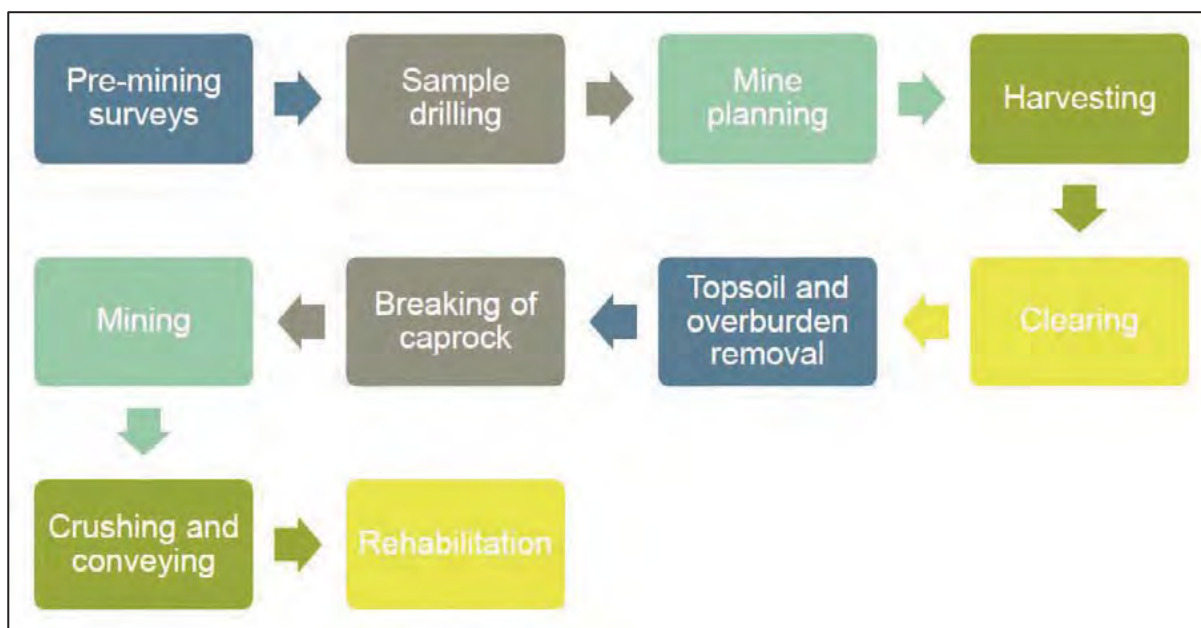

Figure 7-2: Boddington Bauxite Mine – sequence of mining operations

Figure 7-3 to Figure 7-7 show the logical progression from the original forest area to the final reclaimed and reforested area, with all the intermediate mining steps and provide a good overview of typical bauxite mining operations at BBM. This series of photos was taken in the Saddleback area.



Figure 7-3: Edge of original State Forest area adjacent to an active bauxite mining block - Saddleback area



Figure 7-4: Secondary Overburden removal by small backhoe excavators – Saddleback area



Figure 7-5: Loading ore into a 145 tonne haul truck – Saddleback area



Figure 7-6: Backfilled mined out area with topsoil and reclamation area in background – Saddleback area



Figure 7-7: Rehabilitated and reforested area in background – Saddleback area

Typically mining operations will be from 3 to 4 active open pits simultaneously, in order to be able to blend the required Al_2O_3 feed grade for the Worsley Refinery.

The crushed bauxite product, after primary crushing (at Marradong or Saddleback) and secondary crushing at the Saddleback area, is transported to the Worsley Refinery near Collie, via a 2-flight cable belt overland bauxite conveyor (OBC) with a total length of 51 km. The bauxite is stockpiled at the refinery.

7.2.2 Mine design

The majority of the open pits at BBM are shallow to very shallow, typically less than 10 to 15 m deep. Mining of around 18 Mtpa of (wet) bauxite feed to the Alumina refinery requires large areas to be mined on an annual basis, given the limited thickness (between 1 m and 10 m thick) of the bauxite mineralisation. Typically, an area of around 200 ha is mined on an annual basis. A minimum mining thickness of 1 m of bauxite ore is used for Ore Reserve reporting purposes.

7.2.3 Waste dumps

There are very few external waste dumps at the BBM operations. Most of the waste material is deposited back into mined out areas.

Small specific waste dumps are in use for box-cut area where excavations were required for crushing and conveying infrastructure. The Marradong primary crusher box-cut waste material was dumped onto an external waste dump.

7.2.4 Ore stockpiles

Interim stockpiles are used where required for blending purposes close to the active mining operations.

Additional ore stockpiles are available near the Marradong primary crusher (mineral sizer) and at the Saddleback crushing installations. The Marradong crushed ore is transported to the Saddleback crushing areas by a 10 km long conventional conveyor belt.

7.2.5 Mining fleet

The primary mining fleet consist out of backhoe excavators, front end loaders, rigid body haul trucks, wheel dozers and track dozers. Table 7-1 lists the BBM primary mining fleet.

Initial overburden is removed by scrapers and secondary overburden is removed by small 30 t backhoe excavators, when it is impractical for the scrapers to remove the remaining overburden.

Drilling and blasting of the hardcap is performed on special prepared drill track roadways.

After drilling and blasting the bauxite is excavated by larger backhoe excavators and loaded into 145 tonne payload capacity rigid haul trucks (CAT 785 trucks).

Ancillary equipment consisting of scrapers (for overburden removal), water carts (for haulroad dust suppression), graders (for haulroad maintenance) and track dozers (for ripping of hardcap material and general maintenance work around mining areas), supplement the primary mining fleet for the various support services.

Table 7-1: Boddington Bauxite Mine – primary mining fleet

Equipment type	Manufacturer	Manufacturer type	Number
Hydraulic Excavator	Hitachi	EX1800	1
Hydraulic Excavator	Hitachi	EX2500	2
Hydraulic Excavator	Komatsu	PC2000	1
Front End Loader	Caterpillar	CAT 993K	4
Haul trucks	Caterpillar	CAT 785C	15
Wheel dozer	Caterpillar	CAT 844K	2
Track dozer	Caterpillar	CAT D11R	1
Track dozer	Komatsu	475	2
Track dozers	Komatsu	575	1

7.2.6 Mining owner/contractor

The majority of the mining equipment is owned by BBM. Contractors provide additional equipment on an “as required” basis. Development and rehabilitation activities are provided primarily by a contract mining fleet.

7.2.7 Marradong Mining Envelope infrastructure

Marradong has primary and secondary crushing facilities. MMD Mineral Sizers are used for the first and second stage crushing of the bauxite ore. Secondary crushing is done using two SBM impact crushers. A 10 km conventional conveyor system with a 3,500 wet tph capacity delivers the crushed ore from Marradong to a stockpile with a 100,000 t capacity at the Saddleback crushing area. The live capacity of the Marradong stockpile at Saddleback is 20,000 t.

7.2.8 Saddleback Mining Envelope infrastructure

Saddleback has primary and secondary crushing facilities. A Weserhütte jaw crusher is used as the primary crusher at Saddleback. Three SBM impact crushers are used for secondary crushing at Saddleback.

7.2.9 Overland Bauxite Conveyor

The secondary crushed bauxite is stacked onto crushed ore stockpile at Saddleback. From there, the bauxite is delivered to the alumina refinery by the OBC. The OBC is a 2-flight cable conveyor belt with a combined length of 51 km. The first leg of the OBC is 30 km long and the second leg of the OBC has a length of 21 km. The OBC has a conveying capacity of 3,400 wet tph of bauxite.

At the alumina refinery, the OBC discharges the bauxite onto stockpiles, from where the bauxite is reclaimed, when the feedstock is required for the refinery.

7.3 Life of Mine schedule

The BBM LOM production schedule, based on Ore Reserves of 288 Mt of bauxite, covers a period of around 16 years from 1 January 2015.

Table 7-2 details the BBM LOM production schedule. Bauxite tonnages mined and processed and available alumina grades are shown.

Table 7-2: Boddington Bauxite Mine – life of mine bauxite production profile (as per valuation model)

Year	Unit	June 2015	June 2016	June 2017	June 2018	June 2019	June 2020	June 2021	June 2022	June 2034	June 2024	June 2025	June 2026	June 2027	June 2028	June 2029	June 2030	June 2031	
Bauxite to Refinery	Mdt	8.54	17.34	17.15	17.28	17.53	17.51	17.65	17.67	17.67	17.67	17.67	17.67	17.67	17.67	17.67	17.67	17.67	16.46
Bauxite consumption factor	t bauxite/ t alumina	3.68	3.70	3.63	3.63	3.65	3.65	3.68	3.68	3.68	3.68	3.68	3.68	3.68	3.68	3.68	3.68	3.68	3.68
Bauxite Grade	% available alumina (WDIE)	30.9%	30.9%	30.9%	30.9%	30.7%	30.8%	30.5%	30.5%	30.5%	30.5%	30.5%	30.5%	30.5%	30.5%	30.5%	30.5%	30.5%	30.5%
Ore Reserve Remaining	Mdt	280.0	262.6	245.5	228.2	210.7	193.1	175.5	157.8	140.1	122.5	104.8	87.1	69.5	51.8	34.1	16.5	0.0	

7.4 Historical operating performance

The historical mining physicals for the last four financial years (ending 30 June, each year) are listed in Table 7-3. The units are in wet kilotonnes (wkt) and include a moisture component.

Approximately 4 t of bauxite feed are required per tonne of produced alumina, based on the historical performance.

Table 7-3: Boddington Bauxite Mine – historical mining physicals

Activity	Description	Unit	FY11	FY12	FY13	FY14	FY15 (forecast)
Topsoil	movement	wkt	855	486	527	1 254	798
Gravel	movement	wkt	1 354	1 758	1 551	5 947	3 956
Waste	movement	wkt	3 295	3 165	3 130	2 382	3 714
Ore	movement	wkt	10 339	13 895	14 056	18 958	22 818
Drilling	holes	'000's	102	103	78	146	144
Blasting	holes	'000's	115	100	75	137	145
Bauxite Ore Ex-pit	mined	wkt	14 379	12 848	15 445	17 261	18 582
Bauxite Ore Conveyed	conveyed	wkt	14 461	13 585	15 741	17 372	18 289
Bauxite Ore Reclaimed	processed	wkt	13 777	13 926	15 749	17 484	18 271
Calcined Alumina	produced	wkt	3 359	3 393	3 808	4 552	4 609
Tonne bauxite / tonne calcined alumina		t bauxite / t alumina	4.10	4.10	4.14	3.84	3.96
Stripping Ratio (including topsoil, including gravel)	t waste movement /t ore movement (ex-pit)	t waste / t ore	0.53	0.39	0.37	0.51	0.37

7.5 5-year plan – FY2015 - FY2019

Over time, mining operations will move further away from the historical Saddleback crushing facilities hub. For FY2015, it is estimated that 73% of the bauxite produced will be from the Marradong area, to the north of Saddleback. Primary crushing facilities were established at Marradong in 2012. The crushed bauxite is transported from Marradong to Saddleback by conveyor belt.

In the LOMP, mining operations will gradually move further north, to the northern part of the Marradong area, and even further north, up to Hotham North area.

The 5-year plan (5YP) for FY2015 up to and including FY2019 maximises the use of the currently available infrastructure at Saddleback and Marradong, for as long as possible, prior to investing capital expenditure in the development of future large-scale bauxite transport and associated mining infrastructure. Maximising of the current infrastructure will include mining of remnant Ore Reserves.

In general, the bauxite haulage distances will increase over time with a concurrent increase in operating costs, due to the larger haulage. Isolated remnant mining areas will also have higher development costs.

The 5YP will require additional crossings of public roads, building of required infrastructure and increased interaction with the local community.

It is expected that the Marradong area, representing 58 Mt of Ore Reserve, as at end June 2014, will be mined out in FY2020. It is expected that the Hotham River will require to be crossed in FY2020 to access mining areas in the Hotham North areas, referred to as the Hotham North Envelope (HNE).

Table 7-4 lists the 5YP tonnages for FY2015 to FY2019. Annually, an area of around 200 ha will be mined according to the 5YP.

Table 7-5 lists the indicative 5YP unit operating costs for the bauxite mining and transportation.

The 5YP does not require any major capital expenditure, but does require sustaining capital expenditure for additional haulroad preparation, relocation of existing infrastructure and replacement of mining equipment. The estimated capital expenditure for FY2015 is around A\$17.6M.

Table 7-4: BBM 5YP – FY2015 to FY2019 (inclusive) – (Interim 5YP – July 2014)

Year	Ore	Gr	Hc/Bz	AAWDIE	RSWDIE	Area	Granite	Saddleback	Haul dist'	Haul truck Prod'
		Waste	Waste	Mine	Mine					
	(Mdt)	(Mdt)	(Mdt)	(%)	(%)					
FY15	16.9	5.7	3.7	30.7	1.50	196	15%	31%	3.6	446
FY16	17.0	6.3	3.2	30.4	1.50	200	30%	43%	4.7	370
FY17	16.9	5.7	3.7	30.4	1.58	200	23%	42%	4.4	352
FY18	17.0	6.1	3.2	30.4	1.50	200	10%	40%	4.1	370
FY19	17.0	6.6	2.6	30.4	1.50	200	29%	63%	4.4	367
FY20	17.1	7.2	3.1	30.1	1.66	220	29%	77%	5.5	337
FY21	17.0	7.6	3.4	30.1	1.68	220	22%	100%	6.2	283

Notes: Gr – Gravel; Hc/Bz – Hardcap, B Zone

Summary table of mining physicals, including indicated years FY20 and FY21 (Based on Reserve Data).

Table 7-5: BBM Indicative 5YP - unit operating cost

Year	Saddleback contribution	Average cost (A\$/dt)	Saddleback costs (A\$/dt)	Marradong costs (A\$/dt)
FY16	43%	13.3	15.2	11.8
FY17	42%	13.1	14.2	12.3
FY18	40%	13.1	14.8	11.9
FY19	63%	13.6	14.5	12.0
FY20	77%	14.8	15.7	12.0
FY21	100%	15.8	15.8	-

Note: FY15 5YP indicated forecast operating cost for delivered bauxite. These numbers are relative and not budget figures (including indicated years FY20 and FY21).

7.6 Operating expenditure

The historical unit operating costs for FY2013 and FY2014 are listed in Table 7-6. The average mining cost per tonne of bauxite conveyed to the Worsley Refinery was A\$7.95/t bauxite conveyed in 2013 and A\$9.96/t bauxite conveyed in 2014. Approximately 30% to 34% of the operating costs are labour charges.

Table 7-6: Annual unit operating costs for the Boddington Bauxite Mine

Unit Operating Costs	Units	FY13 Actual	FY14 Actual	FY15 Budget
Total	A\$/t conveyed	7.95	9.96	10.39
Labour charges	%	35%	29%	26%

Forecasted average mining cost per tonne of bauxite conveyed for FY2015 is expected to be A\$10.39/t bauxite conveyed, of which 26% is for labour charges.

7.7 Capital expenditure

Mining capital expenditure actuals for FY2012, FY2013 and FY2014 and forecasted mining capital expenditure for FY2015 onwards is listed in Table 7-7.

Table 7-7: BBM – Mining capital expenditure

Units	FY12	FY13	FY14	FY15	FY16	FY17	FY18	FY19	FY20	FY2021 onwards
A\$M	104.9	10.3	4.6	17.6	22.5	25.3	17.4	19.2	6.9	3.0

The mining capital expenditure for FY2012 includes A\$93.4M for the Marradong Mine Envelope development, including the crushing and conveying installations.

7.8 Summary comments

BBM has been mining bauxite at the Boddington area for 30 years. SRK is of the opinion that the BBM operations are well managed and well understood.

SRK is of the opinion that the current required infrastructure and mining fleet are in place to ensure the required feed is provided by BBM to the Worsley Refinery, as specified in the LOMP. As the mining operations move further away from the two existing mining envelopes, additional transport infrastructure and capital expenditure will be required.

Where additional infrastructure is required for future crushing and conveying hubs, closer to the planned mining areas, further to the north near Hotham North, the required capital expenditure has been taken into account in the financial model. The installation of future crushing and conveying hubs would be similar to the Marradong mine development, which was finalised in 2012, so this process is well understood.

SRK confirms agreement with the build-up of unit operating costs and sustaining capital.

8 Worsley Alumina Refinery

Worsley Refinery has been operating since 1984. In the 30 years since operations commenced, the capacity has increased from the original 1 million tonnes per annum (Mtpa) of alumina production to the current nameplate capacity of 4.6 Mtpa through a series of expansions. The most recent expansion in 2012 makes it one of the largest bauxite mining and alumina refinery operations in the world.

8.1 Process description

Bauxite is refined to alumina using the Bayer process. This process relies on the principal that aluminium is an element with a high solubility in alkaline solution, whereas most of the other elements in bauxite ore (except silica) are not. The process uses sodium hydroxide to digest (leach) alumina from the bauxite. The liquor containing dissolved alumina is separated (clarified) from residual solids before being precipitated as hydrated alumina before being calcined at high temperature to drive off chemically bound “waters of hydration” to produce the final alumina product.

As with all alumina refineries, the Bayer process has been modified to suit the specific ore types being processed from the BBM. The process is considered to be conventional and the industry standard. It is well suited to processing the BBM ores. The same process is used at Alcoa’s three neighbouring refineries and there is no technical risk associated with the processing route used. This is further demonstrated by the 30 years of operation since first being commissioned.

There are four major steps in the alumina refining process – digestion, clarification, precipitation and calcination – with a number of other supporting processes associated with each main operating area. The final alumina product is railed to the Port of Bunbury before being shipped to BWAPL’s customers.

A summary description of the main processing steps is provided below.



Figure 8-1: Worsley Alumina Refinery

Source: BHP Billiton

8.1.1 Digestion

Mined bauxite is fed through primary and secondary crushers at the Boddington and Marradong mine sites before it is transferred by overland conveyor to the refinery. The 51 km conveyor from Boddington to the refinery is the longest of its kind in Australia. An additional spur line transfers the Marradong ore to this main overland conveyor at Saddleback.

A bauxite product specification is met by blending through the mining of multiple pits. In summary, grades above minimum available alumina and below maximum reactive silica levels (28.5% and 1.35% respectively) are targeted. Several other secondary impurity components are also controlled such as the oxalate and sulphate levels, as both of these impurities are removed from the circuit to improve liquor yield. The blended bauxite feed is sampled at the refinery and the mining schedule is adjusted as required based on the analysis.

The bauxite is stockpiled at the refinery in four ~200 kt stockpiles ready for processing. Sufficient bauxite is stockpiled to provide approximately two weeks of surge capacity at typical consumption rates – enough to cover any major delay to mining or repairs to the overland conveyors.

The stockpiled bauxite ore is reclaimed by two bucket wheel reclaimers and ground in a two-stage grinding circuit using rod and ball mills. Milling uses caustic liquor to form a bauxite slurry. The slurry is heated with steam and more caustic is added to remove contaminants, specifically the reactive silica (kaolinite) in the ore in desilication tanks. The alumina is then dissolved into the slurry in digestion vessels through a combination of pressure and temperature at around 175°C in a series of digester pressure vessels. Bauxite residue, which is predominantly iron residues, is left as a solid residue in the digestion discharge slurry when it is “flushed” to atmospheric pressure. The liquor now contains dissolved alumina at supersaturated levels and at near boiling point temperatures. Flashed steam is recovered and used to heat the incoming slurry.



Figure 8-2: Bauxite stockpiles at Worsley Alumina Refinery

Source: BHP Billiton

8.1.2 Clarification

The alumina dissolved during digestion is separated from the red mud residue in large settling tanks using a settling agent (flocculant). The residue is washed and residual liquor is recovered through a series of washers. Final washed solids are removed and pumped to the bauxite residue disposal facility at approximately 55-58% solids. The remaining liquor containing the dissolved alumina, termed “green” (or pregnant) liquor is then filtered to remove any residual solids which would contaminate the final product, and sent to precipitation tanks. Lime is added to part of the washed liquor stream under temperature to convert some of the carbonate present back to hydroxide which improves alumina yield. This process is called causticisation.

A simplified process flow diagram for the digestion and clarification is shown in Figure 8-3.

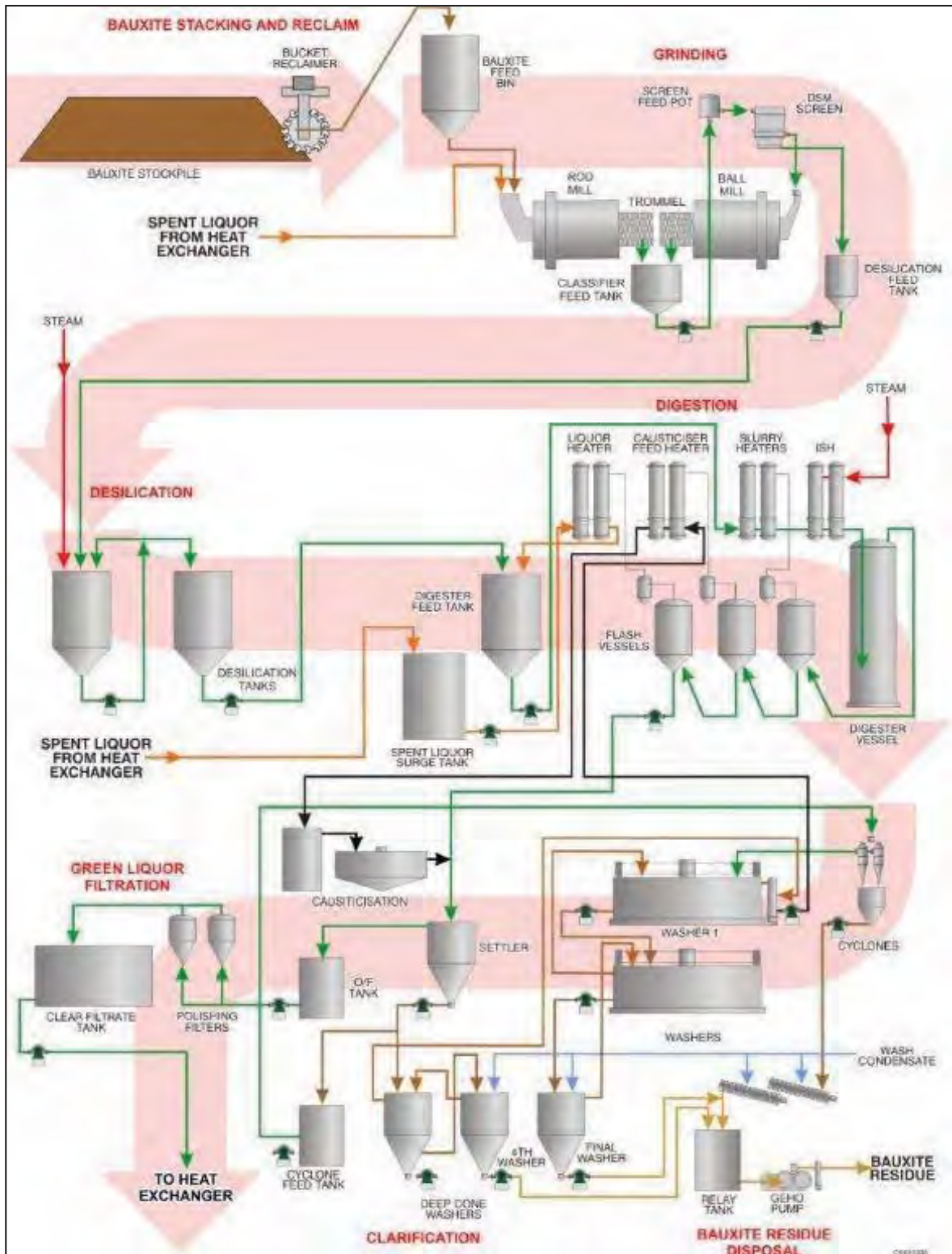

Figure 8-3: Digestion and clarification - summary process flow diagram

Source: BHP Billiton

8.1.3 Precipitation

The alumina-rich supersaturated solution, the “green liquor”, is now clean of the red mud and is at saturated levels. Precipitation is a complex process involving the steps of agglomeration, nucleation and growth. This is a continuous process undertaken through a series of agitated tanks. The conditions of seed charge, particularly surface area, slurry density and temperature are selected

carefully to accommodate these steps. Maintenance of seed stocks is critical.

The hydrated alumina (alumina with chemically bound waters of hydration) slowly precipitates from tank to tank, as the temperature decreases and seed crystals are added to agglomerate fine crystals and then precipitate alumina over the agglomerated seed. There are several other yield drivers used to maximise the alumina “yield” from the liquor (i.e. the difference in the green liquor alumina concentration and the precipitation discharge “barren” liquor alumina concentration). Final precipitation solids are classified (separated on the basis of size). The coarse particles are thickened and pumped to calcination; the finer material is recirculated back to precipitation as seed.

The precipitation area also takes in the oxalate and sulphate impurity removal areas. Oxalate, produced as part of the digestion from a portion of the organic carbon, is a key impurity due to its low solubility in Bayer liquors. It is removed in a side stream of liquor to maximise liquor yield and to ensure it does not co-precipitate with the alumina. At Worsley, the oxalate is removed from the main liquor circuit by co-precipitating it with gibbsite in a controlled way and then washing the gibbsite to dissolve the oxalate. To do this, a solution side-stream is sent to crystallisers, thickeners and filters, producing an oxalate cake that is trucked to landfill within the BRDAs.

Of the filtered oxalate cake produced, 70% can be fed to a liquor burner where the temperature is increased to around 700°C using natural gas at which point the oxalate cake and alumina dust react to convert to a stable sodium aluminate and carbon dioxide. Volatile compounds and particulates are removed through an electrostatic precipitator and passed through a catalyst bed to destroy the volatiles. The remaining 30% is disposed of to a dedicated oxalate residue storage facility. When the liquor burner is not available, all oxalate cake is stored in this facility.

8.1.4 Calcination

Thickened solids from the precipitation circuit is filtered and washed with clean condensate to remove any soluble impurities in the residual liquor. The hydrate is then dried in hot air at 600°C before being passed into a fluidised bed gas furnace (calciner) where it is heated to 900°C – 1000°C to remove chemically bound water in the hydrated alumina crystals. Calcined alumina, often referred to as smelter grade alumina (SGA) is cooled, stored and loaded onto trains for transport to the Port of Bunbury.

A simplified process flow diagram for the precipitation and calcination areas is shown in Figure 8-4.

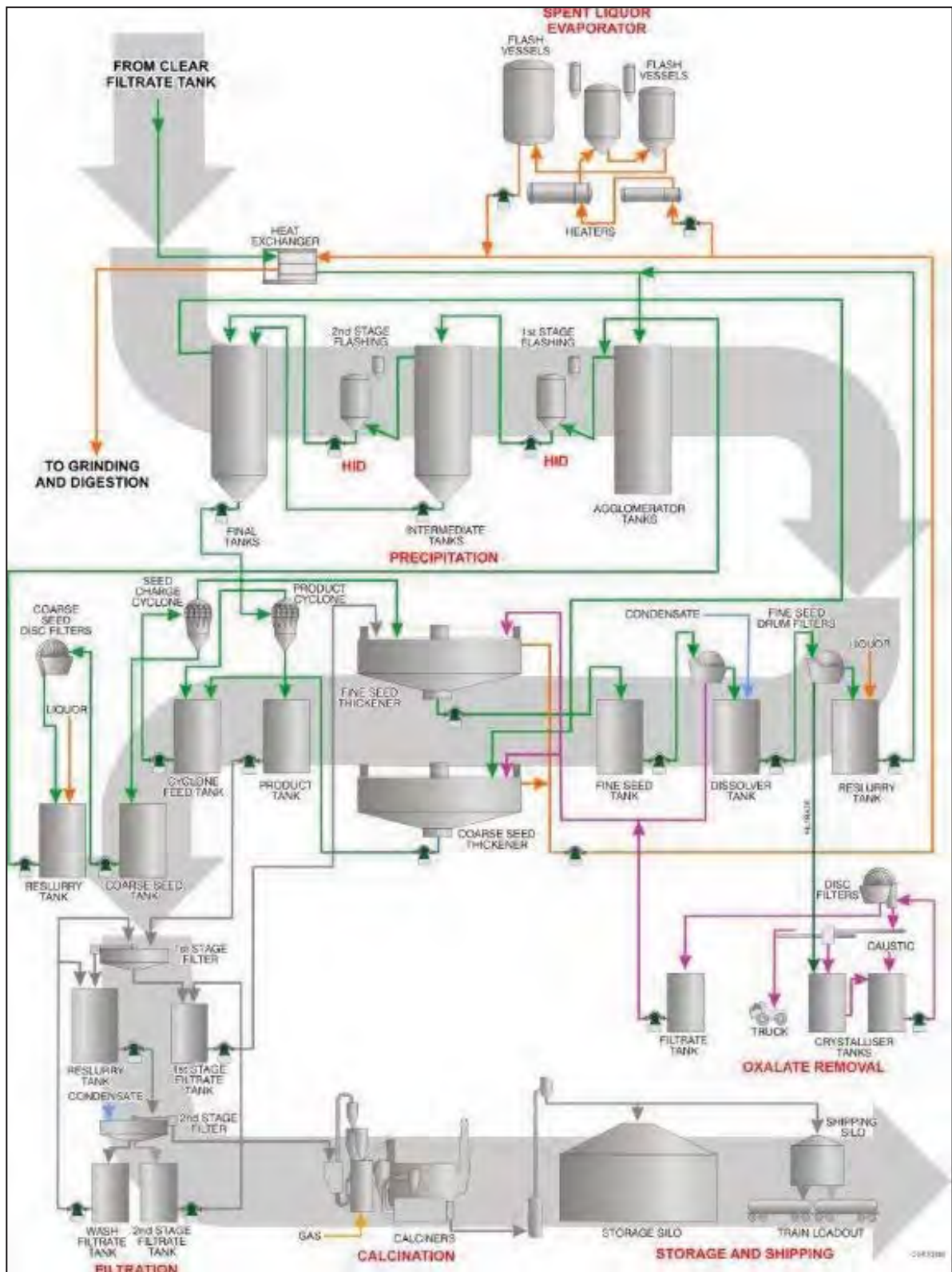

Figure 8-4: Precipitation and calcination - summary process flow diagram

Source: BHP Billiton

8.2 Metallurgical testwork

BBM ore has been processed at the Worsley Alumina Refinery for over 30 years and as a result are comprehensively understood. There is a relatively small amount of variability in the feed blend and the metallurgical processing characteristics are predictable and manageable within the existing refinery. Whilst there is extensive optimisation work undertaken at the refinery, there is no need to undertake metallurgical testwork on these similar ore types. This is typical of the Darling Range alumina refineries and in SRK's opinion is considered to be an appropriate practice.

The bauxite ores currently processed at Worsley are from greenstone ores. A change to a granitic feed is scheduled in approximately 2032. This material is more physically competent than the current feed, has marginally high levels of residue minerals (i.e. higher residue load) and higher levels of impurities such as oxalate, as well as trace elements.

8.3 Product quality

A SGA product is produced at the Alumina refinery with a single product specification. Target product specification is typical of SGA products with an alumina grade of over 99%, Na₂O under 0.5% with the remaining impurities of SiO₂, Fe₂O₃, CaO, ZnO, TiO₂, P₂O₅, V₂O₅ – all at trace levels. Vanadium is notably low compared to some other alumina producers.

The Darling Range bauxite contains relatively low levels of impurities and the product specification is met without exception when measured monthly and by shipload. Contained soda has increased marginally after the 2012 expansion, but remains under target. It is reported that this is primarily associated with sub-optimal alumina seeding control resulting in increased occluded soda. This claim is supported by a small increase in the coarser size fractions over the same period (but still within specification). A project is in place to optimise seeding through modifications to the seed cyclone cut sizes. This is aimed at improving yield, but is also expected to reduce product soda levels to recover caustic and reduce costs.

8.4 Historical production

The Worsley Refinery has been expanded several times, with the most recent "Efficiency & Growth" (E&G) project being a major expansion to increase the plant nameplate capacity to the current 4.6 Mtpa of alumina. This project was completed in mid-2012 and since mid-2013, throughput has been equivalent to ~4.5 Mtpa on an annualised basis. Production for FY2014 was 4.52 Mt of alumina. On a monthly basis this has crept up and there have been several months in excess of an annualised 4.6 Mtpa of production. The general trend is an increase in production.

This expanded nameplate capacity has been achieved but there is potential for further incremental increases in capacity utilising the existing refinery with negligible to low capital costs.

The following production data graphs and explanatory notes are taken from the "Worsley Quarterly Production Report" for the first quarter of the FY2015. They illustrate the ramp-up of alumina production since the E&G expansion commissioned in mid-2012 and demonstrates the plant's capacity to meet forecast throughput. The use of historical operating data to forecast future production is complicated by the fact the operation is still effectively in ramp-up mode. It is expected there will continue to be a further production creep in upcoming quarters through continued improvement and optimisation of the refinery in its current state.

8.4.1 Alumina production

Input production is determined by the amount of "clear flow" multiplied by the "yield" or recovery of alumina from the liquor through the precipitation circuit. Quarterly Input production was 1.140 Mt.

This is the equivalent of 4.525 Mtpa compared to design of 4.6 Mtpa and budget of 4.64 Mtpa. Causes of the lower than budget Input production for the last quarter, rather than an increasing trend included a double digestion outage instead of the planned single digester outage, other digestion trips, high hydrate inventory due to the unplanned calciner outages, a mill gearbox failure and marginally lower bauxite grade. This is considered to be an anomaly in the trend. In SRK's opinion the Input production capacity should meet the current and future LOM production plan with the ongoing throughput and yield creep. Input production is shown in Figure 8-5.

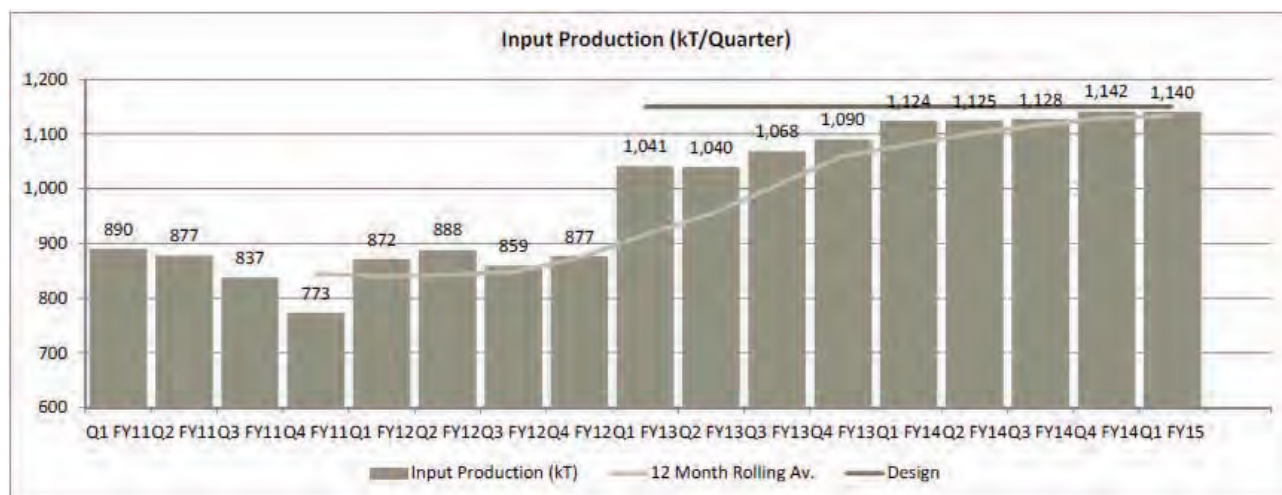

Figure 8-5: Worsley input production

Source: Worsley Quarterly Production Report Q1 FY2015

8.4.2 Available alumina grade

Due to the change in the analytical tests there has been a drop in the available alumina grade (as per the mine plan) in the bauxite feed. This complicates any comparison of numbers pre-and post-2014. The drop is due to a change in the analytical technique used to measure available alumina, from the WDIE method to the WLAA method to better represent plant conditions. By adding some alumina to the test digestion liquor, the alumina loading in the barren liquor stream is better simulated, in turn enables improved estimation of actual leach extraction of alumina from the bauxite. This decreases the measured available alumina, but the input recovery has increased. This also marginally drops the reactive silica analysis.

8.5 Forecast production

The LOMP forecasts annual production of 4.6 Mtpa of alumina in FY2015 with a gradual increase to 4.8 Mtpa by 2019. The FY2015 forecast is the nameplate production capacity of the plant after the most recent E&G expansion. Forecast production is shown in Table 8-1.

Worsley Refinery has a "Production Roadmap" that details the specific projects, incremental yield improvement of each project, implementation schedule, budgets, resources and project leaders, risks and mitigants. This Production Roadmap exceeds the LOM forecast throughput, providing some contingency in the forecast.

Based on historical production, the historical trends of the key production drivers and the expectation of ongoing production creep from the relatively recently commissioned expansion, in SRK's opinion, the forecast production throughput is achievable.

Table 8-1: Forecast production

Total production (MtpaA)	FY2015	FY2016	FY2017	FY2018	FY2019+
		4.64	4.68	4.72	4.76

Source: Worsley Alumina Valuation model

Production for what is considered a “perfect day” under the present plant operating conditions is used as a benchmark for the refinery. It focuses on throughput (7,950 m³/h), utilisation (95%), yield (74.3 g/L), production (13,286 tpd alumina) and cost. These current perfect day conditions produce an annualised production rate of 4.7 Mtpa.

During the last expansion, not all aspects of the plant were debottlenecked. As a result there are new capacity pinch points. Each area has a production limitation but this has not inhibited the plant achieving the current throughput target and will not limit the creep production target by 2019. There is sufficient scope to increase flow and yield to increase the current refineries capacity past the forecast target. It is not considered to be an aggressive target.

8.6 Raw materials

The major raw materials used in the refinery process are bauxite, caustic soda, energy and lime. All are closely monitored in order to manage and minimise their cost; particular emphasis is placed on energy and caustic.

Caustic usage is the measure of the amount of caustic soda used during the process of making one tonne of alumina. It consists of chemical soda loss which is determined by the amount of reactive silica in the bauxite and net physical soda loss which occurs through the washing circuit and the amount of soda in the final product. Average caustic usage during the quarter was 100.8 kilograms per tonne alumina (kg/tA) against a design of 85 kg/tA and budget 98 kg/tA. Chemical soda loss of 68.5 kg/tA was above design of 54 kg/tA due to elevated bauxite reactive silica levels during August and September and a period of only two Deep Cone Washer operation resulting in less efficient washing of residue. Caustic loss is also elevated due to losses to product due to a marginal increase in occluded soda, marginal increase in total organic carbon (TOC) and some other minor losses. Caustic consumption in the FY2014 was below budget and target.

In the longer term LOM, target caustic consumption is being reduced by a drop in reactive silica, improved evaporation efficiency, feedwell design improvements (flocculant dosing points) and an improved flocculant. There are a number of other initiatives in place to reduce this consumption in the long term and it remains a key focus for the plant. In SRK’s opinion, the target and budgeted consumption are both realistic, achievable and can be further improved during the LOM.

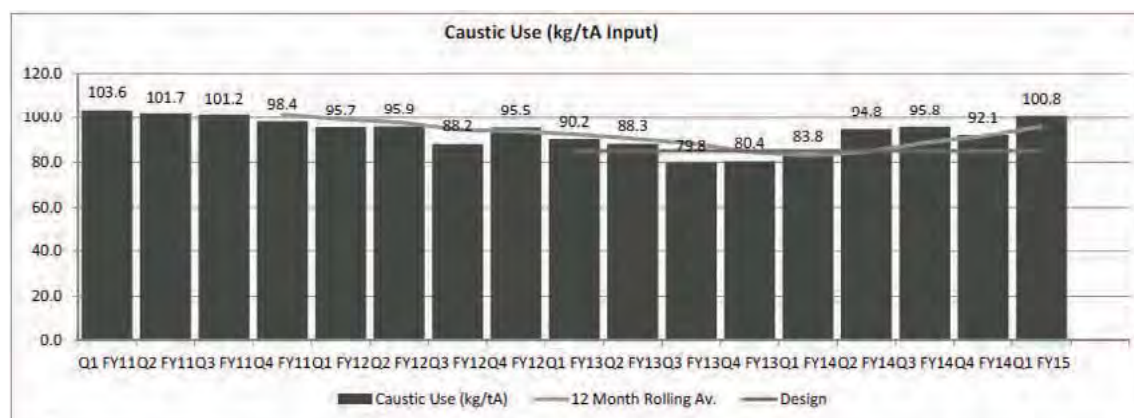

Figure 8-6: Caustic usage

Source: Worsley Quarterly Production Report Q1 FY2015

Energy usage during refining is a key raw material input. Worsley Refinery enjoys one of the lowest energy input costs for any alumina plant in the world. The main contributors are relatively low cost coal from Collie, domestic natural gas from WA's North West Shelf and an efficient refinery.

Since the latest upgrade, energy consumption remains below design, close to budget and should continue to improve with several energy improvement projects underway. Energy supply considerations have historically been around cost, availability and reliability of supply as well as emissions. The position for Worsley Refinery is to continue with coal as the primary source of energy production during the 5-year horizon as it is the most likely and cost-effective option.

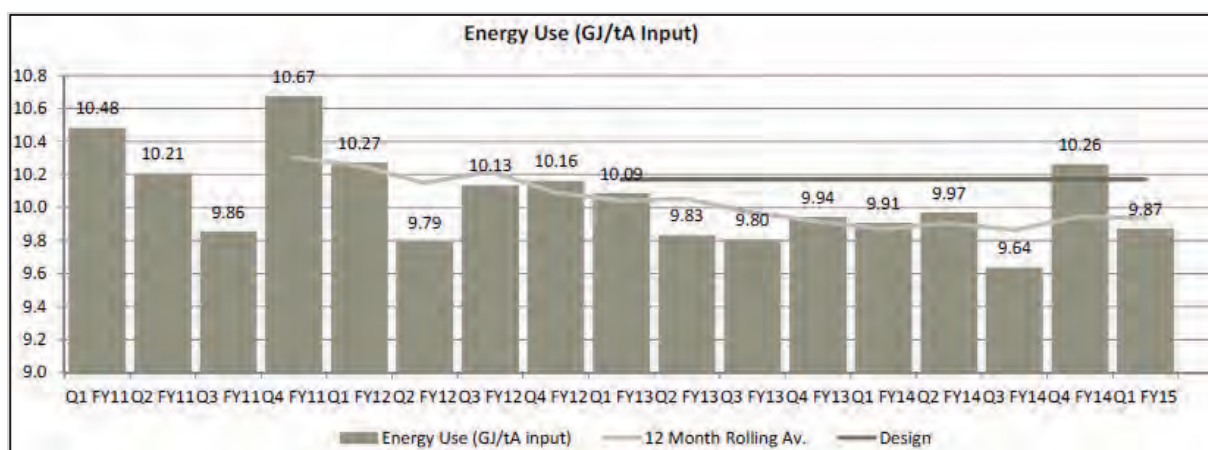

Figure 8-7: Energy usage

Source: Worsley Quarterly Production Report Q1 FY2015

8.7 Operating expenditure

The Worsley Alumina Refinery is a low cost alumina producer. Historical and forecast operating costs from FY2011 to 2019 are shown in Table 8-2. It shows the C1 cash costs remaining steady ranging between A\$215/tA (t Alumina) – A\$220/tA both historically and for the 5YP to decreasing from FY2011 of A\$278/tA to A\$221/tA per year by 2019. The spike in 2012 is considered to be a partial anomaly associated with the E&G expansion resulting in some consumables, maintenance, materials and contractor costs being elevated as part of the project execution, with not all of it assigned to the capital cost of the expansion.

Table 8-2: Historical & forecast cash costs of the Refinery

Refinery Operating Cost	Actual	Actual	Actual	Actual	Plan	Plan	Plan	Plan	Plan
	2011	2012	2013	2014	2015	2016	2017	2018	2019
Refinery Only Operating Cost (A\$M)	662	731	832	987	1,014	1,007	1,029	1,049	1,042
Total Production (MtpaA)	3.37	3.39	4.27	4.55	4.64	4.68	4.72	4.76	4.80
Refinery Only Operating Cost (A\$/tA)	196	216	195	217	219	215	218	220	217

Source: Worsley 2 Year Budget and 5 Year Plan

The 5-year plan has a focus on reducing the overall cost of production even though the refining cost is relatively stable. This is through:

- Increasing production (as per the forecast to leverage fixed costs)
- Reduced waste and removal of non-value adding activity for cost savings
- Labour cost optimisation.

More specifically, forecast operating costs reductions are through the current focus on improved productivity in several areas including maintenance, capital management and operating cost management. The forecast drop in operating costs is a function of several main cost drivers:

- Caustic soda reduction due to a drop in reactive silica which drives around 78% of the caustic consumption (2 kg/t) as well as increased evaporation through the plant, better thickener feedwell flocculant addition points (feedwell design), and a new flocculant
- Labour reduction associated with efficiency improvements
- Improved consumables consumption and lower maintenance costs through improved efficiencies
- Increased production rates driving down unit processing costs as a function of similar fixed costs but an expanding production base
- Raw materials, particularly coal cost is forecast to increase through the purchase of an increasing portion coal from a second supplier to reduce supply risk and increasing gas price.

The confirmed cessation of the SWCJV past 2016, results in an increased reliance on coal as an energy source. The BWAPL marketing group is moving to determine the long-term price assumption for coal sources. Worsley Refinery has been one of the lowest energy cost alumina refineries in the world and relatively low cost coal from Collie has contributed to this position. Ownership changes and the current financial position of Worsley Refinery's major coal supplier remains a risk to the low-cost position.

In SRK's opinion, the forecast costs are supported by historical costs, the reduction of those costs associated with the E&G expansion, the current focus on cost reduction and the enablers budgeted.

8.8 Capital expenditure

The Worsley Alumina Refinery has recently undergone a large expansion to the current capacity. There are no further significant expansions or growth projects planned at this stage. However, there is an extensive resource available that would allow for potential future expansions or a second refinery. These are not factored into the current LOMP.

The next significant development project cost is forecast in 2032 in expectation of granitic ores being fed to the refinery. This is outside the current reserve LOMP and is not considered as part of the valuation (provided for information only). An amount of A\$88M (in current dollar terms) has been assigned to these expansions to allow for the harder ores and marginal increases in reactive silica, residue load and oxalate levels. This allowance also provides for a production increase to 5 Mtpa if not already achieved. Detailed costings are not available given the project is still 18 years from implementation, but estimates are based around any additional; crushing (high pressure grinding rolls), desilication capacity, digestion pumping, impurity removal and mud washing/filtration capacity, heating and precipitation requirements as well as a review of utilities.

The historical capital costs from 2011 to 2014 are shown in Table 8-3.

Table 8-3: Historical & forecast Refinery sustaining & major projects capital costs

Refinery Capex (100% A\$M)	Actual	Actual	Actual	Actual	Plan	Plan	Plan	Plan	Plan
	FY11	FY12	FY13	FY14	FY15	FY16	FY17	FY18	FY19
Total (including Major Projects)	1,234.2	905.4	181.9	137.4	165.3	107.9	134.9	113.4	79.4

Source: Worsley 2 Year Budget and 5 Year Plan

The forecast capital costs for the 5-year LOMP are also shown in Table 8-3. The average cost is A\$103.7M per year, with a peak of A\$134.9M spent in 2017 associated with the expansion of the RCL and oxalate removal studies and projects. These costs for the first five years are based on a detailed engineering capital cost plan, maintenance regime and current equipment condition and life. These sustaining capital costs reflect historical costs and in SRK's opinion are well supported. The minor drop in cost is based on a focus on minimising capital expenditure after the major expansion. The long term sustaining capital cost used for LoM modelling is A\$107M per year (A\$121M per year). This appears to be appropriate given it is in line with the 5-year plan estimated capital costs and there are no correlating production increases or Major Projects planned.

8.9 Costs summary

As a result of the multiple JV partners of the operation and to meet their requirements, Worsley Refinery capital and operating costs are heavily audited, with four audits undertaken annually. Their different compliance requirements ensure a high level of rigour in all aspects of capital and operating cost control. This extends to the budgeting process and approvals for sustaining and major development capital. Although BHP Billiton owns 86% of the operation and manages the day to day operations, the combined JV partners have equal voting rights and the JV partners sign off on the budgets and capital expenditure. This ensures rigid, well controlled and audited cost control.

8.10 Risks and opportunities

Worsley Refinery has a strong focus on risk. Any risks considered material are addressed and mitigated. The following are key processing risks, identified as part of the current 5-year plan:

- Water management – due to climate changes, Worsley faces periods of low rainfall and potential high rainfall events
- Electrical power – total energy supply cost, fuel supply security and emissions
- Oxalate control – long-term sustainable solution required, particularly with introduction of granitic ores scheduled in 20 years' time.

Measures to manage all of these risks are in place. The review concurs with the identified risks, acknowledges that suitable risk mitigants are in place and has not identified any additional major risks to the ongoing operation.

The key opportunity is for ongoing production "creep" using low or no capital cost production increase projects. The refinery is currently operating at or close to nameplate capacity of 4.6 Mtpa, and has capacity to creep to 4.8 Mtpa.

SRK agrees with the identified opportunities and the low capital cost strategy required to realise a continued production increase.

8.11 Summary comments

The Worsley Refinery uses the conventional Bayer process to extract alumina from bauxite ores. SRK considers that the current refinery remains appropriate to execute the LOM processing plan, is well managed, well operated and well maintained, with limited technical risks associated with the ongoing operation.

Minor modifications to the refinery will be required with the introduction of granitic style bauxite ores. These ores are not scheduled for 20 years. An appropriate allowance has been made to cover any debottlenecking costs associated with the introduction of this ore. These ores do not present a technical risk; they are processed by the three nearby Alcoa alumina refineries.

The refinery capacity is capable of meeting the scheduled LOMP. SRK considers the minor production creep of around 4% via the projects identified to be well supported and achievable in the timeframe.

Furthermore, there is scope to increase production above the forecast LOM production rate. This is supported by an existing project pipeline that allows production to creep to 5 Mtpa.

Forecast sustaining capital has been benchmarked against historical costs and is supported with a 5-year capital project list. Sustaining capital from 2020 is an allowance based on historical expenditure. It is considered conservative, given it is higher than actual historical costs.

SRK considers that BWAPL takes a very proactive approach to risk management. Material risks are appropriately identified, mitigants developed and if appropriate, implemented or are planned to be mitigated. Major risks identified are coal supply for power generation, water supply and oxalate management. They are all being adequately addressed with differing cost implications depending upon mitigation strategy.

9 Infrastructure

9.1 Access

The port, refinery and bauxite mine are all readily accessed through the sealed south west regional road network and the port and refinery are connected to the public rail network. Bunbury is serviced by the Bunbury Airport. The integrated operation is also close to Western Australia’s capital city of Perth. The main access to the refinery from Bunbury is via the Coalfields Highway which has been considered as a regional infrastructure priority and the upgrade is funded and ongoing. The road network is well maintained and fit for the current mining and refinery capacity and for any future expansions.



Figure 9-1: Worsley Alumina location

Source: BWAPL (2014)

9.2 Rail

The South West Rail Network is a single track narrow gauge network used for freight and passenger services in the south west of Western Australia.

This rail network is used to transport alumina product to the Port of Bunbury for shipment; and caustic soda (sodium hydroxide), coal and lime is railed back to site to use in the refinery process. The distance from the refinery to port is 55 km using a site specific spur line connecting to a state owned freight railway running from Collie, around 20 km east of the refinery, to Bunbury. The railway is available to multiple users, the other major one being Alcoa for their alumina and caustic transport. There is also a public rail service operating on part of the line.

A rail haulage contract is in place to provide locomotives, and rolling stock is owned by BWAPL. Currently, around four trains per day are operated. Typically, dedicated alumina and caustic trains are run, but mixed cargo trains have also been used at times. Generally, trains are made up of 44 alumina wagons or 10 caustic wagons although this configuration can be changed to mix loads to meet logistical requirements. BWAPL has been assigned the rail passes that they need to move the required alumina and caustic, having relinquished passes that are not currently required.

Rail capacity is not considered to be a material risk to the ongoing BWAPL operation. The operation can currently meet the 4.6 Mtpa production target and has demonstrated capacity on a monthly basis in excess of the long-term production target of 4.8 Mtpa. The rail loading operation is currently at around 70% of capacity and is not considered a bottleneck for the current operation.

There are no envisaged significant risks that future capacity increases on the rail line, or increased usage by other users, will impact on the LOM production rate, given it can already currently be met. Appropriate rail access agreements are in place to secure tenure. The simplest and cheapest option available to increase capacity is to obtain additional rail passes.

9.3 Power and natural gas

Electrical power and natural gas is available and secured in the medium term for the forecast production schedule. There is a management plan in place and mitigants to manage any risks to electrical and power security.

Alumina refineries have complex heat and steam balances, high electrical power requirements and natural gas demand for calcination and liquor burning duties. The electrical power and steam arrangement is elaborate and relies on a number of electrical and steam generator types as a result of the many expansions through the operation's life. These include three older generation pulverised coal boilers (Boilers 1, 2 & 3) which are coming to the end of their design life but are still operable, two package boilers (7 & 8) used for shutdowns and a co-generator gas turbine operated as the South West Cogeneration Joint Venture (SWCJV), which supplies power into the Synergy operated South West Integrated System (SWIS) and steam to the refinery. This JV reaches the end of its contract life in March 2016. BWAPL and SWCJV have decided not to continue with this contract, however optionality will be maintained, should gas become a lower cost.

As part of the latest expansion, two new multi-fuel cogeneration plants (5 & 6) were installed. They operate on coal but can also be operated on diesel and biomass and provide the bulk of the electrical power and steam. Without the SWCJV gas turbine operating, steam will be limited. The existing package boilers are available, but unreliable and have relatively high maintenance requirements. Alternative options are being considered for steam supplies during outages of the primary supplies for maintenance.

The Synergy-operated SWIS is used as a balancing load, but the plant can operate "islanded". Excess power is fed into the grid as required, requested or when available. With this elaborate

series of power supply options, it is expected that the Worsley Refinery will remain a net exporter of power into the SWIS even if production increases to 5 Mtpa of alumina, especially if future production is met by yield increases.

As the domestic gas price continues to increase, the use of Collie coal becomes increasingly the most cost-effective energy source. Historically, coal was supplied solely by Griffin coal on a long term, but aggressively priced, contract. There have been recent financial concerns given the primary coal supplier has been experiencing financial difficulties. The mostly likely case is that there are marginal increases in coal cost over time to ensure the operations remain viable. The most pessimistic case is that the coal supplier becomes bankrupt and the state takes priority supply of coal driving the price of energy and steam up as the mix of energy sources required for the refinery changes.

Around 100,000 t of coal per month are consumed as part of the current power and steam supply mix. BWAPL has moved to protect this power and steam source by improving the coal supply balance. Premier coal now supplies approximately 30% of the coal demand. Furthermore, a large 400,000 t stockpile of coal is located on site that, with maximum gas supply could allow for a year's power supply. There are further power supply options in the form of partial diesel and biomass firing of the multi-fuel co-generators.

In summary, the risk of coal supply is a known risk, is well understood, there are multiple strategies in place to manage the risk and BWAPL is confident that Griffin Coal will stay in business. The Griffin coal tonnages are long term contracts and even if sold, the Collie coal assets are considered stranded energy sources given their relatively low calorific energy value in comparison to typical export grade coal. Appropriate energy supply contracts are in place to secure power, steam and natural gas requirements for the ongoing operation.

9.4 Water

Water supply is secure and planning is in place, with ongoing review of alternative supply options.

9.5 Communications

The BWAPL operations are long established and located in a developed area of Western Australia. As a result, modern communications systems and infrastructure are well embedded and do not pose a risk to the ongoing operation. Communications (voice, data, email, fax) to and from the sites is through a PABX system. The telecommunications services are deregulated in Australia and there are multiple carriers available. Within sites, an internal short-wave radio communications system is used. Local service providers also provide generally good mobile telephone network coverage across most areas of all sites.

9.6 Infrastructure buildings

There is extensive existing infrastructure buildings including administration buildings, operations buildings, fitted workshops, warehouses, heavy and light vehicle workshops, amenities, personnel, mine maintenance. Employees and contractors are based residentially and therefore there are no accommodation facilities on site. Existing infrastructure buildings are adequate to support the ongoing plant operation now and into the future.

9.7 Port

The Port of Bunbury is the major commercial deep water port for Western Australia's South West region. It provides safe anchorage and does not require significant amounts of dredging. Alumina product is shipped out of the Port of Bunbury which is operated by the Bunbury Port Authority

(recently consolidated into the Southern Ports Authority). The port is a multi-user facility and is recognised as the ninth largest port in Australia, handling in excess of 14 Mtpa. The major commodities imported and exported through the port include alumina, mineral sands, woodchips, caustic soda, silica sand and grain.

Overall tonnages moved through the port continue to increase, and the Port Authority has just released its Inner Harbour Structure Plan which it will use to guide development and expansion to 2031 and beyond. The Department of Transport also has a plan to double the capacity of the Port to more than 30 Mtpa with a proposed business case in place including additional dredging to service Panamax ships and the addition of up to five new berths. The transport corridors that service the port have been identified and protected. Road and rail infrastructure along the service corridor for the port is being upgraded and will ensure high quality access now and into the future. However, the adequacy of the transport networks will be the subject of ongoing monitoring to ensure that peak capacity will be maintained.

The Worsley Berth is located on the north side of the inner harbour and is well protected from ocean swells. The berthing and surrounding land is leased from the Bunbury Port Authority, but the actual wharf, shiploader, storage bins, conveyors, train loading, caustic storage and caustic loading and associated buildings, sheds and infrastructure are owned by BWAPL. Some infrastructure, such as the caustic storage tanks and train loading system, is shared with Alcoa. BWAPL makes ongoing cost contributions to the Port of Bunbury infrastructure. Appropriate lease and access agreements are in place to secure the port's tenure.

The key facilities are the berth capable of loading ships from Handymax ships of around 22,000 t up to Supramax and Panamax ships up to around 64,000 t (restricted by the loaded ship's draught), three alumina storage bins cable of storing 45,000 t each, a shiploader with a loading capacity of 2000 tonnes per hour (tph) and three caustic tanks capable of storing up to 100,000 t of caustic soda.

At the port, alumina is unloaded from the trains via a bottom dumping system and pneumatic transfer onto an enclosed conveyor belt system and transported into three storage tanks, each with a capacity of 45,000 t. Alumina is then loaded onto ships using a Cleveland cascade loading chute which minimises dust and noise. These are key environmental considerations of the port operation.

BWAPL alumina is exported to aluminium smelters throughout the world with the majority destined for the Republic of South Africa, the United Arab Emirates, China, Mozambique and New Zealand.



Figure 9-2: Worsley Alumina port facility (right side)

Source: BWAPL (2014)

The Worsley port facility is capable of meeting the forecast LOM ship loading requirements of the current 4.6 Mtpa increasing to 4.8 Mtpa by 2019. Capacity above 4.8 Mtpa has been demonstrated in four separate months since the E&G Expansion and peak monthly shipping was 5.2 Mt on an annualised basis. It is a relatively simple, well maintained facility carrying the appropriate critical spares and operating within its capacity. It has a berth utilisation of around 50% and has a typical loading rate of around 1250 tph, servicing around 10 to 12 ships per month. Therefore, even accounting for weather restricted loading (mainly rain and wind) and tides, the ship loading facility should be capable of loading up to 9 Mtpa of alumina. If shiploading rates exceed the rates in the shipping contracts then there is potential to be paid dispatch. In SRK's opinion, the shiploading capacity and port facilities do not pose a risk to the LOMP production rate.

No major capital costs have been forecast at the port as it does not need to be expanded; however, if there were to be a major expansion above 5 Mtpa, there would need to be an allowance for some port facility upgrades (none required for the actual shiploader), including additional alumina storage capacity (the conveyor configuration and space allows for this), as well as some other minor expansion works.

9.8 Operating expenditure

Operating expenditure is covered in Section 8.7 Operating expenditure.

9.9 Capital expenditure

Capital expenditure is covered in Section 8.8 Capital expenditure.

9.10 Summary comments

The infrastructure associated with the BWAPL including power, water, rail, port, access, communications and site roads, is considered to be long established, extensive, fit for purpose, proven in operation and capable of meeting the current LOM production plan. It currently meets the nameplate capacity of the upgraded refinery and for sustained periods of several months has met the future LOM production forecast. It adequately supports the execution of the current and forecast LOM production.

The Bunbury Port Authority has plans to significantly increase the size of its operation. This is likely to increase dust emission, noise and traffic movements into the port. Although BWAPL impact at the port will remain unchanged over the next five years, the community response to increased port activity will need to be addressed by all port users. This is an external factor considered as a risk to BWAPL. It is being addressed through detailed baseline data collection and through the continued review and update of the Stakeholder Engagement Strategy, including other port users. This requires a continued focus on integrity, transparency and a consistent approach to stakeholder engagement. BWAPL is considered to be well positioned to manage these risks.

Some access to raw materials, specifically fuel sources for electrical power and steam, as well as the long-term reliability of rainwater for water supply have been identified as risks, and suitable mitigants are in place or in progress to address these risks.

The bulk of the infrastructure has demonstrated capability to exceed the maximum capacity of 4.8 Mtpa. This is considered a potential future opportunity if production is expanded further.

10 Tailings Storage Facilities

10.1 Introduction

BWAPL currently operates five bauxite residue disposal areas (BRDAs) at its refinery site that are classed a High B category dam per ANCOLD guidelines (Guideline on Tailings Dams) – BRDA 1, BRDA 2, BRDA 4, BRDA 4X (located in the northern valley area) and BRDA 5 (located in the southern valley area) as shown on Figure 10-1.



Figure 10-1: Plan of BRDAs and dams

Source: BWAPL (2014)

BWAPL currently produces ~4.6 Mtpa of alumina and as a result produces ~2.24 t of bauxite residue for each ton of alumina i.e. ~10.1 Mt bauxite residue is produced annually.

BRDA1 was filled to capacity in 1993, decommissioned and capped in 2009. BRDA 3 merged with BRDA 4 after part of it was used as general landfill. BWAPL also operates several other dams that are essential to the operation of the refinery. These include two seepage collection ponds, solar evaporation ponds, a fresh water lake and a catchment lake upstream of the refinery.

The tailings from the alumina production process is washed and filtered prior to deposition in the BRDAs. This is done to minimise caustic losses to tailings.

10.2 Tailings storage facilities design and construction

The BRDAs are clay lined with a network of drainage pipes above and below the clay liner layer. The drainage pipes above the clay manage the residue seepage water, while those below the clay manage the natural groundwater. The system is designed to maintain separation of water seeping from the bauxite residue and the natural groundwater.

BRDA 1 through 4 have gravity penstock decants while BRDA 5 has a pumped decant. The pumped decant has gravity decants with internal pipes to a central concrete pump shaft, from where it is pumped back for re-use.

The BRDAs have an initial starter embankment and are then raised by the upstream methodology as shown in Figure 10-2. The upstream raises are also constructed with clay.

There is a required design strength of the residue beach that needs to be achieved to facilitate this raising, especially with a decreasing upper surface area associated with upstream raising. To assist in achieving this design strength, BWAPL employs amphirols to assist with water removal from the deposited residue to improve solar drying, consolidation and strength gain. Once sufficient strength has been achieved for safe dozer access, the density of the residue is then further increased by dozer ploughing to promote further drying.

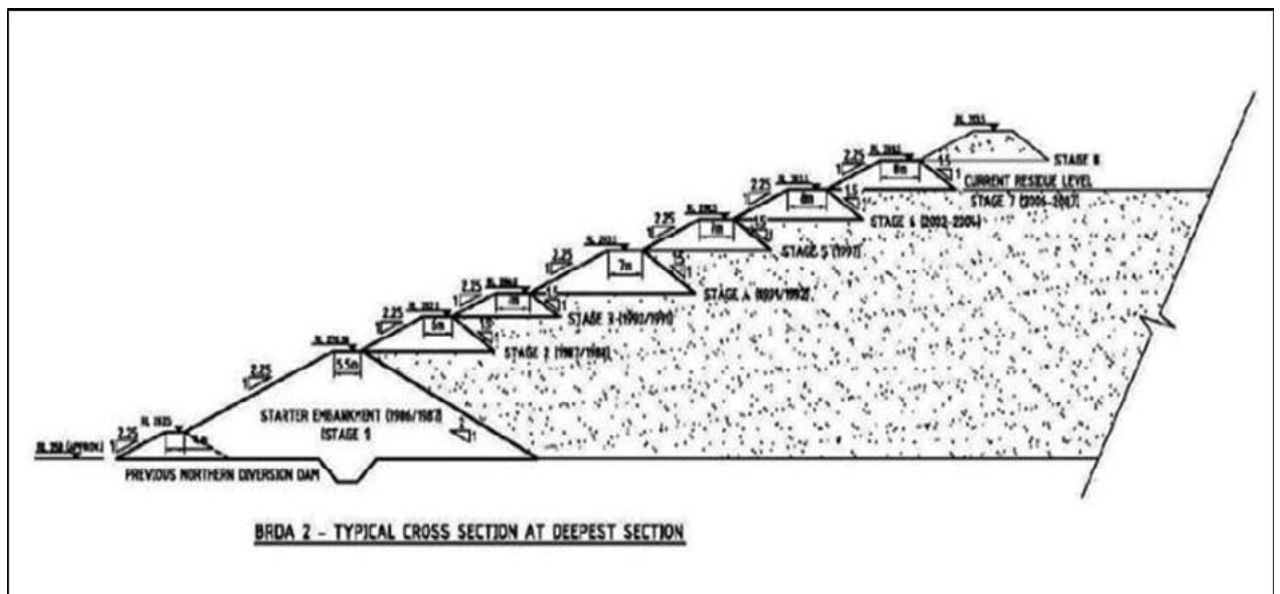

Figure 10-2: Typical embankment cross-section

Source: BWAPL (2014)

The ultimate design heights (RLs) for the various BRDAs have been set at RL 316 based on stability and landform aesthetics criteria. The current BRDA Main Wall RLs and remaining heights are as follows:

- BRDA 2 – 308.5 (7.5 m)
- BRDA 4 – 294.2 (21.8 m)
- BRDA 4X – 294.2 (21.8 m)
- BRDA 5 – 275.7 (40.3 m).

This indicates that there is still capacity in most of the BRDAs with respect to the permitted heights until BRDA 6 is required in 2038.

10.3 Tailings storage facilities construction and operation

The operation of the facility requires the active management of the bauxite residue disposal. The active residue disposal requires enough surface area and cells to ensure a rotation of >42 days between deposition events. Mud farming of bauxite residue using amphirols accelerates residue de-liquoring.

Amphirols are amphibious machines that propel themselves using a screw mechanism that also lifts up or “scrolls” the wet tailings into low banks. Amphirolling normally commences within 72 hours after deposition. The amphirol travels along straight lines down the beach to promote drainage along the swales towards the decant pond. The tailings in the raised banks dries more rapidly than it would if no scrolling occurred, because water drains from the low banks into the shallow swales. Repeated scrolling also lifts underlying wet tailings to the surface and also breaks up surface crusting that reduces evaporation. It also prevents crust formation and subsequent liquor entrapment, whilst maximising the available benefits of natural evaporation and drainage properties.

The active management of the bauxite disposal results in consolidation rates suitable to allow upstream Embankment construction. The areas of new BRDAs developed to meet the raise requirements has to be balanced with areas of BRDAs closed, such that the water management facilities can operate as designed. If too much area is opened and not enough closed, then this could result in unmanageable quantities of contaminated water during periods of high rainfall.

It is currently assumed that the entire bauxite Mineral Resource will be processed at the current Worsley Refinery. The sequence of commencement and closure of future BRDAs has been calculated using the residue deposition rates.

SRK understands that a concept design has been completed for BRDA 6 which will be located on the current refinery lease. SRK further understands that this facility is only required in approximately 2038 with the approvals and detailed planning process starting in around 2033.

The storage capacity of a BRDA 7 with similar capacity to BRDA 6 will possibly be required to accommodate the remaining bauxite Mineral Resource. SRK understands that the location of this facility has not been selected. There is no available space on the current refinery lease and a new site will need to be selected.

Two recent audits and reviews of the BRDAs have been undertaken (in November 2013 and March 2014) by two separate parties. The BRDAs have been designed to a recognised guideline (ANCOLD) and the Western Australian tailings regulatory (DMP) framework is being applied to the design and operation of dams. SRK considers the BRDAs’ design and management to be “leading practice”.

The audits found some discrepancies between operations (reliance on small number of staff and contractors) and operations manuals, and these have been/are being rectified. The facility design also needs to be upgraded to meet the latest ANCOLD (2012) guidelines with respect to liquefaction.

10.4 Oxalate storage

Sodium oxalate is a common contaminant in almost all alumina refineries. Its low solubility in Bayer liquors causes it to interfere with most of the unit processes of the refinery and it must be continuously removed. At Worsley Refinery, the oxalate is removed from the main liquor circuit by co-precipitating it with gibbsite in a controlled way and then washing the gibbsite to dissolve the oxalate. The oxalate solution is sent to a side-stream crystalliser, producing an oxalate cake that is trucked to landfill within the BRDAs.

The current design calls for approximately 80% of the sodium oxalate produced daily to be sent to the liquor burner, but ongoing reliability issues have resulted in the liquor burner only operating at around 70% of the daily input. This impacts oxalate storage in the BRDAs, with current estimates suggesting that existing disposal capacity will be consumed by March 2015.

SRK understands that plans are being implemented to resurrect the disposal capability to a lined pond (SEP3) that will provide four years' storage capacity for all oxalate produced (and significantly longer in reality when the portion sent to the liquor burner is taken into account). Beyond SEP3, SEP 2A is also available if needed and will provide a further minimum of seven years' storage capacity.

10.5 Capital and Operating expenditure

BWAPL budgeted operating and capital costs for the BRDAs for the next five financial years as shown in Table 10-1.

Table 10-1: Budgeted capital

Costs (A\$)	FY15	FY16	FY17	FY18	FY19
Operating Costs - BRDA (\$M)	9	9	10	10	10
Capital Costs - BRDA Construction (\$M)	37	37	38	37	37

The capital costs range from approximately \$3.65/t to \$3.75/t. Based on the upstream raising methodology, this is not unreasonable. This assumes that the operating budget is spent to ensure that the bauxite residue is sufficiently consolidated to support upstream raising.

From Year 5 onwards, i.e. outside the immediate 5-year planning, BWAPL has allowed a budget amount of \$40M for sustaining capital for the BRDAs. These costs may increase when a new BRDA is required in approximately 2038.

The operating costs range from approximately A\$0.90 to A\$1.00/t of tailings. These costs are considered relatively high, and are based on historic actual costs incurred and likely reflect the level of effort required to meet the upstream raising criteria.

10.6 Summary comments

The site has designed tailings capacity through 2038 and has a conceptual plan that may take them to LOM (2070) depending on deposited densities achieved. The BRDAs are built using the upstream methodology, and requires the site to manage cyclic deposition and the tailings beach to be consolidated prior to each raise construction. Consolidation of the beach requires the removal of excess water, which is achieved by using amphirols, followed by ripping and desiccation drying.

BWAPL has planned a desk top study into the best business option for oxalate disposal or destruction for FY2015 in order to set the provide direction for future oxalate disposal treatment in the refinery.

The facility is monitored by the facility designers and audited by two additional external parties on a regular basis. SRK considers the BRDAs design and management to be "leading practice".

11 Human Resources

11.1 Introduction

BWAPL is a major economic driver for the South West and Peel regions of Western Australia. It provides a wide range of professional and trades employment opportunities and has long-term relationships with local contractors, suppliers and service providers. The BWAPL workforce is made up of both direct employees and contractors. The total number of costed employees was over 2,450 as at 30 June 2014, of which around 650 are contractors. Over A\$300M was contributed towards wages and superannuation in FY2014 with additional expenditure on local businesses, State royalties and taxes and community investment. There is currently a companywide efficiency drive to increase productivity and to reduce the number of full time employees and contractors. The most recent initiative has seen around 120 positions become redundant in both operations and administrative support functions. This focus has now moved to reducing contractors and contractor rates.

11.2 Operating structure

BWAPL is a continuous operation, operating on a seven-day week, 24 hours a day basis. The workforce is made up of employees, agency contractors and service contractors. There is an ongoing head count reduction initiative in place. The 5-year plan data (actual and forecast) is provided in Table 11-1. Progress towards the FY2015 plan head count reduction is well advanced with total numbers at end of the first quarter of FY2015 being 2,491 comprising 1,854 employees, 46 agency contractors and 591 service contractors and a reduction to target seems likely.

Table 11-1: Worsley Alumina historical & forecast headcount

Headcount (#)	FY12	FY13	FY14	FY15	FY16	FY17	FY18	FY19
Employees	1,883	1,806	1,941	1,872	1,834	1,834	1,834	1,834
Agency Contractors	84	95	109	31	31	31	31	31
Service Contractors	649	732	553	516	479	479	479	479
Total Headcount	2,616	2,633	2,603	2,419	2,344	2,344	2,344	2,344

Source: Worsley 5 Year Plan

11.3 Recruitment

BWAPL is one of the largest private employers in the South West of Western Australia and is considered to be an employer of choice. BWAPL is considered to be a good corporate citizen with high levels of wider stakeholder engagement and support. The bulk of employees are employed from the regional hub of Bunbury and regional towns proximate to the respective operations such as Collie and Boddington. The mine site is also close enough to the South East Perth suburbs to allow for commuting.

BWAPL has adopted a non-discrimination, equal opportunity and diversification policy. Employment is on the basis of merit. The company employs more than 100 trainees and apprentices and offers a variety of other work programs.

Operations enjoy a very stable and experienced workforce with a long average employee length of service. Overall turnover is between 5% and 7%. This high level of stability is unusual in the resource sector, particularly when compared with fly-in / fly-out operations. It is an important competitive advantage promoted by the good work conditions, remuneration, development and training and lifestyle choice of many to live in the South West. Because of the stability of the

workforce, it is aging and does carry some risks.

There are no issues recruiting and maintaining a highly skilled workforce even during upturns in the resource sector on account of the above.

11.4 Industrial relations

BWAPL is a relatively non-unionised site with over 1840 employees working on a staff contract out of the total of 1,841. Employees work on an individual workplace contracts. They exceed national legal standards and meet local industry benchmarks. Historical industrial relations with the workforce are reputed to be good with no notable unrest in recent history as evidenced by the extremely stable work force and low levels of turnover.

Making up the remaining head count are contractors. There are a number of unionised service and agency contractors on site. BWAPL has adopted an open attitude towards the legitimate activities of trade unions. Worker's representatives are allowed to carry out their legitimate representative functions in the workplace and are not discriminated against. Trade unions are provided with entitled access to the operating sites and have regularly used this access, particularly during award renegotiations where authorised visits have exceeded 200 in a year (2013), but this has not resulted in any significant recruitment of BWAPL employees. Conversely, in comparison, FY2014 saw the lowest volume of union right of entry visitation since the inception of the Act, with 28 visits conducted at BWAPL operations, only four of which were to hold discussions with BWAPL employees. In FY2015, visitation has dropped further and has been focused on service contractors.

In SRK's opinion, BWAPL's exposure to industrial relations risk is considered low, based on the current employee staff contracts, work conditions, recognition/reward, leadership, employee engagement, development, rosters and general employer/employee relationship.

11.5 Summary comments

The human resource characteristics of the BWAPL are not considered a risk to the ongoing operation or the forecast LOMP. BWAPL is a relatively non-unionised employer of choice with a stable, highly skilled regional workforce and a good relationship with employees, contractors and wider stakeholders.

There is an ongoing efficiency drive that will see a reduction in labour costs over the coming years and overall head count will drop. This will need to be managed carefully to ensure the existing relationship with employees is maintained.

Contracting companies provide a number of services and have been an integral component of the Worsley business. Plans to bring more work in-house will impact on the workforce, contractors and contracting companies.

Salary expectations are subject to the relative health of the resource sector in Western Australia and are subject to fluctuations typical of this sector. BWAPL is better protected than most due to the stability of, and existing relations with, the workforce.

BWAPL's exposure to industrial relations risk is considered low.

12 Occupational Health and Safety

12.1 OHS management

Occupational Health and Safety (OHS) falls under the BHP Billiton Global Group level Health Policy. The OHS framework is structured, rigid, managed with expertise, audited and compliant. Over and above this, BWAPL has its own “Health, Safety, Environment and Community (HSEC) Management Standard” that defines the minimum performance requirements and accountabilities for the management of HSEC programs and risks.

BWAPL’s OHS management standards include: commitment and policy; planning; implementation and operation; measurement and evaluation; review and improvement. Performance is well reported and internally audited.

12.2 Occupational health and major exposures

BWAPL is currently focused on a number of key exposures, primarily dust, noise and heat. Furthermore, BWAPL, through BHP Billiton, has a fatal risk control in place to identify, assess and mitigate the major risks associated with:

- Vehicles and mobile equipment
- Explosives and blasting
- Ground controls
- Hazardous materials
- Isolations and permits to work
- Working at height
- Lifting operations.

There are specific policies, strategies, procedures, and the normal hierarchy of safety in place addressing these major exposures but not to the exclusion of all others. There is a continual process of risk assessment undertaken, crisis and emergency management plans in place, security and emergency management.

12.3 OHS performance

BWAPL continues to set the target number of recordable injuries, illnesses and significant events to zero. Their position is that they do not accept or plan for them. The philosophy used to achieve this is to embed the company philosophy to manage HSEC outcomes rather than the outcomes themselves. This strategy is currently being implemented (better design, planned and executed work), with significant improvement in some discreet areas of the business. The expectation is that OHS performance will continue to improve as a result.

Worsley has an elaborate, extensive and well resourced OHS system to ensure the various OHS policies, site guidelines, training, procedures and equipment provide for the best opportunity to meet their zero target.

Historical safety statistics as at the end of September 2014 are summarised in Table 12-1. Injury rates are per million hours worked.

Table 12-1: Historical & forecast summary safety statistics (including E&G Expansion)

	FY12	FY13	FY14	FY15 YTD**
Total Recordable Injury Frequency (TRIF)	5.99	9.45	8.66	9.09
Total Recordable Injuries (TRI)	61	47	43	11
Fatality	0	0	0	1
Total Recordable Illnesses Frequency (TRILF)*	1.57	6.84	5.23	4.96
Total Recordable Illnesses	16	34	26	6
First Aid Cases (FAC)	657	296	284	63
Significant Events	59	42	61	8

* Frequency rate is per million hours

** 2015 Year to date as at 30 September 2014

BWAPL has generally improved performance for TRIF and illnesses; however, a fatality has recently occurred and is under investigation. Significant effort is being placed on OHS to ensure continuous improvement towards BWAPL's stated aims.

12.4 Summary comments

BWAPL adequately addresses the OHS of its employees, contractors and other stakeholders at its operations. There is appropriate formal structure and framework, policy, processes, planning, resourcing, performance standards and reporting, compliance assessment and auditing in place to ensure that BWAPL OHS aims are met, as well as all legal and regulatory requirements.

13 Environmental

13.1 Introduction

This environmental review describes and provides comment on the documented significant environmental aspects and the associated compliance strategies and/or practices in respect to state/national environmental legislative requirements in relation to the BWAPL which comprises:

- Boddington Bauxite Mine (Mine)
- Worsley Alumina Refinery (Refinery)
- Overland Conveyor from the Mine to the Refinery (Overland Conveyor)
- Port of Bunbury Stockpile and Shiploader Facilities (Port Facilities).

13.2 Basis of Environmental Review

The principal environmental documents reviewed were:

- Alumina Refinery (Worsley) Agreement Act 1973 (Agreement Act).
- Worsley Alumina Project Expansion Environmental Review and Management Programme (ERMP), prepared by Strategen in May 2005.
- EP Act Part IV approval for the ERMP – Ministerial Statement 719 (MS719), issued 13 April 2006.
- EPBC Act approval, issued 6 June 2007.
- EP Act Part V – current Works Approvals, Environmental Licences and Native Vegetation Clearing Permits.
- Annual Environmental Reports (AERs) for AER FY2013 and AER FY2014.
- BHP Billiton Worsley Alumina Pty Ltd (BWAPL) response to Environmental Management Liaison Group (EMLG) comments on the Worsley Alumina AER FY2013 (6 January 2014).
- WA Minister of State Development statement on AER compliance (2 December 2013).
- Worsley Technical Audit - Internal Audit Report, 2013.
- MRF Act – 2014 rehabilitation liability submissions and rehabilitation levy payments.
- RIWI Act – current licence to take surface water (Refinery) and associated annual hydrological report.
- Worsley Alumina Refinery Hydrological Monitoring Review, July 2013 – June 2014 (September 2014).
- Current operational environmental monitoring and management plans and reports.
- Conceptual Closure Plan 2014 and closure estimation model and closure plan valuation report.
- Contaminated Sites Assessment Strategy.
- Stakeholder engagement plans, reports and records.

In addition to a desktop review of the above documents, SRK undertook a site visit of the Refinery and the Mine on 22 and 23 October 2014.

13.3 Environmental Setting

The Worsley Alumina Project is located on the Darling Plateau in the south west of Western Australia. The mining operations lie within the Hotham and Williams river catchments, while the Refinery is situated within the Brunswick River and Augustus River Catchments. Existing and proposed mining areas are not located in any proclaimed groundwater areas.

The Worsley Alumina Project lies within three regional development areas that incorporate eight local governments:

- South West Region, which incorporates the Shires of Collie and Harvey and the City of Bunbury
- Peel Region, which incorporates the Shire of Boddington
- Wheatbelt Region, which incorporates the Shires of Brookton, Williams, Wandering and Beverley.

The major project components are located near to the towns of Boddington (Mine), Collie (Refinery) and Bunbury (Port Facilities). The predominant land uses surrounding the general project areas are forestry, mining, power generation and agriculture (Mine and Refinery), and urban/industrial (Port Facilities). The Mine and the Refinery are also situated within and/or surrounded by State Forest areas and privately owned agricultural land.

The project area vegetation lies within the general classification of Eucalyptus woodland, and mainly comprising Jarrah (*Eucalyptus marginata*) and Marri (*Corymbia calophylla*) forest in the west and Wandoo (*Eucalyptus wandoo*) and Marri woodlands in the east. The project ERMP states the Northern Jarrah Forest has moderate species richness and that several species of threatened flora and threatened or vulnerable fauna species have been recorded in existing and proposed mining areas and the Refinery Lease Area. However, no Declared Rare Flora or Threatened Ecological Communities were known to occur in the project areas at the time that the ERMP was prepared.

13.4 Environmental Management

BWAPL has a range of operational environmental management plans which have been developed to address the key environmental issues identified through the project's environmental assessment and approvals (Section 13.5). BWAPL has developed and is currently implementing the following environmental management plans to address these issues:

- Biodiversity and Forest Management Plan (i.e. includes dieback management and site rehabilitation planning)
- Noise Management Plan - Bauxite Transport
- Noise Management Plan - Mining and Blasting
- Water Resource Management Plan – Mining
- Dust Management Plan - Bauxite Mining and Transport
- Refinery Air Quality Management Plan
- Refinery Water Management Plan
- Energy and Greenhouse Gas Management Plan
- Waste Management Plan.

The AER FY2014 states that during the reporting period (i.e. 1 July 2013 to 30 June 2014) an internal audit of the Greenhouse Gas Management Plan, Refinery Air Quality Management Plan, Refinery Water Management Plan and the Noise Management Plan – Mining and Blasting was conducted by BWAPL to assess compliance with MS719 conditions. Generally, the operations were found to be compliant in regards to implementing the requirements of these Management Plans.

BWAPL has a dedicated environmental and community/external affairs department that cover the project's environmental monitoring and auditing and the environmental improvements and approvals. Each of the project's main technical departments has environmental management responsibilities and programs that are specific to their technical areas. For example, the rehabilitation of the mined areas is undertaken through the Mining Department.

13.5 Environmental Issues

The key environmental issues for the project vary according to the nature of the operations being undertaken, as outlined below.

13.5.1 Mine and Overland Conveyor

The key environmental issues associated with the Mine and Overland Conveyor are identified in the documents reviewed as:

- **Land disturbance and rehabilitation:** Mining and rehabilitation are conducted progressively. The AER FY2014 notes that 68.75 ha of mined land were rehabilitated during the reporting period, with 61.58% of topsoil being directly returned from mine pit to rehabilitation area. The AER states that land clearing and rehabilitation practices are generally considered to be satisfactory, but it is noted that there was one incident of clearing outside of the approved boundary during the FY2014 reporting period. This incident was reported to the DER.
- **Noise impacts:** There is potential for noise from the Mine and Overland Conveyor to adversely affect nearby residences and it is noted that 21 noise complaints were lodged by stakeholders during the FY2014 reporting period. The Mine uses a Noise Sentinel system (real time noise monitoring and control system) and attributes the use of this system to a 74% decrease in noise complaints the FY2014 reporting period compared with FY2013. BWAPL implements Noise Management Plans for mining and blasting as well as bauxite transport. The AER FY2014 state that these plans are generally being implemented in a satisfactory manner.
- **Surface water impacts:** The key aspects related to surface water are drainage within progressive mining areas and also general wastewater drainage from ore handling and industrial areas. Mining surface water drainage is collected in sumps and dams, treated then reused for site dust suppression. BWAPL has developed and implements a Water Resource Management Plan – Mining. The AER FY2014 notes that this plan is generally being implemented in a satisfactory manner.
- **Flora and fauna impacts:** There is potential for direct and indirect impacts on flora and fauna due to the operation of the Mine and Overland Conveyor. Of particular concern is the potential for impact on forest areas, and protected conservation areas and the risk of dieback spread. BWAPL has developed and implements a Biodiversity and Forest Management Plan that includes dieback management and site rehabilitation planning. The AER FY2014 notes that the Biodiversity and Forest Management Plan is generally being implemented in a satisfactory manner.
- **Dust impacts:** BWAPL has developed and implements a Dust Management Plan for bauxite mining and transport. Dust management practices are generally considered to be satisfactory, but it is noted that one incident of visible dust emissions was reported to the DER and two stakeholder complaints relating to dust emissions were received by BWAPL during the FY2014 reporting period. The AER FY2014 notes that the Dust Management Plan is generally being implemented in a satisfactory manner.
- **Contaminated sites:** BWAPL has reported known and/or suspected contaminated sites at the Mine (workshop, magazine and landfarm) to the DER in accordance with its obligations under the CS Act.
- **Stakeholder engagement:** Based on the summary information in the AER for FY2014 on community complaints received during the reporting period, the key stakeholder issues associated with the Mine and Overland Conveyor are primarily in response to surrounding ambient residential noise impacts, airblast overpressure and dust emissions. BWAPL also implements a Stakeholder Engagement Management Plan for the Worsley Project on annual

basis. The current FY2015 Stakeholder Engagement Management Plan was provided for review. The Stakeholder Engagement Management Plan addresses the consultation for each key stakeholder group on both operational matters and also project development proposals. In addition, there is also a current Community Engagement Plan that focuses on the consultation with private land owners that will be impacted by future mining plans. BWAPL also maintains a Stakeholder Engagement Register that records the consultation undertaken for the implementation of the engagement plans, as well any public complaints received in respect to project's operations.

13.5.2 Refinery

The following key environmental issues associated with the Refinery are identified in the documents reviewed:

- **Land disturbance and rehabilitation:** BRDAs will require covering and revegetation. The project's Closure Plan identifies a lack of cover material for the BRDAs as a key closure risk, with no proposed remedial actions developed to date. The 2013 Worsley Technical Audit identifies catastrophic failure of BRDA embankments as a key material risk for the project, but considered the risk to be "Well Controlled".
- **Air emissions:** Dust emissions from the BRDAs and dust and sulphur dioxide emissions from processing are the key air quality issues for the Refinery. Environmental monitoring at the Refinery is undertaken in accordance with the site's DER licence number with any stack emission testing results in excess of the licence targets reported to the DER as per the licence conditions. BWAPL has developed and implements a Refinery Air Quality Management Plan. The AER FY2014 notes that this plan is generally being implemented in a satisfactory manner.
- **Surface water impacts:** The key issues associated with surface hydrology identified during this review were water extraction from a fresh water lake, plant/BRDA drainage management and process water management. The 2013 Worsley Technical Audit identifies contaminated water released from site containment as a key material risk for the project, but considered the risk to be "Well Controlled". BWAPL has developed and implements a Refinery Water Management Plan that addresses surface water and groundwater management. The AER FY2014 notes that this plan is generally being implemented in a satisfactory manner. However, the AER FY2014 does note that there was an incident involving a liquor spill into a freshwater catchment area occurred during the FY2014 reporting period (with no environmental impact). This incident was reported to the DER.
- **Groundwater impacts:** The main groundwater contamination risk relates to contamination from BRDA seepage (including from oxalate storage within the BRDAs). The 2013 Worsley Technical Audit identifies insufficient site water inventory to sustain production as a key material risk for the project, but considered the risk to be "Well Controlled". Groundwater management is covered under the Refinery Water Management Plan. The AER FY2014 notes that this plan is generally being implemented in a satisfactory manner.
- **Contaminated sites:** BWAPL has reported known and/or suspected contaminated sites at the Refinery to the DER in accordance with its obligations under the CS Act.

13.5.3 Port facilities

The key environmental issues associated with the Port facilities are identified in the documents reviewed as:

- **Dust emissions:** Dust emissions at the Port occur mainly in association with ship loading. The alumina storage and conveyors are enclosed (including the ship loading conveyor).

Significant dust emissions can occur from the discharge into the ship hold, particularly when the ship hold is close to being filled. Current management strategies include reducing the ship loading rate to reduce emissions and halting ship loading when conditions are windy (i.e. wind monitors are utilised). A closed hatch system is also currently being trialled. Site perimeter ambient dust monitoring is also undertaken and public complaints are recorded. The AER FY2014 states that no public complaints were recorded for the Port during the reporting period.

- **Contaminated sites:** BWAPL has reported known and/or suspected contaminated sites at the Port to the DER in accordance with its obligations under the CS Act.

13.6 Environmental compliance

BWAPL undertakes annual environmental compliance reporting on a financial year basis. This reporting is in accordance with environmental reporting commitments and obligations specified within:

- Worsley Agreement Act
- EPBC Act approval (EPBC 2004/1566)
- EP Act Part IV approval – Worsley Alumina Expansion Project ERMP and MS719
- EP Act Part V licences and permits
- RIWI Act – Hydrological Monitoring Review for surface water licence No.SWL68041(4).

The WA Minister of State Development has stated that “*the EMLG is satisfied that the AER fulfils BWAPL’s requirements under the State Agreement and the Environmental Protection Act 1986*” in relation to the AER for FY2013.

It is understood that the AER FY2014 has been submitted to the EMLG. The AER FY2014 makes the following statements in respect to the project’s current environmental compliance during the reporting period (from 1 July 2013 to 30 June 2014):

- During the reporting period, three environmental incidents were reported to the DER. These were clearing outside of the approved boundary at the Mine, visible dust emissions at the Mine, and a liquor spill into the freshwater catchment area at the Refinery. These incidents were subsequently investigated and corrective measures were actioned.
- An internal audit of the Greenhouse Gas Management Plan, Refinery Air Quality Management Plan, Refinery Water Management Plan and the Noise Management Plan – Mining and Blasting was conducted to assess compliance with MS719 conditions. Generally, the operations were found to be compliant in regards to the requirements of the Management Plans.
- The EPBC Act compliance report was prepared by BWAPL and submitted to the DEH on 16 September 2013. The “Action Implementation Status” for the EPBC Approval (prepared by BWAPL and presented in the AER FY2014), describes the current status as “*satisfactory during this period*”.
- Environmental monitoring at the Refinery was undertaken in accordance with Licence number L4504/1981/16. Stack emission testing results in excess of the Licence targets were reported to the DER as per the licence conditions.
- Twenty eight community complaints were received during the reporting period in relation to mining and conveying activities. Of these, 21 complaints were related to noise, five were related to airblast overpressure and two related to dust emissions.
- Flora and fauna conservation measures have included designation of protected areas, pre-clearance surveys, designation of protected areas and research studies into improvements for rehabilitation.

BWAPL has stated that it expects to receive and respond to the EMLG comments / recommendations on the AER FY2014 during November and December 2014. Note: BWAPL reports that feedback from the Environmental Management Liaison Group (EMLG) confirms there are no outstanding issues.

BWAPL has developed a Contaminated Sites Reporting Strategy to meet its obligation to report known and/or suspected contaminated sites to the DER in accordance with the CS Act. In 2007, BWAPL completed a Preliminary Site Investigation and fulfilled its obligation to report its known and/or suspected contaminated sites to the DER. The reported sites comprises the Refinery, the Port facilities, sites within the Mine (workshop, magazine and, landfarm) and sites on JV properties (e.g. agricultural land with private landfills, cattle yards etc.). In 2010, BWAPL developed a Contaminated Site Assessment (CSA) strategy for the project (Section 14.11). This CSA strategy has been incorporated into the project's Closure Plan (Section 14.7).

BWAPL has stated that no recent external third party environmental audits of the project have been undertaken. The outcomes of the 2013 Worsley Technical Audit (an internal audit) are outlined in Section 13.5.

During the SRK site visit conducted in October 2014, it was considered that the BWAPL site environmental practices and facilities observed at the Refinery and the Mine were generally in line with:

- Site environmental management measures specified in the project environmental documentation reviewed.
- Australian Federal and WA State environmental legislative requirements and guidelines.
- Recognised international industry environmental standards.

13.7 Closure Plan

The current 2014 (Final Draft) BWAPL Conceptual Closure Plan (Closure Plan) is being produced to satisfy the internal requirements of the BHP Billiton Group. There are no conditions within the Agreement Act or M70/258SA that require the submission of a Mine Closure Plan prepared in accordance with the 2011 DMP and Environmental Protection Authority (EPA) Guidelines for Preparing Mine Closure Plans. However, BWAPL used these DMP/EPA Guidelines for reference and guidance in the preparation of the Closure Plan.

It should be noted that the tenement conditions for mining leases subleased by the Boddington Gold Mine require the submission of a Mine Closure Plan to the DMP, but BWAPL has advised that these pertain only to the Boddington Gold Mine.

The 2014 final draft Conceptual Closure Plan states that BWAPL conducted an initial review of legislative and technical site closure obligations and commitments in 2001 and then updated this in 2005 and 2012. These site closure obligations and commitments have been incorporated into the Closure Plan (including establishing technical completion criteria).

The Closure Plan states that under the Agreement Act, BWAPL has "*Bauxite Mining Mine Rehabilitation Agreed Arrangements*" between BWAPL and Department of Parks and Wildlife (DPaW) for State Forest areas. This agreement provides a general rehabilitation prescription and associated criteria, which are incorporated into location-specific mining rehabilitation proposals. In addition, BWAPL is also required, when operations are situated on private land, to enter into a Consent, Compensation and Restoration (CCR) Agreement with the owner prior to conducting bauxite mining or related operations. These CCR agreements specify the purpose for which the land use will be used at completion of restoration (i.e. generally based on pre-existing land-use), and the types and quantities of vegetation that will be planted on the owner's land. SRK notes that Closure

Plan provides an example of a CCR Agreement, but does not provide details and/or copies of the actual CCR Agreements.

The Closure Plan identifies current key closure risks and the associated proposed remedial actions for the project components (Mine and Overland Conveyor, Refinery and Port), and utilises the CSA strategy for the identification of potential closure liabilities associated with site contamination (Section 13.11). While the Closure Plan addresses unplanned closure, the risk of unplanned closure (i.e. within the next five years) is defined as “unlikely”.

Closure cost estimates have been developed for all of the proposed closure risk mitigation controls, strategies and actions (Section 13.8).

The Closure Plan describes the project’s proposed post closure maintenance and monitoring program and states that post-closure monitoring for the Mine and Overland Conveyor will need to continue for a period of 20-30 years; and for the Refinery for a period of 40-50 years.

13.8 Closure Cost estimate

BWAPL developed a conceptual closure plan based on a risk based methodology which considers risks related to closure, controls to eliminate / reduce these risks and residual risks. The closure cost model prepared is Excel based with deterministic and probabilistic components and based on the current project definition is classified as a Class 4 estimate, defined as (-25% to +35%).

The scope of the closure cost estimate is determined according to the cost to control risk and includes a contingency to cover residual risks. Current closure costs do not include HR costs (redundancies), sale and salvage of plant and infrastructure and sale of land or other assets.

As part of BHP Billiton reporting requirements the closure cost model is reviewed bi-annually and updated according to published price indices (Australian Bureau of Statistics). During 2012, the closure cost estimate was updated to include E&G expansion, demolition, and removal of port facilities and revised rehabilitation costs. The total closure cost as at June 2012 was estimated to be A\$2,378M.

In 2014, the Closure Plan was revised and the cost model updated as part of the biannual update. The current closure cost (June 2014) has an undiscounted closure cost of A\$2,094M (100%) with the accounting provision estimated at US\$218M (Table 13-1).

Table 13-1: Summary of 2014 closure cost estimate (Draft conceptual closure plan, 2014)

Last closure review performed	2014 (report)
Next scheduled review	Annual
Current cost of estimate	Class 4
Planned Closure date	2079 (Reserves & Resources)
Relinquished Date	Undetermined
Currency Exposure	100%
Undiscounted Closure Costs (4 June 2014) 100%	A\$2,094M
Accounting Provision (4 June 2014)	US\$218M (100% BHPB)
Likelihood of unplanned closure	Unlikely

Notwithstanding the stated scope, the cost estimate is based on a risk based methodology developed by URS. Whilst this approach provides a Class 4 closure cost estimate which is adequate for this stage of the project, SRK considers that to develop a Class 3 estimate (10 years before closure), further work will be required. This work would be the development of a site specific closure plan with specific completion criteria that can be used for a more definitive Class 3 cost estimate.

13.9 Operating expenditure

BWAPL has stated that operating expenditure for the environmental and community/external affairs department comprises BWAPL staff and technical consultant/contractor costs, and essentially covers environmental studies, monitoring and reporting costs.

BWAPL has also stated that the costs of implementing the project environmental management plans are incorporated into the relevant technical department operating expenditure budgets. For example, costs for the Mine rehabilitation program are within the mining budget and the costs for the BRDA rehabilitation program are within the Refinery processing operating budget.

13.10 Capital expenditure

BWAPL has stated that there is no specific environmental capital expenditure. However, there are environmental related capital expenditure items that are within relevant technical department capital expenditure budgets. For example, capital costs associated the BRDAs and air emission controls are within the Refinery processing capital budget. These technical department capital budgets and expenditure are discussed in detail within the relevant sections of this report.

13.11 Environmental liabilities

The CSA strategy developed for the project by BWAPL has identified the potential groundwater and surface water contamination (and the associated soil contamination) from waste and water storage and management facilities as being the key priority site contamination risk. The proposed overall management approach is:

- Management of contamination sources (e.g. surface drainage systems, spill containment etc.)
- Assessment, monitoring and modelling of groundwater
- Sufficient soil assessments to characterise the extent of contamination.

The CSA strategy is also incorporated into the Closure Plan, such that site contamination risk issues are identified and managed up to decommissioning and closure (i.e. with the objective to rehabilitate the contaminated sites upon closure). The Closure Plan states that the *“full extent of site contamination cannot be determined for most of the Worsley Alumina Project until the final removal of infrastructure such as pads and associated structure in the Mine and Bayer plant area”*. However, monitoring and assessment through the life of the project will assist in gaining an understanding of potential site contamination.

The Closure Plan states that BWAPL will, as a 2014 closure planning action item, *“create a formal contaminated sites register and process for including newly identified sites”*. This will be based on the details reported in the CSA.

There are no conditions within the Agreement Act or M70/258SA that require the submission of a Mine Closure Plan prepared in accordance with the 2011 DMP and EPA Guidelines for Preparing Mine Closure Plans. However, BWAPL has used these DMP/EPA Guidelines for reference and guidance in the preparation of the Closure Plan. The Closure Plan states that the current 2014 estimated closure cost liability is A\$2,094M, and also that there is a significant requirement for post-closure monitoring (i.e. 20-30 years for the Mine and Overland Conveyor and 40-50 years for the Refinery).

13.12 Summary comments

The key environmental issues, risks and liabilities for the Worsley Alumina Project are commensurate with the size and complexity of the project. The location of the project within and adjacent to State forest areas, surface water catchment areas and privately owned agricultural land, has resulted in significant site-specific environmental issues, risks and liabilities. SRK confirms that the project's environmental management has been tailored to address these site specific environmental issues, risks and liabilities (i.e. through the production and implementation of appropriate environmental management plans).

The key closure risks and the associated proposed remedial actions have been identified within the project Closure Plan, including the requirement for post-closure monitoring for the Mine and Overland Conveyor for 20-30 years, and for the Refinery for 40-50 years. The current 2014 estimated closure cost liability is A\$2,094M.

Based on the documentation reviewed and observations made during the site visit, it is SRK's opinion that the environmental management of the Worsley Alumina Project is currently generally in line with Australian Federal and WA State environmental legislative requirements and guidelines, and also with recognised international industry environmental standards (such as the World Bank/International Finance Corporation Environmental and Social Performance Standards and Guidelines).

14 Valuation – Methodology

14.1 Introduction

SRK has undertaken an economic analysis and valuation of the Worsley Alumina Project. SRK has adopted the discounted cash flow (DCF) valuation method to determine the Project's net present value (NPV), and subsequently, a range of values for this project.

14.2 Reporting standard

This section of the Report has been prepared to the standard of, and is considered by SRK to be a Valuation Report under the guidelines of the VALMIN Code.

The VALMIN Code is the code adopted by The Australasian Institute of Mining and Metallurgy (AusIMM) and the standard is binding upon all AusIMM members. The VALMIN Code incorporates the JORC Code for the reporting of Mineral Resources and Ore Reserves.

The effective date of this Technical Value of Ore Reserves is deemed to be 31 December 2014.

SRK has valued the Project on the basis of Technical Value of the Ore Reserve. The "Technical Value" is defined in the VALMIN Code (2005) as shown below:

Clause D36 of the VALMIN (2005) Code: *Technical Value is an assessment of a Mineral or Petroleum Asset's future net economic benefit at the Valuation Date under a set of assumptions deemed most appropriate by an Expert or Specialist, excluding any premium or discount to account for such factors as market or strategic considerations.*

14.3 Valuation method

Most mineral assets can be classified as either:

- **Exploration Property:** properties where mineralisation may or may not have been identified, but where a Mineral Resource has not been identified;
- **Advanced Exploration Property:** properties where considerable exploration has been undertaken and specific targets have been identified that warrant further detailed evaluation, usually by drill testing, trenching or some other form of detailed geological sampling. A Mineral Resource estimate may or may not have been made, but sufficient work will have been undertaken on at least one prospect to provide both a good understanding of the type of mineralisation present and encouragement that further work will elevate one or more of the prospects to the resource category;
- **Pre-Development Property:** properties where Mineral Resources have been identified and their extent estimated (possibly incompletely) but where a decision to proceed with development has not been made. Properties at the early assessment stage, properties for which a decision has been made not to proceed with development, properties on care and maintenance and properties held on retention titles are included in this category if Mineral Resources have been identified, even if no further Valuation, Technical Assessment, delineation or advanced exploration is being undertaken;
- **Development Property:** properties for which a decision has been made to proceed with construction and/or production, but which are not yet commissioned or are not yet operating at design levels; and
- **Operating Mines:** mineral properties, particularly mines and processing plants that have been commissioned and are in production.

SRK considers the property development status to be that of an Operating Mine level. Accordingly SRK has decided on the Income Based Approach and specifically, the DCF methodology, as the valuation method. The project has declared Reserves, therefore, SRK believes that DCF is the appropriate methodology with which to undertake the valuation, as DCF takes into account the information unique to the deposit.

14.4 Materiality

Consideration of materiality as defined within the Valmin Code 2005 refers to: (a) the contents and conclusions of the Valuation; (b) any contributing assessment, calculation or the like; and (c) data and information; are of such importance that their inclusion or omission from a technical assessment or valuation may result in a reader of the Valuation reaching a different conclusion than would otherwise be the case.

The determination of what is material depends on both qualitative and quantitative factors. Something may be material in the qualitative sense because of its very nature, such as, for example, country risk. In the case of quantitative issues in this Valuation, the materiality of data has been assessed in terms of the extent to which the omission or inclusion of an item could lead to changes in total value of: less than five per cent where the item is generally not material; between five and ten per cent where the item may be material; and more than ten percent where the item is definitely material.

15 Valuation - Value

15.1 Commodity Prices & Macro Economics

15.1.1 Introduction

The following section includes historical and forecast statistics to support the principal assumptions regarding commodity prices and macro-economic inputs into the Technical Value of the Ore Reserve for BWAPL. The information as presented has been sourced from various public domain information databases including internet sources.

The following section is presented for information only and should not be considered a substitute for a detailed historical and forecast demand-supply-price analysis in respect of commodity prices and economic analysis nor that analysis typically required to support forecast assumptions with respect to exchange rates and consumer price inflation.

15.1.2 Commodity price

The Company has not specifically commissioned an independent commodity market specialist to provide a detailed demand-supply-price analysis for Alumina. Accordingly, SRK has relied upon consensus market forecasts (CMF) for the short term (less than five years) annual and LTP projections. These are derived from the median of brokers' equity research forecasts and are reported in real terms as at 15 October 2014.

The CMF databases accessed by SRK provide price forecasts for the next three calendar years and a LTP for all periods beyond Year 5. In this instance and where appropriate, SRK has made adjustments to the CMF, specifically when extrapolating the 3-year forecast to the LTP.

Table 15-1 shows the consensus market forecasts used in this valuation. Figure 15-1 shows the range of current consensus forecasts.

Table 15-1: Consensus market forecasts

Commodity	Units	2015	2016	2017	2018	2019	LTP
Aluminium	US\$/t	2,000	2,050	2,050	2,000	2,050	2,150
	USc/lb	91	93	93	91	93	98
Alumina	US\$/t	340	335	330	340	335	350

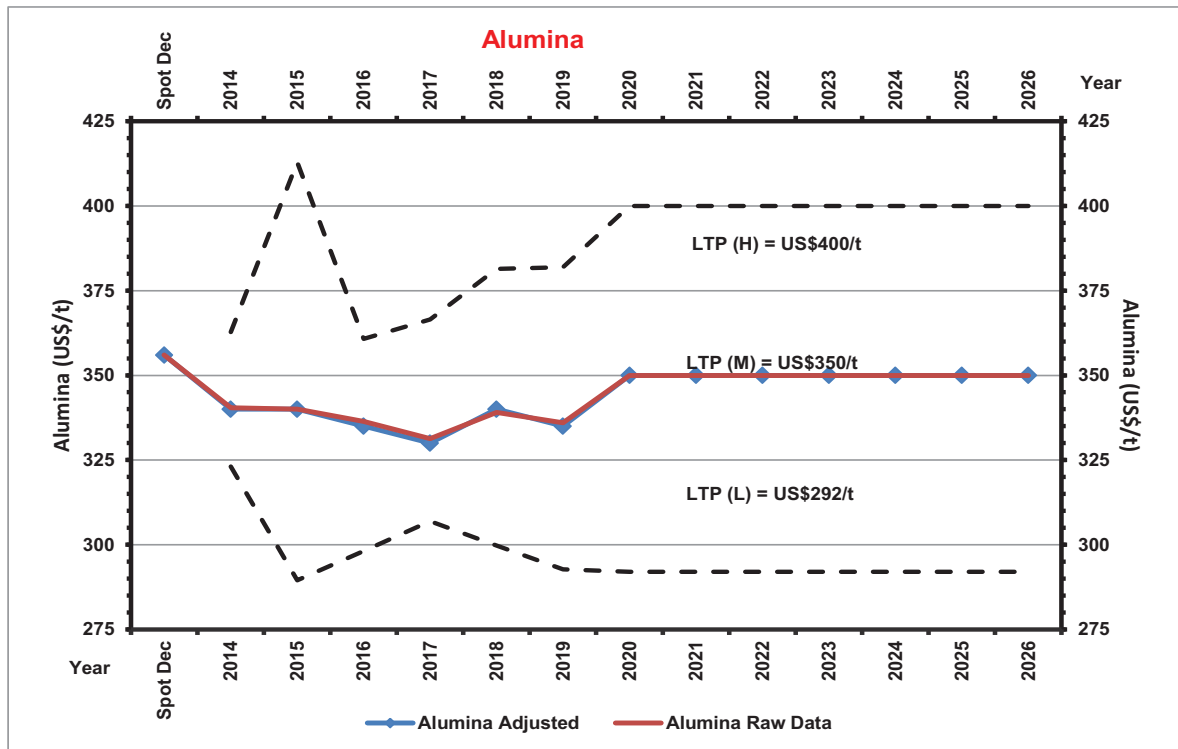

Figure 15-1: Consensus Alumina price forecast

15.2 Macro-economics

15.2.1 Recent and current market conditions

After the downturn of the global financial crisis (GFC), alumina prices and production increased markedly in 2010. Some idled operations were restarted, and major refinery and smelter expansions began planning and construction in Brazil, Australia, and Canada. New pricing indices for alumina began trials, aiming to de-couple the price of alumina from the price of primary aluminium metal, and to better reflect the specific costs of the alumina industry.

In 2011, alumina prices and production continued to increase early in the year; however, began to decline towards 2012. Different factors influenced each of the major global producers, but commonalities negatively influencing the price of alumina included the Fukushima nuclear incident in Japan, developing conflict in the Middle East and North Africa, and the continuing weakness of the US dollar (and particularly the high Australian dollar, relative to the US\$) impacting margins and increasing production costs. Heavy rains in Queensland also impacted alumina production; however, the disruption to production was partially offset by the commissioning of the Rio Tinto Yarwun refinery expansion.

Difficult conditions persisted into 2012, with significant decrease in alumina prices. Despite the price decreases, production increases have continued into 2013 and 2014, attributable to the completion of large expansions by major producers, such as the Alumar refinery in Brazil (BHP and Alcoa), Rio Tinto's Yarwun refinery, and BHP's integrated bauxite mine and refinery at Worsley, Western Australia. Independent alumina producers are also increasing capacity, particularly in China and India. A supply surplus has continued up to early 2014, although prices and profits have decreased due to unfavourable foreign exchange rates, and some supply disruptions in Australia due to cyclone Oswald in 2013.

Sales of alumina using new pricing indices are becoming more widespread. From 2013 onwards, major producers such as Alumina Ltd aim to sell the majority of their production using the new spot

pricing method, de-linking the price of alumina from that of LME aluminium. Although the new pricing methods are expected to improve alumina prices relative to production costs, overall alumina prices have remained low, and high production costs have impacted producers outside China.

In 2014, major operations have been subject to significant write-downs, including BHP's Worsley in Western Australia, or partially suspended operations, as at the Alumar Refinery in Brazil. Other major producers have closed or divested higher cost alumina operations, such as Rio Tinto's Gove Refinery in Australia, and others in Europe and elsewhere. This may cause a supply deficit to occur after late 2014 or early 2015, which could last for several years.

Despite the decreasing profitability of major producers with integrated mining-refinery-smelting operations, commissioning of independent refineries and smelters is increasing, particularly in China. Major producers have indicated that they expect further de-coupling of the bauxite-alumina-aluminium supply chain, and typically show reluctance to commit to any significant additional investment into alumina production in the near term.

15.2.2 Supply issues

Indonesia was the largest exporter of bauxite to China, prior to implementing the ban on exports of unprocessed ore in January. The loss of bauxite from Indonesia, combined with the reduced alumina production or closures of high cost refineries globally, is expected to cause an alumina supply deficit from late 2014. Rio Tinto has already reported that the alumina market outside China is now in deficit.

Refineries which are currently suspended, or operating at reduced capacity, such as Alumar, should be able to respond rapidly to increases in alumina price, and could be returned to full capacity. However, integrated mining-refining-smelting operators such as Alumina Ltd and Rio Tinto have indicated that current operations are focused on bauxite production, with expected reductions in alumina refinery production.

15.2.3 Demand issues

Demand for alumina is driven by demand for primary aluminium, which in turn is linked to growth in the construction and transport industries, especially in China. Divestment and closure of major smelting operations has decreased demand for alumina in the European Union (EU), and power supply issues at smelters in South Africa have limited aluminium production capacity, restricting the demand.

London Metal Exchange (LME) warehouse stock levels of aluminium have significantly decreased during 2014, suggesting that the demand for alumina will increase in 2015. The switch to spot pricing or index based pricing of alumina will decrease the sensitivity of alumina prices to LME aluminium demand, but most alumina producers report that spot pricing has had a positive, upward impact on prices.

15.2.4 Supply/ demand balance effect on price

Although the alumina market outside China is now in deficit, the upward impact on alumina prices may not be significant in 2015. As stockpiles of bauxite from Indonesia are depleted, a deficit of alumina in China may occur in 2015, unless the Indonesian export ban is relaxed. Alumina prices remain low, and most major producers, including BHP, Rio Tinto, and Alumina Ltd have indicated that current conditions do not warrant additional investment in production capacity outside of China.

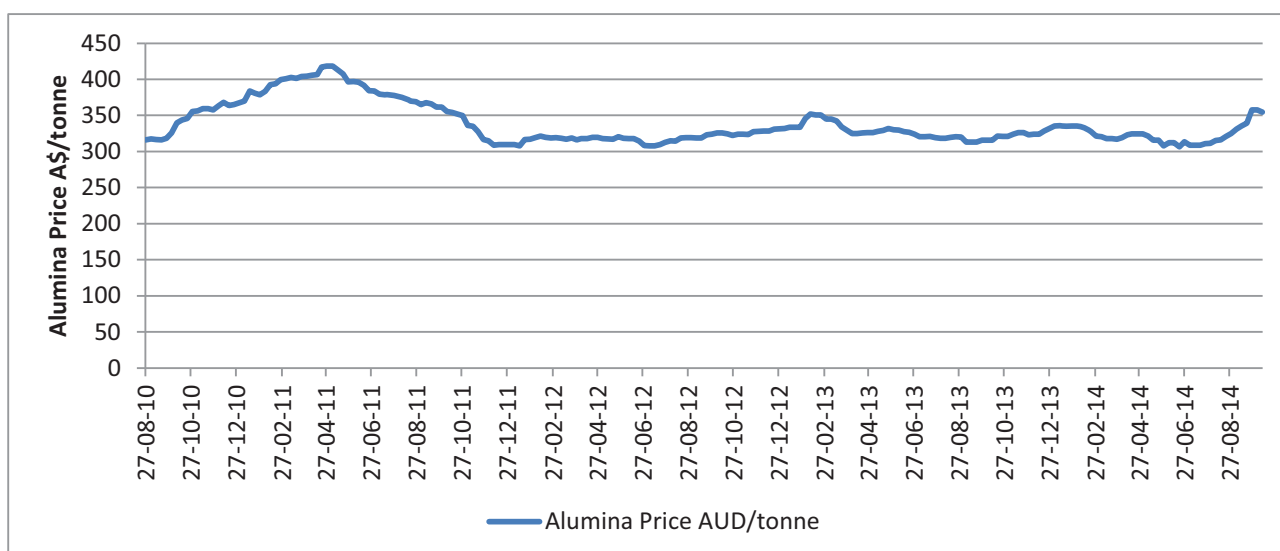

Figure 15-2: Historical Alumina price

15.3 Financial model structure and Inputs

15.3.1 Introduction

SRK has used the Income Based Approach and DCF methodology to determine the Technical Value of the Ore Reserves of BWAPL. SRK has developed a financial model (the **Financial Model**) based on the base case financial model developed by BHP Billiton and where appropriate including various adjustments to the forecasted production, operating expenditure and capital expenditure line items.

The model has been prepared on the basis of BHP Billiton's 86% ownership stake in BWAPL and as such, represents this value only.

SRK has relied upon certain financial information provided by BHP Billiton inclusive of that included in public domain reporting as well as management accounts. Furthermore, in preparing the Financial Model, and consequently deriving the Technical Value of the Ore Reserve for BWAPL, SRK has relied on various inputs, the nature of and underlying rationale for which is discussed below.

15.3.2 Model assumptions

- The Working Capital assumptions included in the model are 30 days for both debtors and creditors
- Depreciation has been calculated using a diminishing value method of tax depreciation
- Royalty revenue has been calculated using 1.65% of the value per tonne
- A Corporate Tax Rate of 30% was used in after tax cash flow (ATCF) calculations
- A flat foreign exchange rate of 0.88c (A\$:US\$) has been used
- Table 15-2 shows the calculations used to determine the Real Discount Rate of 7.7% used in the valuation.

Table 15-2: Discount rate calculation

Risk Free Rate	3.50%
Market Risk Premium	6.28%
Beta	1.5
Cost of Equity	12.92%
Debt Margin	3.00%
Cost of Debt	6.50%
Project Tax Rate	30.00%
Pre-tax cost of debt	4.55%
Target Debt Equity Ratio [D/(D+E)]	30.00%
WACC – Nominal	10.41%
Australia Inflation Rate	2.50%
WACC in real terms	7.72%

15.4 Financial model results

Table 15-3 outlines the inputs and outputs of the Financial Model. Figure 15-3 to Figure 15-8 presents the Financial Model input and output profiles. It should be noted that 2015 is a half year (ie January – June 2015).

Table 15-3: Valuation model (inputs and outputs)

	2015	2016	2017	2018	2019	2020	2021-2031 LOM average
Physicals (Mt)							
Production Alumina (BHP 86%)	2.00	4.02	4.06	4.09	4.13	4.13	4.13
Operating Costs (US\$M)							
C1 Cost	483.5	1,007.3	968.1	964.3	966.0	1,007.1	1,007.7
C2 Cost	633.5	1,291.8	1,237.6	1,218.5	1,203.8	1,232.9	1,188.1
C3 Cost	673.1	1,369.4	1,309.9	1,289.5	1,274.0	1,303.4	1,258.6
Cash Cost Summary (US\$/tAa)							
C1 Cash Cost	242.3	250.3	238.5	235.6	234.0	244.0	244.1
C2 Cash Cost	317.5	321.0	304.9	297.7	291.6	298.7	287.8
C3 Cash Cost	337.3	340.2	322.7	315.0	308.6	315.7	304.9
Capital Costs (US\$M)							
Total Capital	67.0	127.3	138.2	114.9	77.1	122.6	132.0
Revenue (US\$M)							
Revenue	744.2	1,303.4	1,354.1	1,379.3	1,387.9	1,450.2	1,455.7
Taxes & Royalties (US\$M)							
Taxes & Royalties	14.2	28.8	29.3	29.6	30.0	40.2	83.3
After Tax Cash Flow (US\$M)							
ATCF	92.8	109.1	144.2	200.8	246.4	214.8	167.1

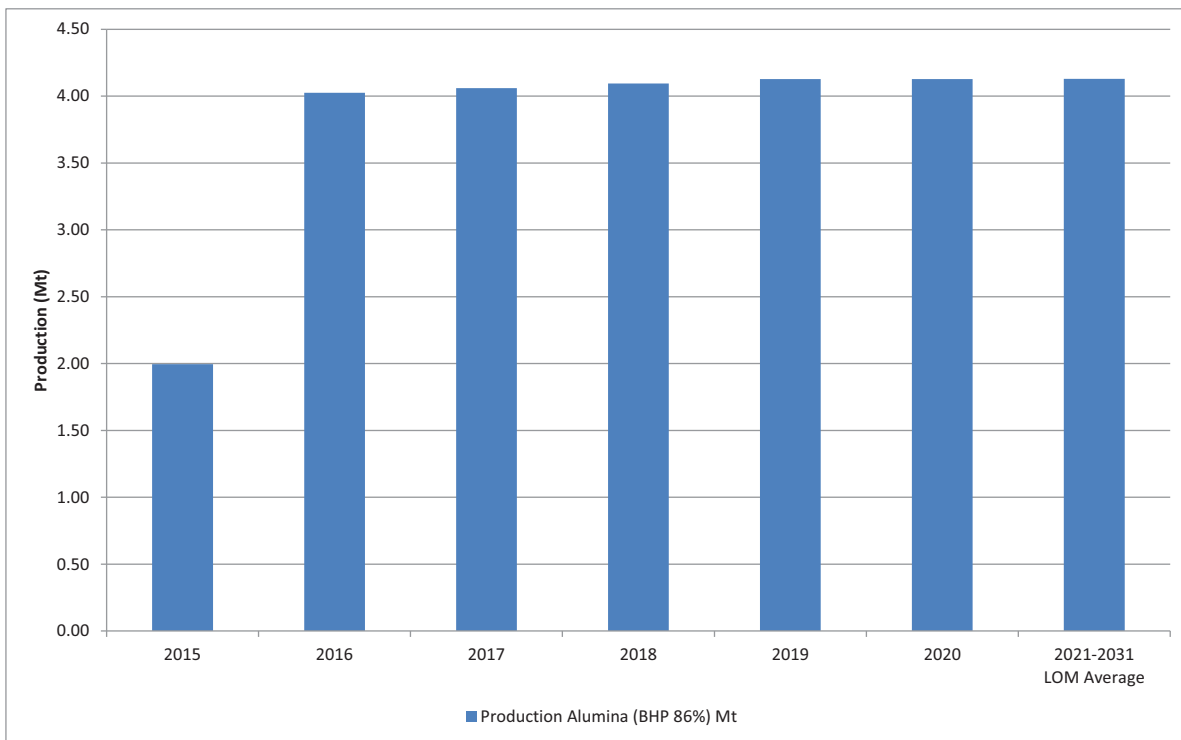

Figure 15-3: Alumina production profile

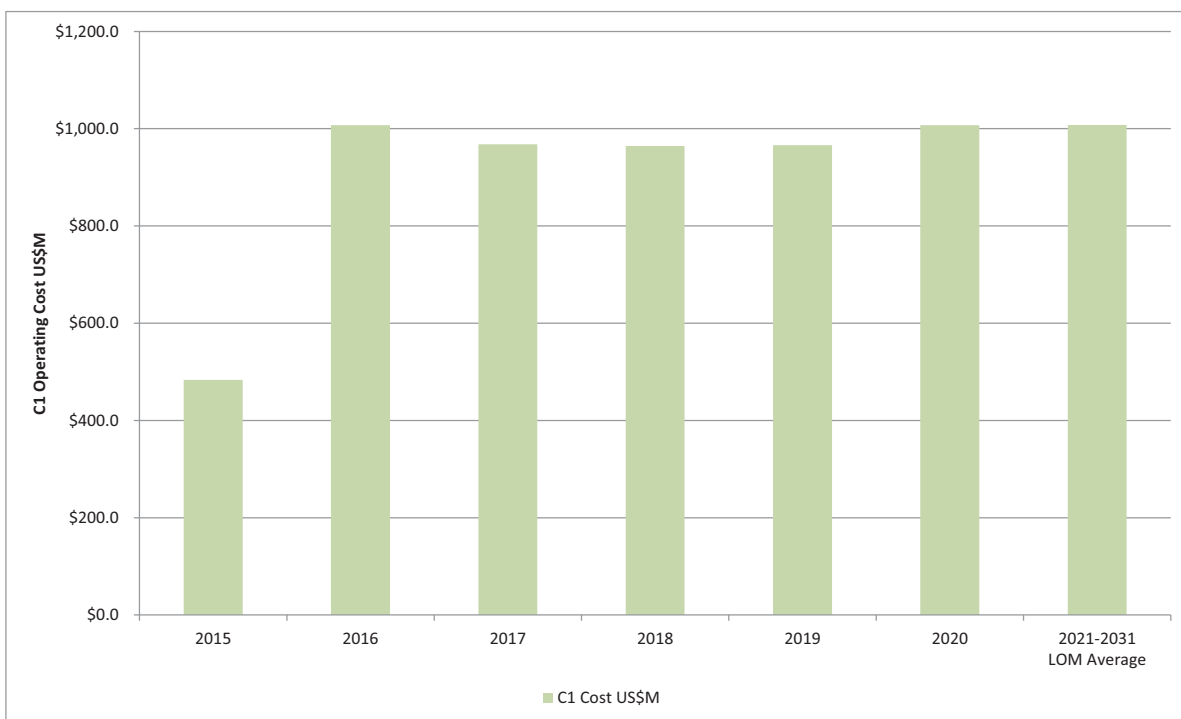

Figure 15-4: Operating cost estimate

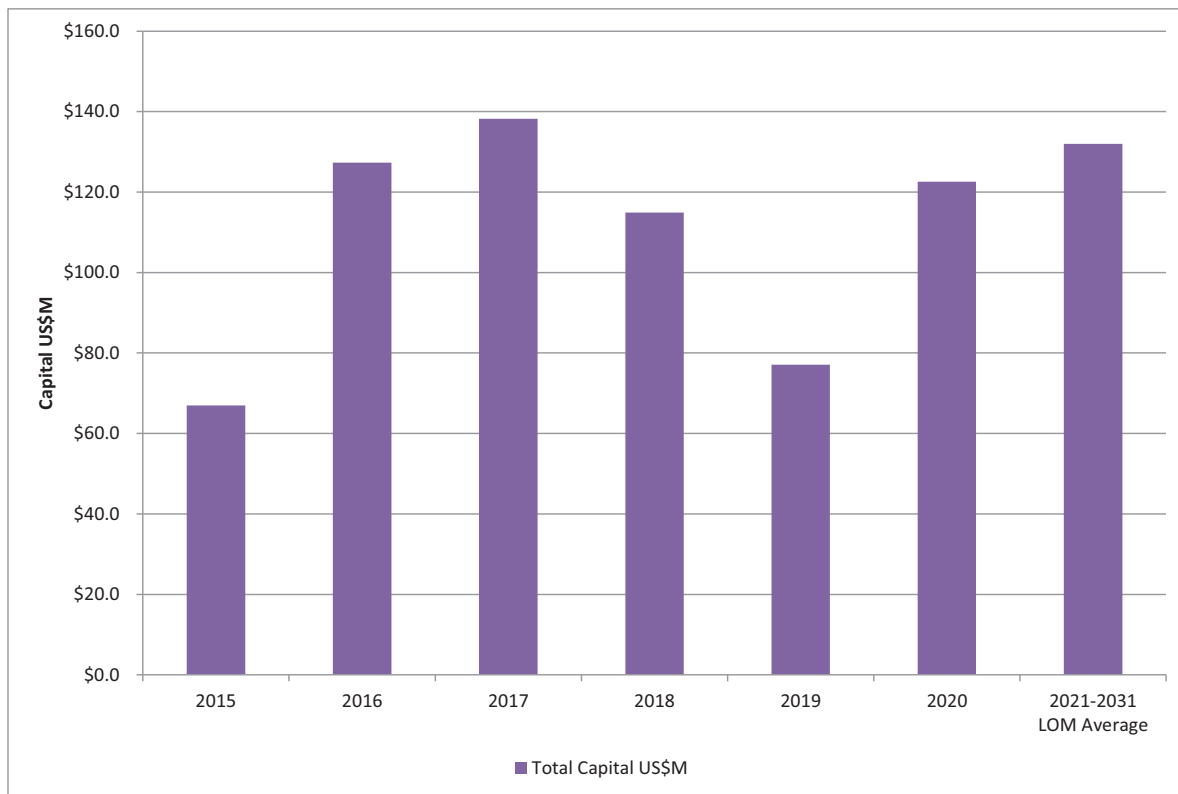

Figure 15-5: Capital cost estimate

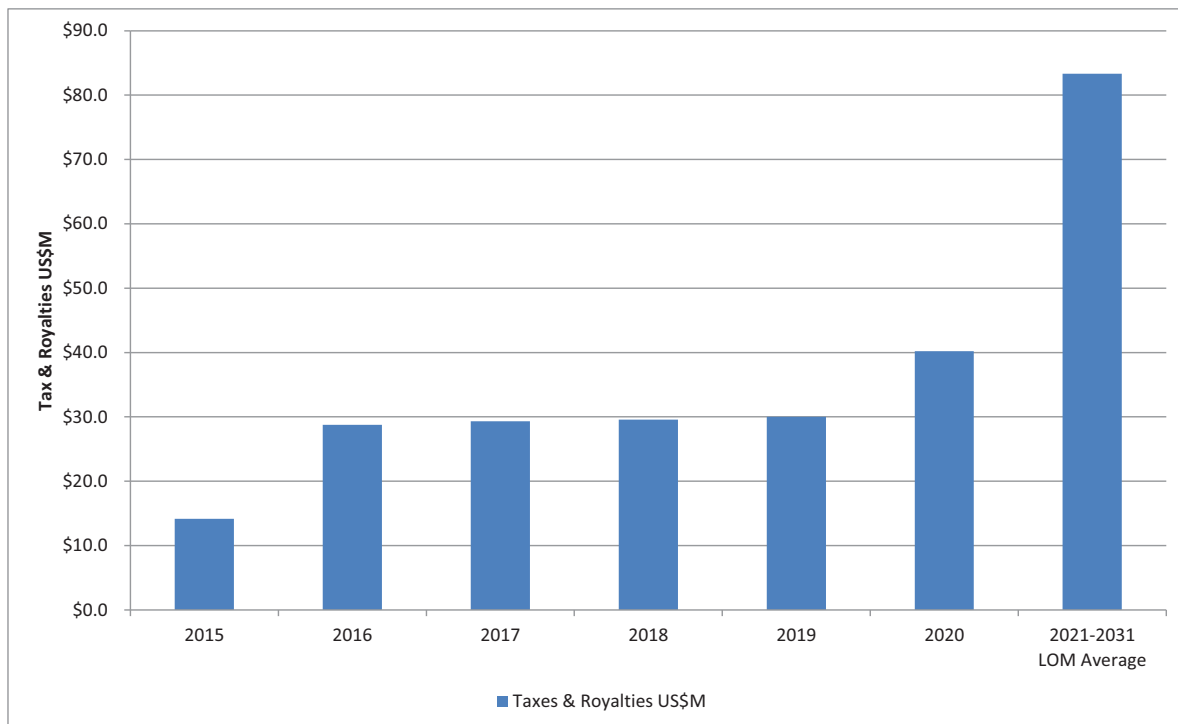

Figure 15-6: Taxes & royalties estimate

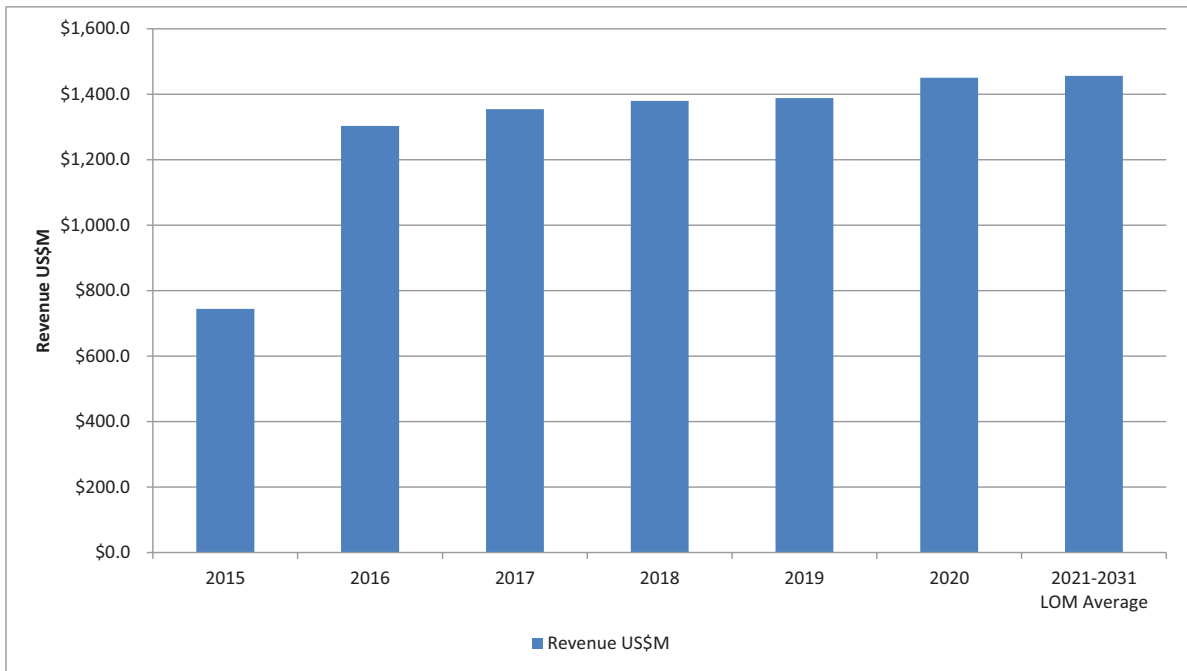

Figure 15-7: Revenue estimate

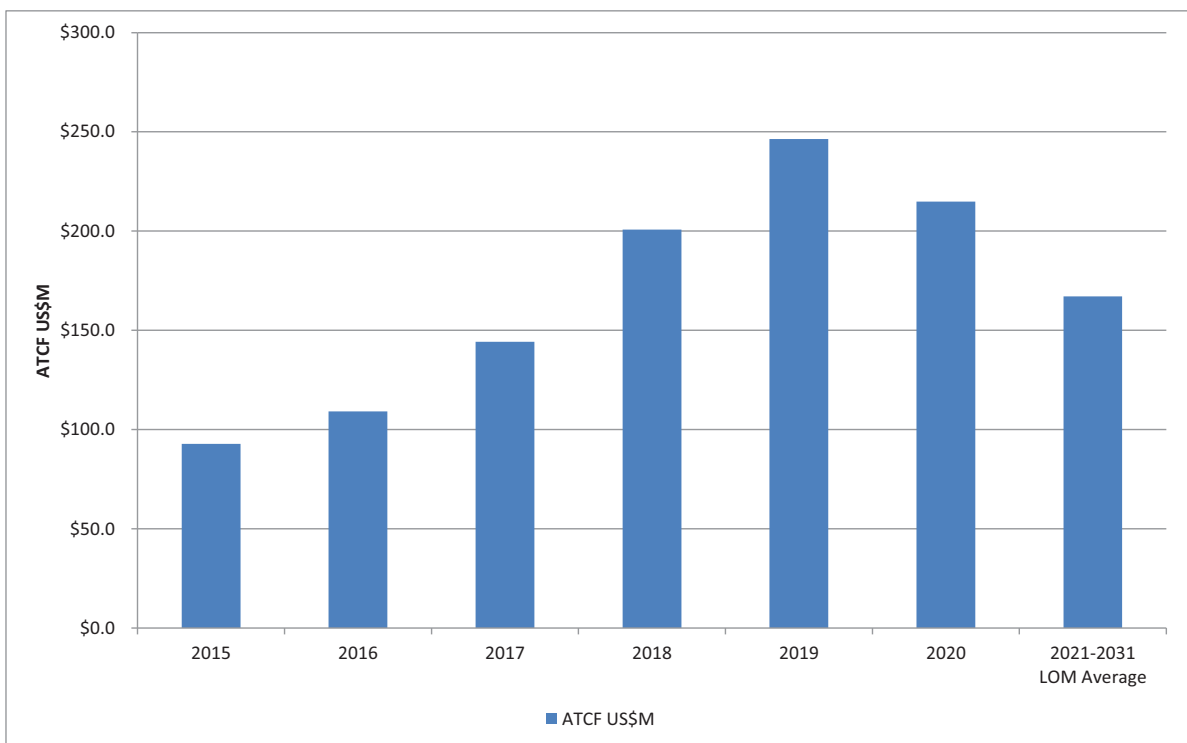

Figure 15-8: ATCF estimate

15.5 Benchmarking

15.5.1 Introduction

The following section includes the results of a cost benchmarking analysis for global Alumina producers. The purpose of the analysis is to ascertain where the 2015 C1 cash cost falls with respect to the various quartiles representing the Alumina mining industry.

15.5.2 Definitions

Cash costs as defined in this report are generally based on the C1 basis which includes all operating costs required to receive the sales revenue as projected. Accordingly the numerator is the summation of the following operating costs: mining (waste+ore), processing, site overheads, transportation costs, treatment charges, refining charges, realisation charges and mineral royalties but will exclude corporate taxation, corporate overheads, environmental closure costs, terminal benefits liabilities, financing charges and all non-cash items such as depreciation and amortization charges. The denominator in the determination of the unit C1 costs is based on the payable unit of metal. With respect to reporting convention, two principal methods are applied:

- By-product reporting - whereby the sales revenue from defined by-products are recorded as a deduction against operating expenses and the resulting numerator is divided by the principal payable product.
- Co-product reporting - whereby the denominator is determined by the summation of equivalent principal payable product. In this case the by-products are converted to equivalent principal payable products based on the ratio of total sales revenue to principal product unit sales revenue.

C2 and C3 costs are typically defined as:

- C2 Cash Cost is the sum of the C1 Cash Cost and depreciation, depletion and amortisation.
- C3 Cash Cost is the sum of the C2 cash cost, indirect costs and net interest charges. The indirect costs include corporate costs, royalties and “front-end” taxes and extraordinary costs such as strikes and unexpected shutdowns.

15.5.3 2015 Cash cost comparison

Figure 15-9 shows the current LOM C1, C2 & C3 Cash Cost profile for BWAPL, also plotted are the Consensus Alumina forecasts used by SRK in this valuation. The forecast C1 Cash Cost for 2015 is US\$242/tA. Figure 15-10 shows the Global C1 Alumina Cash Cost Curve. It can be seen that with a C1 Cash Cost of US\$242/tA, BWAPL is a First Quartile producer on the Global Alumina Cost Curve.

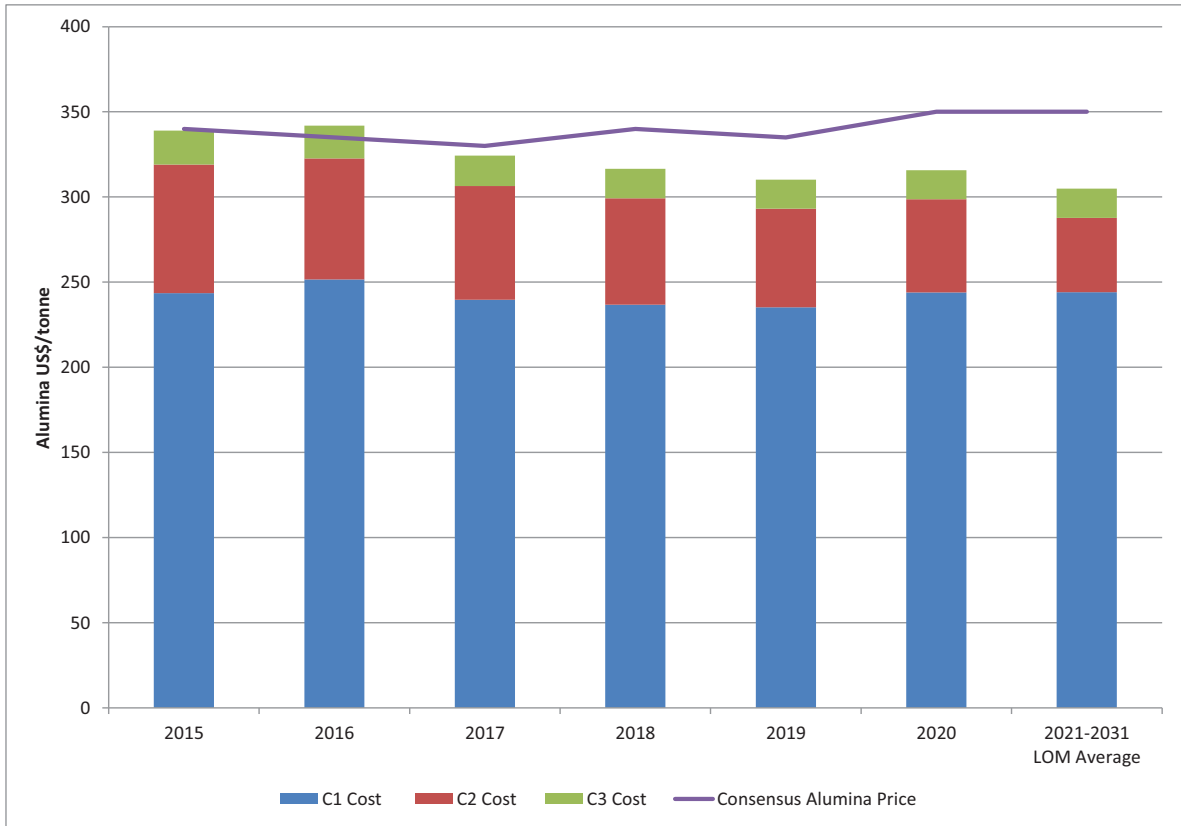

Figure 15-9: LOM cash cost profile

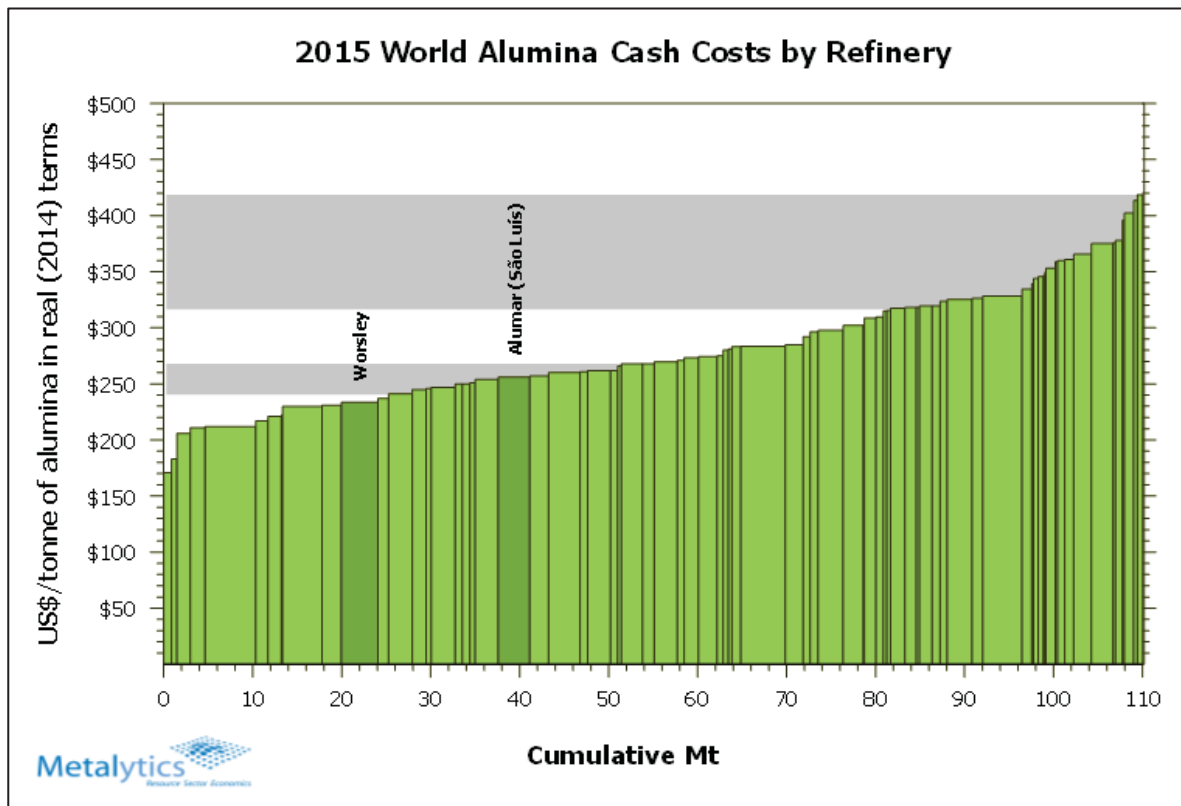

Figure 15-10: C1 Alumina cash costs

Source: Metalytics (2014)

15.6 Discounted cash flow result

Table 15-4 presents the result of SRK's Technical Value of the Ore Reserve for BWALP, based on BHP Billiton's 86% ownership.

SRK values BWALP within the range of US\$1,091M to US\$1,406M, with a preferred value of US\$1,245M (at a real discount rate of 7.7%).

Table 15-4: Valuation summary

SRK Scenario	Discount rate	NPV US\$M
SRK Valuation – Downside	10.7%	1,091.0
SRK Valuation – Preferred	7.7%	1,245.0
SRK Valuation – Upside	4.7%	1,406.9
Internal rate of return	NA	NA

This valuation is reflective of BWAPL, based on SRK's view in relation to Ore Reserves only. It is important to emphasise that this value does not represent the value of the Ore Reserves in the ground in isolation, but rather, incorporates the value of all net assets contributing to the project based on a Reserves production profile. For example, at BWAPL, this includes the value of the mine, truck fleet, conveyors, refinery and port infrastructure.

15.7 Sensitivity analysis

Table 15-5 and Figure 15-11 show the result of SRK's sensitivity analysis based on a Discount Rate of 7.7%. SRK has found the project's NPV to be most sensitive to changes in the operating cost and Alumina price.

Figure 15-12 shows the sensitivity of NPV to changes in Discount Rate.

Table 15-5: Sensitivity analysis

Variance	OPEX	CAPEX	Alumina Price	Ex Rate
25%	(\$1,172)	\$972	\$2,774	(\$521)
20%	(\$689)	\$1,026	\$2,471	(\$119)
15%	(\$205)	\$1,081	\$2,168	\$261
10%	\$278	\$1,136	\$1,863	\$602
5%	\$762	\$1,190	\$1,557	\$928
0%	\$1,245	\$1,245	\$1,245	\$1,245
-5%	\$1,728	\$1,300	\$924	\$1,555
-10%	\$2,212	\$1,354	\$585	\$1,862
-15%	\$2,695	\$1,409	\$207	\$2,167
-20%	\$3,179	\$1,464	(\$220)	\$2,470
-25%	\$3,662	\$1,518	(\$648)	\$2,768

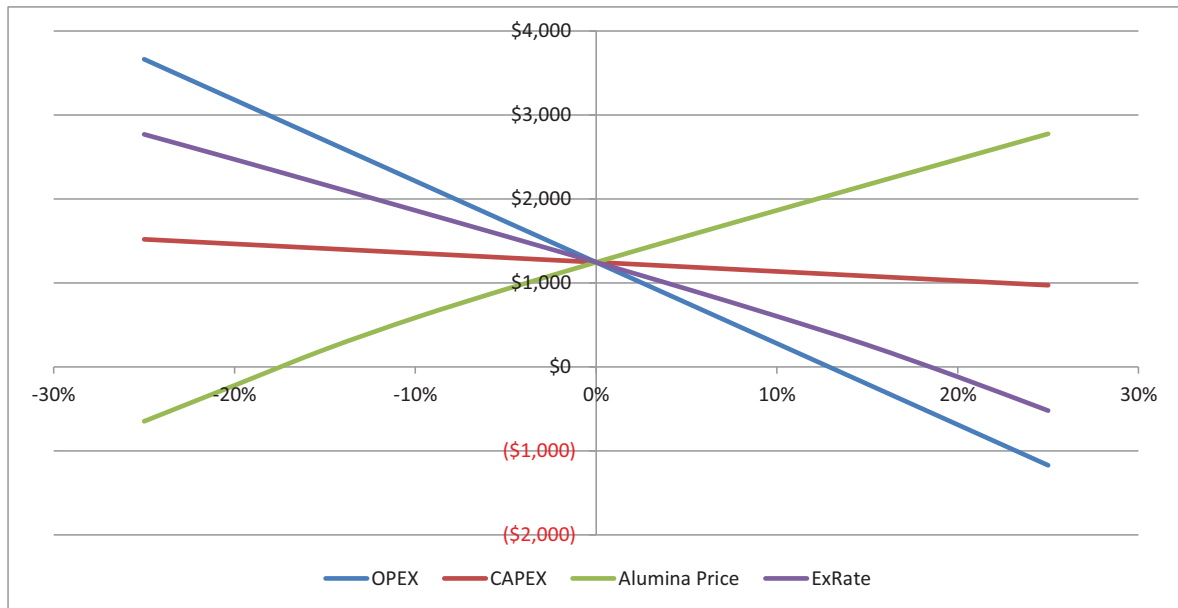

Figure 15-11: Sensitivity analysis

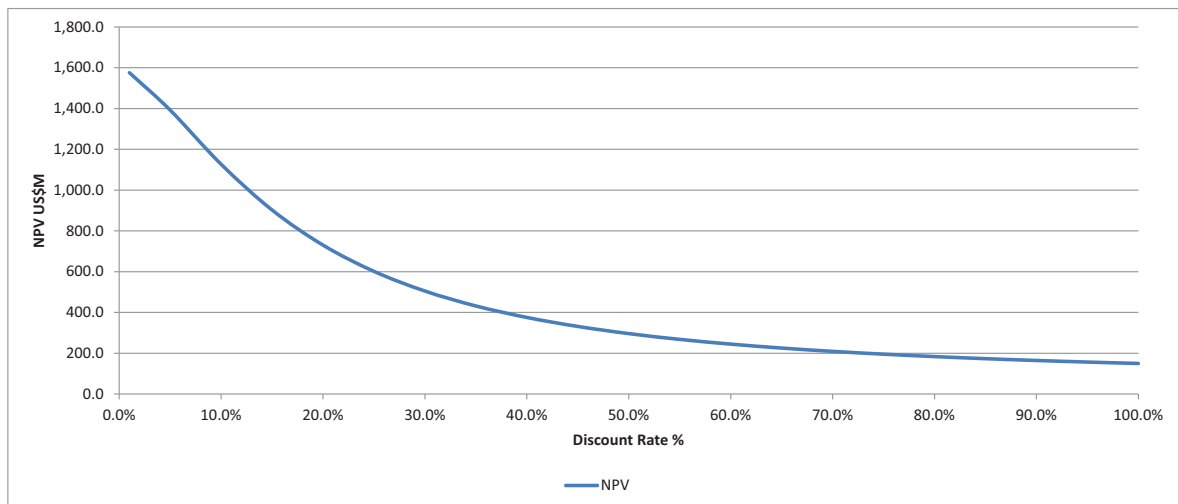

Figure 15-12: NPV versus discount rate

15.8 Comparable transaction analysis

SRK has carried out research into global data bases in order to source data that can be evaluated for comparative transactions as an alternative means of valuing BWAPL. On the basis of this research, there is no comparable set of market transactions such that an equitable comparison could be made.

Accordingly, SRK confirms that on this basis, the DCF methodology is most suitable to provide a valuation for BWAPL due to the fact that BWAPL is a long standing and stable operation with a long life ahead.

15.9 Risks and opportunities

Risks and Opportunities that impact the Technical Value of BWAPL can be defined as:

- Exchange Rate: BWAPL’s NPV is sensitive to fluctuations in the Australian dollar versus United States dollar exchange rate. A 20% increase in the A\$/US\$ exchange rate over the long term will result in a negative NPV for the project.

- Alumina Prices: BWAPL's NPV is sensitive to fluctuations in the price of Alumina. A 20% fall in the Alumina price from current consensus levels will result in a negative NPV.
- Sovereign Risk: There is a risk that a future Australian Government may introduce some form of carbon tax or a revised form of Mining Tax. The introduction of such taxes could negatively affect the projects valuation.
- Industry Competition: Alumina is a competitive industry with little product differentiation. There is a risk that other producers increase production in an attempt to gain market share. This could negatively affect the Alumina price and BWAPL's NPV. A competitive advantage Worsley has is that it is a producer in the first quartile of the cost curve.
- Global Economy: A slowdown in the global economy could affect demand for BWAPL's product.
- Operating Costs: BWAPL is sensitive to changes in Operating Cost, a 12% increase in operating costs will result in a negative NPV. The Australian mining industry is currently experiencing cost deflation as the result reduced development activity in the mining sector. An increase in operating costs is unlikely, and there may be opportunity for Worsley to reduce some operating costs which would have a positive impact on NPV.

15.10 Summary comments

SRK has undertaken a Technical Valuation of the Ore Reserves of BWAPL. SRK's valuation has excluded the valuation of Measured and Indicated Resources (excluding the Ore Reserve) and any Inferred Resources.

SRK values BWAPL within the range of US\$1,091M to US\$1,406M, with a preferred value of US\$1,245M at a real discount rate of 7.7% as at 31 December 2014.

Investors in this company should be aware that the current Technical Valuation of ore reserves is valid at the date of issue. However, future changes in circumstances may affect the valuation either positively or negatively moving forward. Valuations conducted at a future date based on changed circumstances may result in a different result that that obtained by SRK at this valuation date.

16 Concluding Remarks

16.1 Introduction

The following section presents a summary of SRK's opinion in respect of BWAPL, with reference to the 2014 Statements (SRK Depleted) and the Valuation of BWAPL (86% holding). SRK has carried out a comprehensive review and technical assessment of all material issues likely to influence future operations based on the current Ore Reserves.

SRK concludes that the Mineral Resources and Ore Reserves as stated herein are reported in accordance with the terms and definitions of the JORC Code (2012). Mineral Resources are reported inclusive of Ore Reserves.

16.2 Mineral Resources and Ore Reserves

Table 16-1 and Table 16-2 present the Mineral Resources and Ore Reserves (SRK Depleted).

Table 16-1: Mineral Resource as at 31 December 2014 (inclusive of Reserves)

Ore type	Measured Resource			Indicated Resource			Inferred Resource			Total Resource			BHPB interest
	Mdt	A.Al ₂ O ₃ ⁽¹⁾	RxSiO ₂ ⁽²⁾	Mdt	A.Al ₂ O ₃ ⁽¹⁾	RxSiO ₂ ⁽²⁾	Mdt	A.Al ₂ O ₃ ⁽¹⁾	RxSiO ₂ ⁽²⁾	Mdt	A.Al ₂ O ₃ ⁽¹⁾	RxSiO ₂ ⁽²⁾	
Laterite	358	31.1	1.5	355	32	2.3	418	31.2	2.6	1,131	31.4	2.2	86%

Table 16-2: Ore Reserves as at 31 December 2014

31 December 2014	Proved Reserve			Probable Reserve			Total Ore Reserve		
	Mass	Grade	Grade	Mass	Grade	Grade	Mass	Grade	Grade
	Mdt	AAI ₂ O ₃	RXSiO ₂	Mdt	AAI ₂ O ₃	RXSiO ₂	Mdt	AAI ₂ O ₃	RXSiO ₂
Granite derived	52	31.3	2.3	2	31.2	2.5	54	31.3	2.3
Greenstone derived	214.	31.0	1.4	20	30.2	1.6	234	30.9	1.4
Total	266.	31.1	1.6	22	30.3	1.7	288	31.0	1.6

16.3 Valuation

The preferred Technical Value based on BWAPL's Ore Reserves is US\$1.245 billion (86% holding).

This value is derived from the net present value of the after tax cash flows as determined in the financial model, assuming consensus market forecasts and a long term Alumina price of US\$350/t.

16.4 Principal issues

SRK has carried out a detailed technical review of the BWAPL operations and does not find any significant risks that would impact the operational continuity, except for what would be classed as ongoing typical operational risks for this type of operation.

Project Code: BHP151

Report Title: A Competent Person's Report and Valuation on the Boddington Bauxite Mine and Worsley Alumina Refinery, Western Australia

For and on behalf of SRK Consulting (Australasia) Pty Ltd

Competent Person – Mineral Resource



Rodney Brown

Principal Consultant

Competent Person – Ore Reserve



Sjoerd Duim

Principal Consultant

Competent Person – Valuation



Anthony Stepcich

Principal Consultant

List of Abbreviations

Abbreviation	Meaning
5YP	5-year plan
A\$	Australia dollars
A.Al ₂ O ₃	available alumina
ABEA	American Bayer Extractable Alumina
AER(s)	Annual Environmental Report(s)
AH (Act)	Aboriginal Heritage (Act)
Al ₂ O ₃	Aluminium oxide
Alcoa	Alcoa of Australia Ltd
AMPRD	absolute mean percent relative difference
ATCF	after tax cash flow
AusIMM	Australasian Institute of Mining and Metallurgy
BA	Basement
BBM	Boddington Bauxite Mine
BC	Bauxitic Clay
BHPB	BHP Billiton
BRDA(s)	Bauxite Residue Disposal Area(s)
BWAPL	BHP Billiton Worsley Alumina Pty Ltd
BZ	Bauxite Zone
CCCR	Consent, Compensation and Restoration
CL	Crown Leases
CL	Clay
CMF	consensus market forecasts
CP	Chartered Professional
CPR	Competent Person's Report
CS (Act)	Contaminated Sites (Act)
CSA	Contaminated Site Assessment
DCF	discounted cash flow
DER	Department of Environment Regulation
DGPS	differential global positioning system
DGS (Act)	Dangerous Goods Safety (Act)
DMP	Department of Mines and Petroleum
DOLA	Department of Land Administration
DoW	Department of Water
DPaW	Department of Parks and Wildlife
E&G	Efficiency & Growth
EDM	electronic distance measuring
EMLG	Environmental Management Liaison Group
EP (Act)	Environment Protection (Act)
EPA	Environmental Protection Authority
EPBC (Act)	Environment Protection and Biodiversity Conservation (Act)

Abbreviation	Meaning
ERMP	Environmental Review and Management Programme
ESMA	European Securities and Markets Authority
FAC	First Aid Cases
FEL	front end loader
FTIR	Fourier transform infrared
FWL	Freshwater Lake
G	Gravel
GDA94	Map Grid of Australia
GFC	global financial crisis
GL	gigalitres
GPS	global positioning system
GRM	Groundwater Resource Management
GWL	Groundwater Well Licence
ha	hectares
HC	Hardcap
HNE	Hotham North Envelope
HSEC	Health, Safety, Environment and Community
IC	ion chromatography
ICP	Inductively coupled plasma
JORC Code	The 2012 Australasian Code for Reporting of Exploration Results, Mineral Resources and Ore Reserves as published by the Joint Ore Reserves Committee of The Australasian Institute of Mining and Metallurgy, Australian Institute of Geoscientists and Minerals Council of Australia
JSE	Johannesburg Stock Exchange
kg/t	kilograms per tonne
kg/tA	kilograms per tonne alumina
kL	kilolitres
KNA	Kriging neighbourhood analysis
kt	kilotonnes
LOMP(s)	Life of Mine Plan(s)
LSE	London Stock Exchange
LTP	long-term price
Mdt	million dry tonnes
Mdt	million dry tonnes
ML	Mining Lease
ML	megalitres
ML/a	million litres per year
MME	Marradong Mining Envelope
MMW	minimum mining width
MRE	Mineral Resource estimation
MRF (Act)	Mining Rehabilitation Fund (Act)
Mt	million tonnes
Mtpa	million tonnes per annum

Abbreviation	Meaning
MtpaA	million tonnes per annum alumina
NPV	net present value
NYSE	New York Stock Exchange
OBC	overland bauxite conveyor
OHS	Occupational health and safety
PBA	Primary Bauxite Area
PP & E	plant, property and equipment
QA/QC	quality assurance/ quality control
QQ	quantile-quantile
R.SiO ₂	reactive silica
RCL	Refinery Catchment Lake
RIWI (Act)	Rights in Water and Irrigation (Act)
ROM	Run of Mine
SGA	smelter grade alumina
SME	Saddleback Mining Envelope
SMU	selective mining unit
SRK	SRK Consulting (Australasia) Pty Ltd
SWCJV	South West Cogeneration Joint Venture
SWIS	South West Integrated System
t/m ³	tonnes per cubic metre
TEP	technical and economic parameter
TOC	total organic carbon
tonnes alumina	tA
tph	tonnes per hour
TRIF	Total Recordable Injury Frequency Rate
TSF	tailings storage facility
UKLA	United Kingdom Listing Authority
US\$	United States dollars
VALMIN Code	Code for the Technical Assessment and Valuation of Mineral and Petroleum Assets and Securities for Independent Expert Reports: The VALMIN Code (2005 Edition)
WA	Western Australia
WAR	Worsley Alumina Refinery
WDIE	Worsley Design Indicated Extraction
WJV	Worsley Joint Venture
wkt	wet kilotonnes
WLAA	Worsley Laboratory Available Alumina
XRF	X-ray fluorescence

ANNEXURE 6

INDEPENDENT COMPETENT PERSONS' REPORTS

- 2. South Africa Energy Coal – Xstract Mining Consultants
-



11 March 2015

The Directors
South32 Limited
Level 20
Waterfront Place
1 Eagle Street
BRISBANE QLD 4000
Australia

The Directors
BHP Billiton Limited
BHP Billiton Centre
171 Collins Street
MELBOURNE VIC 3000
Australia

The Directors
BHP Billiton Plc
Neathouse Place
London WS1V 1LH
United Kingdom

Dear Sirs

Re: Competent Persons Report

At the request of South32 Limited ("South32"), Xstract Mining Consultants Pty Ltd ("Xstract") has prepared this Competent Persons Report on the coal assets of South Africa Energy Coal ("SAEC"), currently held within BHP Billiton Energy Coal South Africa Pty Ltd ("BECSA").

Xstract understands that this report is to be included in documentation relating to the demerger from BHP Billiton Limited and BHP Billiton Plc ("BHP Billiton"), and subsequent listing of South32 on the Australian Securities Exchange ("ASX"), the Johannesburg Stock Exchange ("JSE"), and on the Official List of the United Kingdom Listing Authority ("UKLA") (collectively, the Relevant Listing Authorities).

Furthermore, Xstract understands this documentation comprises an ASX Information Memorandum, a JSE pre-listing statement and a UK prospectus (the "Listing Documentation").

The purpose of this report is to provide a technical opinion as to the reasonableness of the information supporting SAEC's coal assets. The focus of the review is on the technical aspects of SAEC's assets: including tenure, geology, Coal Resource/Coal Reserve statements, mine plans, production rates, infrastructure, environment, social, capital/operating cost estimates, risks, opportunities and uncertainties. It includes a valuation of SAEC's currently defined Coal Reserves.

This Competent Persons Report summarises the findings of Xstract's review and has been prepared in order to satisfy the rules and requirements of the Relevant Listing Authorities, including, in the case of a UKLA listing; the European Securities and Market Authority's ("ESMA") Recommendations on consistent implementation of Commission Regulation (EC) No 809/2004, implementing the Prospectus Directive (the "ESMA Recommendations", as revised in March 2013).

Xstract – Excellence from the outset

XstractGroup.com

This report has been prepared in compliance with internationally accepted mineral reporting codes, these being:

- The 2012 Edition of the "Australasian Code for Reporting of Exploration Results, Mineral Resources and Ore Reserves" (the "JORC Code")
- The 2005 Edition of the "Code for the Technical Assessment and Valuation of Mineral and Petroleum Assets and Securities for Independent Expert Reports" (the "VALMIN Code")

In addition, this report recognises the 2009 Edition of *"The South African Code for the Reporting of Exploration Results, Mineral Resources and Mineral Reserves"* (the "SAMREC Code") and Edition 1 of the *"South African guide to the systematic evaluation of coal resources and coal reserves, South African National Standard SANS 10320:2004"* (the "Coal Guidelines").

The Coal Guidelines together with the JORC and SAMREC Codes establish the nature of evidence required to report Exploration Results, Coal Resources and Coal Reserves in a public document, while the VALMIN Code outlines the key elements to be considered in evaluating and valuing mineral assets and securities.

The principal assets held by SAEC reside in the Witbank, Highveld and Ermelo Coalfields of South Africa and comprise the Wolvekrans-Middelburg, Klipspruit and Khutala thermal coal mining and processing operations, in addition to the Klipspruit Extension, Leandra North, Leandra South and Naudesbank thermal coal development projects and various other exploration projects. These projects are discussed in this Competent Persons Report.

Xstract is an independent mining consultancy offering expertise in a wide range of resource and engineering disciplines. Xstract has a demonstrated track-record in undertaking independent assessments of resources/reserves, due diligence, capital raising reports, and independent feasibility evaluations on behalf of exploration/mining companies and financial institutions worldwide.

This Competent Persons Report has been prepared based on a technical and economic review by a team of consultants sourced from Xstract's staff and associate network over a three-month period. These consultants are specialists in the fields of geology, resource/reserve estimation, open pit mining, rock engineering, mineral processing, hydrogeology/ hydrology, tailings management, infrastructure, environmental management and mineral asset valuation.

The individuals listed below have provided input to the Competent Persons Report. Each has extensive experience in the mining industry and is a member in good standing of appropriate professional institutions:

- Kevin Irving, MBA, BSc, FAusIMM(CP), FIMMM(CEng), MAICD, is General Manager - Mining with Xstract and has practised his profession as a mining engineer for over 35 years, predominantly in coal, with extensive experience in due diligence, technical reviews and mine design/planning.
- Jeames McKibben, MBA, BSc (Hons), MAusIMM(CP), MAIG, is General Manager – Corporate Advisory with Xstract and has over 20 years' international experience in the mining industry, with significant experience in technical reviews, due diligence assessments and valuation of mineral assets.
- Ian de Klerk, MSc (Expl Geol), GradDipEng (Mining), MAusIMM is a Principal Consultant – Geology with Xstract and has over 24 years' coal experience specialising in due diligence, technical reviews, exploration advice and coal resource estimation and reporting under international mineral reporting codes.
- Donald Elder, NHD Mineral Resource Management, GDE Mining Engineering, MAusIMM is a Principal Consultant – Mining with Xstract and has over 20 years' experience in the

- field of Mineral Resource Management, with significant experience in mining operations, feasibility studies and due diligence assessments.
- Mat Longworth, BSc (Hons), MAusIMM, MAICD is General Manager – Corporate Advisory with Xstract and has over 25 years’ experience across exploration, project evaluation/development, operations and corporate management.
 - Richard Marshall MBA, BE (Minerals Process), MAusIMM(CP) is a Principal Consultant with over 18 years’ in coal processing with extensive experience in due diligence, study management, process design, construction , commissioning and operations.
 - Shaun Barry, BSc (Hons), MSc(MinEcon), MAusIMM is an Associate Consultant – Project Evaluations and has over 24 years’ international experience in the minerals industry that includes mining business evaluation, sales, marketing, strategy development and geology.
 - Mark Bowater, BE(Civil), BBus is an Associate Consultant with over 25 years’ experience in the open cut mining industry, primarily in coal, with significant mining engineering experience in design, scheduling, financial analysis and technical and operational studies.
 - Michael Creech, BSc, MSc, PhD, MAusIMM(CP) is an Associate Consultant – Geology and has over 30 years’ experience in the mining industry with over 25 years in the coal industry.
 - Graham Trusler, MSc (Eng), BComm, Registered Professional Engineer, MSAIChE, MWISA, MASMR, is CEO and Consultant – Environment with Digby Wells and has over 21 years’ experience as an environmental specialist to the mining industry and previously in metallurgical production.
 - Bradly Thornton, BSc (Hons) is Divisional Manager: Human Sciences with Digby Wells Environmental and has over 7 years’ international experience as an environmental specialist.

The Listing Documentation contains an appropriate summary of each of the assets, and Xstract is satisfied with the integrity of the information contained in the Listing Documentation based on our experience and the limited validation work performed by Xstract.

Drafts of this report were provided to SAEC, but only for the purposes of confirming the accuracy of factual material and the reasonableness of assumptions relied upon in the report.

Xstract has given and not withdrawn its written consent to issue the Listing Documentation with its name included within and to the inclusion of this report and references to this report and the Listing Documentation. Xstract accepts responsibility for the information contained within this report as set out in this section, in the form and context in which the report is included, of the Listing Documentation and those parts of the Listing Documentation which include references to this report.

Jeames McKibben qualifies as a Representative Expert under the VALMIN Code and as a Competent Person under the JORC Code. He has supervised the preparation of this report and accepts overall responsibility for it under Section 37 of the VALMIN Code. Mr McKibben has relied on Mr Ian de Klerk (Coal Resources) and Mr Kevin Irving (Coal Reserves) as Xstract’s Competent Persons, who accept responsibility for the Coal Resources and Coal Reserves sections of this report as required under Section 4 of the JORC Code. Xstract notes that the Coal Resource and Reserve estimates and statements have been prepared and publicly disclosed previously in BHP Billiton’s 2014 Annual Report and signed off by BHP Billiton’s Competent Persons as noted elsewhere in this report.

Xstract accepts responsibility for this letter and the Competent Persons Report and, to the best of Xstract's knowledge, having taken all reasonable care to ensure the information contained in its report is in accordance with the facts and contains no omission likely to affect its import.

Yours sincerely

A copy of this electronic signature is held on file at Xstract Mining Consultants Pty Ltd - not for use by external parties. A copy of this electronic signature is held on file at Xstract Mining Consultants Pty Ltd - not for use by external parties.

Jeames McKibben

General Manager & Principal Consultant – Corporate Advisory
Xstract Mining Consultants Pty Ltd

Telephone: +61 7 3221 2366
Fax: +61 7 3221 2235
Email: jmckibben@xstractgroup.com



South Africa Energy Coal (SAEC)

Competent Persons Report

Prepared for:
South32 Limited
Effective Date: March 2015
FINAL

XstractGroup.com

Xstract - Excellence from the outset



Project Manager:

Kevin Irving
BSc, MBA
FAusIMM, FIMMM(CEng), MAICD
General Manager and Principal Consultant – Mining
Xstract Mining Consultants, Brisbane

Contributing authors:

J McKibben¹, I de Klerk², R Marshall³, S Barry⁴, M Creech⁵, G Trusler⁶

Peer review of technical work by:

M Longworth⁷

Report reviewed by:

R Jasen⁸

Client name and address:

South32 Limited
Level 10, Waterfront Place
1 Eagle Street
BRISBANE QLD 4000

Xstract Mining Consultants Pty Ltd has prepared this report on behalf of South32 Limited. Public disclosure, publication, or presentation of any information contained in this document must be accompanied by written consent from Xstract Mining Consultants Pty Ltd.

© Xstract Mining Consultants Pty Ltd 11/03/2015

¹ General Manager & Principal Consultant – Corporate Advisory, Xstract Mining Consultants, Brisbane

² Principal Consultant - Geology, Xstract Mining Consultants, Brisbane

³ Associate Consultant – Coal Processing, Endellion Technology Pty Ltd, Brisbane

⁴ Associate Consultant – Economic Evaluation, Brisbane

⁵ Associate Consultant – Coal Geology, GeoCreecher, Brisbane

⁶ Associate Consultant – Environment, Digby Wells, Johannesburg

⁷ General Manager & Principal Consultant – Xstract, Xstract Mining Consultants, Perth

⁸ Technical Editor, Xpert Editorial, Brisbane

Xstract Mining Consultants Pty Ltd
ABN: 62 129 791 279

Brisbane, Australia
Ground Level, 545 Queen Street
BRISBANE QLD 4000
PO Box 10312
BRISBANE ADELAIDE STREET QLD 4000
T +61 7 3221 2366 | F +61 7 3221 2235

Perth, Australia
Level 11, 140 St Georges Terrace
PERTH WA 6000
PO Box Z5426
PERTH WA 6831
T +61 8 9327 9500 | F +61 8 9481 8700

Adelaide, Australia
T +61 8 7087 2152
Newcastle, Australia
T +61 61 7 3221 2366
Ulaanbaatar, Mongolia
T +976 7744 0000

XstractGroup.com
Xstract - Excellence from the outset

London, United Kingdom
T +44 207 002 1012

Internet
www.xstractgroup.com
enquiries@xstractgroup.com



Document information:

Project reference:	P2084
Reporting standard/s:	JORC Code 2012, VALMIN Code 2005
Effective date:	11 March 2015
Status:	Published
File/version:	P2084_SAEC_MER_Final_20150313.docx
Distributed to:	Ben Armstrong, BHP Billiton
Document format:	Electronic via FTP Site, Microsoft Word Document
Delivered to:	Ben Armstrong

Final approvals/signatures:

	Name, Title, Company	Date	Signature
Authors:	Jeames McKibben General Manager & Principal Consultant – Corporate Advisory	11 March 2015	A copy of this electronic signature is held on file at Xstract Mining Consultants Pty Ltd – not for use by external parties. A copy of this electronic signature is held on file at Xstract Mining Consultants Pty Ltd – not for use by external parties.
	Ian de Klerk Principal Consultant – Geology	11 March 2015	A copy of this electronic signature is held on file at Xstract Mining Consultants Pty Ltd – not for use by external parties. A copy of this electronic signature is held on file at Xstract Mining Consultants Pty Ltd – not for use by external parties.
	Richard Marshall Associate Consultant – Coal Processing	11 March 2015	A copy of this electronic signature is held on file at Xstract Mining Consultants Pty Ltd – not for use by external parties. A copy of this electronic signature is held on file at Xstract Mining Consultants Pty Ltd – not for use by external parties.
	Graham Trusler Associate Consultant – Environmental	11 March 2015	A copy of this electronic signature is held on file at Xstract Mining Consultants Pty Ltd – not for use by external parties. A copy of this electronic signature is held on file at Xstract Mining Consultants Pty Ltd – not for use by external parties.
	Shaun Barry Associate Consultant – Economic Evaluation	11 March 2015	A copy of this electronic signature is held on file at Xstract Mining Consultants Pty Ltd – not for use by external parties. A copy of this electronic signature is held on file at Xstract Mining Consultants Pty Ltd – not for use by external parties.
Peer Reviewer:	Mathew Longworth General Manager & Principal Consultant – Xstract	11 March 2015	A copy of this electronic signature is held on file at Xstract Mining Consultants Pty Ltd – not for use by external parties. A copy of this electronic signature is held on file at Xstract Mining Consultants Pty Ltd – not for use by external parties.
Project Manager:	Kevin Irving General Manager & Principal Consultant – Mining	11 March 2015	A copy of this electronic signature is held on file at Xstract Mining Consultants Pty Ltd – not for use by external parties. A copy of this electronic signature is held on file at Xstract Mining Consultants Pty Ltd – not for use by external parties.

XstractGroup.com

Xstract - Excellence from the outset

Contents

1	Covering letter _____	1
2	Executive summary _____	1
	2.1 SAEC	1
	2.2 Geological setting	4
	2.3 Coal Resources and Coal Reserves	4
	2.4 Mining asset overview	6
	2.5 Development assets	12
	2.6 Exploration assets	14
	2.7 Infrastructure	15
	2.8 Environment	16
	2.9 Costs	19
	2.10 Market analysis	21
	2.11 Risks and opportunities	21
	2.12 Valuation	27
3	Introduction _____	29
	3.1 Background	29
	3.2 Review process	30
	3.3 Structure	31
	3.4 Compliance	32
	3.5 Data sources	33
	3.6 Competent Persons statement	33
	3.7 Reliance statements	33
	3.8 Independence, disclaimer and warranty	35
4	SAEC _____	36
	4.1 Overview	36
	4.2 Location, access and local resources	42
	4.3 Climate, physiography and land use	44
	4.4 Tenure	45
	4.5 Regional geology	51
	4.6 Coal Resource and Coal Reserve statements	54
	4.7 Overview of data supporting the estimates	58
5	Mining assets _____	66
	5.1 Introduction	66
	5.2 Wolvekrans-Middelburg Complex	66
	5.3 Klipspruit	120

5.4	Khutala	145
6	Development assets	172
6.1	Introduction	172
6.2	Klipspruit Extension	172
6.3	Leandra (North and South)	181
6.4	Naudesbank	186
7	Exploration assets	189
8	Market analysis	190
8.1	Macro-economic analysis	190
8.2	Pricing	193
9	Special factors	194
9.1	Mine Closure Closed Mines (“MCCM”)	194
9.2	Adjacent projects	197
9.3	Other relevant data and information	198
10	Valuation of Coal Reserves	201
10.1	Valuation methodology	201
10.2	Discounted cash flow	202
10.3	Valuation of Wolvekrans-Middelburg	205
10.4	Valuation of Klipspruit	209
10.5	Valuation of Khutala	212
10.6	Sensitivity analysis	214
10.7	Market support	214
10.8	Other considerations	217
10.9	Valuation summary	218
11	Concluding remarks	219
12	Consultant qualifications and experience	220
13	References	223
13.1	Internal SAEC Documents	223
13.2	Public documents	224
14	Glossary	227

Tables

Table 2.1: Summary of SAEC’s Material Assets as at 31 December 2014	3
Table 2.2: SAEC Coal Processing Capacity	3
Table 2.3: SAEC’s Coal Resources and Coal Reserves as at 30 June 2014 (adb) on 100 per cent terms	5
Table 2.4: Summary of Marketable Reserve product split (adb), as at 30 June 2014	6

Table 2.5: Key thickness and raw coal quality assumptions supporting the Coal Resources and Coal Reserve estimates	6
Table 2.6: Overview of SAEC's Mining Assets	8
Table 2.7: Status of SAEC's Development Assets	12
Table 2.8: Status of SAEC's Exploration Assets	15
Table 2.9: Summary of SAEC Mine Closure Closed Mines (excluding Douglas)	18
Table 2.10: SAEC – Capital Cost estimate (real)	19
Table 2.11: SAEC (WMC) – Operating Cost estimate (real)	20
Table 2.12: SAEC (Klipspruit) – Operating Cost estimate (real)	20
Table 2.13: SAEC (Khutala) – Operating Cost estimate (real)	20
Table 2.14: Identified Strengths, Weaknesses, Opportunities and Threats to SAEC's business	26
Table 2.15: Summary - Value of SAEC Coal Reserves (100 per cent terms)	28
Table 2.16: Summary of SAEC NPV per Reserve multiple	29
Table 2.17: Assigned Value of the defined Coal Reserves on 100 per cent terms	29
Table 3.1: Summary of Xstrat's site visits	31
Table 3.2: Consultant shareholdings in BHP Billiton as at 16 January 2015	36
Table 4.1: Drilling expenditures by development status (ZAR M)	42
Table 4.2: Types of rights applicable in South Africa	46
Table 4.3: Schedule of SAEC's Mining Rights	49
Table 4.4: Schedule of SAEC's Prospecting Rights	49
Table 4.5: Schedule of SAEC Prospecting Rights subject to a Sale Agreement	50
Table 4.6: Simplified stratigraphy of the Karoo Basin	52
Table 4.7: Coal Resources as at 30 June 2014 (adb) in 100 per cent terms	55
Table 4.8: Coal Resources as at 31 December 2014 (adb) in 100 per cent terms	56
Table 4.9: Coal Reserves as at 30 June 2014 (adb) in 100 per cent terms	57
Table 4.10: Coal Reserves as at 31 December 2014 (adb) in 100 per cent terms	57
Table 4.11: Technical cut-off parameters	58
Table 4.12: Reserve reconciliation table for periods	65
Table 5.1: Wolvekrans Mine Coal Resources (adb), as at 30 June 2014 on 100 per cent terms	79
Table 5.2: Middelburg Mine Coal Resources (adb), as at 30 June 2014 on a 100 per cent basis	81
Table 5.3: Wolvekrans Coal Reserves (adb)	83
Table 5.4: Wolvekrans Inferred Resource by pit (adb)	84
Table 5.5: Middelburg Coal Reserves (adb)	85
Table 5.6: Geologic Losses	86
Table 5.7: Seam Losses and Dilution	86
Table 5.8: Thickness Rules	87
Table 5.9: Seam Losses and Dilution	88

Table 5.10: Thickness Rules	88
Table 5.11: Wolvekrans and Middelburg Mines - Wall Stability Incidents	89
Table 5.12: WMC Marketable Reserve tonnes scheduled according to product split, at 30 June 2014	94
Table 5.13: BCP South Export Plant Production Statistics	100
Table 5.14: BCP North Export Plant Production Statistics	101
Table 5.15: BCP North Middlings Plant Production Statistics	102
Table 5.16: BCP South Eskom Plant Production Statistics	102
Table 5.17: BCP VDD Mobile Plant Production Statistics	103
Table 5.18: Wolvekrans Major Mining equipment fleet	104
Table 5.19: Middelburg Major Mining equipment fleet	105
Table 5.20: BCP Historical and Budgeted Manning Levels	106
Table 5.21: Wolvekrans-Middelburg – real average mining cost	116
Table 5.22: Wolvekrans-Middelburg – forecast mining cost (real)	116
Table 5.23: BCP Actual Operational Expenditure	116
Table 5.24: BCP Forecast Operational Expenditure (real)	116
Table 5.25: Klipspruit Coal Resources (adb), as at 30 June 2014 on 100 per cent terms	125
Table 5.26: Seam Modifying Factors and Recovery Factors	126
Table 5.27: Klipspruit Mine Reserves by area	126
Table 5.28: Klipspruit Coal Reserves (adb)	127
Table 5.29: Major Mining equipment fleet	130
Table 5.30: Klipspruit Production Schedule FY15 to FY20	131
Table 5.31: Phola SAEC Production Statistics	135
Table 5.32: Klipspruit real average mining cost	141
Table 5.33: Forecast mining costs (real)	141
Table 5.34: Klipspruit Capital Expenditure and closure cost (real)	143
Table 5.35: Khutala Mine Coal Resources (adb), as at 30 June 2014 on a 100 per cent basis (No.4U and No.2 Seams assigned to Eskom, No.5 Seam assigned to SAEC)	151
Table 5.36: Seam Modifying Factors	152
Table 5.37: Khutala Mine Underground Coal Reserves by seam (adb)	153
Table 5.38: Khutala Mine Underground Coal Reserves (adb)	154
Table 5.39: Khutala Mine Opencast Coal Reserves (adb)	154
Table 5.40: SAEC's Underground Mining Equipment Fleet	157
Table 5.41: No.2 and No.4 Seam design summary	158
Table 5.42: Eskom coal specifications for Khutala mine	163
Table 5.43: Historic actual underground mining costs	167
Table 5.44: Forecast underground mining costs (nominal)	167
Table 5.45: Khutala Capital Expenditure (real)	167

Table 6.1: Weltevreden Coal Resources on a seam basis as at 30 June 2014 (adb)	175
Table 6.2: Leandra Coal Resources on a Seam Basis (adb)	185
Table 6.3: Resources for Naudesbank Project on a seam basis (adb)	189
Table 9.1: Summary of SAEC Mine Closure Closed Mines (excluding Douglas)	195
Table 9.2: Closure Liability per mine -DMR Submission as at 30 June 2013	199
Table 9.3: SAEC's current provisions	200
Table 9.4: SAEC's calculated liability	200
Table 9.5: Rehabilitation expenditure (next 5 financial years)	201
Table 10.1: Valuation approaches for different types of mineral assets	202
Table 10.2: Inflation and Exchange rate forecast	203
Table 10.3: Export coal price forecast (nominal)	203
Table 10.4: Cost of Equity	205
Table 10.5: Summary of the Valuation of WMC	207
Table 10.6: Summary of the Valuation of Klipspruit	210
Table 10.7: Summary of the Valuation of Khutala	213
Table 10.8: Comparable Market Transactions	215
Table 10.9: Traded Market Multiples of Comparable Coal Companies	216
Table 10.10: Summary of SAEC NPV per Reserve multiple	217
Table 10.11: Summary Valuation of SAEC's Mining Asset Coal Reserves on 100 per cent terms	218
Table 10.12: Assigned Value of the defined Coal Reserves on 100 per cent terms	219

Figures

Figure 2.1: Location of SAEC's South African Mineral interests as at 31 December 2014	2
Figure 2.2: Total Current Coal Reserve Annual Coal Sales for WMC, Klipspruit and Khutala	27
Figure 4.1: Energy Coal Cash Cost Curve (FOB) – (USD/t, 2013)	39
Figure 4.2: Holding structure of SAEC	39
Figure 4.3: Administrative structure of SAEC	40
Figure 4.4: SAEC's Optimised Base Plan – Total ROM tonnes	41
Figure 4.5: Location of SAEC's current operations, Development Projects and Exploration areas	43
Figure 4.6: Location of the Karoo Basin in South Africa	51
Figure 4.7: Karoo Basin Cross Section	52
Figure 4.8: Location of the Karoo Basin and South African Coalfields	53
Figure 5.1: Overview of the Wolvekrans-Middelburg Complex	67
Figure 5.2: Current and Previous Mining Areas at the Wolvekrans Mine	68
Figure 5.3: Current and Previous Mining Areas at the Middelburg Mine	69
Figure 5.4: Typical stratigraphy of the Witbank Coalfield	71

Figure 5.5: Distribution and thickness of prominent sandstone channel at Wolvekrans – legend shows interburden thickness between No.2 Seam and No.2A Seam in metres	72
Figure 5.6: Selective underground mining of the No.2 Seam at Wolvekrans	73
Figure 5.7: Main structural features in BMK East area	74
Figure 5.8: East west cross-section through BMK East	75
Figure 5.9: Cross-section through Steenkoolspruit pit	75
Figure 5.10: Devolatilisation of No.2 Seam by dolerite sill at Klipfontein pit	76
Figure 5.11: Cross-section through Hartbeestfontein pit showing rolling seams	77
Figure 5.12: Borehole distribution at Wolvekrans	78
Figure 5.13: Borehole distribution at Middelburg	80
Figure 5.14: Wolvekrans Mine Cladding Process	90
Figure 5.15: Wolvekrans Mine Pillar Coal (No.2P) Percentage	91
Figure 5.16: Wolvekrans LOA Production Breakdown	93
Figure 5.17: Middelburg Production Breakdown	94
Figure 5.18: BCP Material Movements	96
Figure 5.19: BCP Logistics System Flow Diagram	97
Figure 5.20: Wolvekrans Historical and Forecast Manning	105
Figure 5.21: Middelburg Historical and Forecast Manning	106
Figure 5.22: Wolvekrans Mine Safety Performance	107
Figure 5.23: Middelburg Mine Safety Performance	108
Figure 5.24: Rail infrastructure linkages from SAEC's operations to RBCT	110
Figure 5.25: SAEC's saleable plan to fill TFR allocation	111
Figure 5.26: TFR Rail Performance	112
Figure 5.27: Total area disturbed and Land rehabilitated vs land disturbed at WMC	114
Figure 5.28: Proposed expenditure on rehabilitation at WMC (ZAR M per annum)	115
Figure 5.29: Real cash costs over Life of Coal Reserves	117
Figure 5.30: Capital expenditure profile of WMC	118
Figure 5.31: Klipspruit Mining Rights and Surface Rights	121
Figure 5.32: North-south cross-section through Klipspruit	123
Figure 5.33: Borehole distribution at Klipspruit	124
Figure 5.34: Plan showing the current and planned operations	129
Figure 5.35: Klipspruit - Historical and forecast production	131
Figure 5.36: Klipspruit Production Breakdown	132
Figure 5.37: Phola CHPP Block Flow Diagram	134
Figure 5.38: Klipspruit - Employee numbers	136
Figure 5.39: Klipspruit safety performance	137
Figure 5.40: Total area disturbed and Land Rehabilitated vs Land Disturbed at Klipspruit	139

Figure 5.41: Proposed expenditure on rehabilitation at Klipspruit (ZAR M per annum)	140
Figure 5.42: Klipspruit cash costs (real)	142
Figure 5.43: Mining areas and associated wetland areas within the Khutala Mine	146
Figure 5.44: Main geological structure features at Khutala	148
Figure 5.45: Cross-sections through Khutala showing the effect of palaeo-highs	149
Figure 5.46: Borehole distribution at Khutala	150
Figure 5.47: Progress plan of No.4 Seam	159
Figure 5.48: Progress plan of No.2 Seam	159
Figure 5.49: Khutala production schedule - historical and forecast	160
Figure 5.50: Employee historical and current numbers	161
Figure 5.51: Safety statistics	162
Figure 5.52: Total area disturbed and land rehabilitated vs annual disturbance at Khutala	164
Figure 5.53: Proposed expenditure on rehabilitation at Khutala (ZAR M per annum)	165
Figure 5.54: Khutala cash operating costs	166
Figure 5.55: Location of proposed Khutala life extension project (2019 to 2043)	170
Figure 5.56: Forecast ROM coal production from No.2, No.4 and No.5 Seams	171
Figure 6.1: Summary of ownership and tenure for Weltevreden	173
Figure 6.2: Weltevreden borehole plan	174
Figure 6.3: Weltevreden cross-section	175
Figure 6.4: Plan showing proposed LOA mining pits	176
Figure 6.5: Forecast ROM Production Schedule for LOA Plan	177
Figure 6.6: Forecast Export Saleable Coal Production for LOA Plan	177
Figure 6.7: Forecast ROM Production Schedule for "Go forward" Case	178
Figure 6.8: Forecast Export Saleable Coal Production for "Go forward" Case	179
Figure 6.9: Plan showing wetland areas and classification	180
Figure 6.10: Summary of ownership and tenure for Leandra	182
Figure 6.11: Cross-section through Leandra Project	183
Figure 6.12: Leandra (North and South) Coal Resource footprint	184
Figure 6.13: Summary of Naudesbank tenure showing resource footprint and wetland buffer	187
Figure 6.14: Cross Section through the Naudesbank Project	188
Figure 8.1: SAEC coal supply markets	193
Figure 8.2: Thermal Coal Price forecasts (nominal)	194
Figure 9.1: Adjacent companies to SAEC's Mining and Development Assets	198
Figure 10.1: Wolvekrans-Middelburg sales tonnes (Scenario 3)	206
Figure 10.2: WMC cash flow (Scenario 3)	207
Figure 10.3: NPV sensitivity of WMC	208
Figure 10.4: Klipspruit export tonnes	209

Figure 10.5: Klipspruit cash flow	210
Figure 10.6: NPV sensitivity of Klipspruit	211
Figure 10.7: Production and sales profile of Khutala Mine	212
Figure 10.8: Khutala cash flow	213

Appendices

Appendix A: SAEC's BEE Audit Certificate
Appendix B: Schedule of Mineral and Surface Rights
Appendix C: Environmental Authorisation Status
Appendix D: CESR Compliance Checklist

Key abbreviations

°	Degrees of angle
°C	Degrees Celsius
ABI (YGP)	Abrasive Index (Yancey, Geer and Price)
adb	Air-dried basis
AIG	Australian Institute of Geoscientists
AMD	Acid Mine Drainage
amsl	Above mean sea level
Anglo Inyosi	Anglo American Inyosi Coal (Pty) Ltd, a subsidiary company of Anglo American Plc
Ash%	Ash Content
ASIC	Australian Securities and Investment Commission
ASX	Australian Securities Exchange
AUD	Australian dollars
AusIMM	Australasian Institute of Mining and Metallurgy
B-BBEE	Broad-based black economic empowerment
BCM	Bank Cubic Metre
BCP	SAEC Coal Processing, an operating unit of SAEC
BEE	Black Economic Empowerment
BECSA	BHP Billiton Energy Coal South Africa Pty Ltd. For the purposes of this report, known as South Africa Energy Coal (SAEC) to signify the potential demerger from BHP Billiton.
Benchmark product	The primary thermal coal product targeting 6,000 kcal/kg (NAR).
BHP Billiton	BHP Billiton Plc and/or BHP Billiton Limited
BHPB SA	BHP Billiton SA Holdings Limited
Billiton	Billiton Plc, a predecessor company to BHP Billiton
Bn	Billion(s)
BP	British Petroleum

CESR	The Committee of European Securities Regulators
CIMVAL	The Canadian 2003 Edition of the Standards and Guidelines for Valuation of Mineral Properties
Coal Assets	A collective term meaning all the Mining Assets, Development Assets and Exploration Assets
Coal Guidelines	South African Guide to the systematic evaluation of coal resources and coal reserves, South African National Standard SANS 10320:2004
Company	South Africa Energy Coal
CP	Chartered Professional, designation of the AusIMM
CPR	Competent Persons Report
CV	Raw Calorific Value expressed in Mega Joules per kilogram
DAFV%	Dry, ash-free volatile content
DCF	Discounted cash flow
Development Assets	A collective term comprising all SAEC's material development projects, namely Klipspruit Extension, Leandra North, Leandra South and Naudesbank.
DMO	Douglas Middelburg Optimisation
DMR	South African Department of Mineral Resources
DTM	Digital Terrain Model
DWS	South African Department of Water and Sanitation (previously the Department of Water Affairs)
EMP	Environmental Management Plan
EMPr	Environmental Management Plan report
Eskom	Electricity Supply Commission of South Africa
ESMA	European Securities and Market Authority
ESOP	Employee Share Ownership Programme
Exploration Assets	A collective term comprising SAEC's exploration projects, namely Waterberg, Union, Pegasus and Witbank South.
FCA	Financial Conduct Authority
Fm	Formation, as in geological formation
FMV	Fair market value
FTE	Full time equivalent
Gencor	Gencor Limited
GHG	Green house gas
Gp	Group, as in geological group, stratigraphic grouping
GTIS	Gross Tonnes In-situ
ha	Hectare
HGI	Hargrove Grindability Index
ICC	Ingwe Coal Corporation Limited, a predecessor company to Ingwe and SAEC
IM%	Inherent Moisture
Ingwe	Ingwe Collieries Limited, a predecessor company to SAEC
IP	Intellectual property
IPS	Identification Phase Study

IWULA	Integrated Water Use Licence Application
IWWMP	Integrated Water and Waste Management Plan
JORC Code	The 2012 Edition of the Australasian Code for Reporting of Exploration Results, Mineral Resources and Ore Reserves
JSE	Johannesburg Stock Exchange
JV	Joint Venture
kcal/kg	Kilocalories per kilogram of coal, a measure of energy content
KPSX	Klipspruit Extension, which incorporates the techno-economic studies associated with the Weltevreden Coal Resource and Klipspruit South areas
kt	Thousand tonnes
Kuyasa Mining	Kuyasa Mining (Pty) Limited, a BEE mining company
LED	Local Economic Development
LOA	Life-of-Asset
LOM	Life-of-Mine
LOW	Limit of weathering described as depth from topography surface
LSE	London Stock Exchange
M	Million(s)
m	Metres
m ³	Cubic metre(s)
Ma	Million years ago
MA	Mining Area
MCCM	Mine Closure Closed Mines, a business unit within SAEC
MDEDET	Mpumalanga Department of Economic Development, Environment and Tourism
Mining Assets	A collective term for SAEC's material mining assets, namely the Wolvekrans-Middelburg Complex, Klipspruit and Khutala
MJ/kg	Megajoules per kilogram, a unit expressing energy content
mm	Millimetre(s)
Mm ³	Million cubic metres
MPRDA	South African Mineral and Petroleum Resources Development Act (Act 28 of 2002)
Mt	Million metric tonnes
Mtpa	Million metric tonnes per annum
MW	Megawatts
NAR	Net as received basis
NEMA	South African National Environmental Management Act (Act 107 of 1998)
NEMLA	South African National Environmental Laws Amendment Act (Act 25 of 2014)
South32	South32 Limited, the new entity to be demerged from BHP Billiton
NGO	Non-governmental organisation
NOMR	New Order Mining Right
NOPR	New Order Prospecting Right
NPV	Net present value
NWA	South African National Water Act (Act 36 of 1998)
Ptn	Portion

Rand Barlow	Rand Barlow Group
RBCT	Richards Bay Coal Terminal
RBRL	Richards Bay Rail Line
RD	Relative density
RE	Remaining Extent
RoD	Record of Decision
ROM	Run-of-Mine
RPO	Recognised Professional Organisations
SAEC	South Africa Energy Coal
SAIMM	South African Institute of Mining and Metallurgy
SAMREC Code	The 2009 Edition of the South African Code for the Reporting of Exploration Results, Mineral Resources and Mineral Reserves
SAMVAL	The South African Code for the Reporting of Mineral Asset Valuation
SANAS	South African National Accreditation System
SAPS	South African Police Service
Shell	Royal Dutch Shell Plc
SLP	Social and Labour Plan
Strip ratio	Ratio of mining waste in bank cubic metres to the coal tonnes mined
t	Tonne(s)
Tavistock	Tavistock Collieries (Pty) Ltd, an affiliated company of Xstrata South Africa (Pty) Ltd
TCM	Total cubic metres
TFR	Transnet Freight Rail, the State owned rail authority
TS%	Raw Total Sulphur Content
UKLA	United Kingdom Listing Authority
USD	United States Dollars
VALMIN Code	The 2005 edition of the Code for the Technical Assessment and Valuation of Mineral and Petroleum Assets and Securities for Independent Expert Reports
VDD	Vandyksdrift, an area within the Wolvekrans Mine
VM%	Volatile Matter content
WitCol	Witbank Mine Limited, a predecessor to RandCoal
WMC	Wolvekrans-Middelburg Complex
WUL	Water Use Licence
WULA	Water Use Licence Application
Xstract	Xstract Mining Consultants Pty Ltd
Xstrata	Xstrata South Africa (Pty) Ltd, a subsidiary of Glencore Plc
ZAR	South African Rand

1 Covering letter

Please refer to the covering letter at the beginning of this document.

2 Executive summary

The directors of South32 Limited ("South32"), have commissioned Xstract Mining Consultants Pty Ltd ("Xstract") to prepare a Competent Persons Report on the coal assets of South Africa Energy Coal ("SAEC" or "the Company"), currently held within BHP Billiton Energy Coal South Africa Pty Ltd ("BECSA").

It is understood that SAEC is to be demerged from BHP Billiton, along with certain other aluminium, coal, manganese, nickel and silver assets, into a new corporate entity, South32. Simultaneously, South32 will seek a listing on the Australian Securities Exchange, the Johannesburg Stock Exchange, and on the Official List of the United Kingdom Listing Authority, in order to trade on the Main Board of the London Stock Exchange.

This report provides a technical account of SAEC's Mining, Development and Exploration Assets. It compiles currently available and material information to assist potential investors in South32 make a reasoned judgement regarding the techno-economic merits of SAEC's Assets. The focus of this report is on the technical aspects of these assets: including tenure, geology, Coal Resource and Coal Reserve statements, mine plans, production rates, infrastructure, environment and social, capital and operating cost estimates, and principal risks, opportunities and uncertainties. It includes a valuation of SAEC's currently defined Coal Reserves.

This report has been prepared by Competent Persons in accordance to the 2012 Australasian Code for Reporting of Exploration Results, Mineral Resources and Ore Reserves ("JORC Code") and 2005 Code for the Technical Assessment and Valuation of Mineral Assets and Securities in Independent Expert Reports ("VALMIN Code") to comply with the rules and requirements of the European Securities and Markets Authority's Recommendations on consistent implementation of Commission Regulation ("EC") No. 809/2004 implementing the Prospectus Directive (the "ESMA Recommendations").

This Competent Persons Report is dated 11 March 2015, with an effective date of 31 December 2014. All monetary values outlined in this report are expressed in United States Dollars ("USD") or South African Rands ("ZAR"), unless otherwise stated.

This report assesses the Coal Assets from SAEC's perspective, not that of BHP Billiton.

2.1 SAEC

SAEC is a Johannesburg based subsidiary company of BHP Billiton. Following a recent empowerment transaction, SAEC is now 90 per cent owned by BHP Billiton, with the residual interest held by a BEE consortium (8 per cent) and SAEC employees (2 per cent). SAEC's principal activities include exploration, development and operation of coal mines and coal processing facilities, which produce energy coal products for the South African domestic and export markets.

SAEC's assets comprise a significant land package mainly located near the towns of Witbank (eMalahleni) and Middelburg in the coalfields of Mpumalanga and Gauteng Provinces, South Africa (Figure 2.1). Further Exploration Assets are held in the Limpopo and Kwazulu Natal Provinces.

Figure 2.1: Location of SAEC's South African Mineral interests as at 31 December 2014

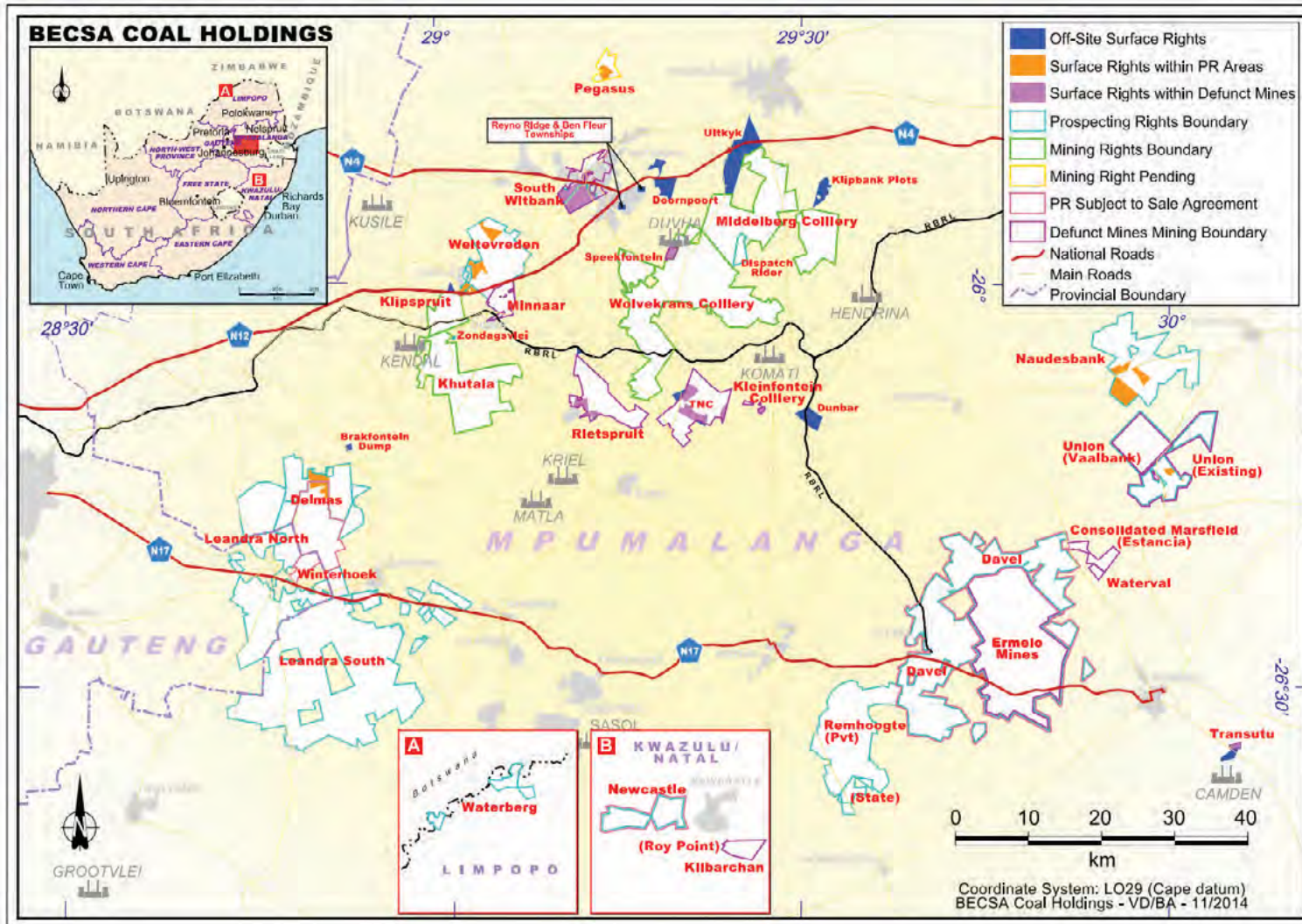

Source: SAEC

SAEC's Material Coal Assets are summarised in Table 2.1 and form the basis for this Competent Persons Report. Whilst Xstrat acknowledge SAEC holds additional mineral interests over and above those outlined in Table 2.1, these are not considered material for the purposes of this report.

Table 2.1: Summary of SAEC's Material Assets as at 31 December 2014

Asset	No. of Farms	Status	New Order Licence	Area (ha)	SAEC's interest	Resource (2012 JORC)	Reserve (2012 JORC)
Mining Assets							
Wolvekrans	15	Operating mine	Mining	15,101.97	100%	M+I+I	P+P
Middelburg	14	Operating mine	Mining	18,938.06	100%	M+Inf	Prv
Klipspruit	5	Operating mine	Mining	2,165.31	100%	M+Inf	Prv
Khutala	6	Operating mine	Mining	9,321.15	100%	M	Prv
Development Assets							
Klipspruit Extension	8	Pre-development	Prospecting	7,327.72	100%	M+I+I	-
Leandra	39	Pre-development	Prospecting	45,618.54	100%	M+I+I	-
Naudesbank	7	Adv. Exploration	Prospecting	9,132.71	100%	M+I+I	-

P+P = Proved and Probable Reserves, Prv = Proved Reserves, M+I+I = Measured, Indicated and Inferred Resources, M+Inf = Measured and Inferred Resources, M = Measured Resources, Ind = Indicated Resources, Inf = Inferred Resources.

Production from the Wolvekrans-Middelburg Complex ("WMC") is reliant on SAEC Coal Processing ("BCP") comprising five coal beneficiation plants; North Export, North Middlings, South Eskom, South Export and VDD mobile crusher, which are wholly owned and operated by SAEC. In addition, the Klipspruit operation is supported by the Phola coal handling and preparation plant, which is held under a 50:50 feed to plant joint venture with Anglo Inyosi Coal (Pty) Ltd ("Anglo Inyosi") (Table 2.2).

Khutala is a run-of-mine ("ROM") facility, which includes a destoning process through a Bradford breaker with the coal then conveyed to a ROM stacker reclaimer stockpile operated by Eskom.

Table 2.2: SAEC Coal Processing Capacity

Mining Asset	Processing Plant	SAEC's interest	Current Processing Capacity (Mtpa)	Process flow sheet
Wolvekrans - Middelburg	North Plant (Export and Middlings)	100%	8.0 Mtpa	CHPP
			7.2 Mtpa	CHPP
	South Eskom (Destoning Plant)		4.9 Mtpa	CHPP
	South Export		14.0 Mtpa	CHPP
	Vandykesdrift Dump		1.2 Mtpa	CHPP
Klipspruit	Phola	50%	16 Mtpa	CHPP
Khutala		100%	18 Mtpa	ROM & Destoning

Source: SAEC

SAEC is also legally responsible for various closed coal mines, which are the subject of ongoing mine closure activities. To this end, SAEC has established a dedicated mine closure – closed mines team.

2.2 Geological setting

SAEC's coal mining and development projects predominantly target the Witbank Coalfield of Mpumalanga Province. Of secondary importance are the Ermelo and Highveld Coalfields.

These coalfields have a long history of production with mining focussed on the coal-bearing units of the Vryheid Formation of the Ecca Group (early-Permian) within the late-Carboniferous to middle-Jurassic Karoo Basin of Southern Africa.

Typically, five bituminous coal seams are recognised and are numbered from No.1 Seam at the base to No.5 Seam at the top of the coal-bearing sequence. The coal seams are generally flat to gently dipping and may be subject to floor rolls in places depending on the nature of underlying basement geology. Major seams, particularly No.4 Seam and No.2 Seam, usually split into "upper" and "lower" components and vary in their economic importance across the different operations and development assets.

Igneous intrusions in the form of dolerite dykes and sills are common and affect the coal seams to varying extents depending on locality. Where sills transgress coal seams, the strata overlying the sill is uplifted in elevation by an amount approximately equivalent to the thickness of the sill, resulting in some complex structural configurations.

The Khutala operation is bisected by a major east-west striking graben structure. Elsewhere, faulting is generally uncommon with throws usually less than 3 m. These faults are usually associated with dolerite sill transgressions and with the flanks of basement palaeo-high features.

2.3 Coal Resources and Coal Reserves

Table 2.3 shows a high level summary of SAEC's Coal Resources and Coal Reserves as at 30 June 2014 on 100 per cent terms. Refer to Section 4.6 for further details of SAEC's stated Resources and Reserves. All Coal Resources outlined are inclusive of Coal Reserves unless stated otherwise. Table 2.4 summarises the Marketable Reserve tonnages on a product split basis.

Table 2.3: SAEC's Coal Resources and Coal Reserves as at 30 June 2014 (adb) on 100 per cent terms

Asset	Coal Resources			Coal Reserves			
	Category	In-situ (Mt)	Ash (%)	Category	ROM (Mt)	Marketable (Mt)	Ash (%)
Mining Assets							
Wolvekrans (OC)	Measured	496	25.9	Proved	389	273	21.8
	Indicated	18	30.0	Probable	17	12	22.5
	Inferred	118	30.2				
	Total	632	26.8	Total	406	285	21.8
Middelburg (OC)	Measured	211	28.0	Proved	97	80	23.2
	Indicated	-	-	Probable	-	-	-
	Inferred	7.3	24.7				
	Total	218	27.9	Total	97	80	23.2
Klipspruit (OC)	Measured	138	27.6	Proved	43	36	23.0
	Indicated	-	-	Probable	-	-	-
	Inferred	1.1	29.8				
	Total	139	27.6	Total	43	36	23.0
Khutala (OC & UG)	Measured	1,331	31.8	Proved	37	34	33.7
	Indicated	-	-	Probable	-	-	-
	Inferred	-	-				
	Total	1,331	31.8	Total	37	34	33.7
Development Assets							
Weltevreden	Measured	192	29.2				
	Indicated	212	31.1				
	Inferred	143	30.6				
	Total	547	30.3				
Leandra North	Measured	210	27.7				
	Indicated	194	27.3				
	Inferred	103	27.0				
	Total	507	27.4				
Leandra South	Measured	10.5	28.1				
	Indicated	132	27.1				
	Inferred	938	26.0				
	Total	1,080	26.2				
Naudesbank	Measured	103	25.4				
	Indicated	132	24.9				
	Inferred	54	25.3				
	Total	289	25.2				

Source: BHB Billiton Annual Report 2014

Note: T Project, Rem Block IV and Davel assets have been divested, or are being divested, and are not reported here.

Table 2.4: Summary of Marketable Reserve product split (adb), as at 30 June 2014

ROM/Product	WMC (Mt)	Klipspruit (Mt)	Khutala (Mt)	Total (Mt)
ROM	503	43	37	583
Benchmark	167	18	-	185
4,800 kcal/kg	34	18	-	52
Domestic	164	-	34	198

Source: SAEC

The thickness and coal quality cut-offs applied in the Coal Resource and Coal Reserve estimates are based on practical technical assumptions derived from the consideration of historical mining activities, as outlined in Table 2.5.

Table 2.5: Key thickness and raw coal quality assumptions supporting the Coal Resources and Coal Reserve estimates

Deposit	Coal Resources	Coal Reserves
WMC	≥1.0 m seam thickness, ≤45% ash, ≥17.9% volatile matter	≥1.0 m seam thickness, ≤45% ash, ≥17.9% volatile matter, ≥2,870 kcal/kg
Khutala	≥1.0 m seam thickness for OC, ≥2.5 m seam thickness for UG, ≤45% ash, ≥24.0% dry ash-free volatile matter	≥1.0 m seam thickness for OC, ≥3.6 m seam thickness for UG
Klipspruit	≥1.0 m seam thickness for OC, ≤45% ash, ≥24.0% dry ash-free volatile matter	≥1.0 m seam thickness, ≤45% ash, varying ≥3,580 kcal/kg to 4,300 kcal/kg
Weltevreden	≥0.8 m seam thickness for OC, ≤45% ash	-
Leandra North	≥1.8 m seam thickness	-
Leandra South	≥1.8 m seam thickness	-
Naudesbank	Varying ≥0.5 m to 0.8 m seam thickness, ≤45% ash, ≥22.0% dry ash-free volatile matter	-

Source: BHB Billiton Annual Report 2014

2.4 Mining asset overview

Within the Witbank Coalfield, SAEC has its granted Mining Rights grouped together into three Projects, namely the Wolvekrans-Middelburg Complex, the Klipspruit Mine and the Khutala Mine as summarised in Table 2.6.

2.4.1 Wolvekrans-Middelburg Complex

The WMC is an opencast bituminous coal mining and processing operation situated in the Witbank Coalfield. The complex is split into three main operating entities, namely the Wolvekrans Mine, Middelburg Mine and SAEC Coal Processing ("BCP"). The mines are divided into nine main sections, with mining at both consisting of opencast operations with coal extracted by dragline and truck and shovel at a peak combined production rate of approximately 26.4 Mtpa ROM coal.

BCP operations comprise five coal beneficiation plants, North Export, North Middlings, South Eskom, South Export and VDD mobile crusher. Total coal beneficiation processes approximately 21 Mtpa ROM coal and 6 Mtpa of dump material across the mine complex.

Wolvekrans

Mining is carried out at Wolvekrans via open cut mining methods. Wolvekrans is a result of the merger of five different collieries and mining commenced in its current configuration in 2010.

The mining method is one used regularly throughout the open cut coal industry, comprising a mix of dragline and truck/shovel. The mining areas are divided into pits of varying shapes and the pit configurations are based on economics and other drivers, such as surface infrastructure and environmental constraints.

Those pits with longer strike lengths incorporate draglines in the coal exposure process, while shorter and odd shaped pits are mined by truck and shovel only. This is a common coal mining practice throughout the coal mining industry and is considered very low risk.

There is a complexity at Wolvekrans that adds a high degree of operational risk, but one that is not uncommon in other South African coal mining operations. The No.5, No.4, No.2 and No.1 Seams throughout much of the mining area have been previously mined as part of historical underground operations by a bord and pillar method. The remainder of these seams are now being mined as part of the open cut operations. There is significant overlap between the areas that have been previously mined by underground methods and the planned open cut mining areas. Mining of remnant pillars is becoming more common and solutions are being developed to reduce the risks of spontaneous combustion, improved recovery of the coal and water management from previously flooded underground mining areas.

Table 2.6: Overview of SAEC's Mining Assets

Mine and Location	Means of Access	Ownership	Title	History	Mine type	Mine Life (Years)	Facilities, use and condition
Wolvekrans – Middelburg 20 km southeast of Witbank, Mpumalanga Province, South Africa	Public Road Export coal transported to RBCT by third party rail (558 km) Domestic coal transported by conveyor to Duvha Power Station	SAEC 100% Previous JV (84:16) with Tavistock was amended in February 2008	SAEC and Tavistock are joint holders of three Mining Rights in JV ratio (84:16). SAEC holds 100 per cent interest in fourth Mining Right. All four rights comprise the WMC. ⁽¹⁾ Mining Rights granted during Oct and Dec 2011. ⁽²⁾	Production commenced in 1982. Middelburg and Duvha Colliery became one operation in 1995. Douglas Middelburg Optimisation project completed in July 2010. Mine split into Middelburg and Wolvekrans during 2011.	Opencast Produces a medium rank bituminous thermal coal, most of which can be beneficiated for European or Asian markets.	<u>Wolvekrans</u> 21 years 14.5 Mtpa ⁽³⁾ <u>Middelburg</u> 23 years 6.6 Mtpa ⁽³⁾	Beneficiation facilities: tips and crushing plants, 2 export wash plants, middlings wash plant, de-stone plant. Nominal capacity in excess of 17 Mtpa.
Klipspruit 30 km west of Witbank, Mpumalanga Province, South Africa	Public Road Export coal transported to RBCT by third party rail (611 km)	SAEC 100%	SAEC holds a Converted Mining Right granted on 11 Oct 2011.	Production commenced 2003. Expansion project completed FY2010, includes 50% share in Phola Coal Plant	Opencast Produces a medium rank bituminous thermal coal, most of which can be beneficiated for the export market.	6 years 6.9 Mtpa ⁽³⁾	Beneficiation facilities: tips and crushing plant, export wash plant. Nominal capacity Phola Coal Processing Plant in excess of 7 Mtpa.
Khutala 100 km east of Johannesburg, Gauteng Province, South Africa	Public Road Domestic coal transported by overland conveyor to Kendal Power Station	SAEC 100%	SAEC holds 100% interest in Converted Mining Right, granted Oct 2011. Mining Right amended 15 Feb 2013 to include Portion 16 of Zondagsvlei 9 IS.	Production commenced in 1984. Open cut operations in 1996. Commenced mining thermal coal for domestic market in 2003.	Combination opencast and underground Produces a medium rank bituminous thermal coal (non-coking).	5.8 years 5.9 Mtpa ⁽³⁾	Underground and open-cut crushers; Nominal capacity in excess of 12 Mtpa.

1. This includes the Wolvekrans and Middelburg Mines and excludes the portion Tavistock obtained as a result of the amendment of the Douglas-Tavistock JV agreement.
2. The JV agreement has been amended so that upon the Department of Mineral Resources amending the Mining Rights, the mining area will be divided into an area wholly owned and operated by Tavistock and an area wholly owned and operated by SAEC as the new Douglas-Middelburg mine. Applications were made in December 2008 to the Department of Mineral Resources to amend the Mining Rights, but a date for execution has not yet been provided. Ministerial consent to amend the Mining Rights has been granted.
3. Long-term average production rate of ROM Coal

Strip ratios at Wolvekrans are around 4.5 bcm/t ROM, which is slightly elevated for a thermal coal deposit. The current production rate at Wolvekrans is approximately 14.5 Mtpa of ROM coal. SAEC's proposed LOA plan for Wolvekrans shows a continual and gradual increase in annual coal production until the peak at 28.8 Mt in FY30. Following this peak, annual coal production continually declines until the end of mine life during FY39. The growth in coal production from 14.3 Mt in FY12, to 28.8 Mt in FY30 represents a doubling in production. However, this is over a period of 18 years and so represents an achievable rate of increase, through productivity improvements, extra fleets of equipment and an increased use of contractor. As with annual coal production, the total excavation gradually increases each year and peaks in FY31. The total excavation in FY31 of 130 total cubic metres ("TCM") represents a 135 per cent increase over the FY12 annual volume excavation of 55 TCM.

The current mine plan includes 71.5 Mt in material which is yet to be classified as a Coal Reserve. This material resides in the Albion Section and part of the Vandyksdrift South Section at Wolvekrans. The bulk of this is resides in two satellite pits within the current Mining Right on the farms Vandyksdrift and Albion in the southern part of the operation. Further drilling is required to upgrade this Resource to Measured and Indicated status before conversion to Reserves. However, the coal is not scheduled in the LOA plan until 2024, which provides SAEC with a considerable length of time to upgrade these Coal Resources to Reserve status.

The current mine plan includes a fleet of three draglines, 2,700 t shovels, front-end loaders and large off-road haul trucks. With the increase in the production forecast, there is a requirement to significantly increase the size of the truck and shovel fleet as reflected in the capital expenditure over the next 10 years.

Middelburg

Mining is carried out at Middelburg Mine via open cut mining methods comprising a mix of dragline and/or truck/shovel. The mining areas are divided into pits of varying shapes and the pit configurations. There is no mining of remnant underground pillars in the Middelburg operations.

The Middelburg pits are typically very shallow so the dragline can excavate the necessary depth to uncover coal. There is generally no need for truck and shovel operations to pre-strip waste above the dragline horizon. Where any pre-strip may be required, it is carried out by contract operations.

Conversely to Wolvekrans and the planned doubling of production there, the Middelburg Mine is forecast to peak within the five year plan timeframe, before gradually decreasing. Currently Middelburg mine produces around 5.5 Mt of ROM per annum. There is a slight increase in annual coal production at Middelburg until the peak at 6.5 Mt in FY18. Following this peak, the coal production declines to a range around 4 Mtpa for a period of eight years, before then gradually declining until the end of mine life in FY38. Strip ratios, which is the ratio of mining waste to the coal mined, at Middelburg is around 5 bcm/t ROM of coal, which is considered to be slightly elevated for a thermal coal deposit. Given historical coal production rates have been in the vicinity of 6 Mtpa, future coal production should be easily achievable.

The current mine plan includes two draglines, with a fleet of front-end loaders and large off-road haul trucks for coal mining. The mine also operates with a fleet of truck and shovel equipment owned and operated by contractors. As the pit size diminishes the mine will eventually become totally operated by contractors using truck and shovel operations, once the strip length is no longer viable for the use of the one dragline.

There is about 7 Mt of coal in the current LOA plan at Middelburg which is classified as an Inferred Coal Resource. There is an opportunity to convert this material to a Coal Reserve through improving confidence in the Resource following additional drilling over the forthcoming years.

The principal products from the Complex are power station grade coal for Eskom's nearby Duvha power station and higher quality export grade products for the seaborne thermal coal markets. Export coal is transported by rail to the RBCT, while coal for the nearby Duhva Power Station is delivered by conveyor belt.

2.4.2 Klipspruit

Klipspruit is an opencast bituminous coal mining and processing operation located in the Ogies district of Mpumalanga Province. The operation comprises the Klipspruit Mine and a 50 per cent interest in the nearby Phola Coal Processing Plant.

The mine is divided into the Smaldeel (Main Pit), Bankfontein North (Mini Pit) and Klipspruit South working sections and is a multi-seam operation with coal extracted by dragline and truck and shovel for crushing, screening and washing at the Phola Coal Plant. Annual capacity is approximately 7.2 Mt of saleable coal. The principal products from Klipspruit are export quality products for the seaborne thermal coal markets. Coal is transported to Richards Bay for export.

The Klipspruit Mine is a single dragline, multi-seam opencast operation in the Main Pit, combined with a truck shovel Mini Pit operation. The dragline method employed ranges from a single bench to double bench method. Opencast mining uses a series of strips and cuts over a wide area, where the surface is relatively flat and the coal seams comparatively shallow. The stripcut initially started as a boxcut, which was then advanced to a 3 km strip cut with 40 m wide ramps being moved at around 50 m strip cuts and placed as space became available in the low wall.

The Klipspruit Mine has consistently mined around 8.5 Mtpa of ROM coal for the export market since commencing operations in 2009. The Main Pit has a strike length of approximately 3 km and an average strip ratio of between 2.3 and 3.2 bcm/t ROM over the next six years. The target production from the Main Pit operation is around 7 Mtpa and 1.2 Mtpa from the Mini Pit. Historical figures from Klipspruit are relatively consistent and support production estimates going forward.

There is currently one dragline at Klipspruit which is supported by a coaling fleet of front end loaders and off-road haul trucks.

SAEC intends to seek an amendment to its existing Klipspruit Mining Right, which was originally granted with the Klipspruit South area as an underground mining operation. The amendment seeks to change mining of the Klipspruit South area (with Coal Resources of 73 Mt) to opencast strip mining methods.

In addition to the current Klipspruit mining operation, SAEC is currently conducting a pre-feasibility study into the opencast mining potential of the Weltevreden Coal Resources, also referred to as the Klipspruit Extension ("KPSX"). This area lies in close proximity to the existing Klipspruit operations and hosts Coal Resources totaling approximately 547 Mt. Conversion to Coal Reserves for an initial "go forward" case is expected to provide for an extension to the Klipspruit LOA for a further 20 years, with additional pits to be considered in the future. This increased production capacity enables Klipspruit to maintain its current production profile and retain the current employment opportunities at the Mine. As part of its proposed amendment, SAEC also seeks to extend the existing Klipspruit Mining Right to include the contiguous Weltevreden Prospecting Rights.

2.4.3 Khutala

Khutala is an underground and opencast coal mining operation located immediately adjacent and south of SAEC's Klipspruit Mine. The operation is wholly owned and operated by SAEC, with production from the No.2 and No.4 Seams tied to Eskom's Kendal Power Station. The No.5 Seam, mined by open cast, is blended with thermal coal from Klipspruit.

The mine is predominantly an underground bord and pillar mining operation with small open pit operations, which is planned to be completed around December 2014. Beneficiation facilities consist of a crushing plant for the energy coal with a combined nominal capacity of in excess of 12 Mtpa. A separate smaller crusher and wash plant with a nominal capacity of 1.5 Mtpa is used to beneficiate the coal supplied from the opencast operation. Coal from the No.2 and No.4 Seams is transported via overland conveyor to the Kendal Power Station.

The underground mine is accessed by a large diameter vertical shaft for men and materials and there is an access decline which is used to transport the coal on a conveyor from underground to the surface stockpiles. In total there are currently 12 working areas (known as sections), with eight sections in the No.2 Seam and four sections in the No.4 Seam. The current underground mining method is to use modern mechanised continuous miners in all working sections. Both the No.2 and No.4 Seams are mined using continuous miners, mechanised roof bolters, electric shuttle cars and feeder breakers. The broken coal is loaded onto a network of conveyor belts, which transport the coal to surface.

In both the No.2 and No.4 Seams, faults and dykes are included in the mining plan in order to determine areas likely to be affected with areas classified as either Good, Moderate and Bad. Relevant modifying factors are then applied to estimate the likely production rate for each area.

Over the near term, underground production is forecast to reduce from the current 7.5 Mtpa to around 3 Mtpa, as Khutala becomes constrained by a lack of defined underground reserves. The underground reserves are estimated to be exhausted by FY19 (No.4 Seam) and FY20 (No.2 Seam).

The Khutala mine was originally designed as an open cast mine, however due to the unavailability of mining equipment during the sanction era in South Africa the design was changed to an underground mine.

Due to the extraction methodology (bord and pillar, which involves a high degree of sterilisation) the Khutala Coal Reserve has been depleted at a higher rate that it would have as an opencast operation. In addition, as underground mining progresses the coal seam is becoming significantly shallower and future extraction of coal will have to occur via opencast methods, as it will soon become unsafe to mine underground as such shallow depths. The Khutala Mine therefore needs to be recapitalised in order to re-establish the operation as an opencast mine.

For various reasons, the recapitalisation has not yet occurred, and as a result, the opencast has not been commissioned timeously to replace diminishing underground Coal Reserves and hence a supply gap has emerged. At current extraction rates, the Khutala underground Coal Reserves are forecast to be depleted within six years.

In order to prolong the Khutala mine life, SAEC and Eskom are now jointly evaluating the Khutala life extension project (formerly known as Kipanya), which represents the progressive transition from underground to opencast mining of the remaining Coal Resources located:

1. to the east of the known palaeo-high present within the Khutala Mining Right, and

2. around the defunct Kendal underground room and pillar mine, in the north of the Khutala Mining Right (refer to Figure 5.55).

Having carried out Selection Phase Studies (“SPS”) in 2013 and 2014, which detail the planned mining and costings for the Khutala life extension project resource base, it is SAEC’s intent to complete further studies in order to convert the defined Coal Resources to Coal Reserves in the near term. These current Coal Resources equate to approximately 416 Mt gross tonnes in-situ (“GTIS”) of which 346 Mt ROM is classed as mining inventory for the mine taking into account geological losses and practical mining thickness cut-offs have been applied (greater than 1 m seam thickness, less than 45 per cent ash and a calorific value exceeding 15 MJ/kg).

2.5 Development assets

SAEC’s Development Assets comprise projects considered key to SAEC’s future initiatives to replace diminishing reserves at its Mining Assets. As such, these projects have been the subject of sufficient study to define Coal Resources that are capable of being developed (Table 2.7).

Table 2.7: Status of SAEC’s Development Assets

Project	Level of Study	Coal Resources (near to medium term development)
Klipspruit Extension	In Pre-feasibility	Measured, Indicated and Inferred Coal Resource
Leandra North	Concept level	Measured, Indicated and Inferred Coal Resource
Leandra South	Concept level	Measured, Indicated and Inferred Coal Resource
Naudesbank	Concept level	Measured, Indicated and Inferred Coal Resource

Source: Xstract

2.5.1 Klipspruit Extension

The Klipspruit Coal Reserves are expected to be exhausted in FY20. SAEC is currently investigating the Klipspruit Extension (“KPSX”), which encompasses the Weltevreden Coal Resource area and the Klipspruit South area. Mining of KPSX would allow an extension to Klipspruit’s mine life of approximately 50 years.

The Weltevreden Coal Resource area comprises three wholly owned Prospecting Rights situated contiguous with SAEC’s Klipspruit Mine and in relative proximity to Eskom’s Kendal Power Station and the Phola JV plant.

A Section 102 amendment has been lodged with the DMR to amend the Klipspruit Colliery Mining Right to include the three Weltevreden Prospecting Right areas. Successful inclusion of the Weltevreden Prospecting Rights into the Klipspruit Colliery Mining Right will mitigated any perceived risk involving loss of tenure associated with the Prospecting Rights.

Although the Weltevreden Coal Resource area has not been mined before, it is considered a greenfields development option to the current Klipspruit mining activities.

While the Weltevreden Coal Resource area may be viewed as an extension to Klipspruit Mine, the currently defined Coal Resources are separated by a basement palaeo-high. Furthermore, the Weltevreden Coal Resource contains thinner coal seams than at Klipspruit Mine, albeit the seams possess reasonable export product potential.

SAEC is currently evaluating the “go forward” case under the ongoing pre-feasibility study. Under the KPSX studies, the Weltevreden Prospecting Rights area contains sufficient Coal

Resources to allow an initial “go forward” extension to Klipspruit’s mine life of at least 20 years. Mine plans are yet to be developed and confirmed, but the LOA is expected to be approximately 50 years.

While all five seams are present, the defined Coal Resource is mostly concentrated in three seams that are all in excess of two metres thick, namely the No.4L, No.2 and No.2A Seams (77 per cent of the total Coal Resource). The high ash characteristic of the No.2 Seam is due mainly to the presence of in-seam partings.

Having carried out initial technical studies in 2013 and 2014, it is SAEC’s intent to complete further studies in order to convert the defined Coal Resources to Coal Reserves in the near term. SAEC has prioritised a preferred “go forward” case, which comprises the development of the B and D pits within the Weltevreden Coal Resource area.

Upon development, the “go forward” case is expected to be mined at a rate of 10 Mtpa ROM coal for at least the first 20 years. Opencast strip mining is currently SAEC’s preferred mining method. Feasible options for strip mining comprise either truck and shovel methods, or the use of a dragline.

Under current plans, the ROM coal will be transported from the opencast pit to a buffer stockpile before being transported to the Phola Plant at Klipspruit Mine. The saleable production is forecast to be approximately 7 Mtpa.

Certain areas of the currently identified pits may require adjustments as a consequence of further evaluation of environmental factors related to drainage courses and wetlands.

2.5.2 Leandra Project

SAEC’s wholly owned Leandra Project resides to the west of SAEC’s Mining Assets in proximity to the small towns of Devon and Leslie/Leandra and the Transnet Rail line with links to Richard’s Bay. It comprises five Prospecting Rights of which three have been renewed for a further three-year term.

The presently defined Leandra Coal Resources are located in the northwest of the Highveld Coalfield and adjacent to the former Delmas Mine. Drilling has identified the No.5, No.4UA, No.4U, No.4L, No.3, No.2 and No.1 Seams. No.4L Seam and the lower portion of the No.2 Seam, known as the Select portion (No.2S), are the two main underground targets at Leandra. The coal seams are significantly affected by intrusive dykes and sills.

The Leandra Coal Resources are contained in the No.4L and No.2S Seams. With 80 per cent of the resource reporting to the Measured and Indicated categories at Leandra North, this resource is relatively mature from an exploration perspective. In comparison, the Leandra South Project is immature, with 87 per cent of the total tonnage assigned to the Inferred category.

The coal resource has been evaluated for extraction by underground mining methods (non-caving bord and pillar) and is primarily suited for the domestic thermal coal market supplying either power generation or petro-chemical markets, with limited potential for superior washed products.

No significant mining technical studies have been completed for the Leandra North or Leandra South Projects. Depths of the two seams considered for mining (No.2S and No.4L Seams) are at 140 m and 108 m below surface respectively in Leandra North and 201 m and 157 m below surface respectively at Leandra South. Depth and geological structure suggest that underground mining using a bord and pillar mining method is the most appropriate for coal extraction.

2.5.3 Naudesbank Project

SAEC's wholly owned Naudesbank Project comprises a single Prospecting Right, which is currently awaiting renewal for a further three year period. Located to the east of SAEC's Mining Assets and near the town of Carolina, the project lies towards the northern limit of the Ermelo Coalfield. The coal seams in the Ermelo Coalfield are typically thinner than those in the Witbank Coalfield.

Five coal seams are recorded and are named from the dominant E Seam at the base to the A Seam at the top of the coal-bearing succession. The A Seam further splits into the A Upper ("AU") and A Lower ("AL") Seams, while the C Seam splits into the C upper ("CU"), C Middle ("CM") and C Lower ("CL") Seams.

On a seam basis, the Naudesbank Coal Resources are dominated by the thicker and more laterally continuous E Seam (52 per cent of the total Resource) which could provide potential for underground mining. The stated Coal Resources assume an opencast mining scenario for the deposit with in-situ strip ratios generally in the range of 7:1 to 10:1 bcm/t. These are exacerbated if either; seams of less than 0.8 m in thickness are excluded (currently 0.5 m), or the CM Seam is excluded due to its high inherent ash content.

Beneficiation characteristics of coal seams at the Naudesbank Project demonstrate the ability to produce an export coal product of approximately 6,400 kcal/kg (adb).

Although there has been some preliminary work conducted regarding potential mining scenarios, further studies are required before any decision can be made to develop the Naudesbank Project.

2.6 Exploration assets

In addition to the Mining and Development Assets, SAEC holds a number of other exploration assets in the Witbank, Highveld, Ermelo and Waterberg Coalfields. Xstract does not consider these regional exploration assets to be material in terms of the overall value assigned to SAEC, however they are important as they provide further growth options going forward and hence are summarised briefly here for completeness.

These exploration assets are either: (i) small and isolated coals unlikely to be of sufficient scale to attract further investment from SAEC in the near term, (ii) located in close proximity to formal settlements and hence may prove difficult to obtain the necessary approvals for development and/or (iii) did not meet the criteria for the classification of Mineral Resources according to the JORC Code.

As such, these assets are considered to represent long-term options, which are not currently planned or expected to be further tested or developed in a period of less than five years (Table 2.8).

Table 2.8: Status of SAEC's Exploration Assets

Project	Level of Study	Comment (medium to longer term development)
Union	Advanced Exploration*	Renewal required for Prospecting Rights located south of Naudesbank with potential for similar coals.
Pegasus	Advanced Exploration*	Mining Permit application offering potential for a small, but isolated coal deposit
Witbank South	Advanced Exploration*	Conversion required of Prospecting Right over former colliery, proximity to township a potential issue
Waterberg	Advanced Exploration*	Prospecting Right with potential for sizeable coal deposit, at a distance to SAEC's other assets.

Source: Xstract

*based on the definition of Advanced Exploration Areas in VALMIN Code (2005).

2.7 Infrastructure

SAEC holds a well-established suite of mining operations that are accessed via an established, sealed road network. Power and water to the operations are via contracts with Eskom and local government agencies. SAEC has an internal and external rail network system that firstly allows coal to be moved from operations to the relevant CHPP facility required to process that quality coal and secondly for the final product to be moved to the domestic (power stations) or international market via the RBCT.

Power supply to the various mining operations total 25,500 MWH per month with 56.6 MVA maximum demand usage with Power Factor Control and 60.6 MVA without Power Factor Control. Total notified demand for all operations facilities is 75.2 MVA.

BCP's processing facilities at WMC have a dedicated power supply to support processing operations with 22,200 MWH per month, 28 MVA maximum demand usage with power factor control and a 35 MVA maximum demand usage without power factor control. There is also a 35 MVA notified maximum demand.

The Phola processing plant has a dedicated power supply to support processing operations with 3,900 MWH per month, 7.5 MVA maximum demand usage and 8 MVA notified maximum demand.

Potable water to the various operations is supplied by Eskom (43 ML) and Phola Plant (2 ML), for a total of 45 ML each month. All process water is sourced from pollution control dams with a combined capacity of 1,830 ML. All operations have potable water supply contracts with Eskom.

BCP has an internal rail system that allows ROM coal transfer between the North and South Plant sites. The rail system has a maximum ROM/raw coal transfer capacity of 4 Mtpa in either direction.

The Northern Plant train loadout stockyard can store approximately 80,000 t of export coal as live capacity (4,800 kcal/kg product and a benchmark⁹ primary product) and can stack out an additional 80,000 t of export coal as dead/emergency capacity that requires dozer recovery.

The Southern export plant has 150,000 t of live stockpile capacity.

⁹ See Glossary

Reclaimed coal from the North and South Plants enters the export train load-out silo, which has a capacity of 9,000 t. As they are separate stockpiles, and feed the silo from separate conveyors, the north and south stockpiles can feed the silo at the same time. Each train has a capacity of 8,400 t and is loaded on average in four hours.

In its review of rail constraints, SAEC recommended that coal stocks fall no lower than 60,000 t and that a target stock level of 170,000 t is maintained. It has also recommended that total export stockpile capacity be increased to 300,000 t.

BCP is currently investigating the expansion of the Northern train load-out stockpiles to 160,000 t of live capacity through modification of the portal reclaimer to allow it to reclaim from the emergency stockpile.

Product coal from the VDD CHPP is sold to Eskom or to the export market. Export coal is stored in silos and loaded onto trains via a refurbished train loadout system. Currently two trains a week are loaded from the VDD system with an average 4-hour turnaround.

SAEC has access to the Transnet Freight Rail ("TFR") system with a 10-year contract in place for coal haulage through to RBCT to 2026.

A major focus of SAEC's FY15 five-year plan is the train system and ensuring minimal train cancellations initiated by SAEC. A key part of this plan is to improve internal logistical coal flow by:

- Identifying minimum and target export stock levels
- Removing internal transportation bottlenecks
- Taking advantage of internal available transportation capacity (i.e. internal rail)
- Increasing live export stockpile capacity.

SAEC owns a 21 per cent interest in Richards Bay Coal Terminal ("RBCT"), which provides for a proportionate (i.e. 21 per cent) port allocation on an annual basis. RBCT currently has a capacity of 91 Mt annually. SAEC therefore has theoretical access to a maximum of 19.9 Mt of coal capacity annually. However, the throughput rate is capped due to the rail capacity of 81 Mtpa and this entitles SAEC to a throughput rate of 17.3 Mtpa to RBCT, which will remain unchanged at a different shareholding unless SAEC take up additional shares.

2.8 Environment

Introduction

SAEC holds the relevant environmental authorisations and is legally permitted to conduct mining activities at WMC, Klipspruit and Khutala, having submitted the Environmental Management Programme reports ("EMPr") required in terms of the MPRDA and Water Use Licences ("WUL") required in terms of NWA.

Thus, SAEC's mines generally have environmental permissions and authorisations to conduct operations in the current manner. Furthermore, there is unlikely to be any major risk of the authorities restricting/ceasing current operations due to legal compliance issues. As is common in all operations of this size, there are a few licensing issues to attend to in order to ensure that the mines remain legally compliant.

A primary risk with regard to environmental authorisations for expansion projects, such as the proposed Weltevredend Project and Khutala life extension Project, is the time required to obtain new authorisations from the relevant authorities. SAEC's Competent Person reports note that once certainty is established with regard to the technical viability of a proposed mining project, it typically takes three years to obtain all relevant authorisations.

Environmental authorisations are on the critical path for all proposed operations and pose the risk of delays.

Community and social

SAEC has numerous community development initiatives, which are considered to be successful. Initiatives include Local Economic Development ("LED") projects, which aim to promote community enrichment and diversification of the local economy into a sustainable form in preparation for a post-mining future. SAEC's LED projects align with the legal commitments in each mine's Social and Labour Plans ("SLP").

Social development projects will be required, an example being at KPSX where mining will occur adjacent to the Phola informal settlement.

Closure and rehabilitation

Rehabilitation of surfaces disturbed by mining is required at all the opencast areas. There remains a backlog of rehabilitation requiring completion at WMC and Klipspruit, which:

- From a financial perspective, the rehabilitation liability is now higher than it would have been had the rehabilitation been completed on schedule.
- From a legal standpoint, SAEC's EMPR's committed the mines to rehabilitate 80 per cent of the area disturbed each year.
- From a water perspective, un-rehabilitated land increases the water inflow of the mines, which in turn can increase water management costs.
- Funds may need to be spent on rehabilitation of these areas more timeously than currently budgeted should authorities require the Company to do so.

SAEC's mines currently determine its closure costs in two ways. The first is using a format determined by the DMR for legal compliance, while the second is an internal SAEC estimate for the likely costs of closure.

SAEC and the DMR are in agreement with the quantum of liability in terms of the DMR method of calculation (ZAR3,560,282,456), and SAEC is largely funded for this liability (ZAR3,435,692,695) by means of trust funds and bank guarantees.

SAEC recognises that the DMR calculation does not account for all eventualities (especially with regards to water liability). As such, SAEC has prepared an internal estimate of the overall liability (ZAR6,280,000,000), which is appropriately recognised in SAEC's financial statements. Xstract commends SAEC on this initiative.

Xstract notes there is draft legislation under review, which may require mining companies to provide additional monies for added water liabilities not currently included in the DMR calculation methodology. Should this legislation be approved, mining companies may have a shortfall requiring them to increase their liability provisions and potentially causing a short-term cash deficit of material magnitude.

SAEC has made provisions in its financial accounts for anticipated new legislation, which may require currently operating mines to provide for their water treatment and management liabilities.

In addition to the mining operations, SAEC manages sixteen closed mines under the guidance of the Mine Closure Closed Mines unit. This rehabilitation unit is responsible for the environmental management of the SAEC's defunct operations, based in Mpumalanga and Kwa-Zulu Natal. The following defunct operations are noted in Table 2.9.

Table 2.9: Summary of SAEC Mine Closure Closed Mines (excluding Douglas)

Mine	Areas Managed and Leased (Ha)	Disturbed (Ha)	Rehabilitated (Ha)	Undisturbed (Ha)
BLOEMENDAL	10.14	3	0	7.14
ERMELO	3218.45	16	103	3162.45
ESTANCIA (Consolidated Marshfield))	625	0	7	
GARDINIA	120	0	120	
HAASFONTEIN	6	0	6	
ROY POINT	755.83	408.51	0	
KLEINFONTEIN	151.57	0	35	
DELMARE- LEANDRA	2690	0	0	
KANGWANE ANTHRACITE	1.5	1.5	0	
MINNAAR	232	66.44	7	
WITBANK COLLIERY	1741	692	50	
TNC	1985.72	92	421	
UNION	1523.51	343	85.2	
REITSPRUIT	3667.62	99.18	1095.33	
SPEEKFONTEIN	184.84	82	60	

Source: SAEC

A provision of ZAR1.962 Bn is in place for defunct and derelict mines and forms part of the total closure provision included in BHP Billiton's audited financial statements (Annual Report 2014). This provision is calculated as the discounted net present value of the full liabilities for all the defunct and derelict mines. It is important to note that this provision will be transferred with SAEC to South32.

In the overall valuation of SAEC this provision is largely offset by a trust fund of ZAR1.681 Bn. Importantly this report values the currently defined coal Reserves and as such this provision for closed and defunct mines does not affect the valuation outlined in this report.

Water issues

Future mining in the north of the WMC requires the effective removal of water from previously mined areas. Given the time taken to obtain various environmental authorisations, dewatering of this area is now on the critical path for successful implementation of the mining plans. Dewatering is occurring and enhanced evaporation is used to reduce water volumes in this area. A desalination plant is under construction to enable water treatment and discharge so that future workings can be accessed.

Acid mine drainage resulting from long term decant is expected at SAEC's WMC, Klipspruit and Khutala Mines due to increased water ingress following mining, and in particular

open pit mining. This contaminated water represents a long-term liability, which will need to be treated to comply with catchment objectives.

SAEC's financial model has assumed a long-term water treatment method using trees to reduce water ingress/decant, and the use of semi-passive treatment systems based on biological means. Xstract support this approach but there is a risk that this is not sufficiently effective to preclude mechanical water treatment options. As such, Xstract recommends the inclusion of mechanical water treatment options in the financial model. For its valuation, Xstract has included provision for capital and operating costs associated with mechanical water treatment options. SAEC's proposed closure approach remains to be approved by the authorities. The currently approved EMPr's at Middelburg and Klipspruit include mechanical decant water treatment options.

Wetlands

An emerging issue for the South African coal mining industry is the extension of the current buffer zone around wetland areas. SAEC has various development areas, which will require active management of these issues. There is potential for extended timelines to approvals or authorisations to projects involving wetland areas, as extensive negotiation are likely to be required with government authorities. This is particularly relevant to the proposed KPSX, as well as for expansion plans at WMC.

2.9 Costs

2.9.1 Capital

The total capital requirement USD1,649 M (excluding capitalised closure costs) for SAEC's Coal Assets is summarised in Table 2.10. These costs are associated with both sustaining and project development capital. Project capital of USD575 M is allocated to the Wolvekrans Mine mostly for the development of the Vandyksdrift area (refer to section 5.2 of the main document). The balance is all sustaining capital on WMC, Klipspruit and Khutala Mines.

Table 2.10: SAEC – Capital Cost estimate (real)

Mine	Item (USD M)	FY15 H2	FY16	FY17	FY18	FY19	FY20- beyond
WMC	Project	5.5	23.3	56.1	132.8	228.1	130.7
	Sustaining	29.0	159.1	155.0	46.8	63.0	469.3
	Closure	15.0	18.3				40.0
Klipspruit	Sustaining	3.0	7.9	5.8			
	Closure						1.3
Khutala	Sustaining	18.2	19.3	16.1	16.8	10.3	11.4
	Closure						1.6
Total		70.7	227.9	233.0	196.4	301.4	654.3

Source: SAEC, Xstract estimate

2.9.2 Operating

The total operating costs for SAEC's Coal Assets are summarised in Table 2.11, Table 2.12, and Table 2.13.

Mining operating costs include waste removal and coal mining for both WMC and Klipspruit. While at Khutala, mining costs include underground development, coal mining and handling.

Processing costs at WMC and Klipspruit include coal handling, crushing, screening and washing. The unit cost of USD5.44/t product at WMC is higher than at Klipspruit of USD3.29/t product due to a higher yield of 83 per cent at Klipspruit relative to 75 per cent at WMC. No processing takes place at Khutala.

The total General and Administration cost include both site and SAEC's corporate office.

Rail and port unit cost for WMC is a low USD7.62/t product compared to USD13.28/t product for Klipspruit as only 60 per cent of WMC coal is exported, while all of Klipspruit's coal is exported.

Table 2.11: SAEC (WMC) – Operating Cost estimate (real)

Unit Cost (USD/t Product)	FY15 H2	FY16	FY17	FY18	FY19	FY20-38 average
Mining	19.06	16.70	16.22	16.17	15.88	21.43
Processing	4.99	4.84	4.56	4.88	4.55	6.16
General and Administration	7.06	10.98	10.42	9.89	9.82	10.40
Rail and Port	6.43	6.40	6.90	6.86	7.08	8.32
Marketing and others (incl. Royalty)	0.54	0.54	0.58	0.58	0.60	1.06
Total	38.03	39.45	38.68	38.38	37.93	47.36

Source: SAEC, Xstract estimate

Table 2.12: SAEC (Klipspruit) – Operating Cost estimate (real)

Unit Cost (USD/t Product)	FY15 H2	FY16	FY17	FY18	FY19	FY20
Mining	11.75	11.94	13.48	12.43	11.39	10.85
Processing	2.99	2.80	3.40	3.04	3.58	4.08
General and Administration	2.10	8.35	9.52	9.38	10.10	10.84
Rail and Port	13.51	13.25	13.25	13.25	13.25	13.25
Marketing and others (incl. Royalty)	4.61	3.85	3.85	4.23	4.40	4.41
Total	34.97	40.18	43.50	42.33	42.73	43.44

Source: SAEC, Xstract estimate

Table 2.13: SAEC (Khutala) – Operating Cost estimate (real)

Unit Cost (USD/t Product)	FY15 H2	FY16	FY17	FY18	FY19	FY20
Mining	16.52	16.34	16.33	17.24	17.10	21.18
Rehabilitation	0.02	0.02	-	-	1.99	2.98
General and Administration	9.31	12.06	12.45	12.91	14.34	22.49
Reimbursement of sustaining capital	5.02	2.79	2.38	2.73	2.16	2.34
Total	30.87	31.21	31.16	32.88	35.59	48.99

Source: SAEC, Xstract estimate

2.10 Market analysis

In addition to its domestic thermal and metallurgical coal markets, South Africa is also a significant swing producer to both the Atlantic and Pacific seaborne thermal coal markets. South African coals are generally low in sulphur but high in ash. Beneficiation is essential for export-quality coal. Lower-quality coal is primarily used for the local power generation market.

As the country's principal electricity generator and supplier, approximately 90 per cent of Eskom's electricity is sourced from coal-fired power stations, using some 125 Mt of coal annually (or approximately 49 per cent of domestic coal production). Eskom requirements are forecast to reach 140 Mt over the next five years and 150 Mt by 2022.

The synthetic fuels, chemicals and local industrial sectors consume a further 20 per cent of South Africa's annual coal production.

Coal exports are equivalent to about 32 per cent of South African output and are mainly destined for Pacific markets but also Europe. Given planned improvements in infrastructure, exports are forecast to increase from 82 Mt in 2013 to 91 Mt in 2018.

There has been an excess of thermal coal supply in many regions of the world recently resulting in a significant fall in coal prices since 2012. The global oversupply is expected to peak in 2017, with a modest recovery in price ensuing.

2.11 Risks and opportunities

2.11.1 Risks

General project risks

SAEC's portfolio of Mining and Development Assets are exposed to normal operational risks associated with mining, these being related to production, political and industrial disruption, as well as the economic factors such as currency fluctuation, interest rates and commodity prices. Profitability and asset values can be affected by unforeseen changes in operating circumstance and technical or economic issue. In addition to competent management, the success of the Development and Exploration Assets depends on the effectiveness of ongoing exploration and development programmes.

The successful operation and/or development of a mining operation are dependent upon geological interpretation to define mineable blocks and an appropriate schedule to meet expected sales volumes. Actual coal mined may be different in quality and tonnage than the estimates and the strip ratios and geological mining conditions anticipated may prove to be different. Operating costs can be adversely affected by disruptions due to geological conditions, equipment failure or industrial disputes. Development of a new mining operation is dependent upon the provision of rail for transport and port facilities for international shipping while an adequate supply of water is also important.

In respect of SAEC's Mining and Prospecting Rights, the various mineral rights are maintained in good order and the Company remains in compliance with various pieces of minerals, environmental and social related legislation. However, going forward SAEC requires the renewal/conversion of certain Mining and/or Prospecting Rights prior to mining or development. While SAEC has successfully obtained and maintained such rights previously, the envisaged production forecasts as outlined in this report is reliant on the continued maintenance of such rights and the successful conversion of additional Prospecting Rights to Mining Rights going forward. In particular, Xstract notes the pending renewal of SAEC's Prospecting Rights at Weltevreden, for which the Company has also

applied for integration of these rights into the Klipspruit Mining Right. The successful inclusion of these Prospecting Rights is integral to the Company's plans for Klipspruit. If unsuccessful, the Company will need to apply for the conversion of these Prospecting Rights to a new Mining Right, which will require the completion of various technical studies within a relatively short time frame (i.e. three years).

SAEC holds limited surface rights over certain mining areas, and as such, remains reliant on maintaining good relationships with other land-owners in order to access to its development and exploration project areas.

SAEC has two long-term contracts with Eskom. While these contracts provide a base demand for both the WMC and Khutala operations, some issues have arisen, including, but not limited to; (i) the requirement for Eskom to fund development capital and rehabilitation for Khutala, and (ii) contracted pricing at WMC are currently at rates below seaborne market prices. This has led to a situation at Khutala where the mine is undercapitalised and there is currently little incentive for either party to invest further in order to maintain required production rates as per the original contract. Eskom has lodged a claim against SAEC of "failure to supply its contracted coal tonnages" at Khutala Mine. The claim has been referred to arbitration for determination and is opposed by SAEC. This dispute is currently ongoing and as may present a significant financial liability to SAEC.

Media commentators and analysts have suggested the South African government is poised to announce iron and coal as "strategic minerals" in order to support local industrialisation. If implemented, such action has the potential to negatively impact on mining company profits going forward as coal would likely be sold at a "mine gate" price. Currently, over 50 per cent of SAEC's current production is sold at export prices and may be sensitive to the implementation of any such legislation.

Geology

Coal Resources prepared under the 2012 Edition of the JORC Code are best estimates based on individual judgement and reliance upon knowledge and experience using industry standards and the available database and models. In general, the risk to the Coal Resource under pinning the WMC, Klipspruit and Khutala mining operations is low from a resource confidence standpoint, as the coalfield has an extended coal mining history (over 100 years) and the geological structure, coal quality and depositional environment are well known and understood. However, there is some risk related to the environmental constraints on the Coal Resource in proximity to river courses and wetlands, which could materially discount the stated Coal Resource and/or Coal Reserve, if environmental approvals are not obtained timeously.

In general, the defined Coal Resources within SAEC's Development Assets have a lower geological confidence than those at the Company's Mining Assets given the lower density of drilling and lack of detailed technical studies. Conversion to Coal Reserves is dependent on further techno-economic studies being progressed and the proportion of currently defined Coal Resources likely to convert to Coal Reserves is uncertain.

Mining

The forecast development plans are predicated on SAEC achieving the planned production rates and product yields as indicated in this report. SAEC's LOA plans and associated valuation will need to be updated, if these planned production rates and product yields are not realised over time.

At Wolvekrans, production is forecast to double over the next 10 years. These forecasts are based on the Company achieving significantly higher productivity levels than has been

achieved historically, but below rates evidenced at other BHP Billiton-operated sites internationally, as well as other third party-owned operations in South Africa. As such, there is a risk that forecast efficiency gains may not be realised and that forecast production rates are lower than currently forecast. Achievement of the forecast rates will require active and on-going management. There are additional plans to increase the fleet size and capital will be required to improve production capacity.

The mining of remnant pillars involves inherent risks associated with the conversion of Coal Reserves and production. Stated Coal Reserves at Wolvekrans may need to be depleted due to spontaneous combustion in future, if the risk is not well managed.

On-going de-watering management of the underground workings may also affect production rates. While certain assumptions have been made in the Reserve model, loss and dilution of the coal may be higher than expected from the pillar extraction process, resulting in lower tonnages than currently forecast.

The current LOA plan includes a significant Inferred Resource component in VDDS and Albion areas. There is a small risk that these defined Inferred Resources do not readily convert to Coal Reserves as envisaged. Historically, SAEC's conversion rate has been relatively high.

Processing

SAEC's coal processing operations consist of industry standard equipment that has been used in coal operations worldwide for over 50 years. The coal plants at WMC and Phola are tried and tested designs, which do not give any major perceived risks to the continuity of the current operations. Potential risks going forward are that the plants are not actively maintained and as a result production rates are not achieved.

Key risks for the BCP facilities at WMC include: (i) as a result of on-going opencast mining through former underground workings, there may be an increase in tramp material, which could result in an increase in the rate and likelihood of conveyor belt damage, and (ii) the proliferation of cable and polyurethane pipe theft on the site.

At Phola, the joint venture partners have addressed key risks associated with the CHPP operations. For example, risks associated with (i) TFR train delays and the operation becoming stockpile bound have been mitigated through the expansion of product stockpiles, and (ii) the acquisition of additional reclaim capacity through feeder breakers should issues of availability occur with the existing product reclaimer system. Additionally, Phola has also progressively addressed issues associated with equipment availability in the CHPP.

Environmental

SAEC key risks relate to the LOA plan not being achieved to schedule due to environmental factors and permissions as well as pillar mining factors. These include:

- Obtaining environmental permissions and water use licences in the period available at Middelburg and Wolvekrans.
- the rehabilitation backlog at Klipspruit which will need to be addressed and expedited.
- At Klipspruit, a formal closure application and closure plan may be required in FY15, should the expansion project not proceed.
- Without the rehabilitation of the opencast pits and strict water control measures, the potential for AMD is significant Klipspruit.
- At Khutala, the highest potential risk is the uncertainty concerning the future of the mine and the likely timeline to obtain environmental authorisations for any expansion projects.

- At KPSX, granting of environmental authorisations to mine in proximity to existing wetlands/drainages may prove contentious and impact on SAEC's currently proposed development timelines.

2.11.2 Opportunities

Geology

Outside of South Africa, coal seams are commonly mined at thicknesses of less than 1 m, and have been mined as thin as 0.3 m in thickness. Xstract recommends that SAEC should actively investigate relaxing its applied thickness cut-off parameters to consider seams and selective mining at less than 1 m thick. For example at Middelburg, such a reduction (i.e. from 1 m to 0.6 m) results in a 5 per cent increase in the estimated Coal Resource tonnage.

Mining

Coal Reserves could be significantly increased through the conversion of the VDD and Albion Inferred Resources, which form part of the current LOA plan at Wolvekran. Further potential additions to Reserves within the near term include the conversion of the stated Measured and Indicated Resources at KPSX, as well as the Khutala Coal Resources to Reserves (Khutala life extension project).

Currently the operating efficiency of the truck and shovel operations are well below best practice and there is an opportunity for improvement, which will reduce operating costs and improve overall mine production. SAEC are reviewing the WMC operation to improve the mining method from dragline only to a mix of truck and shovel and draglines so as to enhance the coal production by improving coal exposed inventory. SAEC is currently planning to increase the truck and shovel fleet over the next 10 years. Xstract has in the valuation taken operational improvements into account.

There are opportunities to enhance the production at WMC through further investigations into mining coal below the current cut off thickness of 1 m. Throughout the world coal mining companies use a practical mining cut off of around 0.3 m coal thickness (depending on economics). SAEC are currently working on reviewing their cut off limits.

Processing

Currently the WMC plants are not working to capacity and there is an opportunity by increasing production from the mine to improve the overall efficiency of the plant. The plant is running at around 70 per cent of its full potential.

BCP availability, capacity bottleneck and high processing consumables issues under the control of SAEC are being investigated and addressed. As a result of these investigations, available hours will increase. As SAEC increases their utilisation of available hours processing costs on ZAR/ROM tonne basis will decrease.

As a result of an operating hours analysis, like BCP, the Phola CHPP has some latent processing capacity available for SAEC to exploit. However, this potential needs to be confirmed with a detailed review of past downtime, future mine production, coal allocation, and the effect of future coal quality on capacity (e.g. from KPSX).

Environmental

The Khutala Colliery is well-run from an environmental perspective, noting exceptional rehabilitation efforts and management of spontaneous combustion.

KPSX and Klipspruit South are planned appropriately and there is no reason a Mining Right should not be granted, provided adequate studies are completed.

Leandra is an underground operation and there are a number of third-party owned and operated mines surrounding these deposits. With prudent planning, there is no reason why there would be any major environmental or social impact effect on this project.

Brownfield expansions at existing operations are planned and will need to take into account particularly wetlands, the relocation of people where necessary and the short and long term water management issues. All items are well known to the SAEC environmental and operational personnel.

2.11.3 SWOT analysis

SAEC's key strengths, weaknesses, opportunities and threats are summarised in Table 2.14.

Table 2.14: Identified Strengths, Weaknesses, Opportunities and Threats to SAEC’s business

Strengths	Weaknesses
<ul style="list-style-type: none"> • Large resource base and optionality • Strong leadership team • Relatively flat real costs • Committed workforce • Well poised to take advantage of South Africa’s energy demand 	<ul style="list-style-type: none"> • Pit constraints – geometry, coal quality, remnant mining, and wet lands • Reliance on contractors for some core activities • Operating performance of truck and shovel operations • Variable performance of Eskom and TFR • Dragline strike length reduction overtime impacts productivities
Opportunities	Threats
<ul style="list-style-type: none"> • Brownfields “growth” options • Room for productivity and capacity improvements • Strengthening domestic prices with strong demand • Product mix optimisation and yield improvement • Reduce resource/reserve cut-off parameters to less than 1 m • Cost and headcount reductions • Ash-based selective mining 	<ul style="list-style-type: none"> • Wolvekrans ramp-up success • High exposure hours (Health and Safety) • Government and regulatory uncertainty • Environmental licences and pit-dewatering timeframes on critical path • Ability to secure assets – rising theft • Informal settlements close to operations • Pressure on logistic chain – BEE entry points on rail • Power supply

Source: SAEC, Xstract

2.12 Valuation

Income approach

SAEC compiled a financial model, which Xstrat has modified to incorporate changes to the LOA production schedule for each mine as required to support a valuation of the Coal Reserves only. Xstrat has considered three scenarios in its analysis of WMC:

1. Excluding Inferred Resource from VDD South and Albion. Keep supply commitment to Eskom. Reduced variable operating cost and capex accordingly. Export coal price based on the benchmark product with a 7 per cent discount to Newcastle pricing.
2. Original WMC production profile including Inferred Resource. Coal price based on the benchmark product with a 7 per cent discount to Newcastle pricing.
3. Excluding Inferred Resource from VDD South and Albion. Sales tonnes for Export and Eskom are reduced proportionally. Assumed Eskom sales will be made up by some other means. Have reduced variable operating cost and capex accordingly. Export coal price based on the benchmark product with a 7 per cent discount to Newcastle pricing.

Scenario 3 was used as the basis of Xstrat's DCF analysis for WMC as this was considered to be the most realistic case going forward.

The results of Xstrat's modifications to the LOA schedule are shown in Figure 2.2 and the resultant DCF analysis outputs summarised in Table 2.15. The table presents the Net Present Values ("NPV") of the post-tax pre-finance cash flows as determined from the financial model and include the variation in NPV with a range of real discount rates from 9 to 13 per cent.

Figure 2.2: Total Current Coal Reserve Annual Coal Sales for WMC, Klipspruit and Khutala



Source: Xstrat estimates

The NPV of WMC is significantly more sensitive to changes in economic input parameters than Klipspruit. On the other hand, Khutala is not affected by changes in economic input parameters. Revenue at Khutala is mainly based on cost reimbursement plus a return by way of an Eskom contract that takes nearly all of its production delivered to the Kendal power station.

Table 2.15: Summary - Value of SAEC Coal Reserves (100 per cent terms)

Discount Rate	Unit	WMC (Scenario 3)	Khutala	Klipspruit	SAEC
9% (real)	USD M	171.5	332.9	34.7	539.0
10% (real)	USD M	145.4	328.8	34.3	508.4
11% (real)	USD M	122.1	324.5	33.9	480.4
12% (real)	USD M	101.3	320.1	33.4	454.8
13% (real)	USD M	82.7	315.6	32.9	431.2

Source: Xstract estimates

The value assessed in Xstract's DCF analysis considers only the currently defined Coal Reserves as defined by SAEC. Xstract is also cognisant of the following:

- In addition to the scheduled Coal Reserves, there is an additional 7.9 Mt of Resources in the current mine plan. Given the requirement to value only Ore Reserves as part of this Competent Persons Report, these additional Resources were not valued.
- Optionality associated with the defined Mineral Resources outside of the current LOA mine plan. Specifically, WMC, Khutala and Klipspruit have an additional 345 Mt, 1,294 Mt and 96 Mt respectively as currently defined Coal Resources, which are not currently included in the mine plan
- The strategic location of SAEC's mining relative to other coal producers in the Witbank Coalfield along with its proximity to established transport infrastructure is likely to hold considerable appeal.
- Analysts suggest the recent market has been applying a discount to project NPV as measured by Price/Net Asset Value or NPV/share ratios. This suggests that analysts believe the market is not recognising and paying for project upside.

Market approach

In order to validate the values derived by DCF analysis, Xstract has considered recent transactions involving similar quality assets to those at SAEC. In doing so, Xstract has reviewed data provided by SNL and IntierraRMG. SNL and IntierraRMG provide databases of comparable transaction of coal projects and mines. Xstract selected eight transaction considered comparable that transpired between January 2010 to November 2014.

Analysis of the data for projects hosting Proved and Probable Reserves resulted in a range of normalised transaction values between USD0.04/t and USD6.11/t with an average of USD1.78/t.

In addition, Xstract considered trading multiples of listed coal mining companies of Enterprise Value per Marketable Reserve range between USD0.11/t to USD5.15/t.

For SAEC Operations, the implied value of Xstract's DCF analysis for WMC and Khutala lie within the range of its peer group, Klipspruit EV/t Reserve tonne multiple is significantly more. Xstract ascribes this to Klipspruit's high realised price and operating margin, as well as low capital expenditure requirement.

Table 2.16: Summary of SAEC NPV per Reserve multiple

SAEC mine	Marketable Reserves (Mt)	EV (USD M)	EV/Reserve (USD/t)
WMC	310.6	122.1	0.39
Klipspruit	32.4	324.5	10.03
Khutala	31.1	33.9	1.13

Source: Xstract estimates

Valuation summary

While the comparative transaction data supports the results derived from the DCF methodology, it is Xstract's opinion that the DCF modelling results provide a more conclusive indication of the current market value of SAEC's Coal Reserves.

Based on the calculations described elsewhere within this report, Xstract has assigned values for a 100 per cent interest in the defined Coal Reserves, as summarised in Table 2.17. These assigned values are the total intrinsic value of the respective assets and the values that would be attributable to SAEC.

Table 2.17: Assigned Value of the defined Coal Reserves on 100 per cent terms

Project	Low (USD M)	High (USD M)	Preferred (USD M)
WMC	101.3	145.4	122.1
Klipspruit	320.1	328.8	324.5
Khutala	33.4	34.3	33.9

Source: Xstract estimates

This valuation is reflective of SAEC's Coal Assets, based on our view in relation to Coal Reserves only. It is important to emphasise that this value does not represent the value of the Coal Reserves in the ground in isolation, but rather, incorporates the value of all of ungeared net assets contributing to the Asset based on a Coal Reserves production profile. For example, at SAEC's Mining Assets this includes the value of the use of processing facilities/truck fleet/rail loading facilities/rail entitlement/port infrastructure, as well as the mine.

3 Introduction

3.1 Background

Xstract has been commissioned by South32 to prepare a Competent Persons Report on the Coal Assets of SAEC.

SAEC is to be demerged from BHP Billiton, along with certain other aluminium, coal, manganese, nickel and silver assets, into a new corporate entity, South32. Simultaneously, South32 will seek a listing on the Australian Securities Exchange ("ASX"), the Johannesburg Stock Exchange ("JSE"), and on the Official List of the United Kingdom Listing Authority ("UKLA"), in order to trade on the Main Board of the London Stock Exchange ("LSE"), collectively referred to as the "Relevant Listing Authorities".

Xstract understands that this Competent Persons Report is to be included in its entirety in an ASX Information Memorandum, a JSE pre-listing statement and a UK prospectus, collectively referred to as the "Listing Documentation".

3.2 Review process

In preparing this Competent Persons Report, Xstract carried out the following scope of work:

- Introductory meeting with BHP Billiton's management and technical teams to understand the assets and associated production/development strategy and business plan
- Inspection visits to SAEC's mining and processing facilities, surface structures and associated infrastructure
- Discussion and enquiry following access to key project and corporate personnel between October and December 2014
- An examination of historical information and results made available by SAEC in respect of the technical aspects of the Coal Assets. Key elements reviewed included:
 - Geology reports and models, including geotechnical and hydrological aspects
 - Coal Resource and Coal Reserve estimates
 - Mining operations and proposed growth options
 - Coal preparation facilities
 - Coal handling and transport
 - Port operations
 - Environmental approvals and matters
 - Veracity of existing information supporting Life-of-Asset ("LOA") and business plans
 - Identification of key project drivers
 - Risks and opportunities
 - Valuation of Coal Reserves
- A review, and where considered appropriate by Xstract, modification of SAEC's production forecasts contained in the LOA plans.
- Preparation of a Competent Persons Report capable of supporting a listing on the ASX, JSE and LSE.

The technical information as provided to, and taken in good faith by, Xstract, has not been independently verified by Xstract by means of an independent re-estimation of the Coal Resource and Coal Reserve statements. Instead, Xstract's review focussed on the following:

- SAEC's Competent Person's Report for each asset was reviewed for compliance with the JORC Code (2012) and the reported totals cross referenced to the reported tonnages supporting the supplied financial model
- An independent financial model was compiled and validated with the model supplied by SAEC.
- Where fundamental base data was provided (LOA, capital expenditures, operating budgets, etc.), Xstract performed necessary verification procedures deemed appropriate in order to place an appropriate level of reliance on such information, in particular:
 - Assessments of drilling, sampling and quality assurance/quality control data, resource modelling, resource estimation, classification and reporting
 - Assessment and benchmarking of production assumptions, mining rate and production schedules against SAEC's historical production data supplied through

- management reporting and then matched against the physicals in SAEC's financial model
- Capital and operating costs were assessed against other comparable projects for reasonableness
- Material technical issues likely to impact on the LOA plan and the future performance of SAEC's assets were identified and evaluated.

Based on its review, Xstract has developed an in-house understanding of SAEC's assets. Xstract considers the technical information supplied to be appropriate for independent peer review and public reporting purposes.

3.2.1 Site visits

Xstract representatives visited SAEC's Coal Assets as summarised in Table 3.1.

Table 3.1: Summary of Xstract's site visits

Asset	Dates	Days	Xstract Representatives
JHB Corporate Office	20 & 24 Oct 14	2	I de Klerk, K Irving, R Marshall, G Trusler, B Thornton
Klipspruit Mine	21 Oct 14	0.5	I de Klerk, K Irving, R Marshall, G Trusler, B Thornton
KPSX Project	21 Oct 14	0.5	I de Klerk, K Irving, R Marshall, G Trusler, B Thornton
Khutala Mine/ Khutala life extension project	22 Oct 14	1	I de Klerk, K Irving, R Marshall, G Trusler, B Thornton
Wolvekrans Mine	23 Oct 14	0.5	I de Klerk, K Irving, R Marshall, G Trusler, B Thornton
Middelburg Mine	23 Oct 14	0.5	I de Klerk, K Irving, R Marshall, G Trusler, B Thornton

During these site visits, site infrastructure, workings and operations were inspected. These site visits substantiated the location and scale of SAEC's coal operations, which are supported by the development and production results detailed elsewhere in this report.

3.3 Structure

This Competent Persons Report has been structured on a technical discipline basis into sections on Geology, Coal Resources, Coal Reserves, Mining, Coal Processing, Equipment, Manning, Health and Safety, Infrastructure, Transportation, Marketing, Environmental, Social, and a Valuation of the Reserves within each of SAEC's Coal Assets.

The report is structured such that the Coal Assets are grouped by coalfield and development status. SAEC's Coal Assets are divided into the "Mining Assets", the "Development Assets" and the "Exploration Assets", as defined below:

- **Mining Assets:** Producing coal mines with a reserve life of at least five years.
- **Development Assets:** Coal assets for which at least Measured Resources have been declared and are essentially supported by a minimum level of multi-disciplinary study which demonstrates that development of the asset is technically feasible and economically viable in the near to medium term (i.e. less than five years)

- **Exploration Assets:** Coal assets for which JORC Code compliant Coal Resources may, or may not, have been declared, but for which additional work and/or studies are required to demonstrate technical feasibility and economic viability. Generally perceived as being unable to be brought into production rapidly (i.e. at least five years to development, if not longer).

The Mining Assets are discussed first followed by the Development Assets and the Exploration Assets. Xstract has focused its technical review in respect of the Mining Assets and Development Assets. All material projects and all projects for which JORC Code compliant Coal Reserves are publicly reported have been discussed in detail. Discussion and commentary in respect of the Exploration Assets is limited to general descriptive narrative as these Assets are considered largely immaterial.

Xstract notes that T Project, Davel and Remainder Block IV have either been divested, or are in the process of being divested, and hence are not considered further in this report.

3.4 Compliance

This Competent Persons Report has been prepared in accordance with the listing requirements of the Relevant Listing Authorities, namely:

- The ASX Listing Rules, in particular Chapter 5 and Guidance Note 31
- The JSE Listing Requirements, in particular Section 12
- The "Prospectus Rules" published by the Financial Conduct Authority ("FCA") and governed by the UKLA
- The "Prospectus Directive" (2003/71/EC) and "Prospectus Regulations" (809/2004)
- Sections 131 to 133 and Appendices I to II of the European Securities and Market Authority's ("ESMA") "Recommendations for the consistent implementation of Commission Regulation (EC) No 809/2004, implementing the Prospectus Directive" (the "ESMA Recommendations", as revised in March 2013).

This report has also been prepared in compliance with internationally accepted mineral reporting codes, these being:

- The 2012 Edition of the "Australasian Code for Reporting of Exploration Results, Mineral Resources and Ore Reserves" (the "JORC Code")
- The 2005 Edition of the "Code for the Technical Assessment and Valuation of Mineral and Petroleum Assets and Securities for Independent Expert Reports" (the "VALMIN Code")

In addition, this report recognises the 2009 Edition of "*The South African Code for the Reporting of Exploration Results, Mineral Resources and Mineral Reserves*" (the "SAMREC Code") and Edition 1 of the "*South African guide to the systematic evaluation of coal resources and coal reserves, South African National Standard SANS 10320:2004*" (the "Coal Guidelines").

Xstract specifically notes that SAEC's Coal Resources are reported as inclusive of Coal Reserves.

In line with the requirements of the VALMIN Code (2005), value is defined as 'fair market value' ("FMV"), being the amount for which a mineral asset should change hands between a willing buyer and a willing seller in an arm's length transaction where each party is assumed to have acted knowledgeably, prudently and without compulsion.

3.5 Data sources

In developing our assumptions for this report, Xstract has relied upon information provided by BHP Billiton, SAEC and information available in the public domain including:

- Various papers extracted from technical conference proceedings and Monographs of the Australasian Institute of Mining and Metallurgy ("AusIMM") and the South African Institute of Mining and Metallurgy ("SAIMM")
- Press releases, public announcements, media and analyst presentation material and other public filings, including information available on BHP Billiton's website
- Brokers' reports and recent press articles on BHP Billiton and other comparable companies, as well as the coal industry
- Share market data and related information on Australian and international listed companies engaged in the coal industry and on acquisitions of companies and businesses in this industry
- Information relating to the coal markets including forecasts regarding supply and demand, commodity price, inflation rates and exchange rates.

Key sources are outlined in this report and all data included in the preparation of this report has been detailed in the references section of this report. In the execution of its mandate, Xstract reviewed all relevant pertinent technical and corporate information made available by representatives of BHP Billiton and SAEC, which has been accepted in good faith as being true, accurate and complete, after having made due enquiry.

3.6 Competent Persons statement

Xstract's consultants involved in the preparation of this report are Competent Persons and Representative Experts as defined by the JORC and VALMIN Codes, respectively. They are also members of either the AusIMM, the Australian Institute of Geoscientists ("AIG") or other recognised Professional Organisations ("RPO"), for which compliance with the JORC and VALMIN Codes is mandatory. Xstract's Competent Persons involved in the preparation of this report are members in good standing with one or more of these professional institutions and have the required qualifications and experience as defined in the JORC and VALMIN codes to conduct this technical assessment and valuation.

Xstract's consultants are experienced in preparing competent persons, mineral specialist, independent geologist and valuation reports for mineral exploration and production companies. The authors of this report are qualified to express their professional opinions on the values of the mineral assets described.

3.7 Reliance statements

This report is dependent upon technical, financial and legal information.

Xstract understand from discussions with BHP Billiton that in parallel, but independent to this technical review, South32 has commissioned separate reviews of the corporate and legal aspects of SAEC. These reviews and their subject matter are not included in this Competent Persons Report as they were not available to Xstract at the time of writing.

3.7.1 Technical reliance

Xstract places reliance on SAEC that all technical information provided to Xstract as at 16 January 2015, is a fair and accurate account of the current status of the Coal Assets under review.

This report includes information on Coal Resources (inclusive of Coal Reserves) as reported by SAEC's Competent Persons: G Gemmell (SACNASP), J H Marais (GSSA) – Khutala; L Visser (SACNASP), J H Marais (GSSA) - Wolvekrans and Middelburg; P Maseko (SACNASP), J H Marais (GSSA) – Klipspruit; N Haniff (SACNASP), J H Marais (GSSA) - Leandra North, Naudesbank, Weltevreden and Leandra South; J H Marais (GSSA) - T-Project, Davel and Remainder Block IV, and Coal Reserves as reported by: I Thomson (SAIMM) - Khutala, Wolvekrans, Middelburg and Klipspruit. The information is extracted from the BHP Billiton Annual Report 2014, released on 25 September 2014, and can be found at www.bhpbilliton.com.

All the above mentioned Competent Persons are full-time employees of BHP Billiton at the time of reporting, unless otherwise stated, and have the required qualifications and experience to qualify as Competent Persons for Coal Resources under the 2012 Edition of the "Australasian Code for Reporting of Exploration Results, Mineral Resources and Ore Reserves" ("JORC Code"). The Competent Persons verify that the report is based on and fairly reflects the Coal Resources and Coal Reserves information in the supporting documentation and agree with the form and context of the information presented.

BHP Billiton confirms that it is not aware of any new information or data that materially affects the information included in the original market announcements and, in the case of estimates of Coal Resources and Coal Reserves, that all material assumptions and technical parameters underpinning the estimates in the relevant market announcements continue to apply and have not materially changed. BHP Billiton confirms that the form and context in which the Competent Persons' findings are presented have not been materially modified from the original market announcements.

Xstract's Competent Persons' responsible for the presentation of information and opinions expressed in this Competent Persons Report are:

- Jeames McKibben, MBA, BSc(Hons), MAusIMM(CP), MAIG, who is responsible for the valuation of SAEC's Coal Reserves and the overall preparation of this Competent Persons Report. Jeames is General Manager – Corporate Advisory with Xstract and has over 20 years' international experience in the mining industry. He is a current member of the VALMIN Review Committee and a Representative Expert as defined in the 2005 VALMIN Code;
- Ian de Klerk, MSc (Expl Geol), GradDipEng(Mining), MAusIMM, who has overall responsibility for the Coal Resources and geological aspects of this report. Ian is a Principal Consultant – Geology with Xstract and has over 24 years' coal experience. He is a Competent Person as defined in the JORC Code;
- Kevin Irving, MBA, BSc, FAusIMM(CP), FIMMM(CEng), MAICD, who has overall responsibility for the Coal Reserves and mine engineering aspects of this report. Kevin is General Manager - Mining with Xstract and has practised his profession as a mining engineer for over 35 years, predominantly in coal. He is a Competent Person as defined in the JORC Code;
- Richard Marshall MBA, BE (Minerals Process), MAusIMM(CP), who is responsible for the coal preparation and processing aspects of this report. Richard is a Principal Consultant with over 18 years' in coal processing. He is a Competent Person as defined in the JORC Code; and
- Graham Trusler, MSc(Eng), BComm, Registered Professional Engineer, MSAIChE, MWISA, MASMR, who has overall responsibility for the environmental and social aspects of this report. Graham is CEO and Consultant – Environment with Digby Wells and has over 21 years' experience as an environmental specialist to the mining industry. He is a Competent Person as defined in the JORC Code.

Jeames McKibben qualifies as a Representative Expert under the VALMIN Code and as a Competent Person under the JORC Code. He has supervised the preparation of this report and accepts overall responsibility for it under Section 37 of the VALMIN Code.

3.7.2 Financial reliance

In consideration of all financial aspects relating to the Coal Assets, Xstract has placed reliance on SAEC that the following information as they may relate to the Coal Assets and the Company, specifically the financial/accounting inputs to the Financial Models are appropriate as at 16 January 2015:

- Taxation aspects for all taxes including: opening balances; determination of tax-deductible items (depreciation); and summary of applicable taxes;
- Opening balances for debtors, creditors and stores and any associated working capital calculations as appropriate; and
- Other relevant financial aspects as would be required by potential investors in order to determine a technical valuation of SAEC's currently defined Coal Reserves.

The financial information referred to above has been prepared by SAEC.

3.7.3 Legal reliance

South32 has advised Xstract that it has commissioned other corporate and legal reviews pertaining to SAEC. Xstract understands that a detailed statement of all legal proceedings, which may have an influence on the rights to explore for or mine coal or an appropriate negative statement has been included in the body of the Listing Documents.

In regard to legal matters pertaining to SAEC's Coal Assets, Xstract refers readers to the Listing Documents, in particular statements under Risk Factors and Preparation of this Document sections.

As such, this Competent Persons Report specifically excludes all aspects of legal issues, land titles and commercial agreements, except such aspects as may directly influence technical, operational or cost issues. Xstract is not qualified to express legal opinion and has not sought any independent legal opinion on the ownership rights and obligations relating to the Coal Assets under licence or any other fiscal or legal agreements that BHP Billiton or SAEC may have with any third party in relation to the SAEC Coal Assets. Dispensation has been granted in this regard from inclusion in this report.

3.8 Independence, disclaimer and warranty

Xstract is a mining consultancy. Xstract was commissioned by South32 on a fee for service basis according to Xstract's standard schedule of rates. Xstract's fee is not contingent on the success of the demerger or any related transactions. Other than disclosed here in Table 3.2, none of Xstract's consultants or their immediate families involved in the preparation of this valuation report have (or had) a pecuniary or beneficial interest in BHP Billiton immediately prior to or during the preparation of this report.

Table 3.2: Consultant shareholdings in BHP Billiton as at 16 January 2015

Consultant	BHP Billiton shares held	Comments
J McKibben	0	
K Irving	114	Held in self-managed superfund.
I De Klerk	0	
R Marshall	0	
M Bowater	0	
M Creech	0	
G Trusler	0	
B Thornton	0	
S Barry	0	
M Longworth	0	13,397 shares held by father in a trust. Shares purchased in 1982, 1987 and 1992.

A draft version of this report was provided to representatives of SAEC for comment in respect of omissions and factual accuracy. SAEC has represented in writing to Xstract that full disclosure has been made of all material information and that to the best of its knowledge and understanding, such information is complete, accurate and true.

This report may contain or refer to forward-looking information based on current expectations, including, but not limited to timing of future production and economic viability of certain targets, Coal Reserve/Coal Resource estimates, future exploration or project development programmes and the impact of these events on SAEC's Coal Assets. Forward-looking information is subject to significant risks and uncertainties, as actual results may differ materially from forecasted results. Forward-looking information is provided as of the date hereof and Xstract assumes no responsibility to update or revise them to reflect new events or circumstances.

The conclusions expressed in this Competent Persons Report are appropriate as at 11 March 2015. The report is only appropriate for this date and may change in time in response to variations in economic, market, legal or political factors, in addition to ongoing exploration and development studies. All monetary values outlined in this report are expressed in United States Dollars ("USD") or South African Rands ("ZAR"), unless otherwise stated.

As SAEC is to be demerged from BHP Billiton, this report assesses the relevant Coal Assets and the associated economic benefits, risk and opportunities from SAEC's perspective, not that of BHP Billiton. Xstract notes that this report focusses on the operating assets of SAEC and only a limited study has been conducted in relation to the closed and defunct mines held by the company. Detailed assessment of the liability provisions associated with the closed and defunct mines is outside of the scope of this report. Xstract has relied on disclosures by SAEC regarding the provisions and liabilities associated with these assets.

4 SAEC

4.1 Overview

SAEC is a Johannesburg-based subsidiary company of BHP Billiton. SAEC's principal activities include exploration, development and operation of coal mines and coal processing

facilities, which produce energy coal products for the South African domestic and export markets.

Up until January 2007, SAEC was known as Ingwe Collieries Limited ("Ingwe"), a wholly owned subsidiary of Ingwe Coal Corporation Limited ("ICC"). ICC was initially formed following Gencor Limited's ("Gencor") merger of subsidiary, Trans-Natal Coal Corporation, with Rand Mines Limited's Coal Division ("Randcoal") in 1994. In 1997, ICC became part of Billiton Plc ("Billiton"), following Billiton's acquisition of Gencor's non-precious metal interests and subsequent listing on the South African and London Stock Exchanges. In 2001, BHP Limited and Billiton merged to create BHP Billiton. Through a series of internal rationalisations in 1998 and again in 2002, the coal interests of ICC were transferred to Ingwe and ICC changed its name to BHP Billiton SA Holdings Limited ("BHPB SA"). BHPB SA became the holding company for all of BHP Billiton's South African interests, which included its aluminium and manganese interests.

In 2012, SAEC became a private company (having been a public company since its inception).

Following a recent empowerment transaction, SAEC is now 90 per cent owned by BHP Billiton. A further 2 per cent is owned by SAEC's employees through an Employee Share Ownership Programme ("ESOP"), while the remaining 8 per cent is owned by a broad based Black Economic Empowered ("B-BBEE") consortium led by Pembani Holdings.

SAEC's assets are all located in South Africa near the towns of Witbank (eMalahleni) and Middelburg in the coalfields of Mpumalanga and Gauteng Provinces, South Africa. The key assets of SAEC comprise the following:

- A 100 per cent interest in the Wolvekrans-Middelburg Complex ("WMC") which for operational purposes is divided into the Wolvekrans Coal Mine ("Wolvekrans Mine"), the Middelburg Coal Mine ("Middelburg Mine") and SAEC Coal Processing ("BCP")¹⁰
- A 100 per cent interest in the Klipspruit Coal Mine ("Klipspruit Mine")
- A 100 per cent interest in the Khutala Coal Mine ("Khutala Mine")
- A 50 per cent interest in the Phola Coal Processing Plant
- A 100 per cent interest in the Klipspruit Extension
- A 100 per cent interest in the Leandra Coal Project ("Leandra Project"), which for operating purposes has been split into the Leandra North and Leandra South Projects
- A 100 per cent interest in the Naudesbank Coal Project ("Naudesbank Project")
- A 100 per cent interest in various exploration properties in South Africa, including the Union, Pegasus, Witbank South and Waterberg Coal Exploration Projects, and
- Various defunct and derelict coal mines in South Africa for which SAEC has legal responsibility and are the subject of on-going mine closure activities.

In addition to the above, SAEC also holds interests in other subsidiaries, joint ventures and associated companies hereinafter referred to as other assets (the "Other Assets"). These Other Assets include exploration companies, investment holding companies marketing companies, mineral right holding companies, mining related service companies and property holding companies.

Xstrat has been advised by SAEC that the exploration assets, defunct and derelict mines and Other Assets do not materially contribute to the equity value of SAEC and accordingly these have been excluded from consideration in this report.

¹⁰ Note: SAEC and Tavistock are joint holders of three Mining Rights in JV ratio (84:16). SAEC holds 100 per cent interest in fourth Mining Right. All four rights comprise the WMC. Under an agreement, the mining area is divided into an area wholly owned and operated by Tavistock, and an area wholly owned and operated by SAEC. For further details, refer to Section 5.2 and Appendix B.

Production in FY14 was 30.4 Mt, with the majority of these tonnages derived from the WMC. This was slightly lower than the 31.6 Mt produced in FY13. However, production in FY15 is forecast to rise to 32 Mt, of which 54 per cent is destined for domestic markets and 46 per cent for export. From an operational perspective:

- Middelburg Mine is a multi-seam, opencast operation expected to produce some 8.3 Mt ROM coal in FY15. There are two active pits excavated by draglines with the coal removed by front-end loader and trucks.
- Wolvekrans Mine actively mines five separate opencast pits and two truck and shovel operations, which are forecast to produce 18.1 Mt of RoM coal in FY15.
- BCP comprises three main beneficiation coal plants – North Plant, South Eskom Plant and South Export Plant. The North plant receives coal from the Middelburg Mine, which is processed to supply the export market. The South Eskom and South Export Plants receive coal from the Wolvekrans Mine, which is processed for supply to Eskom’s Duvha Power station and the export market, respectively. BCP is expected to produce 8.5 Mt of export saleable coal and 8.5 Mt of domestic saleable coal in FY15.
- Klipspruit Mine is a multi-seam open cast operation with a single dragline and a truck and shovel mini-pit operation. Mined coal is processed at the Phola plant (50:50 joint venture with Anglo Inyosi). In FY15, Klipspruit is expected to produce some 7.9 Mt of export saleable coal.
- Khutala Mine is predominantly an underground bord and pillar operation, which extracts No.2 and No.4 Seam coals. There is a small open pit operation extracting No.2, 4 and 5 Seam coals. Since 1986, Khutala has been tied to South Africa’s local utility company, Eskom’s nearby Kendal power station. Under the terms of the agreement, SAEC is to mine up to a stipulated tonnage of coal from the No.4 and No.2 Seams until 2033. SAEC is able to sell No.5 Seam coal to non-Eskom customers.

SAEC produces two main coal products for export; the 4,800 kcal/kg product, and the benchmark product (a thermal coal product targeting 6,000 kcal/kg net as received (“NAR”). SAEC undertakes a comprehensive blending strategy (involving ROM and washed coals) in order to produce these, and other, products in line with customer requirements. Washed product yields are optimised to meet prevailing market specifications.

These coals are transported by Transnet Freight Rail for export through RBCT, in which SAEC holds a 21 per cent interest (based on an 81 Mtpa throughput). This coal terminal is among the largest and most efficient of its kind in the world and provides SAEC with the infrastructure required for exporting to overseas markets. SAEC is South Africa’s third largest supplier to the seaborne energy coal market, SAEC’s coal products are sold into India, Europe, the Far East, and Africa.

A lower grade coal product is sold into domestic markets with the majority of this supply contracted to Eskom. In FY14, approximately 55 per cent of SAEC’s sales were to Eskom, placing SAEC as the fifth largest supplier to Eskom. Excluding Eskom, SAEC supplies relatively small quantities of coal into the South African market.

SAEC’s operations are positioned in the first half of the cost curve as shown in Figure 4.1.

Figure 4.1: Energy Coal Cash Cost Curve (FOB) – (USD/t, 2013)

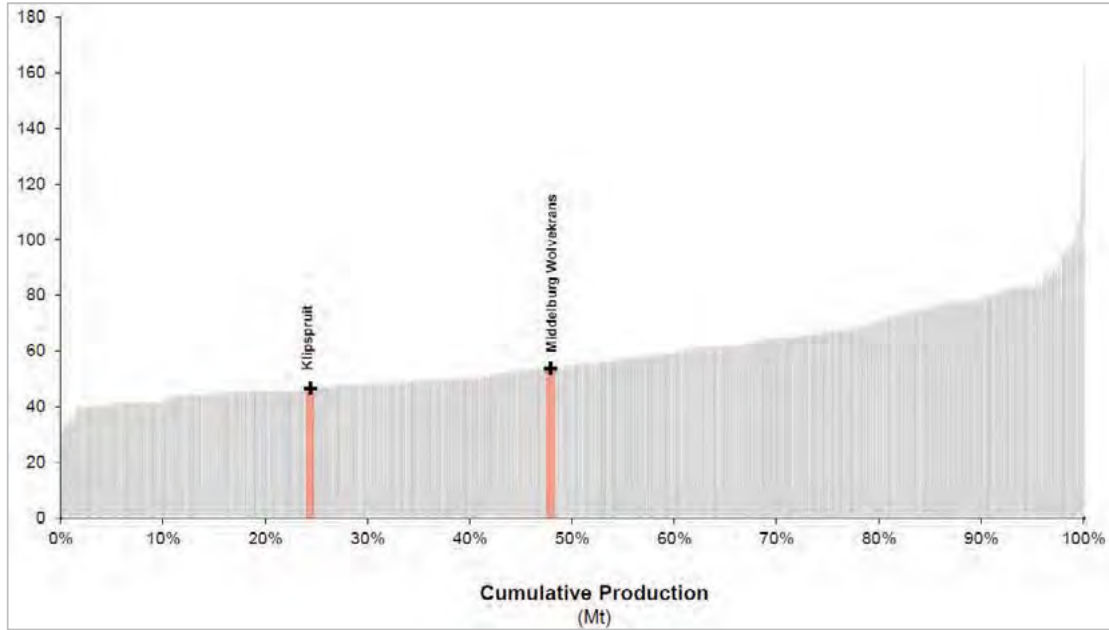

Source: Wood Mackenzie, spot prices as at 29 August 2014

Note: Klipspruit, Middelburg-Wolvekrans cash cost curve position is based on export thermal coal market. Khutala is not shown as it is tied to Eskom’s Kendal power station on a cost-plus price basis.

4.1.1 Structure

The SAEC portfolio consists of WMC (comprising Wolvekrans Mine, Middelburg Mine and BCP), Khutala, Klipspruit, Integrated Operations and Mine Closure Closed Mines (“MCCM”). Functional support is provided through various units including Corporate Affairs, Finance, HSEC (Health, Safety, Environment & Community), Human Resources, Key Strategies, Legal, Marketing, Projects, Resource Projects & Development.

The holding structure of SAEC is summarised in Figure 4.2, while the Administrative structure of SAEC is presented in Figure 4.3.

Figure 4.2: Holding structure of SAEC

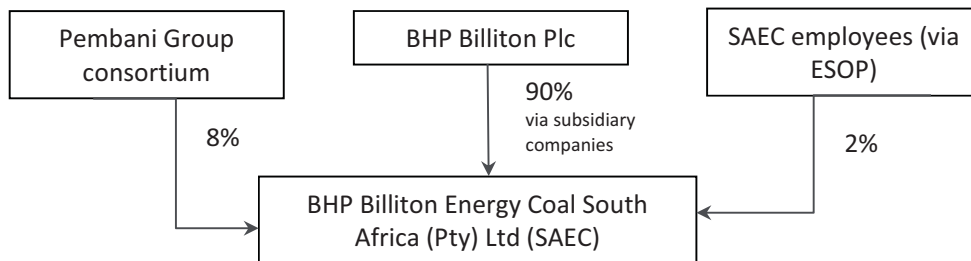

Subsidiary companies of SAEC (formerly Ingwe Collieries Ltd) include:

- Baniettor Mining Ltd (51 per cent)
- Douglas Colliery Ltd
- Douglas Colliery Services Ltd
- Ermelo Mines Services (Pty) Ltd
- Ingwe Housing Association
- Ingwe Surface Holdings Ltd
- Kangwane Anthracite (Pty) Ltd (60 per cent)
- Lehlaka Property Development (Pty) Ltd (50 per cent)
- Manhattan Syndicate Ltd (50.05 per cent)
- Middelburg Mine Services (Pty) Ltd
- Rietspruit Mine Services (Pty) Ltd

Figure 4.3: Administrative structure of SAEC

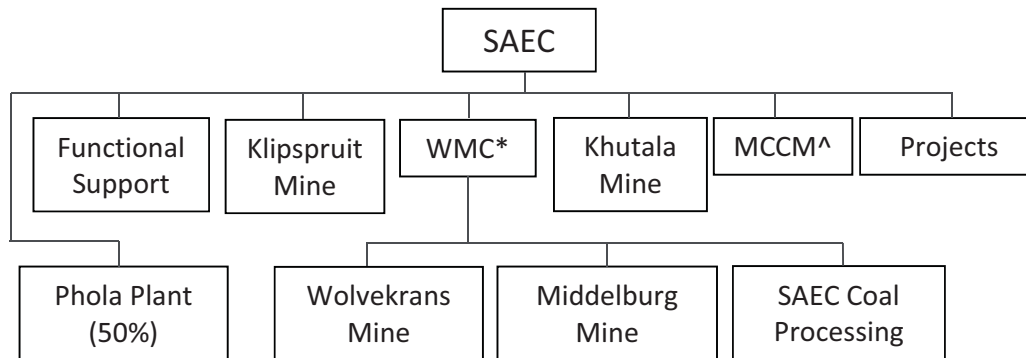

*WMC – Wolvekrans-Middelburg Complex
 ^MCCM – Mine Closure Closed Mines

4.1.2 Strategy

The reserve lives of SAEC’s mines range from 5.8 years at Khutala to 23 years at Middelburg. The WMC operations are forecast to provide base load to SAEC’s production profile until FY32, while declining production from Klipspruit and Khutala by FY20 requires replacement tonnages in the near term in order to sustain current production rates (Figure 4.4).

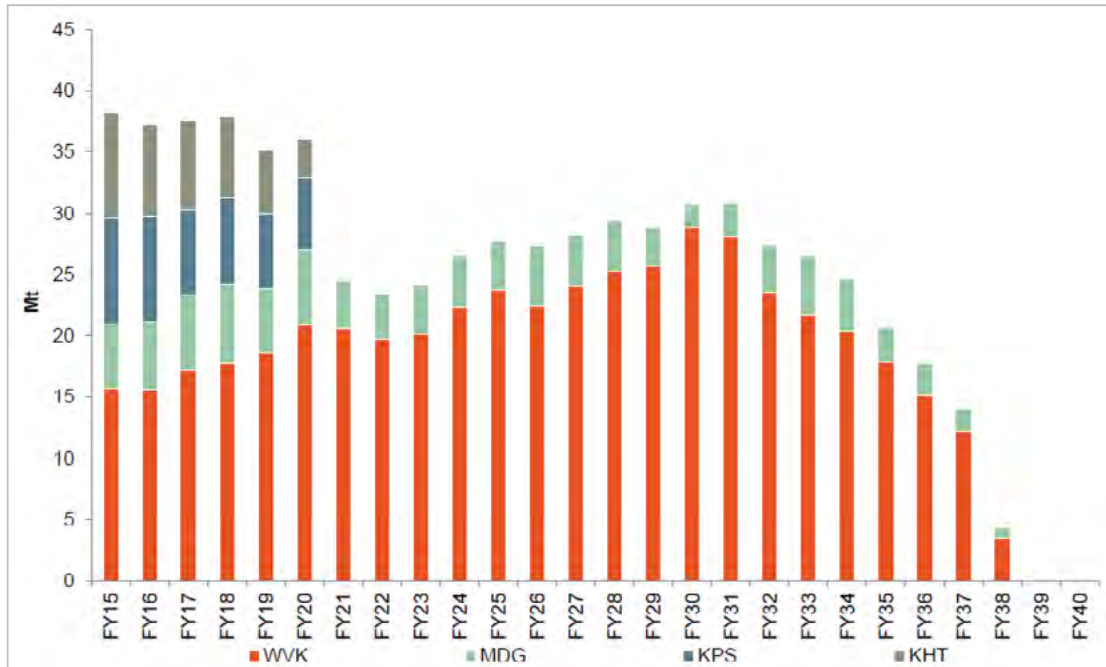
Figure 4.4: SAEC's Optimised Base Plan – Total ROM tonnes

Source: SAEC

In recent years, SAEC has been evaluating various options to extend the mine lives of its operations as economically available reserves diminish. Currently favoured development options include:

- Klipspruit Extension to encompass the Weltevreden Coal Resource and Klipspruit South area located immediately adjacent to the current Klipspruit Mine. This project is currently undergoing pre-feasibility level studies and if developed, this option extends the life of the Klipspruit Mine beyond 2020, uses existing processing and logistic infrastructure, and is well positioned to supply the export coal required to maintain current export volumes (approximately 7 Mtpa).
- Development via open cast mining of the Khutala life extension project and two potential underground extensions within the currently operating Khutala Mine. A further alternative currently being evaluated at Khutala is the development of three separate mini-pit operations at Block A West, KSA and Five seam Project.
- At Wolvekrans Mine, the open cast development of the BD area and several potential mini-pit operations.
- Greenfields development of the Leandra Project which lies directly adjacent to Sasol's existing operations and has the potential to supply a number of large domestic power stations in relative proximity to the Project such as Kendal, Kusile, Camden and Majuba, in addition to Sasol.

These strategic options along with others are evaluated elsewhere within this report.

4.1.3 Exploration expenditures

Given the operational and development status of the majority of SAEC's Coal Assets, the majority of exploration expenditure is related to drilling and conversion of defined Coal Resources. SAEC historic and budgeted expenditures are presented in Table 4.1.

Table 4.1: Drilling expenditures by development status (ZAR M)

Assets	2011	2012	2013	2014	2015b	2016b
Mining Assets	20.38	30.70	29.22	29.97	40.98	47.08
Wolvekrans	8.18	7.59	12.24	8.03	17.08	18.78
Middelburg	7.10	7.08	6.96	13.12	9.65	15.96
Klipspruit	3.10	6.52	4.12	7.01	10.11	7.79
Khutala	2.00	9.52	5.90	1.81	4.14	4.55
Development Assets	12.53	4.30	4.25	5.54	23.14	18.06
Weltevreden	4.32	-	-	1.34	4.20	7.90
Leandra North	-	-	0.87	1.69	18.94	10.16
Leandra South	8.21	4.30	3.38	2.51	-	-
Naudesbank	-	-	-	-	-	-
Exploration Assets	2.72	0.04	0.41	-	22.94	20.54
Pegasus	0.32	0.04	0.41	-	-	-
Witbank	0.17	-	-	-	-	-
Miscellaneous	2.23	-	-	-	22.94	20.54

Source: SAEC, Xstract

b=FY budget, all other figures are FY actuals

¹ Includes VDDC project to gain access to central Wolvekrans resources² Includes Albion project to upgrade resource³ Includes Klipspruit South

NB: Any discrepancies are due to rounding

4.1.4 Workforce

SAEC's operations currently employ approximately 10,000 full time equivalent ("FTE") employees, of which some 48 per cent are employees with the remainder, contractors. SAEC's employee numbers have reduced by approximately 350 people since FY11, with numbers forecast to remain steady at around 4,850 over the period FY15 to FY19.

A significant proportion of the workforce belong to a union, with the National Union of Mineworkers ("NUM") holding the greatest membership, followed by the Association of Mineworkers and Construction Union ("AMCU") and United Association of South Africa ("UASA").

4.2 Location, access and local resources

SAEC's coal mining and development interests reside within an area broadly defined by latitudes 25°45' S to 26°33' South and longitudes 28°39' to 30°09' East, which covers the Witbank, Highveld and Ermelo Coalfields of Mpumalanga and Gauteng Provinces, South Africa (Figure 4.5). This area is covered by the Pretoria (2528), East Rand (2628), Barberton (2530) and Mbabane (2630) 1:250,000 series map sheets.

Figure 4.5: Location of SAEC's current operations, Development Projects and Exploration areas



Source: SAEC

SAEC's Mining Assets are all located in the Witbank and Middelburg portions of the Steve Tshwete Local Municipality, which form part of the Nkangala District Municipality. The towns of Witbank (eMalahleni) and Middelburg lie in close proximity and to the north of SAEC's current coal mining and processing operations. Other significant towns and settlements include Bethal, Secunda, Delmas, Ermelo, Leandra, Carolina, Ogies, Kriel, Hendrina, Koorfontein, Vandykesdrift and Rietspruit. In addition, there are various farms and homesteads surrounding the mining areas.

Witbank lies approximately 130 km east of Johannesburg, and 200 km west-southwest of Nelspruit, the provincial capital of Mpumalanga Province. The area is well-connected by means of freeways and regional road network. The N12 and N4 freeways provide access to Gauteng Province, with Johannesburg approximately 2 hours' drive to the west along the N12. The N4 connects Witbank with Middelburg, Belfast, Waterval-Boven and Nelspruit, as well as Maputo in Mozambique. The R547 and R35 are a prominent north/south routes, which together with the R575, R547 and R545, provides internal linkages to the south, specifically Ogies, Bethal, Davel, Ermelo and Secunda. Sealed provincial roads provide access to all of SAEC's mines.

The area is favourably located in terms of the railway system. There are two main lines; the first runs parallel to the N4 freeway, and connects Witbank with Pretoria and the Maputo harbour, and the second runs parallel to the N12 freeway, and connects Witbank with Germiston, which is the point of convergence of all railway infrastructure in Southern Africa.

These lines ultimately connect to the Richards Bay Rail Line ("RBRL"), which is the main railway line used to export coal from the region via the Richards Bay harbour. Several spur lines and rail sidings exist in the area and connect to SAEC's processing facilities. The RBRL is a 1,067 mm double line that is bi-directionally signalled and fully electrified. All trains are electric with 82 t tipping wagons that are usually joined at Ermelo. These trains stretch 2.5 km and are loaded to 20,800 t. Current capacity is around 73 Mtpa but is being expanded to allow for some 81 Mtpa of coal freight to RBCT.

There is an airfield situated north of Witbank. This airfield is owned and operated by the Witbank Municipality. The runway is short, which limits the use of the airfield to small aircraft.

Witbank (population approximately 110,000) and Middelburg (pop. 90,000) collectively provide a high standard of education, medical, recreation, retail and professional services (including legal, financial and major banking institutions). The area surrounding Witbank and Middelburg has high associated economic activity, as well as a concentration of thermal power stations. The surrounding area also hosts numerous third party owned coal mining operations, several coal-fired power stations (Kendal and Duvha being of most importance to SAEC) and benefits from excellent road, rail, rail siding and power infrastructure.

This has resulted in a ready pool of labour in the Witbank, Middelburg, Ogies and Delmas areas, much of which has previous experience in the mining sector. There are also a number of experienced mining contracting companies operating in the region.

Potable water is supplied to SAEC's operations, either by Eskom as part of the relevant Coal Supply Agreement or the applicable Water Scheme pipeline. Process water is supplied to South Africa Energy Coal's operations under the relevant Integrated Water Use License.

There is an abundance of electricity options in the Witbank/Middelburg area with more than 18,400 megawatts ("MW") of installed capacity (at Arnot, Hendrina, Duvha, Kriel, Matla and Kendal power stations), a further 1,000 MW at the mothballed Komati station and 4,800 MW under currently construction at the Kusile power station. Electrical supply for SAEC's mining operations is generally reliable throughout the year.

4.3 Climate, physiography and land use

SAEC's projects are located in the Mpumalanga Highveld region, which experiences a dry, temperate climate conducive to continuous mining operations year round. December to February are the hottest months with average daily maximum temperature of approximately 27°C (with occasional extremes up to 35°C). Summers are accompanied by higher precipitation rates, mostly in the form of brief, afternoon convectional showers and thunderstorms, but also as mist, rain or hail. By comparison, winters range from mild to cold, with average daily maximum temperatures of 15°C (with occasional extreme minima as low as -10°C). Frost and mist are frequent during the winter months (May to August).

Mean annual precipitation in the area is between 650 and 900 mm with 85 per cent of the annual rainfall occurring between October and March. Mean annual evaporation in the region is approximately 1,600 mm, and is highest from October to January, due to high summer temperatures.

The general topography of the area is characterised by flat to gently rolling terrain with mostly north-flowing drainage systems. The drainage pattern is dendritic, with various unnamed streams feeding into the main rivers of the area namely the Klein-Olifants, Olifants, Wilge River, Reitspruit, Steenkoolspruit and Brugspruit Rivers. A large number of pans and wetlands occur across the area causing drainage problems for proposed developments. Elevations typically range from 1,500 to 1,650 m above sea level, with

average gradients across the area typically less than 1°. Slopes along the sides of the pans vary between 4.5 and 8 per cent, somewhat steeper than those of the surrounding lands.

Vegetation is dominated by grasses, bulbs, tubers and lesser trees, which are representative of the Grassland Biome of the Mpumalanga Highveld region.

Mining contributes significantly to the regional economy and is one of the largest contributors to employment within the area. The availability and supply of cheap coal is instrumental to the success of the manufacturing sector in the region, particularly the steel and electricity sectors. The major economic activities in the area are steel making, coal mining, power generation, agriculture, commerce and light engineering.

4.4 Tenure

4.4.1 Legislative framework

The South African Government has an extensive legal framework within which mining, environmental and social aspects are managed with at least 17 statutory processes applicable. Three Acts however are seen as constituting the overarching legislation; namely the Minerals and Petroleum Resources Development Act (Act 28 of 2002) ("MPRDA"), National Environmental Management Act (Act 107 of 1998) ("NEMA") as amended in 2006, and National Water Act (Act 36 of 1998) ("NWA").

Minerals and Petroleum Resources Development Act, 2002

The South African mining sector is regulated primarily by the MPRDA. This Act prescribes the system by which Mining and Prospecting Rights are granted and regulated. To conduct mining activities, a Mining Right or Mining Permit is required; and for prospecting activities, a Prospecting Right is required. As provided for in the MPRDA and amendments, Table 4.2 summarises the types of rights and permits pertaining to the mining industry in South Africa.

Any person conducting prospecting must comply with an approved Environmental Management Plan ("EMP"). An EMP is a plan to manage and rehabilitate environmental impacts associated with prospecting. Any person conducting mining must comply with an approved Environmental Management Programme ("EMPr"). The EMPr is prepared following an Environmental Impact Assessment ("EIA") as prescribed in the MPRDA and its Regulations. The competent authority is the Department of Mineral Resources ("DMR"). EMPr and EMP are terms sometimes used erroneously as synonyms.

The granting of a Prospecting or Mining Right will not take effect prior to the approval of the EMP or EMPr, and the effective date of a right is either the date the right is notarially executed, or the EMP or EMPr is approved, whichever is later.

Prior to 2002, EMPr's were approved under the Minerals Act, 1991 (Act No. 50 of 1991).

Importantly, under Section 11 of the MPRDA, Ministerial Consent is required if a Prospecting Right, or a Mining Right, or a majority interest in any such right is to be ceded, transferred, let, sublet, assigned, alienated or otherwise disposed of. This consent must be granted, if the person to whom the right will be alienated or disposed of is capable of carrying out and complying with the obligations and the terms and conditions of the right in question and satisfies the requirements of Section 17 (Prospecting Rights) or Section 23 (Mining Rights) of the MPRDA.

Table 4.2: Types of rights applicable in South Africa

Licence Type	Purpose	Duration	Requirements	Conditions
Reconnaissance Permission	Reconnaissance level exploration	1 year (non-renewable)	Financial ability, technical ability and work programme.	Holder does not have exclusive right to apply for a Prospecting Right.
New Order Prospecting Right	Target definition level exploration	Up to 5 years initially, renewable once for 3 years.	Financial ability, technical ability, economic programme, work programme and environmental plan.	Payment of Prospecting fees. Continuously and actively conduct prospecting operations in line with work programme. Comply with Environmental authorisation. Exclusive right to apply for a Mining Right.
Retention Permit	Retain legal right whilst economic viability established.	3 years initially, renewable once for 2 years.	Prospecting and feasibility study complete and Environmental Management Plan complete. Project not currently feasible.	Not allowed to exclude competition, unfair competition or hoard rights. May not be transferred, ceded, leased, sold mortgaged or encumbered in any way.
New Order Mining Right	Development and production	30 years initially, renewable for further periods of 30 years. Effective for life of mine.	Financial ability, technical ability, prospecting complete, economic programme, work programme social plan, labour plan and completed environmental management plan.	Payment of royalties. Exclusive right of renewal. Actively conduct mining in line with work programme. Compliance with Mining Charter, environmental authorisation, the social and labour plan. Submit annual report
Mining Permit	Small-scale mining	2 years initially. Renewable for 3 further periods of 1 year.	Life of project must be less than 2 years, areas must be less than 5 ha and completed environmental management plan.	Payment of royalties. May not be leased or sold.

National Environmental Management Act, 1998 (Act No. 107 of 1998)

Many of the activities to be conducted for mining operations (such as the construction of pipelines or roads) may also require environmental authorisation under the National Environmental Management Act ("NEMA") EIA Regulations. In these situations, in addition to requiring an EMP or an EMPr and authorisation under the MPRDA, an environmental authorisation under the NEMA EIA Regulations will also be required (refer National Environmental Laws Amendment Act, 2014). In the Mpumalanga Province, these applications are made to the Mpumalanga Department of Economic Development, Environment and Tourism ("MDEDET").

Prior to 2010, certain mining related activities required a Record of Decision ("RoD") under the Environment Conservation Act, 1989 (Act No. 73 of 1989).

National Water Act, 1998 (Act No. 36 of 1998)

The National Water Act (“NWA”) requires almost all water uses (abstraction, storage, waste disposal, discharge, removal of underground water and alteration to water courses) above certain thresholds to be licensed and registered by means of a Water Use Licence (“WUL”).

In practice, mines are called upon to submit Water Use License Applications (“WULA”) or an Integrated Water Use Licence Application (“IWULA”) together with an Integrated Water and Waste Management Plan (“IWWMP”) to the Department of Water and Sanitation (“DWS”) for authorisation.

Mines are also required to comply with the Regulations on Use of Water for Mining and Related Activities Aimed at the Protection of Water Resources promulgated under the NWA (GN R.704).

According to the National Water Act, Act No. 36 of 1998, a wetland is defined as:

“land which is transitional between terrestrial and aquatic systems, where the water table is usually at or near the surface or the land is periodically covered with shallow water, and which land in normal circumstances supports or would support vegetation typically adapted to life in saturated soil.”

This implies that rivers, ponds and even ephemeral streams are also wetlands.

National Environmental Laws Amendment Act, 2014 (Act No 25 of 2014) (NEMLA)

It is contemplated in the National Environmental Laws Amendment Act, 2014 (Act No 25 of 2014) (“NEMLA”) that the DMR will be the sole regulatory authority for environmental matters relating to mining, even though the mechanism to be applied will be the Regulations framed in accordance with the NEMA. Accordingly, future environmental applications for listed activities are to be made to the DMR. This is a subject of much debate and legislative and procedural uncertainty ensues.

Additional legislation

In addition to those listed above, further mining related legislation is in place covering various aspects including, but is not limited to; health and safety, water use, atmospheric emissions, air quality, waste, roads, heritage, security of tenure, hazardous substances, explosives, employment equity, mineral royalties, and mineral development.

4.4.2 Environmental aspects

There is a great deal of concurrent or overlapping legislation, which applies to mining operations. A key question for mine operators is whether the mining laws in the form of MPRDA is the only legal requirement to be adhered to on mining land. This issue has been the subject of great debate in the past between legal professionals, with certain counsel opinions that mining activities were solely regulated by the DMR.

SAEC has applied for all environmental and mining legislative requirements under the MPRDA, but since the legislative provisions were not clear, the Company did not in all circumstances apply for environmental authorisation for ancillary mining activities required in terms of NEMA. This is a common problem encountered by mining companies in South Africa. The mines have subsequently decided to obtain environmental authorisations for listed activities associated with several Mining Right and Section 102 Applications as defined in the listing notices published in terms of NEMA. Section 24G of NEMA provides for a rectification application process where companies have the opportunity to pay an

administrative fine for commencing or continuing a listed activity, which required an environmental authorisations in terms of NEMA. Xstract has been assured by SAEC's management that the Section 24G applications which have either been lodged, or will shortly be lodged, are for relatively minor issues such as pipelines, haul roads and stream crossings. SAEC do not consider these applications are of sufficient magnitude to damage the reputation of the company. This is a common scenario in the South African mining industry.

In regards to Section 24G applications, SAEC has completed a legal gap analysis and is applying for the various activities as noted in the compliance assessments. The compliance offices of the DMR, as well as the MDEDET, have visited the sites and therefore surprise finds should be limited.

Wolvekrans has submitted a Section 24G application for activities not previously applied for. Middelburg is currently compiling a Section 24G application and will be paying a fine for activities started after 2010, mostly on haul roads and pipelines. A Section 24G application has also been submitted for Khutala.

The environmental aspects of each project are discussed in the respective sections of this report.

4.4.3 Black Economic Empowerment

The Mining Charter requires South African mining companies to have a 26 per cent Black Economic Empowerment ("BEE") ownership by 2014.

In order to enhance SAEC's BEE credentials, the Company has undertaken a progressive divestment programme, implemented an ESOP and been involved in numerous empowerment transactions including with Eyesizewe Coal (Pty) Ltd (now Exxaro Resources Limited), Optimum Coal Holdings Limited, Kuyasa Mining (Pty) Ltd, Scinta South Africa (Pty) Ltd and Umcebo Mining (Pty) Ltd.

As a result of these actions, BHP Billiton has now officially met its obligations under the Mining Charter and is able to maintain an 90 per cent interest in SAEC going forward.

SAEC's BEE Audit Certificate is presented in Appendix A.

4.4.4 Mining Rights

SAEC holds six granted Mining Rights and one Mining Right Application as summarised in Figure 2.1 and Table 4.3.

In regards to the three mining rights held jointly by SAEC (84 per cent) and Glencore (16 per cent via subsidiary companies) at WMC, Xstract notes that SAEC has applied to the Minister of the Department of Mineral Resources for ministerial consent to amend the mining rights so that each company would obtain an amended mining right in respect of their areas. The Ministerial consents to amend the companies mining rights have been approved, with the only outstanding requirement being the notarial execution and registration of the amended mining rights.

Table 4.3: Schedule of SAEC's Mining Rights

Asset	DMR Number	Expiry	Area (ha)	SAEC interest	Comments
Wolvekrans	MP30/5/1/2/2/376 MR	1 Dec 2041	13,347.03	84%	Able to be renewed for periods of 30 years each
Wolvekrans	MP30/5/1/2/2/377 MR	10 Oct 2041	1,182.33	100%	Able to be renewed for periods of 30 years each
Wolvekrans	MP30/5/1/2/2/378 MR	26 Oct 2041	572.62	84%	Able to be renewed for periods of 30 years each
Wolvekrans	MP30/5/1/2/2/379 MR	1 Dec 2041	18,938.06	84%	Able to be renewed for periods of 30 years each
Klipspruit	MP30/5/1/2/2/125 MR	10 Oct 2041	2,165.31	100%	Able to be renewed for periods of 30 years each
Khutala	MP30/5/1/2/2/118 MR	10 Oct 2041	9,321.14	100%	Able to be renewed for periods of 30 years each
Pegasus	MP30/5/1/2/2/10075 MR	Grant pending	919.668	100%	Applied for 10 years

Source: SAEC -- for full details of SAEC's Material Assets refer to Appendix B

4.4.5 Prospecting Rights

SAEC holds 14 granted Prospecting Rights and one Prospecting Right Application as summarised Figure 2.1 and Table 4.4.

Table 4.4: Schedule of SAEC's Prospecting Rights

Prospecting Rights Name	DMR Number	Expiry	Area (ha)	SAEC Interest	Comments
Leandra - Mpumalanga	MP30/5/1/1/2/1151 PR	27 Sep 2015	38,144.71	100%	No further right of renewal
Leandra - Balance of Old Delmas Mine	MP30/5/1/1/2/418 PR	27 Sep 2015	3,769.33	100%	No further right of renewal. Portion of right divested to Kuyasa.
Leandra Gauteng	MP30/5/1/1/2/223 PR	29 Jan 2011	8,715.8339	100%	Renewal granted, but not yet commenced
Leandra Winterhoek	GP30/5/1/1/2/59PR	11 Nov 2015	827.00	100%	
Leandra Leeuwkop	MP30/5/1/1/2/221 PR	29 Jan 2011	1,433.75	100%	Renewal granted, but not yet commenced
Naudesbank	MP30/5/1/1/2/1057 PR	16 Aug 2011	9,132.71	100%	Renewal pending
Weltevreden - Grootpan	MP30/5/1/1/2/1028 PR	16 Aug 2011	1,308.83	100%	Renewal pending. Application to include in Klipspruit pending.
Weltevreden - Private	MP30/5/1/1/2/1058 PR	16 Aug 2011	4,499.32	100%	Renewal pending. Application to include in Klipspruit pending.
Weltevreden - Tweefontein	MP30/5/1/1/2/21 PR	11 Aug 2015	1,519.56	100%	Still in initial 5 year period. Application to include in Klipspruit pending.
Middelburg Mine (Despatch Rider)	MP30/5/1/1/2/416 PR	4 Oct 2011	520.47	100%	Renewal pending

Prospecting Rights Name	DMR Number	Expiry	Area (ha)	SAEC Interest	Comments
Remhoogte (Private)	MP30/5/1/1/2/98 PR	Grant pending	10,932.78	100%	Grant of initial right pending
Remhoogte (State)	MP30/5/1/1/2/119 PR	11 Aug 2015	785.28	100%	Right in initial 5 year period.
Union Existing	MP30/5/1/1/2/1100 PR	4 Oct 2011	4,050.40	100%	Renewal pending
Union Vaalbank	MP30/5/1/1/2/218 PR	4 Oct 2011	3,579.23	100%	Renewal pending
Waterberg	MP30/5/1/1/2/227 PR	16 Nov 2011	6,426.37	100%	Renewal pending
Witbank	MP30/5/1/1/2/253 PR	4 Oct 2011	1,378.96	100%	Renewal pending

Source: SAEC – for full details of SAEC’s Material Assets refer to Appendix B

4.4.6 Prospecting Rights subject to a Sale Agreement

As discussed previously, SAEC is currently in the process of divesting six granted Prospecting Rights as summarised in Figure 2.1 and Table 4.5.

Table 4.5: Schedule of SAEC Prospecting Rights subject to a Sale Agreement

Prospecting Rights Name	DMR Reference Number	Expiry	Area (ha)	Comments
Davel	MP30/5/1/1/2/254 PR	12 Aug 2017	23,975.70	No further right of renewal. Divested.
Ermelo Mine (50% share)	MP30/5/1/1/2/4570 PR	N/A	4,575.72	Renewable. Divested.
Leandra - Winterhoek	MP30/5/1/1/2/59 PR	11 Nov 2015	827.00	No further right of renewal. Divested.
Leandra – portion of Old Delmas Mine	MP30/5/1/1/2/418 PR	27 Sep 2015	2,365.18	No further right of renewal. Divested.
New Delmas	MP30/5/1/1/2/4571 PR	27 Sep 2017	7,420.09	Renewable. Divested.
Newcastle	MP30/5/1/1/2/37 PR	27 Aug 2019	3,268.67	Renewable. Divested.

Source: SAEC

SAEC’s retained Material Mining and Prospecting Rights are discussed further in the following sections.

4.4.7 Contracts

SAEC has entered into various contracts including, but not limited to:

- Coal supply and sales agreements
- conduct and compensation agreements with the local council (for certain roads and reserves) and various other landholders (mainly farm owners)
- Electricity and water supply contracts
- Consumables supply including fuels and lubricants and reagents
- Transport agreements including rail haulage and materials handling services that includes take-or-pay limits for both SAEC and Transnet Freight Rail (“TFR”)
- Various asset management and engineering supply/services contracts
- Security.

Xstract has carried out a high-level review of SAEC’s material contracts and considers them broadly in line with industry practice and supportive of on-going operations. Xstract

understands that full details regarding the legal status of SAEC's contracts are provided elsewhere within the Listing Documents.

4.4.8 Legal claims and litigation

Other than as disclosed in this report, Xstrat has not been made aware of any legal claims or litigation pertaining to the technical, operational and cost aspects of the SAEC's Coal Assets going forward.

4.5 Regional geology

South Africa's Coal Resources are predominantly hosted within late Carboniferous to middle Jurassic sedimentary units of the Karoo Basin (320 to 180 Ma) to the east of longitude 26°E (Figure 4.6). Within the Basin, coal is principally hosted in the Vryheid Formation ("Fm") of the Ecca Group ("Gp") and the Normandien Formation of the Beaufort Group (Table 4.6 and Figure 4.7). The Molteno Formation of the Eastern Cape is also known to host coal deposits.

Figure 4.6: Location of the Karoo Basin in South Africa

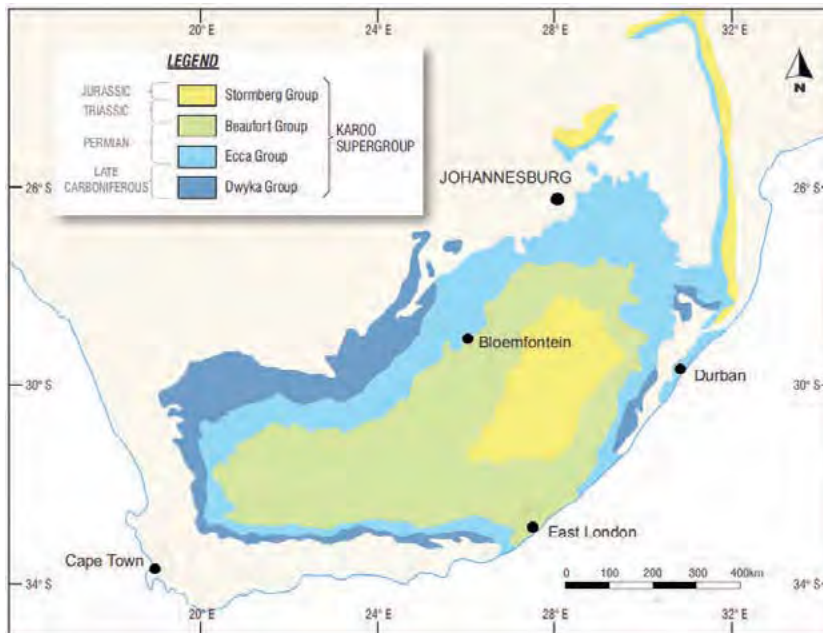

Source: modified after Tankard et al, 1982

Figure 4.7: Karoo Basin Cross Section

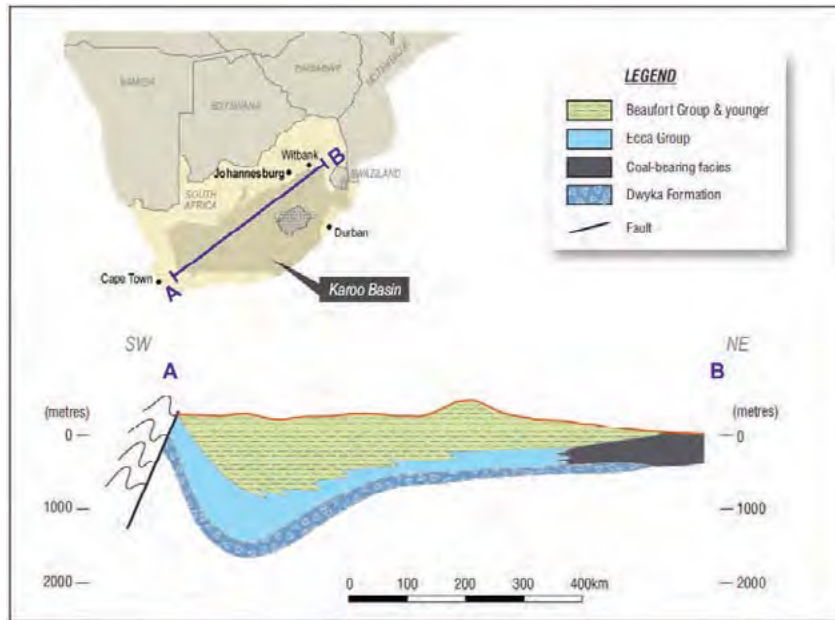

Source: modified after Tankard et al, 1982

Table 4.6: Simplified stratigraphy of the Karoo Basin

Formation or Group	Southwest	Northeast	Age
Drakensberg Gp	Flood basalt		Middle to Early Jurassic approx. 180 Ma
Clarens Fm	Aeolian sandstone		Early Jurassic
Elliot Fm	Red mudstone and sandstone		Late Triassic
Molteno Fm	Sandstone, mudstone and minor coal	Sandstone and mudstone	Late Triassic, approx. 210 Ma
Beaufort Gp	Blue green shales, mudstones and sandstones	Mudstone and shale of the Driekoppen Fm	Early Triassic
		Conglomerate, coarse to medium grained sandstone of the Verkykerskop Fm	
		Sandstone, mudstone, coal of the Normandien Fm	
Ecca Gp	Grey to black shale and mudstone, subordinate sandstone	Shale and mudstone of the Volksrust Fm	Early to Middle Permian, approx. 260 Ma
		Feldspathic sandstone, shale, mudstone and coal of the Vryheid Fm	
		Shale and mudstone of the Pietermaritzburg Fm	
Dwyka Gp	Tillite, minor sandstone and shale	Tillite, fluvio-glacial conglomerate, shale and dropstones	Early Permian to Late Carboniferous, approx. 320 Ma

South Africa hosts 19 coalfields covering a combined area of more than 97,000 km² (Figure 4.8). Based on Coal Reserves, the Highveld and Witbank Coalfields are the largest, followed by the Ermelo and Waterberg Coalfields. Bituminous coals predominate. South Africa's main electricity supplier, the Electricity Supply Commission ("Eskom") has built many coal-fired power stations specifically designed to use low-grade coals within the Witbank Coalfield.

Figure 4.8: Location of the Karoo Basin and South African Coalfields

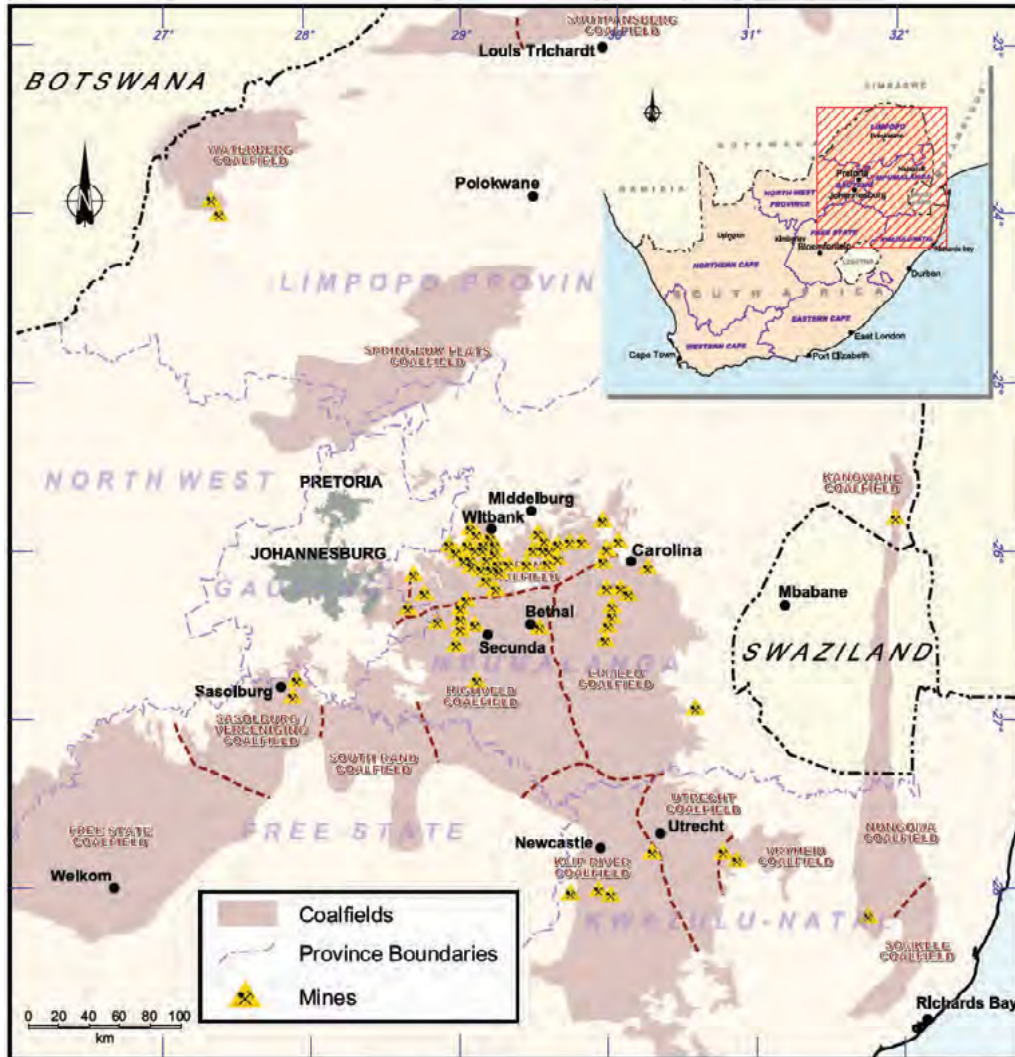

Source: SAEC

The Witbank Coalfield is the largest producing coalfield in South Africa, supplying more than 50 per cent of South Africa's saleable coal (Coffey, 2010). It covers an area in excess of 5,600 km², extending from the town of Springs in the west to the town of Belfast in the east (Figure 4.8), and southwards to the Springfield Ridge, which separates the Witbank Coalfield from the Highveld Coalfield to the south. The main mining areas occur near the towns of Witbank, Ogies, Middelburg and Belfast, from which the coalfield produces both metallurgical coal and A-grade to D-grade thermal coal for local and export markets.

Within the Witbank, Highveld and Ermelo Coalfields, there are five vertically stacked depositional sequences, with associated coal seams, developed within the Vryheid

Formation of the Ecca Group. These coal-bearing sequences lie either directly on the pre-Karoo basement, or on the Dwyka Group glacial strata.

The coal seams are numbered from No.1 (at the base) to No.5 (at the top of the sequence). The distribution and extent of the No.1 and No 2 Seams are primarily controlled by the pre-Karoo topography, particularly erosional glacial valleys, with the No.4 and No.5 Seams controlled by the present day land surface. In some areas, parts or all of these seams have been lost to erosion.

4.6 Coal Resource and Coal Reserve statements

The Coal Resources and Coal Reserves breakdown by classification (100 per cent basis) as at 30 June 2014 are reported in Table 4.7 and Table 4.9 respectively. All tonnes and quality information is on an air-dried basis and has been rounded, hence small differences may be present in the totals. All Coal Resources outlined are inclusive of Coal Reserves unless stated otherwise.

These estimates were then depleted to restate the Coal Resources and Coal Reserves as at 31 December 2014, a date as close as practically possible to South32's proposed listing date. The depletion of Coal Reserves and Coal Resources was achieved by taking into account actual production to 30 October 2014 and forecast production to 31 December 2014. For transparency, the Coal Resources and Coal Reserves as at 31 December 2014 are presented in Table 4.8 and Table 4.10.

Table 4.7: Coal Resources as at 30 June 2014 (adb) in 100 per cent terms

Project	Measured Resource					Indicated Resource					Inferred Resource					Total Resource				
	Mt	CV (kcal/ kg)	VM (%)	Ash (%)	TS (%)	Mt	CV (kcal/ kg)	VM (%)	Ash (%)	TS (%)	Mt	CV (kcal/ kg)	VM (%)	Ash (%)	TS (%)	Mt	CV (kcal/ kg)	VM (%)	Ash (%)	TS (%)
Mining Assets																				
Wolvekrans (OC)	496	5,600	23.2	25.9	1.16	18	5,100	22.7	30.0	1.02	118	5,100	23.1	30.2	1.06	632	5,490	23.2	26.8	1.14
Middelburg (OC)	211	5,410	21.7	28.0	1.04	-	-	-	-	-	7.3	5,600	22.1	24.7	0.88	218	5,420	21.7	27.9	1.04
Klipspruit (OC)	138	5,220	22.4	27.6	1.23	-	-	-	-	-	1.1	4,950	21.5	29.8	1.28	139	5,220	22.4	27.6	1.23
Khutala (OC & UG)	1,331	4,750	22.0	31.8	1.12	-	-	-	-	-	-	-	-	-	-	1,331	4,750	22.0	31.8	1.12
Development Assets																				
Weltevreden	192	5,150	22.1	29.2	1.30	212	4,970	21.7	31.1	1.14	143	5,050	21.9	30.6	1.18	547	5,050	21.9	30.3	1.21
Leandra North	210	4,990	23.1	27.7	1.30	194	5,030	23.4	27.3	1.24	103	5,060	23.5	27.0	1.23	507	5,020	23.3	27.4	1.26
Leandra South	10	4,700	20.8	28.1	0.93	132	4,910	22.0	27.1	1.02	938	5,030	22.4	26.0	1.00	1,080	5,010	22.3	26.2	1.00
Naudesbank	103	5,550	25.4	25.4	1.10	132	5,610	25.5	24.9	1.06	54	5,580	25.2	25.3	1.08	289	5,580	25.4	25.2	1.08

Source: BHP Billiton Annual Report 2014

Note:

T Project, Rem Block IV and Davel assets have been divested, or are being divested, and are not reported here.

Table 4.8: Coal Resources as at 31 December 2014 (adb) in 100 per cent terms

Project	Measured Resource					Indicated Resource					Inferred Resource					Total Resource				
	Mt	CV (kcal/ kg)	VM (%)	Ash (%)	TS (%)	Mt	CV (kcal/ kg)	VM (%)	Ash (%)	TS (%)	Mt	CV (kcal/ kg)	VM (%)	Ash (%)	TS (%)	Mt	CV (kcal/ kg)	VM (%)	Ash (%)	TS (%)
Mining Assets																				
Wolvekrans (OC)	488	5,600	23.2	25.9	1.16	18	5,100	22.7	30.0	1.02	118	5,100	23.1	30.2	1.06	624	5,490	23.2	26.8	1.14
Middelburg (OC)	207	5,410	21.7	28.0	1.04						7.3	5,600	22.1	24.7	0.88	214	5,420	21.7	27.9	1.04
Klipspruit (OC)	132	5,220	22.4	27.6	1.23						1.1	4,950	21.5	29.8	1.28	133	5,220	22.4	27.6	1.23
Khutala (OC & UG)	1,326	4,750	22.0	31.8	1.12										1,326	4,750	22.0	31.8	1.12	
Development Assets																				
Weltevreden	192	5,150	22.1	29.2	1.30	212	4,970	21.7	31.1	1.14	143	5,050	21.9	30.6	1.18	547	5,050	21.9	30.3	1.21
Leandra North	210	4,990	23.1	27.7	1.30	194	5,030	23.4	27.3	1.24	102	5,060	23.5	27.0	1.23	507	5,020	23.3	27.4	1.26
Leandra South	10	4,700	20.8	28.1	0.93	132	4,910	22.0	27.1	1.02	938	5,030	22.4	26.0	1.00	1,080	5,010	22.3	26.2	1.00
Naudesbank	103	5,550	25.4	25.4	1.10	132	5,610	25.5	24.9	1.06	54	5,580	25.2	25.3	1.08	289	5,580	25.4	25.2	1.08

Source: BHP Billiton Annual Report 2014 and updated in November 2014

Note:

T Project, Rem Block IV and Davel assets have been divested, or are being divested, and are not reported here.

Table 4.9: Coal Reserves as at 30 June 2014 (adb) in 100 per cent terms

Project	Mining Method	Proved	Probable	Total	Proved Marketable Reserve				Probable Marketable Reserve			
		Mt ROM (adb)	Mt ROM (adb)	Mt ROM (adb)	Mt (adb)	Ash (%)	CV (kcal/ kg)	TS (%)	Mt (adb)	Ash (%)	CV (kcal/ kg)	TS (%)
Wolvekrans	Opencast	389	17	406	273	21.8	6,010	0.47	12	22.5	5,950	0.45
Middelburg	Opencast	97	0	97	80	23.2	5,890	0.47	-	-	-	-
Klipspruit	Opencast	43	0	43	36	23.0	5,800	0.82	-	-	-	-
Khutala	Underground	36	0	36	33	33.6	4,440	0.76	-	-	-	-
	Opencast	1.4	0	1.4	1.3	35.7	4,640	1.15	-	-	-	-
TOTAL		566	17	583	423	23.1	5,840	0.50	12	22.5	5,950	0.45

Source: BHP Billiton Annual Report 2014

Table 4.10: Coal Reserves as at 31 December 2014 (adb) in 100 per cent terms

Project	Mining Method	Proved	Probable	Total	Proved Marketable Reserve				Probable Marketable Reserve			
		Mt ROM (adb)	Mt ROM (adb)	Mt ROM (adb)	Mt (adb)	Ash (%)	CV (kcal/ kg)	TS (%)	Mt (adb)	Ash (%)	CV (kcal/ kg)	TS (%)
Wolvekrans	Opencast	382	17	399	268	21.8	6,010	0.47	12	22.5	5,950	0.45
Middelburg	Opencast	94	0	94	78	23.2	5,890	0.47	-	-	-	-
Klipspruit	Opencast	38	0	38	32	23.0	5,800	0.82	-	-	-	-
Khutala	Underground	32	0	32	29	33.6	4,440	0.76	-	-	-	-
	Opencast	0.2	0	0.2	0.2	35.7	4,640	1.15	-	-	-	-
TOTAL		546	17	563	407	23.1	5,840	0.50	12	22.5	5,950	0.45

Source: BHP Billiton Annual Report 2014 and updated in Nov 2014

The relevant thickness and raw coal quality cut-off parameters applied are detailed in Table 4.11.

Table 4.11: Technical cut-off parameters

Deposit	Coal Resources	Coal Reserves
WMC	≥1.0 m seam thickness, ≤45% ash, ≥17.9% volatile matter	≥1.0 m seam thickness, ≤45% ash, ≥17.9% volatile matter, ≥2,870 kcal/kg
Khutala	≥1.0 m seam thickness for OC, ≥2.5 m seam thickness for UG, ≤45% ash, ≥24.0% dry ash-free volatile matter	≥1.0 m seam thickness for OC, ≥3.6 m seam thickness for UG
Klipspruit	≥1.0 m seam thickness for OC, ≤45% ash, ≥24.0% dry ash-free volatile matter	≥1.0 m seam thickness, ≤45% ash, varying ≥3,580 kcal/kg to 4,300 kcal/kg
Weltevreden	≥0.8 m seam thickness for OC, ≤45% ash	-
Leandra North	≥1.8 m seam thickness	-
Leandra South	≥1.8 m seam thickness	-
Naudesbank	Varying ≥0.5 m to 0.8 m seam thickness, ≤45% ash, ≥22.0% dry ash-free volatile matter	-

Source: BHP Billiton Annual Report 2014

Due to the numerous igneous intrusions in the form of dolerite dykes and sills, it is necessary to exclude devolatilised and coked coal areas from Coal Resource estimates, which necessitates a volatile matter cut-off parameter.

With the exception of ash and volatile matter, no other coal quality cut-offs are applied in the estimation of Coal Resources. This is due to the fact the SAEC operates two large wash plant complexes and has market access for a low quality export product (4,800 kcal/kg NAR), as well as the domestic Eskom power generation market.

4.7 Overview of data supporting the estimates

4.7.1 QA/QC procedures

Drilling

Prior to 1994, the two original owning companies, Trans Natal Coal Corporation Ltd and Rand Mines, used their own in-house drill rigs and operators to carry out exploration drilling activities (prior to the amalgamation, Rand Mines comprised the following coal assets; Khutala, Douglas, Middelburg and Majuba). After the amalgamation of the two companies in 1994, exploration and pre-production drilling has been conducted in accordance with SAEC's policies covering exploration procedures and drilling standards, with the drilling carried out by external contractors. The current contractor for all of SAEC's Operations is Zaيمان Exploration Drilling (Pty) Ltd.

The vast majority of all historical, as well as the current drilling, across the operations and the Development Assets comprises diamond core drilling using a TNW double tube core barrel (core diameter 60.3 mm). In some of the deeper areas, a NQ core barrel (core diameter 47.6 mm) was used to facilitate faster core retrieval by means of a wire-line system.

All completed borehole collar positions are appropriately surveyed by certified land or mine surveyors. Borehole collars are surveyed in the LO29 Gauss Conform (Clarke 1880 Spheroid) coordinate system to the Cape Datum (Khutala, Wolvekrans and Middelburg),

and the World Geodetic System 84 (WGS84)(Hartebeesthoek94) Datum (Klipspruit). Klipspruit is the youngest of SAEC's mines, with the mine was established using the WGS84 coordinate system. Survey coordinate information relating to the Development Assets is in Clarke 1880 Spheroid coordinate system referenced to the Cape Datum, except for Weltevreden Coal Resource area, which is WGS84 (Hartebeesthoek94) Datum. Borehole collar elevations are routinely compared against the latest flown digital terrain model ("DTM") topography surfaces to check for consistency of survey data.

All boreholes completed since 2002, with the exception of those drilled through pre-mined pillars, are routinely logged by means of down-hole geophysical sondes. The standard set of parameters measured includes calliper, total gamma, long spaced density and short spaced density. Where required to assist with geotechnical assessment, sonic and neutron sondes are also run.

Coal seam intersections are reconciled against the geophysical logs to standardise roof and floor depths and to ensure that core recovery is appropriately assessed. If required, down-hole depth adjustments are made using the depth adjuster provided in Micromine's GBIS borehole database software. Within a coal seam, a minimum core recovery of 95 per cent by volume is deemed acceptable, failing which, the intersection is re-drilled.

With the exception of preproduction drilling, core is photographed on-site. After boreholes have been logged and sampled, the drill company disposes of the remaining core at a pre-determined site. No core is stored. The coal samples are not cut or sawn and are not pre-treated before submission to the laboratory. Geotechnical logging is completed, if required.

The borehole density (all relevant seams intersected and sampled) covering the longer term mining areas included in LOA plans comprises a spacing of less than 500 m between boreholes, except for Klipspruit South and Wolvekrans, which both have a component of Inferred Resources.

In the short term (1 to 2 years), open pit mining areas, borehole spacing is planned on a 100 m by 100 m grid. This spacing is decreased in areas where known structural complexities occur. In some areas, the borehole spacing may be further reduced to delineate sub-outcrops or dolerite affected devolatilised areas.

Micromine's GBIS Borehole Database version 7.7.1 software is used for the capture, validation and storage of all borehole, geophysical and laboratory analytical data. GBIS provides several basic validation routines that check inputs such as borehole coordinates, lithology 'from' and 'to' depths, unlogged gaps, sample intervals and gaps in analytical results within seams. All operations use an initial Capture Project to capture all new boreholes and to carry out data validation, depth adjustments and the standardisation of analytical washability data. Once data capture is complete and a borehole has been verified, it is moved to the corporate Main Project database.

Further review of coal quality results is performed by means of linear regression analysis in GBIS, particularly for relative density versus ash and calorific value versus ash. Other GBIS coal quality checks include checking the sum of proximate analysis and reviewing ash, volatile and calorific value trends within wash tables.

Sampling and analyses

Prior to 1994, borehole sampling and analytical procedures were carried out in accordance with the policies and standards at the time of Trans Natal Coal Corporation and Rand Mines respectively. After amalgamation of the two companies, sampling and analytical procedures was carried out in accordance with SAEC's policies. Currently, sampling is undertaken in accordance with documented standard procedures.

Sample boundaries are determined visually by experienced staff using changes in coal lithology type as the main guideline. There are also sampling protocols defined for each mine/project that outline the treatment of waste materials (intra- and inter-seam shales and sandstones), recommended minimum and maximum sample widths, the number of roof and floor dilution samples, and the number and type of routine and special analyses that should be carried out for each drilling campaign.

Core samples are collected according to visual lithological criteria and with the aid of geophysical logs, which help detail changes in density. Ranges in sample size (core length) are determined firstly by the minimum mass required for the specified analytical procedures and secondly as a maximum by the seam thickness.

Samples are crushed to -25 mm and the -0.5 mm fine fraction screened out and submitted for raw coal analysis. The -25 +0.5 mm coarse fraction is subjected to float/sink analysis at an appropriate range of densities, each fraction is routinely analysed for proximate analysis, total sulphur and calorific value, and reported on an air-dried basis. The following ranges of float/sink densities are routinely analysed at the operations:

- Wolvekrans: 1.35, 1.40, 1.50, 1.60, 1.70, 1.80, Sinks 1.80
- Middelburg: 1.35, 1.40, 1.50, 1.55, 1.60, 1.70, 1.75, Sinks 1.75
- Klipspruit: 1.40, 1.50, 1.60, 1.70, 1.80, 2.00, Sinks 2.00
- Khutala (since 2007): 1.35, 1.40, 1.50, 1.60, 1.70, 1.80, Sinks 1.80

The following sample and special analysis guidelines are applied at all operations:

- Minimum TNW core length of 0.3 m for raw coal analysis.
- Minimum TNW core length of 0.5 m for float/sink analysis.
- Maximum TNW core length of 3 m.
- For new areas, 5 per cent of the boreholes should be selected for "Eskom-type" special analyses (abrasives index YGP, hardgrove grindability index, ash fusion temperatures – initial, softening, hemispherical and flow (all under reducing conditions) on the middling product composites for cumulative float density 1.80 to 1.50 or 1.80 to 1.55, depending on the washability characteristics.
- As per above, a selection is also made of boreholes for special analyses of a primary product at a cumulative floats density of 1.50 or 1.55 for No.4U, No.4L, No.2A and No.2 Seams. In addition to the above mentioned specials, the following are also carried out; forms of sulphur, forms of silica, ultimate analysis, ash constituents (major element oxides), phosphorous in coal and a selection of trace elements.
- All special analyses are performed on recombined composite samples for the full seam on an undiluted basis.
- All intra-seam non-coal parting material is sampled and analysed and included in seam composites. No sampling protocol exists for the inclusion or exclusion of inter-seam parting material.

Analytical Standards and verification

Prior to 2012 samples were analysed at SAEC's in-house coal laboratory at Middelburg. Since then, the analysis of all exploration derived coal samples has been carried out by the coal laboratories of SGS South Africa (Pty) Ltd ("SGS"). SGS are ISO9001, ISO14001 and ISO17025 accredited. In order to comply with the principles of ISO17025, all work is carried out according to appropriately documented and approved procedures that ensure traceability to certified international standards. All instruments and procedures are calibrated with standard reference materials linked to international standards. Various in-house standards, or secondary standards, of known value are also analysed at periodic intervals amongst samples for quality assurance/quality control ("QA/QC") purposes as

prescribed in the relevant procedures. Coal samples are analysed in duplicate and reference materials are routinely analysed every tenth sample.

All balances, scales, ovens and furnaces are calibrated every six months by an accredited supplier.

The following key sample preparation and analytical standards are applied:

- Sample Preparation CM-ZA-[MIN]-(TRI) TE-004 (Based on 13909 part4)
- Size analyses by sieving CM-ZA-[MIN]-(TRI) TE-005 (Based On ISO 1953:1994)
- Total Moisture CM-ZA-[MIN]-(TRI) TE-006 (Based On ISO 589:2008)
- Ash Content CM-ZA-[MIN]-(TRI) TE-007 (Based On ISO 1171:2010)
- Volatile Matter CM-ZA-[MIN]-(TRI) TE-008 (Based On ISO 526:2010)
- Moisture in analyses sample CM-ZA-[MIN]-(TRI) TE-009 (Based On ISO 11722:1999)
- Calorific Value CM-ZA-[MIN]-(TRI) TE-010 (Based On ISO 1928:2009)
- Total Sulphur CM-ZA-[MIN]-(TRI) TE-011 (Based On ISO ASTM D4329-5 Method B)
- Ash Fusion Temperatures CM-ZA-[MIN]-(TRI) TE-012 (Based On ISO 540:1995)
- Relative Density is reported as Apparent Density.

SGS participates in a monthly round robin testing scheme called Laboratory Quality Service International ("LQSI") where random samples are analysed and Z-Scores are determined to measure the relative accuracy of certain parameters against other laboratories in the industry. Z-scores track the difference between the laboratory value and the group mean value in terms of the number of standard deviations from the group mean. SGS coal laboratories consistently return Z-Scores within industry accepted limits.

A service level agreement is in place with SGS to store all of the raw coal sample and washed fraction residues (pulverised coal, bottled and ladled) in a controlled environment for a period of three months. As a further QA measure, each operation submits a repeat analyses request for all raw or washed fractions from at least two boreholes per month.

SGS coal laboratories are South African National Accreditation System ("SANAS") ISO17025 certified. The certification audit took place in February 2014.

4.7.2 Coal Resource estimation

Modelling methodology

On completion of all GBIS checks and data validation procedures the following steps are carried out to assess borehole suitability to proceed to the geological modelling stage:

- GBIS cross-sections are drawn to confirm seam/ply correlations and to check for anomalous data.
- Data exports from the GBIS database are checked to confirm the consistency of the data by doing 'sort exercises' on each of the data parameters (thickness, calorific value, ash etc.).
- Once the data exports have been loaded into the geological modelling software, data is again subjected to a series of validation routines.

The geological models are developed using GEMCOM's Minex Horizon (Version 6 and later), geological modelling software designed specifically for stratigraphic type layered deposits. Geological modelling is done in accordance with the SAEC standard Geology Policy and Procedures and as recommended by Gemecs (Pty) Ltd, a consultancy and agent for the Minex geological modelling software.

The model generation process includes the following general steps:

- Verification of data in the GBIS database and export of borehole data to be used in Minex

- Validation of data in Minex, e.g. correct stratigraphic sequence, negative seam thicknesses, seam statistics, coal quality statistics)
- Run the Missing Seam Interpolator (Interpolation of all missing seams that are absent and not intersected in boreholes and setting these interpolated missing seam thicknesses to zero, in order that they are not modelled).
- Washable simulations in Minex to simulated theoretical primary and secondary coal products to assist with product selection for long term planning.
- Build topographic model and check borehole collars against the topographic model surface. Topographic models are generated from the latest flown DTM data. The latest DTM data acquisition was by Southern Mapping (Pty) Ltd as listed:
 - Wolvekrans – BMK & DRF Model: October 2011, VDD: Aug 2013
 - Middelburg - July 2009
 - Klipspruit – April 2013
 - Khutala – November 2013
- Build the seam and coal quality grids. Grids are generated for all relevant data parameters using the Minex “Growth” or “General Purpose” gridding algorithm, with the grid cell size usually set at 50 m by 50 m. This gridding algorithm is unique to Minex, but is well known and accepted within the coal resource industry.
- Seams are then truncated by the weathering, topography surfaces, and in some instances by basement geology palaeo-highs.
- In-situ density is modelled by gridding the loaded borehole apparent density values. The air-dried moisture is fairly consistent across the operations and is typically low as is the case with most South African coals. Analyses of Equilibrium Moisture and Moisture Holding Capacity are not routinely available and are rare. The density data collected within SAEC over historical and recent exploration campaigns is comprised of apparent density measurements and is assumed to be representative of in-situ density for resource tonnage estimates. Crushed coal pycnometer density measurements are not routinely performed and no moisture adjustments are made for in-situ density.
- Sets of resource polygons are developed on a per seam basis by applying the relevant technical cut-off parameters and limiting factors. Coal Resources are estimated and classified within the resource polygons and accumulated to an appropriate reporting level.
- As a corporate standard, SAEC follows the guidelines set out in the 2012 Edition of the JORC Code when estimating and reporting Coal Resources.
- Apart from the basic environmental, tenement boundary, coal quality and seam thickness cut-offs, no other cut-offs are applied in Coal Resource estimation. In particular, no economic or financial factors, or strip ratio cut-offs in the case of opencast potential are applied at the resources estimation stage. As a result, it is Xstract’s opinion that when considering “reasonable prospects for eventual economic extraction”, this probably leads to an over estimation of the stated Coal Resources, particularly at the Development Assets. In the case of Development Assets, this has no affect on SAEC’s declared Coal Reserve base, which is confined to its current operations. Coal Resources, both within the Development Assets and within the current Mining Assets, are continually re-evaluated as new drilling information becomes available, and more detailed techno-economic studies and mine plans are completed.

Resource classification

The confidence levels of Coal Resources pertaining to the operations were classified according to a set of radii of influence criteria around points of observation. A point of observation is define as a cored borehole with associated down hole geophysical profiles and composited seam washability data, or raw coal quality data in the case of Khutala.

Distance grids were produced depicting radii of influence around points of observation based on the following criteria:

- Eight points of observation per 100 ha for Measured Coal Resources (or up to 199 m radius)
- Four points of observation per 100 ha for Indicated Coal Resources (or 200 to 282 m radius)
- One point of observation per 100 ha for Inferred Coal Resources (or 283 to 564 m radius).

The radii of influence used for this classification are very similar to those recommended as a maximum by the SANS 2004 Coal Guidelines.

The above set of classification criteria are applied to all Coal Resource estimates across the assets regardless of changes in coal quality characteristics or structural complexity. However, given the generally high density of cored boreholes this is unlikely to present a material risk to the resource classification.

Accuracy of the geological model

The pre-production objective on SAEC's opencast operations is to have at least one borehole per 100 m by 45 m mining block for planning purposes, generally achieved over a two year rolling budget period. Experience has shown that this provides good control of coal quality, depth and thickness parameters.

Reconciliations and comparisons form the basis of establishing the relative accuracy of the resource estimates on all opencast operations. For thickness and tonnes comparisons, geophysical logs from pre-split blast holes are used to assess the effectiveness and accuracy of the geological model to determine the Coal Resource and to provide a robust platform for mine planning.

The pre-split holes are drilled 20 m apart on the edges of blocks. The interpreted geophysical profiles obtained from these holes are then compared to data in the exploration database and geological model retrospectively. These comparisons have shown an accuracy percentage of above 90 per cent in terms of thickness and tonnes over the past year on all operations.

4.7.3 Justification of Modifying Factors

SAEC follows a logical process, outlined below, leading from drilling to laboratory analysis, and the conversion of theoretical yields to practical yields for coal product definition and marketable reserve estimation:

- The coal components of the sampled drill core are sent to the laboratory for full coal quality analysis
- Washability tests are then conducted on each coal seam composite and theoretical washables and curves produced
- All of these quality parameters are modelled as part of the resource modelling process
- These wash curves, as well as the other quality data, are built into the reserve model
- SAEC makes use of a Coal Allocation Simulation Application that takes washability or product data from the geological model and the scheduling model on an air dried, theoretical, borehole basis, and adjusts for plant efficiency, losses and dilution, resulting in practical yields. In addition, adjustments are made from the Process Design Criteria. The Coal Allocation Model will beneficiate coal at a specified float density. Coal is allocated to the best destination within the constraints specified, and simulated products are blended to obtain saleable domestic and export products

- Actual performance (included yields) against plan is monitored on an ongoing basis and formally reported through the F1, F2 and F3 reconciliation process
- Any material deviation from expected yield is reviewed to determine the root cause and can result in adjustments to modifying factors

Xstract considered the reconciliation data provided by SAEC to demonstrate the appropriateness of the technical modifying factors such as practical yield, coal product quality, dilution, and losses. Table 4.12 shows the reconciliation factors largely fall within the tolerance limits of ± 10 per cent on an annual basis and Xstract is of the opinion that the modifying factors are appropriate in the estimation of the Reserves.

The conversion from ROM to Marketable Coal Reserves is based on historical practical yield data from the operating coal processing plants and reconciliation confirms these factors to be appropriate.

Table 4.12: Reserve reconciliation table for periods

Operation			Year	F1 (Tonnage Factor)					F2 (Processing Factor)					F3 (Marketable Factor)				
				Tonnes	Ash	CV	Vm	S	Tonnes	Ash	CV	Vm	S	Tonnes	Ash	CV	Vm	S
Khutala	1-Jul-13	31-Dec-13	2014	97%	100%	100%	100%		95%	105%	97%	99%		99%	105%	97%	99%	
Klipspruit	1-Jul-13	31-Dec-13		96%	100%	100%	100%	100%	109%	106%	91%	95%	106%	107%	104%	97%	93%	109%
Middelburg	1-Jul-13	31-Dec-13		96%	100%	100%	100%	100%	113%	75%	87%	100%	60%	103%	99%	101%	100%	90%
Wolvekrans	1-Jul-13	31-Dec-13		96%	100%	100%	100%	100%	113%	133%	87%	100%	165%	103%	99%	101%	100%	90%
Khutala	1-Jul-12	31-Mar-13	2013	97%	100%	100%	100%		98%	94%	105%	103%		100%	94%	105%	103%	
Klipspruit	1-Jul-12	28-Feb-13		100%	100%	100%	101%	96%	106%	112%	104%	103%	72%	91%	106%	100%	100%	87%
Middelburg	1-Jul-12	29-Jan-13		99%	100%	100%	100%		103%	106%	99%			105%	95%			
Wolvekrans	1-Jul-12	31-Mar-13		93%	87%	106%			105%	106%	99%			105%	95%			
Khutala	1-Jul-11	30-Jun-12	2012	100%	99%	101%	101%	101%	100%	93%	106%	103%	84%	99%	91%	105%	102%	84%
Klipspruit	1-Jul-11	1-Dec-11		100%	99%	101%	100%	100%	97%	102%	97%	99%	67%	97%	76%	101%	101%	42%
Middelburg	1-Oct-11	31-Dec-11		100%	100%	100%	100%	100%	100%	102%	98%	99%	98%	95%	71%	107%	99%	49%
Wolvekrans	1-Oct-11	31-Dec-11		100%	100%	100%	100%	100%	101%	92%	88%	89%	89%	95%	65%	87%	77%	44%
Khutala	1-Jul-10	30-Jun-11	2011	100%	98%	102%	102%	106%	100%	96%	103%	98%	76%	100%	92%	105%	101%	81%
Klipspruit	1-Jul-10	30-Dec-10		100%	100%	100%	100%	100%	99%	98%	99%	100%	55%	107%	92%	103%	108%	41%
Middelburg	1-Jul-10	31-Dec-10		100%	100%	100%	100%	100%	88%	88%	87%	87%	88%	100%	81%	111%	108%	64%
Wolvekrans	1-Jul-10	31-Dec-10		100%	100%	100%	100%	100%	103%	97%	96%	96%	96%	103%	108%	91%	87%	70%
Khutala	1-Jul-09	30-Jun-10	2010	99%	106%	96%	94%	101%										
Klipspruit	1-Jan-09	30-Dec-09		100%	100%	100%	100%	100%	104%	99%	105%	99%	64%	102%	87%	99%	99%	61%
Middelburg				100%	100%	100%	100%		97%	78%	80%	80%		104%	74%	83%	81%	

Source: SAEC

5 Mining assets

5.1 Introduction

Within the Witbank Coalfield, SAEC has its granted New Order Mining Rights grouped together into three Projects, namely the Wolvekrans-Middelburg Complex, the Klipspruit Mine and the Khutala Mine.

5.2 Wolvekrans-Middelburg Complex

The WMC is an opencast bituminous coal mining and processing operation situated in the Witbank Coalfield. The complex is split into three main operating entities, namely:

- Wolvekrans Mine located in the south of the complex at approximately latitude 26°4'58" South and longitude 29°17'0" East and covering the Albion, Vandyksdrift, Steenkoolspruit, Driefontein, Boschmanskrans and Deep Far South sections;
- Middelburg Mine located in the north of the Complex at approximately latitude 25°53'58" South and longitude 29°27'38" East and covering the Hartebeestfontein, Klipfontein and Goedehoop sections; and
- SAEC Coal Processing ("BCP") focusing on five beneficiation plants – North Export Plant, North Middlings Plant, South Eskom Plant, South Export Plant and VDD mobile crusher (Figure 5.1).

The WMC is easily accessible along public roads, with the R35 and R575 providing access to the Middelburg Mine and North Plant, while the R544 and R547 provide access to the Wolvekrans Mine and South Plants. The nearest towns are Witbank and Middelburg, some 20 to 30 km north and northeast of the Complex.

Figure 5.1: Overview of the Wolvekrans-Middelburg Complex

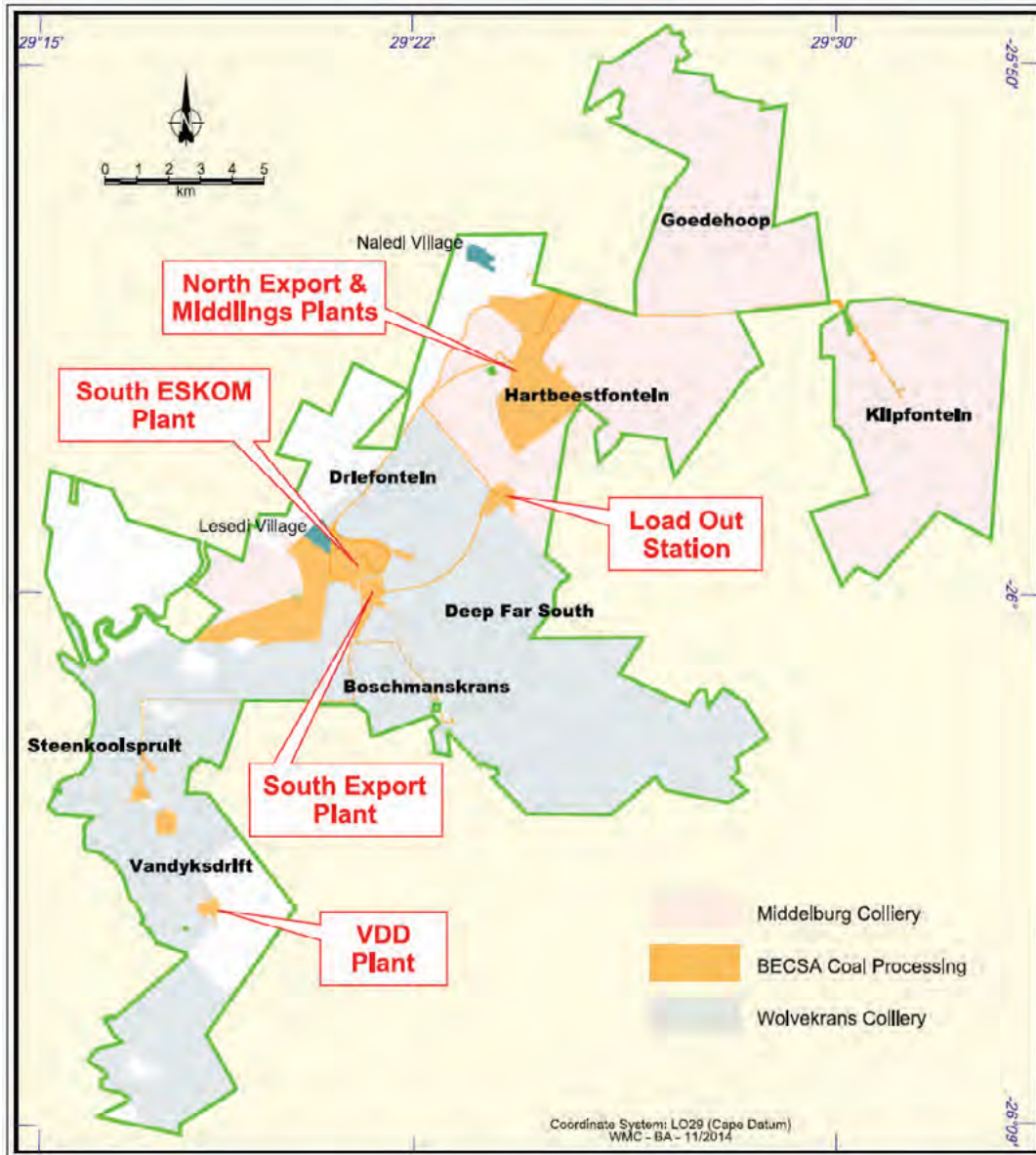

Source: SAEC

5.2.1 Land tenure

SAEC and Tavistock Collieries (Pty) Limited ("Tavistock"), an affiliated company of Xstrata South Africa (Pty) Ltd, are joint holders of three Converted Mining Rights in the previous joint venture ratio (SAEC 84:16 Tavistock). In addition, SAEC holds a 100 per cent interest in the Wolvekrans (Albion) Mining Right (DMR Reference MP30/5/1/2/2/377 MR). These Mining Rights were converted during October and December 2011.

All four Rights comprise the WMC, which includes the Wolvekrans and Middelburg Mines and excludes the portion Tavistock obtained as a result of the 2008 amendment of the Douglas-Tavistock JV agreement. Under this amendment, the mining area has been divided into an area wholly owned and operated by Tavistock and an area wholly owned and operated by SAEC. Applications were made in December 2008 to the Department of Mineral

Resources to amend the Mining Rights but a date for execution has not yet been provided. Ministerial consent to amend the Mining Rights has been granted.

The ownership, farm properties, surface rights and mineral rights, which comprise the WMC and its related legal tenure are summarised in Figure 5.2, Figure 5.3, Table 4.3 and Appendix B. With the exception of the Albion, and VS areas, the mineral and surface access rights held by SAEC are sufficient for all aspects of the mining and processing operation. The Albion, VS and DW rights are the subject of on-going negotiations.

Figure 5.2: Current and Previous Mining Areas at the Wolvekrans Mine

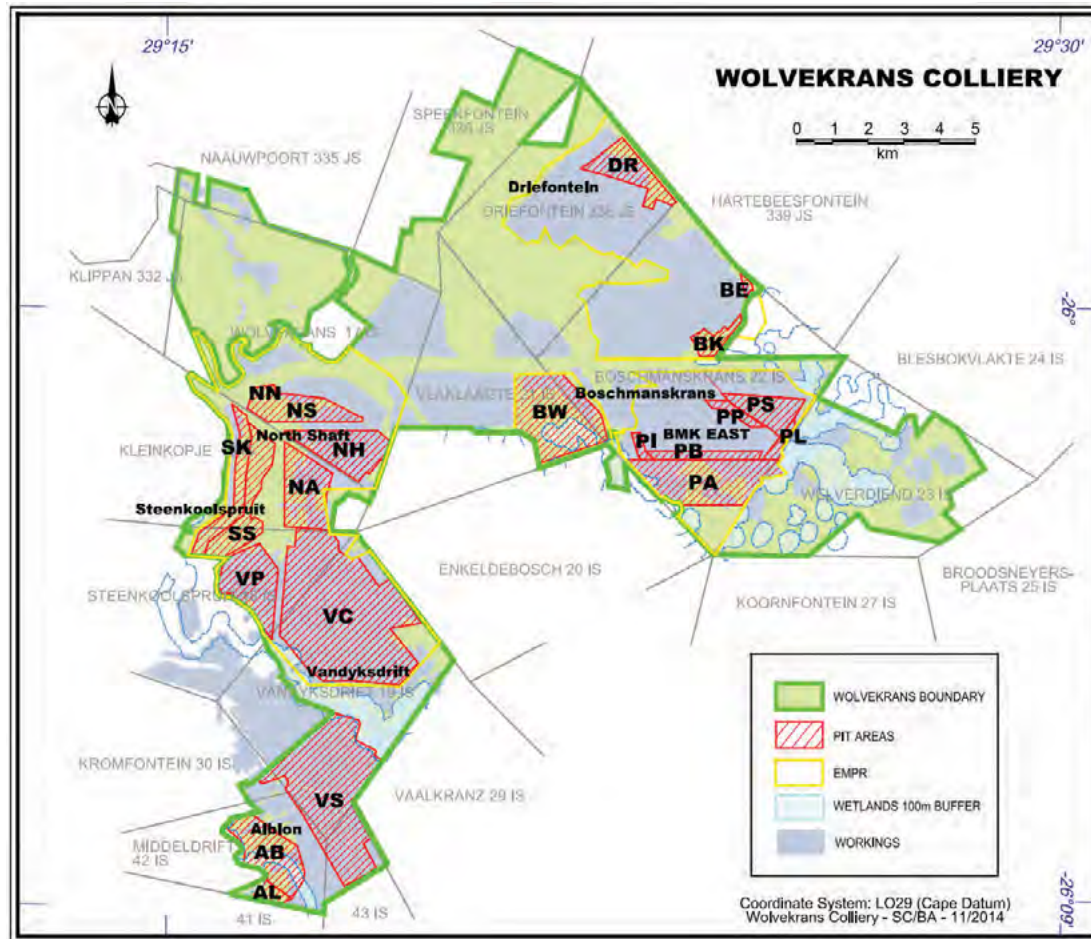

Source: SAEC

Figure 5.3: Current and Previous Mining Areas at the Middelburg Mine

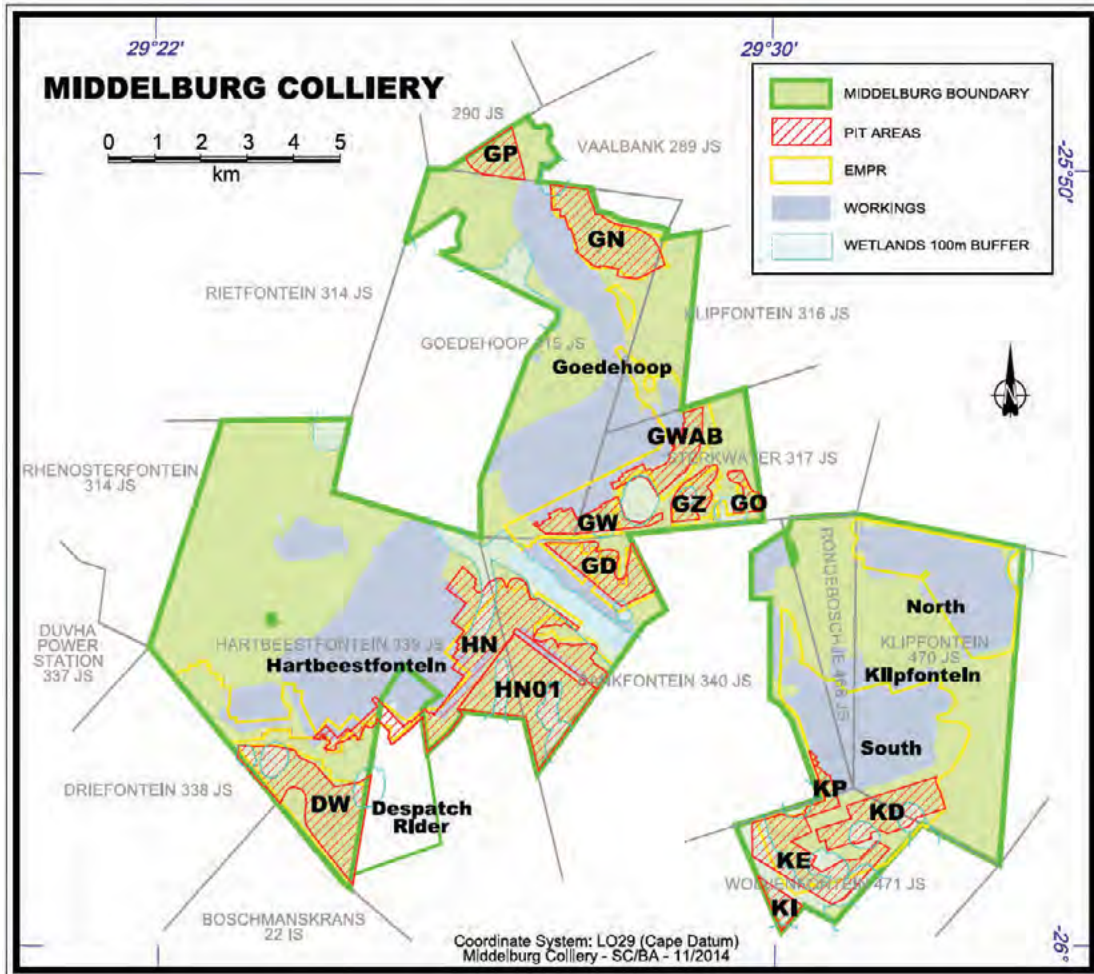

Source: SAEC

5.2.2 Material contracts

There is a long-term fixed price, guaranteed volume (10 Mtpa) contract with Eskom, for the supply of coal from Wolvekran and Middelburg to the nearby Duvha Power Station. The current contract is valid to 2024, with a further 10-year option. While SAEC has the obligation to supply 10 Mtpa, Glencore is responsible for coal supply of 1.5 Mtpa of this obligation. The terms of the contract remain confidential, however the price achieved reflects a base price escalated to reflect certain costs and inflation indices. Having discussed this contract with SAEC, Xstrat considers the terms of the agreement are appropriately reflected in SAEC's long-term plans. As part of this coal supply agreement, Eskom own a calculated share of the environmental liability within certain areas of the mine (i.e. the Driefontein area).

SAEC holds a rail entitlement with TFR in line with their equity interest in the RCBT, currently 21 per cent based on a current capacity of 81 Mtpa. SAEC and TFR recently agreed terms for a 10-year take or pay contract, with TFR to transport coal by rail from BCP and Klipspruit to Richards Bay. Under the contract, the price is fixed with annual escalations, which are subject to review under an established mechanism.

SAEC has entered into mining contracts for the removal of overburden and pre-stripping at WMC. SAEC is also moving towards contractor mining for smaller pits.

Fraser Alexander Pty Ltd holds the operating contract for the VDD plant, which is currently being expanded from 1.2 to 2.4 Mtpa operation.

SAEC also hold a contract with Stefanulti Stocks Pty Ltd for the cleanout and transportation of tailings in the tailings cells at the Southern BCP plant.

5.2.3 History

Ownership

The current configuration of the WMC is the result of a series of mergers and the acquisition of various separate collieries (Albion, Vandykesdrift, Boschmanskrans, Driefontein, Steenkoolspruit, Douglas, Wolvekrans, Goedeheop, Hartebeestfontein and Klipfontein) over an extended history. This has involved multiple changes of ownership including holdings by Witbank Collieries Limited, TC Lands, Anglo-Transvaal Collieries, Barlow Rand Group, Rand Mines/Randcoal, Shell, BP, JCI, Gencor, ICC, Ingwe, Billiton International and BHP Billiton. SAEC currently owns a 100 per cent interest and operates the WMC.

Project development

The Witbank Coalfield was initially developed in the 1890s, in response to the discovery of gold on the Witwatersrand and the resultant demand for coal. By 1889, at least four collieries; Brugspruit Adit, Maggies Mine (Vandyksdrift), Steenkoolspruit and Douglas Mine, were operating in the Middelburg-Witbank district (Chadwick, 1982, Falconer, 1990).

In 1973, Witbank Mine Limited ("WitCol", subsequently Randcoal) consolidated a number of smaller collieries in the Witbank-Middelburg area through the acquisition of:

- the Douglas and Vandyksdrift Collieries from a subsidiary of TC Lands;
- the entire issued capital of Albion Collieries, the Black Diamond Mine, Consolidated Marsfield Collieries, Minaar-Witbank Mine and Union Collieries; and
- various coal, mineral and surface rights from Anglo-Transvaal Collieries.

While small-scale mining had occurred at various locations at the Douglas Mine since 1896, it was not until 1976 that significant operations were commissioned.

While Middelburg had been in production up until the 1947, when it was closed following a combustion incident. The mine was reopened in 1982 to extract a smaller section producing export quality coals. This section was later expanded to encompass the Hartebeestfontein, Bankfontein and Goedeheop sections.

In 1991, the Vandyksdrift North area was opened up with the installation of a shaft system to exploit the No.2 and No.4 Seams, with coal transported to the Vandyksdrift ("VDD") plant by overland conveyor.

In January 1995, Middelburg was amalgamated with the adjacent Duvha Mine after the formation of ICC to become Middelburg Mines. Duvha had commenced mining in 1979 producing coal solely for Eskom's Duvha Power Station.

A prefeasibility study for the development of Boschmanskrans was initiated in 1995 and completed in 1999. Opencast mining of the remnant pillars in the area commenced in January 2000.

In 2003, the opencast section of Douglas Mine (Boschmanskrans Pillar section) was incorporated into Middelburg Mine. In 2004, the Douglas Middelburg Optimisation ("DMO")

Project was commissioned to address the optimisation of the predominantly underground export quality coals at Douglas with the opencast coals produced at Middelburg. The DMO project included design and construction of raw coal handling and coal preparation plant and slimes, along with product handling facilities.

The underground section of Douglas Mine was terminated in November 2008 at depletion of the underground reserves. Middelburg Mine Services and Douglas Mine merged during 2008, as part of the Douglas Middelburg Optimisation Project to exploit the remaining available opencast reserves.

In April 2010, the Middelburg Mine was divided into the Middelburg and Wolvekrans Collieries and SAEC Coal Processing.

Recent production history from WMC is discussed in Section 5.2.7.

5.2.4 Local geology

Introduction

The WMC lies in the northwest of the Witbank Coalfield. The general stratigraphy and disposition of coal seams of the Witbank Coalfield is presented in Figure 5.4.

Figure 5.4: Typical stratigraphy of the Witbank Coalfield

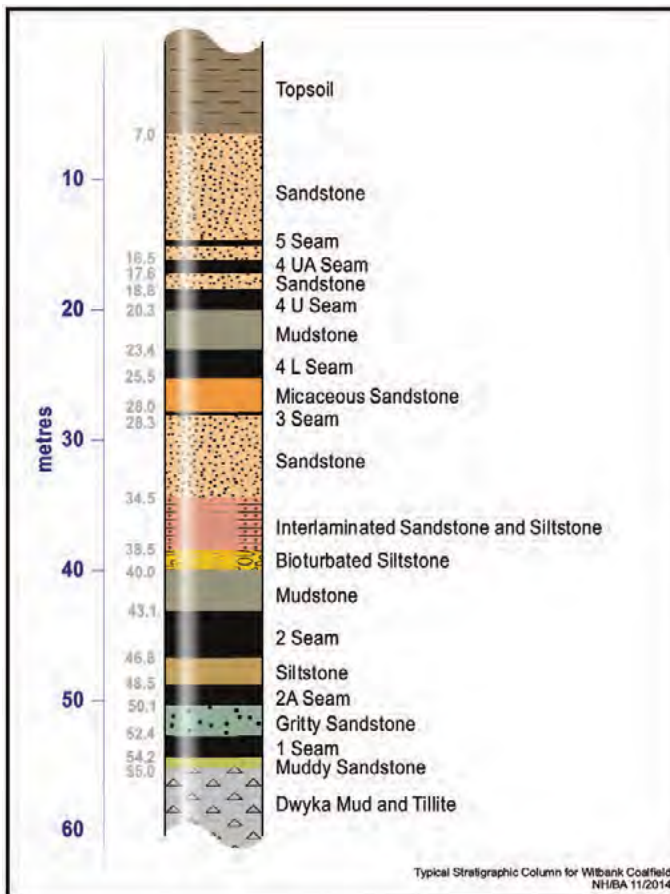

Source: SAEC

During the early Permian period, thick coal deposits were formed in the deeper parts of the Karoo Basin with the seams thinning rapidly and pinching out against sub-basin margins and against major basement palaeo-high features. The uppermost coal seams are often lost to erosion, and where present they usually sub-outcrop against the base of weathering surface. These seams show less continuity in lateral extent and thickness than the lower seams.

Wolvekrans

In the Wolvekrans area, sandstone filled fluvial channels are prominent below the No.5 Seam through to the No.2 Seam. In the Douglas area, a prominent fluvial sandstone channel is developed between No.2 Seam and No.2A Seam. Running in a north south direction it has affected the remaining No.2 Seam resource in the Douglas mining area. The No.2 Seam is generally thinner along the channel and intra-seam partings affect coal quality in the channel-affected area. The extent of this prominent sandstone channel is shown in Figure 5.5.

Figure 5.5: Distribution and thickness of prominent sandstone channel at Wolvekrans – legend shows interburden thickness between No.2 Seam and No.2A Seam in metres

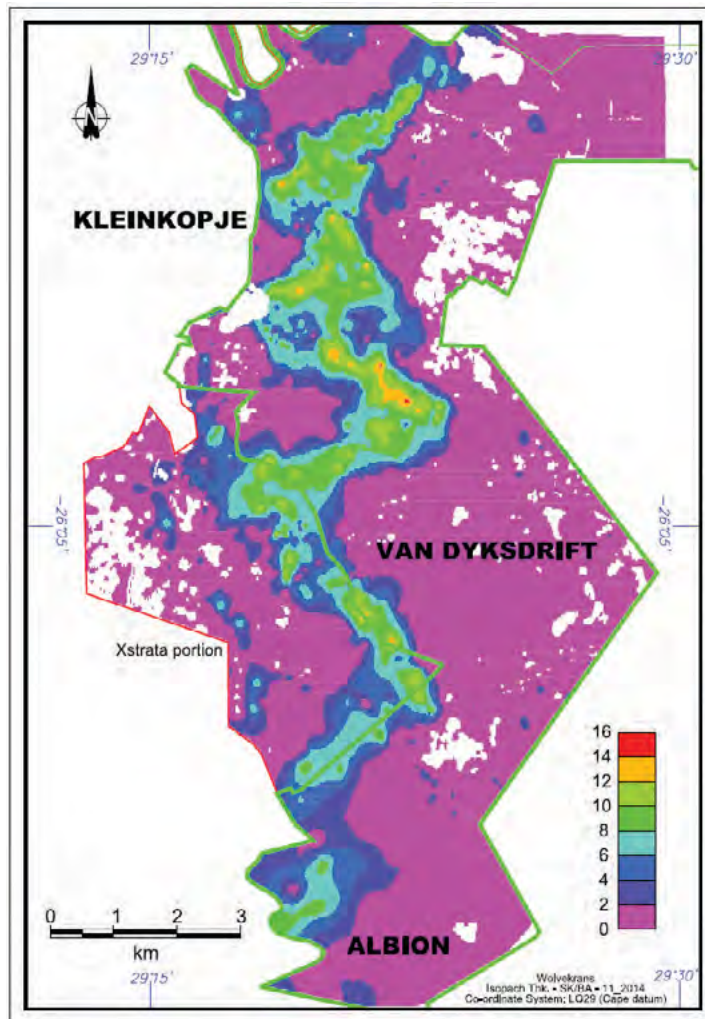

Source: SAEC

Coal seams at WMC are associated with glacio-fluvial and upper deltaic plain sedimentation. The main seams of economic importance include the No.4L, No.2 and No.1 Seams, which are generally thick and laterally continuous.

No.5 Seam (0 to 2 m) is the uppermost seam and is discontinuous mainly due to weathering. The relatively thin No.5 Seam was deposited during a short period of peat accumulation in a relatively unstable basin. The seam is of good coal quality but often friable. The average thickness were fully developed ranges between 1.5 m and 2.0 m. Only isolated small areas remain at Wolvekrans where the No.5 Seam is adequately developed to be considered for mining.

No.4L Seam (0.5 to 5 m) is present across most of the WMV area and is overlain by two lesser seams, firstly the poor quality No.4U Seam (No.4U excluded from Coal Resources), and secondly the good quality but thin No.4UA Seam. The No.4L Seam follows the No.2 Seam in economic importance at Wolvekrans. The No.4L Seam is mined in all the pits at Wolvekrans. Historically, the No.4L Seam was mined underground in some parts of the Wolvekrans.

No.3 Seam (0 to 1 m) is thin and erratically developed. The No.3 Seam is good quality but due to its thickness and erratic development it is uneconomic and not mined at Wolvekrans.

No.2 Seam (3 to 8 m) occurs throughout the Wolvekrans area with thicknesses greater than 3 m. In general, the sediments above the coal seams tend to be fine grained to argillaceous, and carbonaceous in places, and usually show an upward coarsening texture with increasing distance above the seam. A marker horizon of bioturbated siltstone is present above the No.2 Seam. In some areas, intra-seam partings are developed which result in the development of a No.2L seam split.

The No.2 Seam shows zoned coal quality variation in the vertical sense with higher and lower yielding zones developed. These quality differences led to the selective mining of the seam in historical underground mined areas of the No.2 Seam across most of Wolvekrans.

To accommodate this historical underground mining practice at Wolvekrans, the No.2 Seam is divided into three separate contiguous plies, namely; No.2R (roof), No.2P (pillars) and No.2B (bottom). This is illustrated in Figure 5.6.

- No.2R (No.2 Roof): No.2 Seam remaining in-situ in the roof during board and pillar mining (100 per cent remains)
- No.2P (No.2 Pillars): No.2 Seam mining horizon remaining as pillars after board and pillar mining
- No.2B (No.2 Bottom): No.2 Seam remaining in-situ in the floor during board and pillar mining (100 per cent remains).

Figure 5.6: Selective underground mining of the No.2 Seam at Wolvekrans

No.2 Seam	
Roof Coal: S2R(~1 m)	100% unmined
Pillar Horizon: S2P (~3.5 m)	70% mined 30% unmined
Bottom Coal	100% unmined

No.1 Seam (0 to 3 m) is the oldest of the coal seams and was deposited on the diamictite/tillite facies, which unconformably overlies the pre-Karoo basin floor, or directly onto the basin floor itself. It is relatively uniform but is variable in thickness. The coal is

generally dull, with a tendency to form a cubic fracture. The No.1 Seam was also historically mined underground in some parts of the Wolvekrans.

Intra-seam partings are present in all coal seams and may comprise different lithologies including sandstone, siltstone and mudstone. They form discontinuous layers and lenses at different heights within seams and are discontinuous. They vary in size and shape and are difficult to predict and correlate.

Intrusives and faulting

Numerous dolerite sills and dykes of Jurassic age intrude the Karoo sediments. Where sills transgress the strata, including coal seams, they have the effect of uplifting the overlying strata, giving rise to complicated structural configurations. These uplifted blocks give the appearance of being fault bounded due to the vertical displacement caused by the sill transgression. Coal adjacent to and along dolerite intersections is subject to burning and de-volatilisation.

A major linear intrusive structure, known as the Ogies Dyke, strikes east-west across the northern boundary of the Boschmanskrans ("BMK") resource area. A graben feature runs parallel to the Ogies Dyke, but will not influence future mining operations.

A large sill structure occurs to the south of BMK East and has devolatilised large areas of the No.2 Seam, as well as lesser amounts of the No.4L Seam. The central resource area within the structure forms an isolated Main uplifted block, as illustrated in Figure 5.7 and the cross-section in Figure 5.8.

Figure 5.7: Main structural features in BMK East area

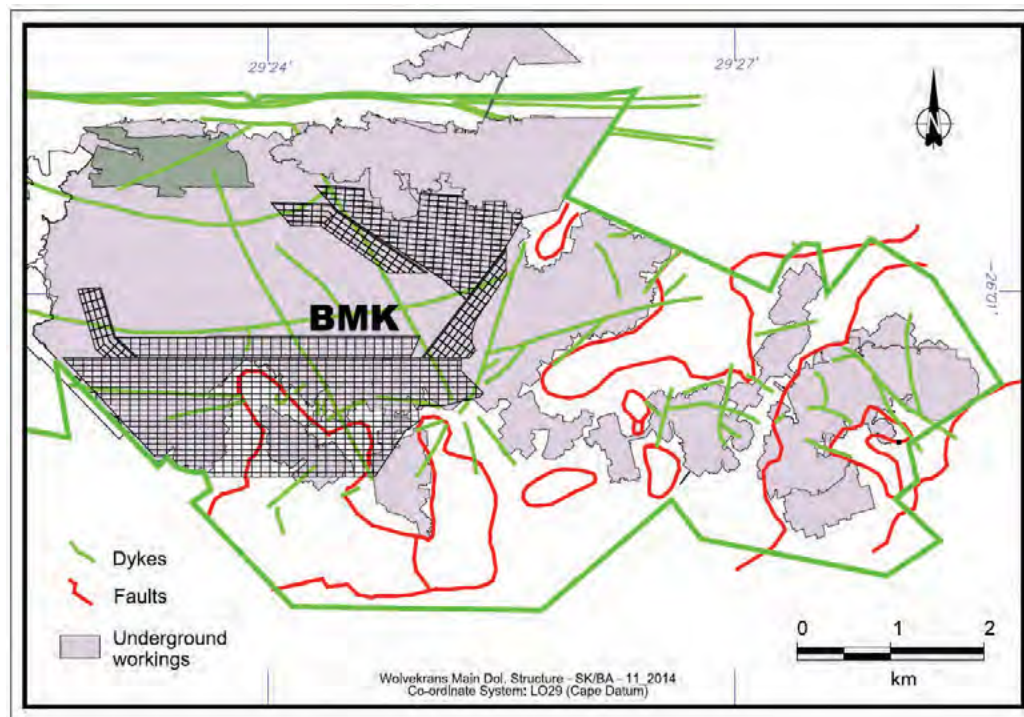

Source: SAEC

Figure 5.8: East west cross-section through BMK East

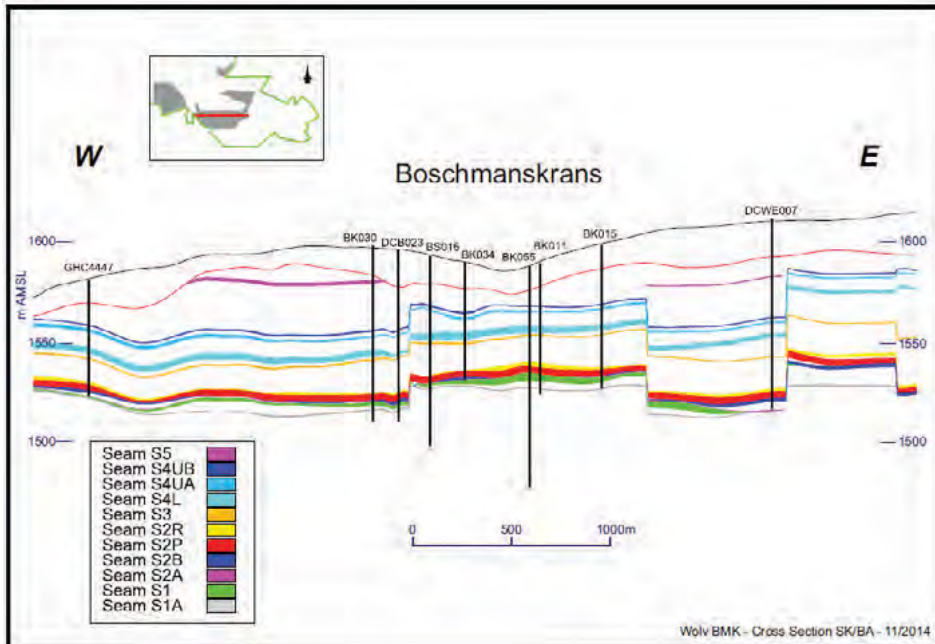

Source: SAEC

The Steenkoolspruit pit area appears to be free of any major igneous intrusions. This area comprises virgin coal seams unaffected by historical underground mining. The coal seams however show significant roll structures where gradients may exceed 10 per cent, and variation in inter-burden thickness due to channel sandstones between the No.2 and No.2A Seams, as illustrated in Figure 5.9. The No.2 Seam also contains numerous intra-seam partings.

Figure 5.9: Cross-section through Steenkoolspruit pit

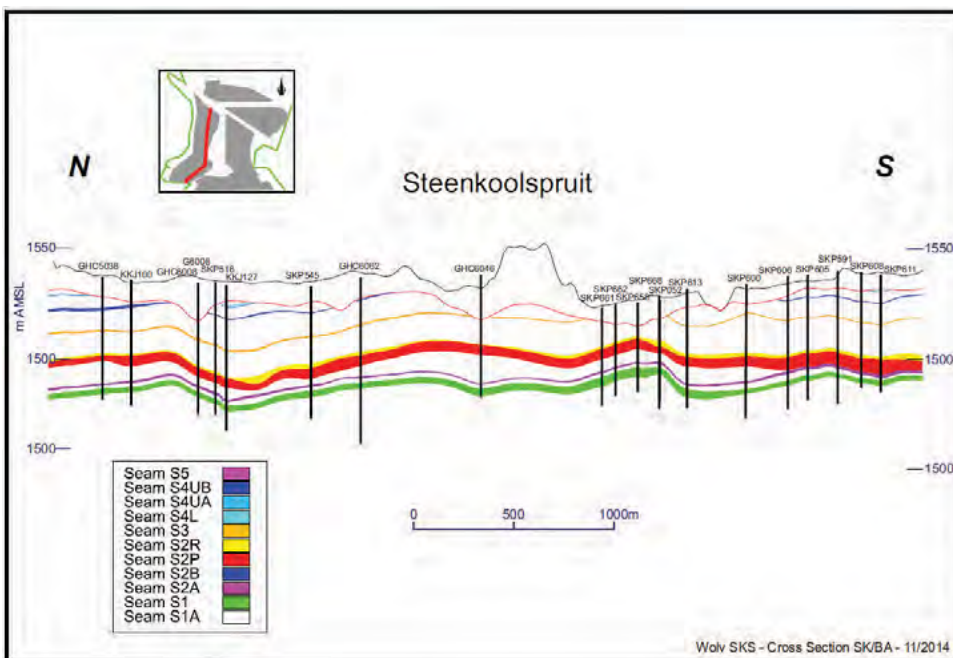

Source: SAEC

Dolerite sill intrusions are also present in the VanDyksdrift Central area where they have resulted in uplifted blocks and devolatilisation of adjacent coal seams. This uplifted area is excluded from the currently defined Coal Resource.

Faulting is generally minor with throws of less than 3 m. Fault planes are near vertical and easily negotiated in opencast operations. The majority of faults are associated with either dolerite intrusions, displacements in the graben structure, and along pre-Karoo ridge features. The only prominent faults at Wolvekrans are those associated with significant dolerite sill emplacement at Vandyksdrift Central and at BMK East.

While faults are rare and in most cases insignificant, seam floor rolls do occur and in places steep gradients require an adaption of the mine plan.

Middelburg

Coal seams preserved in the Middelburg area include the No.5, No.4UA, No.4U, No.4L, No.3, No.2U, No.2, No.2L, No.2A, No.1 and No.1A Seams, and are similar to the seams present at Wolvekrans. The main economic seams across the Middelburg mining area include No.1, No.2A, No.2 and No.4L Seams.

A recent attempt was made to mine both the No.4U and No.4UA Seams in some areas. Seams currently being mined in the Hartbeestfontein area include No.2A, No.2, No.4L and No.4U, and in the Klipfontein area, the No.4L, No.2 and No.4UA Seams are mined. Consequently, the No.4U and No.4UA Seams have been included in the 30 June 2014 statement of Coal Resources.

The numerous intra-seam partings are comprised of sandstone, mudstone and siltstone and form discontinuous layers and lenses at different heights within seams. They vary in size and shape and are difficult to predict and correlate.

Klipfontein South is known to host numerous dolerite dykes and sills. Figure 5.10 shows the effect of a sill on the volatiles content of the No.2 Seam in the Klipfontein pit.

Figure 5.10: Devolatilisation of No.2 Seam by dolerite sill at Klipfontein pit

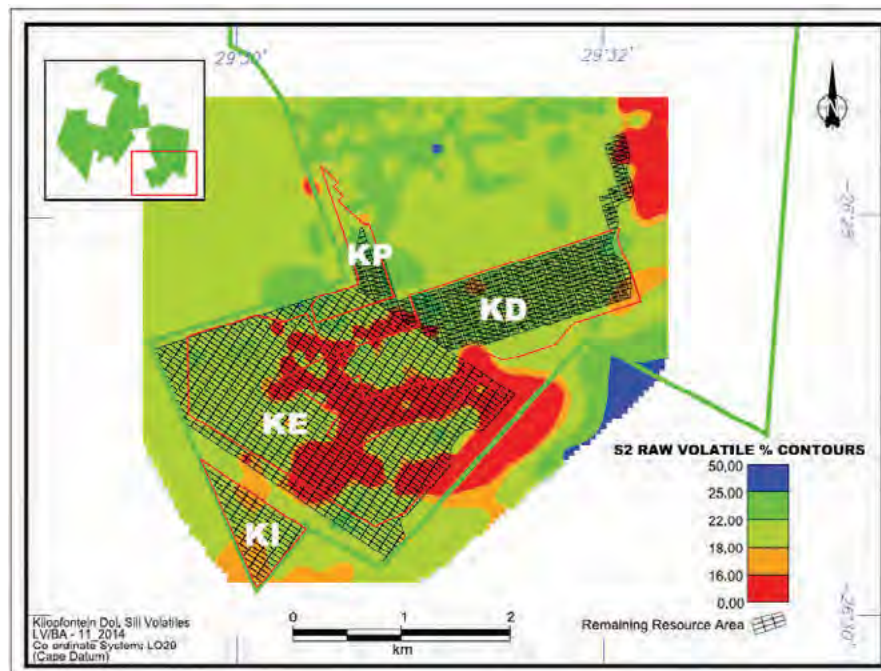

Source: SAEC

Intrusions also occur, but to a much lesser degree, in the Goedehoop and Hartbeestfontein areas.

There are no known significant faults in the Middelburg area. Faulting is rare and throws are less than 3 m.

Rolling strata, with variable strike and dip direction, occurs in the southern part of the Hartbeestfontein area, and to a lesser extent in the Goedehoop and Klipfontein areas. The formation of these rolls is ascribed to the undulating nature of the underlying basement felsite of the Bushveld Igneous Complex. Severely rolling strata with dips up to 15° adversely affect mining operations may result in increased coal losses and dilution, and adjustments to the mine plan. The rolling strata is illustrated in Figure 5.11.

Figure 5.11: Cross-section through Hartbeestfontein pit showing rolling seams

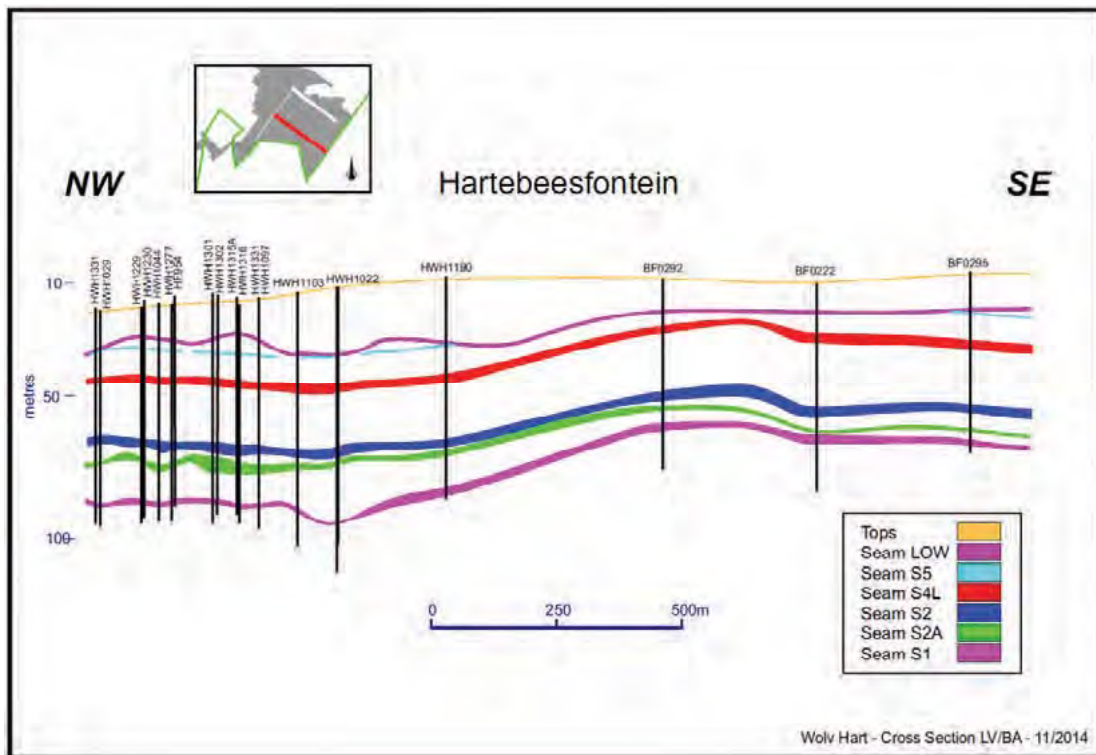

Source: SAEC

5.2.5 Coal Resources

Base data for Coal Resource estimation (Wolvekrans)

Coal Resources at Wolvekrans are reported Inclusive of Coal Reserves.

Figure 5.12 shows the borehole distribution at Wolvekrans available for geological resource modelling and estimation. The plan shows recent and historical drilling, and planned drilling for FY15.

Figure 5.12: Borehole distribution at Wolvekrans

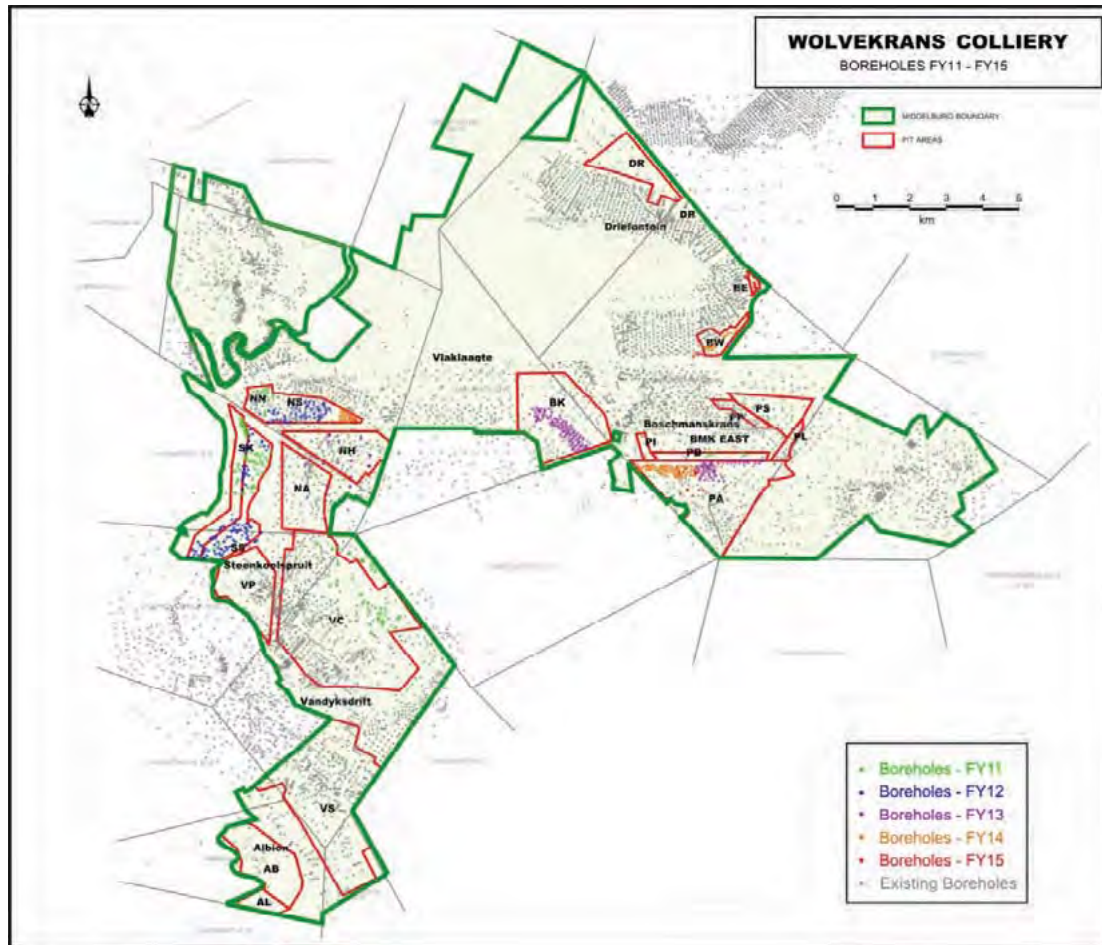

Source: SAEC

Coal Resources are estimated and reported by SAEC in accordance with the guidelines set out in the JORC Code and are detailed in Table 5.1.

All seams are included with primary product assumed to be sent for export, while Middlings products are sent to Eskom’s Duvha Power Station. The seam thickness cut-off for resource estimation is set at 1 m for opencast resources.

The Coal Resource classification is based on washed coal quality points of observation.

Table 5.1: Wolvekrans Mine Coal Resources (adb), as at 30 June 2014 on 100 per cent terms

Resource Class	Seam/Ply	Average Thickness (m)	Tonnes in-situ (Mt)	Volatiles (%)	Total Sulphur (%)	Calorific Value (kcal/kg)
BOSCHMANSKRANS and DRIEFONTEIN						
Measured	No.5	1.28	1.4	31.3	1.63	6,870
Measured	No.4L	2.42	40	23.8	1.43	5,710
Measured	No.2R	0.96	13	21.7	1.16	5,350
Measured	No.2P	4.77	33	23.0	1.05	5,890
Measured	No.2B	1.25	13	23.2	1.09	5,550
Measured	No.1	2.24	26	23.3	0.93	5,680
Indicated	-	-	-	-	-	-
Inferred	-	-	-	-	-	-
DOUGLAS AREA						
Measured	No.5	1.34	3.4	29.2	1.77	6,630
Measured	No.4UA	1.55	47	20.1	1.11	4,730
Measured	No.4L	2.03	71	24.0	1.45	5,440
Measured	No.2R	1.30	42	22.0	1.22	5,100
Measured	No.2P	3.34	74	24.8	1.15	6,010
Measured	No.2A	1.22	15	25.1	1.21	5,550
Measured	No.1	2.50	118	23.0	0.98	5,730
Indicated	No.5	-	-	-	-	-
Indicated	No.4UA	0.83	0.1	22.5	1.77	4,560
Indicated	No.4L	1.51	0.5	21.6	1.39	4,560
Indicated	No.2R	2.06	3.8	19.6	0.80	4,130
Indicated	No.2P	2.42	4.6	24.1	1.11	5,160
Indicated	No.2A	1.15	0.8	22.9	1.38	5,040
Indicated	No.1	3.29	7.8	23.5	1.01	5,640
Inferred	No.5	1.23	6.7	30.7	2.00	6,570
Inferred	No.4UA	0.95	6.7	24.2	1.98	5,220
Inferred	No.4L	1.62	20	22.5	1.04	4,710
Inferred	No.2R	1.90	16	20.9	0.89	4,510
Inferred	No.2P	3.20	17	24.6	1.06	5,440
Inferred	No.2A	1.20	5	23.5	1.22	5,110
Inferred	No.1	3.41	46	22.3	0.85	5,180
Total Measured			496	23.2	1.16	5,600
Total Indicated			18	22.7	1.02	5,100
Total Inferred			118	23.1	1.06	5,100
TOTAL WOLVEKRANS			632	23.2	1.14	5,490

Source: SAEC

Base data for Coal Resource estimation (Middelburg)

Figure 5.13 shows the borehole distribution at Middelburg available for geological resource modelling and estimation. The plan shows recent and historical drilling, and planned drilling for FY15.

Figure 5.13: Borehole distribution at Middelburg

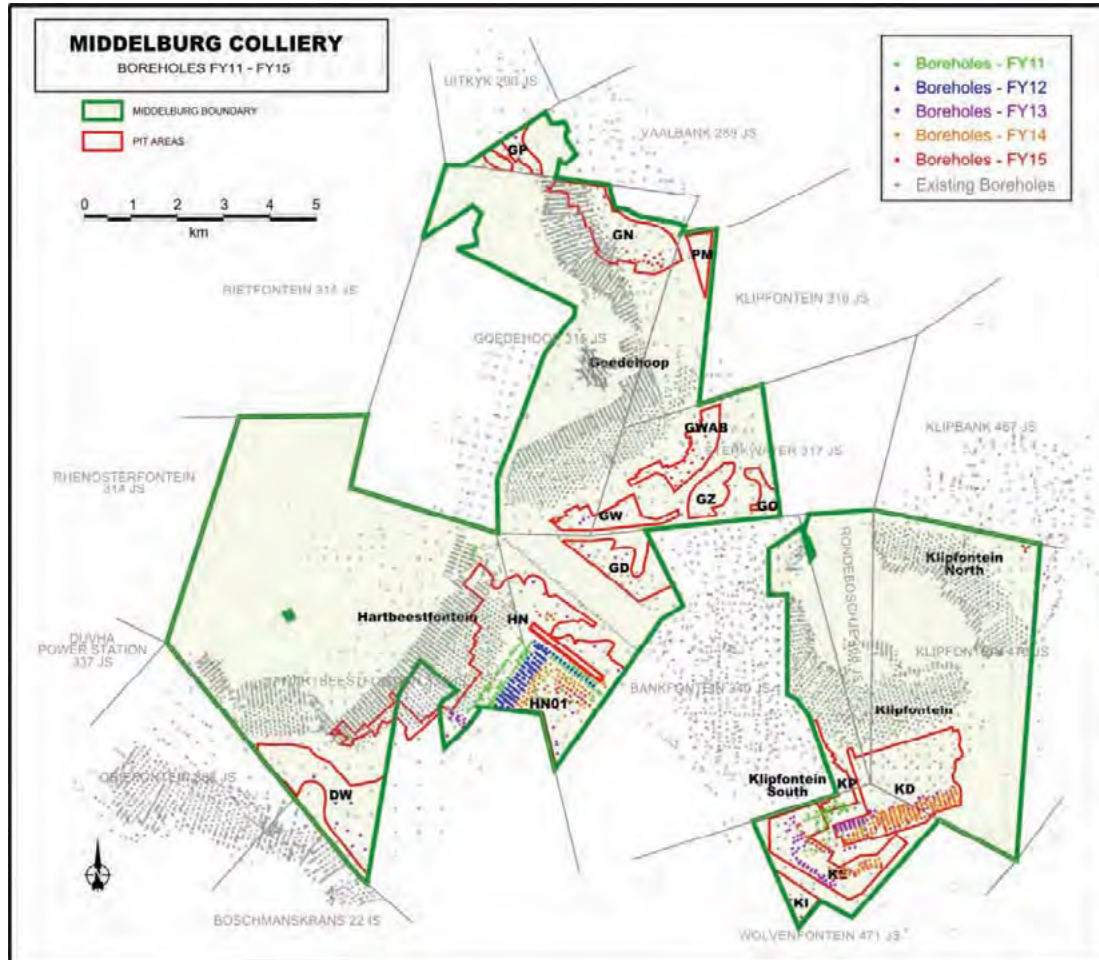

Source: SAEC

Coal Resource statement

Middelburg

Coal Resources within at Middelburg are reported Inclusive of Coal Reserves.

Coal Resources are estimated and reported by SAEC in accordance with the guidelines set out in the JORC Code and are detailed in Table 5.2. All seams are included with primary product assumed to be sent for export and Middlings product sent to Eskom’s Duvha Power Station. Seam thickness cut-off for resource estimation is set at 1 m for opencast resources.

Coal Resource classification is based on washed coal quality points of observation for all seams.

Table 5.2: Middelburg Mine Coal Resources (adb), as at 30 June 2014 on a 100 per cent basis

Resource Class	Seam/Ply	Average Thickness (m)	Tonnes in-situ (Mt)	Ash (%)	Volatiles (%)	Total Sulphur (%)	Calorific Value (kcal/kg)
GOEDEHOOP							
Measured	No.4L	2.2	3.4	24.6	20.2	0.99	5,490
Measured	No.2	2.1	13	32.1	20.4	0.86	4,820
Measured	No.2A	2.3	24	23.8	21.9	1.08	5,660
Measured	No.1	2.1	23	25.2	23.4	1.08	5,660
Indicated	-	-	-	-	-	-	-
Inferred	No.2	2.1	0.6	41.0	18.8	0.95	4,010
Inferred	No.2A	2.2	4	22.6	21.6	0.83	5,730
Inferred	No.1	1.8	2	24.4	23.9	0.95	5,710
HARTBEEFONTEIN							
Measured	No.4UA	1.1	1.2	23.9	21.5	1.72	5,660
Measured	No.4U	1.6	3.1	34.0	19.6	1.02	4,680
Measured	No.4L	2.2	18	23.8	21.8	1.13	5,680
Measured	No.2	3.3	41	33.9	19.5	0.89	4,730
Measured	No.2A	1.9	11	29.3	21.6	1.05	5,230
Measured	No.1	1.7	14	24.6	24.4	1.08	5,730
Indicated	-	-	-	-	-	-	-
Inferred	-	-	-	-	-	-	-
KLIPFONTEIN							
Measured	No.4UA	1.3	2.1	21.5	21.4	1.61	5,850
Measured	No.4L	3.0	20	28.2	21.7	1.23	5,250
Measured	No.2U	1.6	0.5	29.7	20.5	1.05	5,130
Measured	No.2	4.7	36	25.2	20.9	0.93	5,520
Indicated	-	-	-	-	-	-	-
Inferred	-	-	-	-	-	-	-
Total Measured			211	28.0	21.7	1.04	5,410
Total Indicated			-	-	-	-	-
Total Inferred			7.3	24.7	22.1	0.88	5,600
TOTAL MIDDELBURG			218	27.9	21.7	1.04	5,420

Source: SAEC

5.2.6 Coal Reserves

Introduction

The Wolvekrans and Middelburg Mines are currently owner operated, with contractors used where relevant to assist operations.

For the estimation of the tonnages in the WMC Coal Reserve Statement, the geological and economic boundaries of the open cut operation were determined based on the mining

rights boundary, economic cut-off thickness and minimum separation distances from surface features such as water courses, water pipelines, power lines and local villages.

SAEC has developed a financial model based on the estimated production, mining and processing costs and capital expenditure to demonstrate the economic viability of extracting these Coal Reserves.

During Xstract's review, the schedule for WMC was checked for consistency, tallying with the Coal Resources from which these Coal Reserves have been converted, and the practical achievability of the mining rates. Future production targets are significantly higher than current performance, however this is further discussed in Section 5.2.7.

The results presented in the LOA schedule are different from those declared in the Coal Reserves Statement. The differences are primarily a consequence of the current LOA schedule including certain Inferred Resources associated with mining at the Vandykesdrift South ("VDDS") and Albion pits, a total of around 69 Mt. There are also some Inferred blocks that will be mined as a consequence of exploiting the Coal Reserve blocks, but this is minimal.

Wolvekrans

Table 5.3 presents the Wolvekrans Coal Reserves estimate as prepared by SAEC under the JORC Code guidelines. The Coal Reserves at Wolvekrans have been well defined, with 96 per cent of the reserves in the Proved category and only four per cent classified as Probable. There are however, Inferred Resources, which may be converted to reserve status with further definition drilling and associated studies.

Table 5.3: Wolvekrans Coal Reserves (adb)

Project	Mining Method	Proved	Probable	Total	Proved Marketable Reserve				Probable Marketable Reserve			
		Mt ROM (adb)	Mt ROM (adb)	Mt ROM (adb)	Mt (adb)	Ash (%)	CV (kcal/ kg)	TS (%)	Mt (adb)	Ash (%)	CV (kcal/ kg)	TS (%)
Wolvekrans (June 2014)	Opencast	389	17	406	273	21.8	6,010	0.47	12	22.5	5,950	0.45
Wolvekrans (Dec 2014)	Opencast	382	17	399	268	21.8	6,010	0.47	12	22.5	5,950	0.45

Source: SAEC

The June 2014 Coal Reserves for Wolvekrans are some 21 Mt lower than reported in June 2013. The June 2013 Coal Reserves at Wolvekrans were reported as 427 Mt of ROM, which were depleted due to production by 14.3 Mt ROM and further depleted by 7 Mt ROM mainly to changes in geological information and changes in the loss and dilution parameters. The final Coal Reserves in June 2014 were reported as 406 Mt ROM.

The planned mining areas relative to the Mining Right area is shown in Figure 5.2.

The Inferred Resource has not been included in the Coal Reserve estimate, however it has been assigned a value in the economic margin ranking of pits to determine whether the coal is profitable and therefore capable of supporting a Coal Reserve. The Inferred Resource occur in three pits only, as summarised in Table 5.4. The issue is that in all of these pits, over 45 per cent of the coal used to determine the pit economics is Inferred. There is a risk that if the Inferred coal is excluded, then the presently defined Coal Reserves within the pit may not be economic on a standalone basis. This in turn suggests that the currently defined coal is unable to be classified as a Coal Reserve. Historically, the conversion rate at WMC from Inferred Resources to Coal Reserve has been typically high.

Table 5.4: Wolvekrans Inferred Resource by pit (adb)

Pit	Proved & Probable ROM (Mt)	Inferred ROM (Mt)	Percentage Inferred %
VDD South (VS)	42.6	46.4	52%
Albion (AB)	17.4	15.3	47%
Albion (AL)	0.0	7.2	100%
Total	60	69	

Source: SAEC

Middelburg

Table 5.5 shows the Middelburg Coal Reserves estimate as prepared under the JORC Code guidelines. The Coal Reserves at Middelburg have been well defined, with 100 per cent of the Reserves in the Proved category, with the LOA including only a small amount of Inferred Resources.

Table 5.5: Middelburg Coal Reserves (adb)

Project	Mining Method	Proved	Probable	Total	Proved Marketable Reserve				Probable Marketable Reserve			
		Mt ROM (adb)	Mt ROM (adb)	Mt ROM (adb)	Mt (adb)	Ash (%)	CV (kcal/ kg)	TS (%)	Mt (adb)	Ash (%)	CV (kcal/ kg)	TS (%)
Middelburg (June 2014)	Opencast	97	0	97	80	23.2	5,890	0.47	-	-	-	-
Middelburg (Dec 2014)	Opencast	94	0	94	78	23.2	5,890	0.47	-	-	-	-

Source: SAEC

The planned mining areas, in comparison to the mining rights area, are as shown in Figure 5.3.

The June 2013 Coal Reserves at Middelburg were reported as 125 Mt of ROM which were depleted due to production by 5.5 Mt ROM and further depleted by 22 Mt ROM mainly to layout changes to stay 100 m from powerlines and waterlines, along with some changes in the geological grids. The Coal Reserve as at 30 June 2014 was reported as 97 Mt ROM.

Reconciliation and modifying factors

Wolvekrans Mine

Losses and dilution

Numerous seams are mined at Wolvekrans Mine, however geological losses are the same for each seam in a pit and geologic losses are instead differentiated by mining area. Geological losses for each area are based on historical data as shown in Table 5.6.

Table 5.6: Geologic Losses

Area	Losses
SK	4%
SS	4%
NS	4%
BMK East	3%
All Other Areas	2%

Source: SAEC

Losses and dilution assumptions for all seams are as shown in Table 5.7.

Table 5.7: Seam Losses and Dilution

Coal Losses	Losses and Dilution						
	No.5	No.4U	No.4L	No.2R	No.2P	No.2B	No.1
Floor (m)	0.13	0.13	0.13	0.13	0.13	0.13	0.13
Roof (m)	0.13	0.13	0.13	0.13	0.13	0.13	0.13
Edge (m)	Nil	Nil	Nil	1.0	1.0	1.0	1.0
Waste Dilution							
Total Seam	4%	4%	4%	22%	22%	22%	4%

Source: SAEC

For No.5 Seam, the assumption of nil edge loss is likely to be optimistic, however, this seam sits above the dragline horizon and so there is likely to be reduced edge losses. Waste dilution would typically be calculated by first principles from edge, roof and floor dilution assumptions and so would vary with coal thickness. However, Wolvekrans use an assumed constant dilution of 4 per cent across all seams.

No.4 Seam is split into an upper ply No.4U and a lower ply No.4L. For No.4 Seam, nil edge loss is likely to be an optimistic assumption, however, mining economics of the operation will have low sensitivity to edge losses in one of the seams.

No.2 Seam has the previous underground workings through it and so to cater for this, for reserves estimation and mine planning, the seam has been reserved in three horizons as follows:

- No.2R – No.2 Seam Roof, seam left in-situ in roof during Bord & Pillar mining
- No.2P – No.2 Seam Pillars, coal horizon left as pillars after Bord & Pillar mining
- No.2B – No.2 Seam Floor, seam left in-situ in floor during Bord & Pillar mining.

For each of the No.2 Seam horizons, the higher edge losses result from the seam being within the dragline horizon and the higher dilutions stem from historical measurements of coal dilution through the underground worked areas.

No.1 Seam is the lowest seam in the stratigraphic sequence.

Seam Aggregation

Coal Reserves are affected by the rules used in the seam aggregation process. Seam aggregation is relevant when seams, or partings between seams, change in thickness and therefore it becomes more logical to mine, or waste, the seam as part of a different seam grouping. Grouped coal plies and partings together into mining units are called working sections. The three primary rules used in the seam aggregation decision-making process were as follows:

- Thickness based rules – maximum parting thickness before the coal will be mined as two separate plies and the partings in between treated as waste. The other thickness rule is the minimum coal thickness at which the coal seam will be mined by itself.
- Quality based rules – following the creation of working sections, the working sections are then assessed against maximum quality cut offs to ensure the coal is mineable.
- Override rules – these provide the flexibility to waste or mine seams if relevant, or to change the floor of the pit where required.

The thickness rule cut offs are as shown in Table 5.8. The numbers specified for parting are the maximum thickness of parting allowed where the coal plies either side, along with the parting, will be combined into one working section. The numbers specified for coal are the minimum thickness at which that coal seam will be mined as a stand-alone coal unit. No.2R and No.2P are both part of No.2 Seam and are used to designate the roof coal and the pillar coal, thus the minimum coal thickness is effectively zero as they are part of a larger seam.

Table 5.8: Thickness Rules

Wolvekrans Thickness Rules							
	No.5	No.4U	No.4L	No.2R	No.2P	No.2B	No.1
Parting (m)	0.3	0.3	0.3	0.3	0.3	0.3	0.3
Coal (m)	1.0	1.0	1.0	0.01	0.01	1.0	1.0

Source: SAEC

The quality rule cut offs are as shown in Table 4.11.

Finally, override rules are applied where relevant and these are primarily about maintaining sufficient accuracy in modelling the actual mining process. So for example if one block in the midst of a strip has the lowest seam wasted due to one of the previous two rules, this will need to be corrected to stop a significant change in level of the pit floor for that one block.

Middelburg Mine

Losses and dilution

Standard geological losses of 2 per cent have been applied across the Middelburg pits, except in areas of geological complexity. So for example in areas of Klipfontein where dolerite dykes and sills are numerous and in other areas where the seams roll over basement felsite and so have seam gradients over 10 per cent. In these more complex areas, geological losses of 4 per cent have been applied instead.

Losses and dilution assumptions for all seams are displayed in Table 5.9.

Table 5.9: Seam Losses and Dilution

Losses and Dilution							
Coal Losses	No.4UA	No.4U	No.4L	No.2A	No.2	No.2L	No.1
Floor (m)	0.225 m	0.225 m	0.225 m	0.225 m	0.225 m	0.225 m	Nil
Roof (m)	0.225 m	0.225 m	0.225 m	0.225 m	0.225 m	0.225 m	0.225 m
Edge (m)	Nil	Nil	Nil	1.0 m	1.0 m	1.0 m	1.0 m
Waste Dilution							
Total Seam	3%	3%	3%	3%	3%	3%	3%

Source: SAEC

No.4 Seam is split into three plies, the No.4UA, No.4U and a lower ply, No.4L. For No.4 Seam, nil edge loss is an optimistic assumption, however, mining economics of the operation will have low sensitivity to edge losses in one of the seams. Waste dilution would typically be calculated by first principles from edge, roof and floor dilution assumptions and so would vary with coal thickness, however, Middelburg use an assumed constant dilution of 3 per cent across all seams.

No.2 Seam is split into three plies, the No.2A, No.2 and No.2L. Losses and dilution assumptions for all seams are displayed in Table 5.9.

No.1 Seam is the lowest seam in the stratigraphic sequence. Zero floor losses have been assumed as this seam constitutes the pit floor, however, this is an optimistic assumption and there will likely be some losses.

Seam Aggregation

The same seam aggregation process has been applied to the Middelburg mining operations as that used at Wolvekrans. The thickness rule cut offs are as shown in Table 5.10.

Table 5.10: Thickness Rules

Middelburg Thickness Rules							
	No.4UA	No.4U	No.4L	No.2A	No.2	No.2L	No.1
Parting (m)	0.5	0.5	0.5	0.5	0.5	0.5	0.5
Coal (m)	1.0	1.0	1.0	1.0	1.0	1.0	1.0

Source: SAEC

The quality rule cut offs are as shown in Table 4.11.

Finally, override rules are applied where relevant and these are primarily about maintaining sufficient accuracy in modelling the actual mining process. So for example if one block in the midst of a strip has the lowest seam wasted due to one of the previous

two rules, this will need to be corrected to stop a significant change in level of the pit floor for that one block.

5.2.7 Mining

Geotechnical/hydrology considerations

Geotechnical

A comprehensive Code of Practice covering rock falls and wall instability has been established for Wolvekrans and Middelburg. This document outlines a history of previous incidents, as well as future actions to minimise the likelihood of future incidents. Between 2003 and 2012, there were 28 geotechnical related incidents at Wolvekrans. Between 2002 and 2012, there were five geotechnical related issues at Middelburg. A breakdown of these incidents is presented in Table 5.11.

The most common issue is one of loose rock falls and these are typically handled by implementation of modified operational practices. Highwall instability is a more critical issue and higher risk, but there have only been eight incidents in the last 10 years, so geotechnical issues do not appear to be critical at either Wolvekrans or Middelburg.

Table 5.11: Wolvekrans and Middelburg Mines - Wall Stability Incidents

<u>Incident Description</u>	Wolvekrans		Middelburg	
	<u>Cases</u>	<u>Percent</u>	<u>Cases</u>	<u>Percent</u>
Loose rock fall from highwall during clean up	6	22%	1	17%
Loose rock fall from highwall – other	9	33%	2	33%
Highwall collapse	6	19%	2	33%
Loose rock fall from spoils	1	4%	1	17%
Sinkhole formation	1	7%		
Dump face collapse	4	15%		

Source: SAEC

Hydrology

Currently there is an issue with water disposal throughout the WMC.

In the short-term, SAEC has relied on enhanced evaporation to increase production and provide space in the workings to continue mining. This is effective and low risk, but expensive, as evaporators are a large user of electricity and ultimately lead to higher concentrations of soluble salts in the water. As a result, this does not present an effective long-term water management solution.

The long-term solution is to install water treatment plants, which SAEC has planned for over the mid to longer term.

A water balance study has been carried out at Middelburg and the mine produces a surplus of dirty water between 30 MI/d to 50 MI/d. This is expected to increase over time as undisturbed areas are mined and then subsequently rehabilitated. Surplus water was previously stored in old surface and underground workings and surface dams, however, this storage capacity has been depleted over time and will eventually be completely depleted. SAEC has long term plans to install water treatment plants. This is further discussed in Section 5.2.14.

Mining methods and access

Mining is carried out at Wolvekrans and Middelburg using open cut mining methods typical of the South African open cut coal industry, comprising a mix of dragline and truck/shovel. The mining areas are divided into pits of varying shapes with the pit configuration based on economic parameters and other drivers, such as surface infrastructure and environmental constraints.

Pits with longer strike lengths incorporate draglines in uncovering the coal, while shorter and odd shaped pits use truck and shovel only. This is a very common coal mining methodology and therefore is perceived to be very low risk.

Wolvekrans

Wolvekrans is the result of the merger of five different collieries within mining in its current configuration having commenced in 2010. As a result, there is a complexity at Wolvekrans that makes it unique to SAEC, but not uncommon to the Witbank area, and adds a high degree of operational risk.

The No.1, No.2 and No.4 Seams throughout much of the mining area have been previously mined as part of underground operations by a bord and pillar method at the old Douglas underground mine. Remnants of these seams are now being recovered as part of the proposed open cut operations. Figure 5.2 and Figure 5.3 highlight the significant overlap between previously completed underground workings and the planned open cut mining areas.

The presence of these underground workings throughout the open cut mining areas lead to a substantially increased risk of spontaneous combustion. In order to reduce this risk SAEC has introduced a specialised mining method at Wolvekrans. Waste for the next strip is blasted as close as possible behind the advancing mined coal face. This process reduces the oxygen ingress into the underground working areas, consequently reducing the likelihood of spontaneous combustion. This process of cladding is shown in Figure 5.14, with the cladding shown in yellow and progresses along the strip as close as possible behind the coal mining operation.

Figure 5.14: Wolvekrans Mine Cladding Process

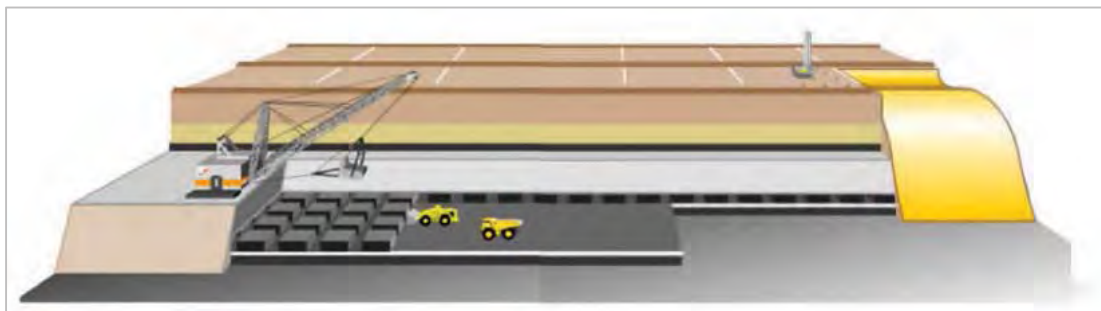

Source: SAEC

The amount of coal affected by underground workings at Wolvekrans is increasing, as shown in Figure 5.15 and so effective coal mining methodologies are critical to the future of Wolvekrans. Blasting is not required as the coal is sufficiently soft. This reduces the risk associated with placing equipment or personnel on the top of coal seam and any associated accidents due to the presence of voids in the seam.

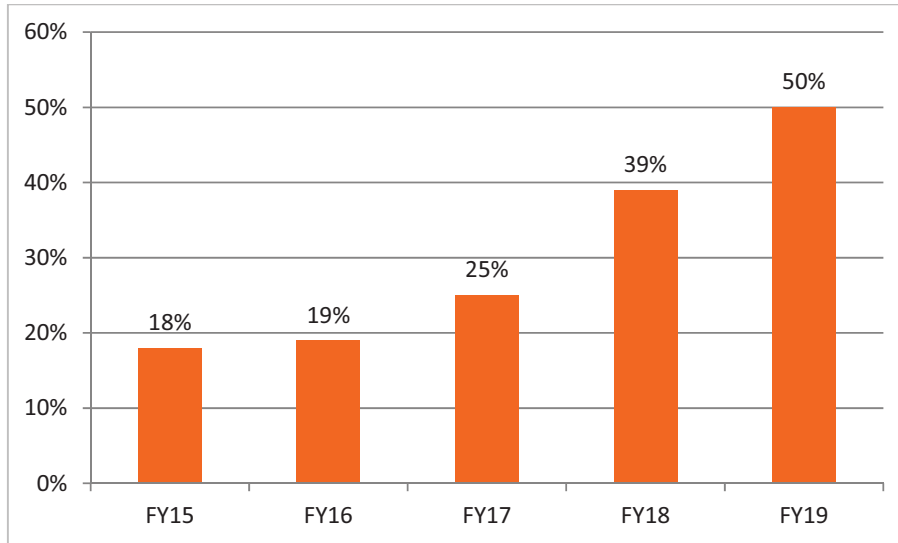
Figure 5.15: Wolvekrans Mine Pillar Coal (No.2P) Percentage

Source: SAEC

Coal mining is primarily carried out by Cat 994 loader and Cat 789 rear dump haul trucks. This equipment is considered suitably sized in order to extract coal seams of at least 1 m in thickness. Unlike excavators, loaders also work the coal seam from the floor, and are suited to a process where equipment is not placed on top of the coal.

Middelburg Mine

Middelburg pits are typically very shallow and so the dragline can excavate the necessary depth to uncover the coal seam. As such, there is generally no need for truck and shovel operations to pre-strip waste above the dragline horizon. Where any pre-strip may be required, it is carried out by contract operations.

The Middelburg operating pits are shown in Figure 5.3. There are six pits in total. The large number of smaller pit areas results in limited working areas for the two draglines. This leads to very limited flexibility in the dragline working methods and sequence. It also dictates that draglines are parked up before the end of the mine life and the remaining pits are operated by contract truck and shovel operations.

Coal mining of the +1 m thick seams is primarily carried out by Cat 993 or 994 loader and Cat 785 rear dump haul truck, which is a well proven method of coal operations.

Historical and forecast operating statistics

Wolvekrans Mine

In most opencut coal mining operations, the ratio of waste excavation to coal mining is critical to the overall cost efficiency of the mine. In SAEC's opencut operations, it is therefore important to consider historical efficiency of the major items of equipment operating in the waste removal.

Wolvekrans is predominantly a dragline operation. The historical dragline annual operating hours for FY12 to FY14 are approximately 5,800 annual operating hours compared against the forecasted 6,300 annual operating hours over the next five years. This shows a substantial increase in annual hours for each of the three draglines used at Wolvekrans,

relative to historical performance. Analysis shows that these proposed improvements actually stem from reductions in equipment downtime, which represent an increase in equipment availability.

Whilst the forecast annual operating hours of 6,330 going forward represent a significant increase over current performance, Xstract considers they are a reasonable target. There are currently numerous BHP Billiton mines successfully operating draglines at over 6,300 operating hours annually.

Importantly, overall average productivity for the three draglines is 2,051 bcm/hr for the five year plan (FY15 to FY19), which compares favourably to historical performance (FY12 to FY14) of 2,048 bcm/hr.

Truck and shovel operations at Wolvekrans are well below best practice at around 4,500 operating hours annually. The forecast 5,900 operating hours represent a substantial, but reasonable, improvement, which would bring Wolvekrans into line with numerous other BHP Billiton operations. Whether this improvement is able to be achieved in FY15 is a tall task, but should be achievable within a few years.

Productivity associated with shovel production is forecast to improve significantly going forward relative to past performance. Current shovel productivity is around 1,100 bcm/hr, whilst SAEC is forecasting rates around 1,600 bcm/hr for its 700 t excavators. Xstract notes that this improvement occurs over the next two to three years and requires close management supervision to ensure these improvements are achieved

Middelburg Mine

As with Wolvekrans there is a SAEC management focus on productivity gains with the draglines and truck and shovel operations associated with the waste removal. The average dragline annual operating hours for the last three years (FY12 to FY14) was 5,744 hrs while the forecast over the next five years (FY15 to FY19) averages 5,323 hrs. This decrease in hours reflects planned major shutdowns for dragline maintenance.

Of the two draglines at Middelburg, one shows a continual increase in productivity to 2,484 bcm/hr in FY18. This is a reasonable production rate for a BE1570-sized dragline. The other dragline shows lower average productivity due to reconfiguration of the pits.

Any truck and shovel waste excavation at Middelburg is carried out by contractors, rather than SAEC-owned equipment and so truck/shovel operating statistics are not relevant for Middelburg.

Production schedule

Wolvekrans Mine

Figure 5.16 shows the historical annual ROM coal production for the last three years, in addition to the LOA planned production. There is a gradual increase in annual coal production at Wolvekrans Mine until the peak at 28.8 Mt in FY30. Coal production then declines until the end of mine life during FY39. The growth in coal production from 14.3 Mt in FY12, to 28.8 Mt in FY30 represents a doubling in production. However, this is over a period of 18 years and so represents an achievable rate of increase.

Figure 5.16: Wolvekrans LOA Production Breakdown

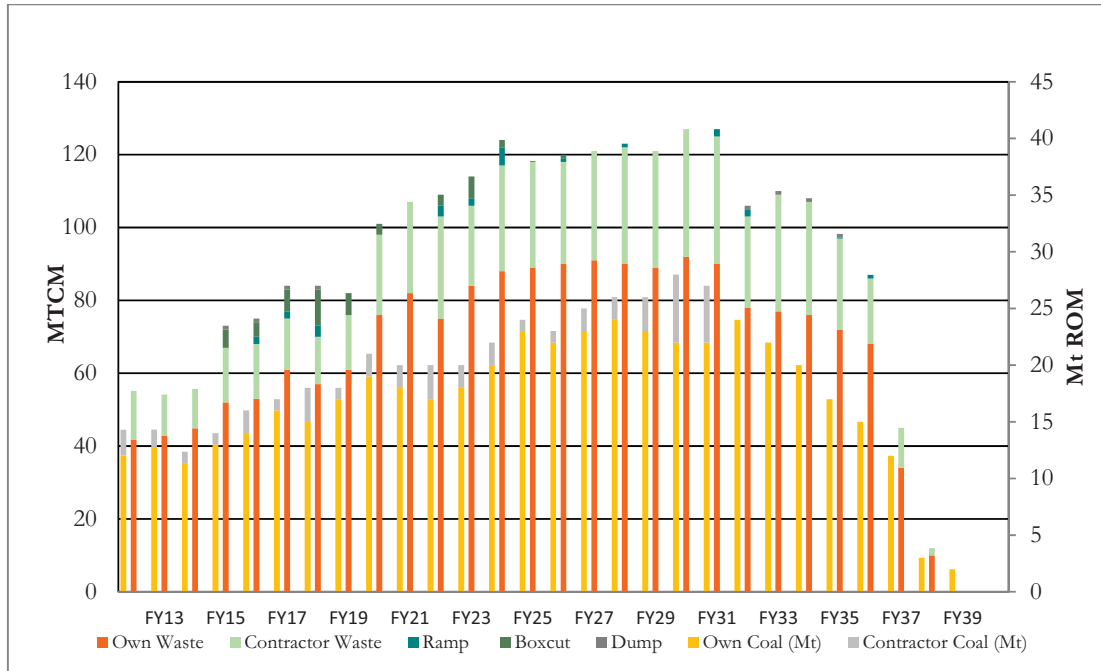

Source: SAEC

As with annual coal production, the total waste excavation gradually increases every year and peaks in FY31. The total excavation in FY31 of 130 TCM is a 135 per cent increase over the FY12 annual volume excavation of 55 TCM.

Middelburg Mine

Conversely to Wolvekrans and the planned doubling of production there, Middelburg Mine peaks within the five year plan timeframe, before gradually decreasing. Figure 5.17 shows the historical annual ROM coal production for the last three years in addition to the LOA planned production breakdown.

There is a slight increase in annual coal production at Middelburg until the peak at 6.5 Mt in FY18. Following this peak, the coal production declines to a range around 4 Mtpa for a period of eight years, before then gradually declining until the end of mine life in FY38. Given historical coal production rates have been in the vicinity of 6 Mtpa, future coal production should be easily achievable.

Annual waste production is maintained at approximately 35 Mbcm until FY27. A single dragline is removed from production due to strike length constraints. The mine switches to contractor operator from owner operations in FY31 with the last SAEC owned dragline removed from production, and the entire mine moves to a truck and shovel operation until production ceases in FY38.

Figure 5.17: Middelburg Production Breakdown

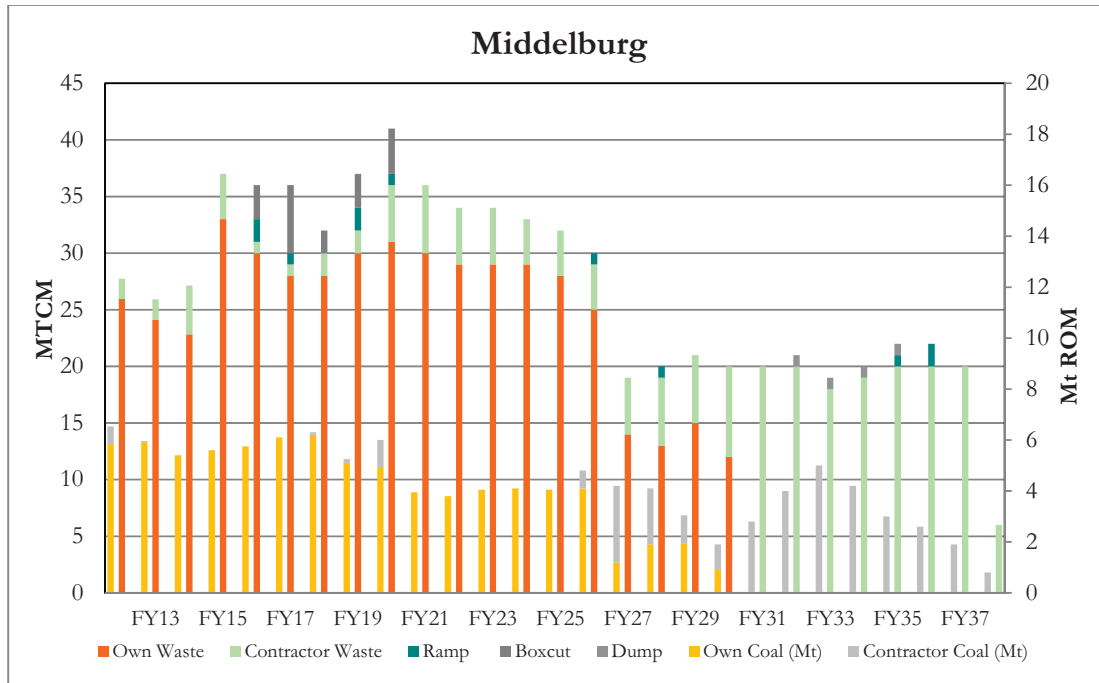

Source: SAEC

Based on the stated Marketable Reserves, the scheduled split of marketable products is provided in Table 5.12.

Table 5.12: WMC Marketable Reserve tonnes scheduled according to product split, at 30 June 2014

WMC	FY15 (Mt)	FY16 (Mt)	FY17 (Mt)	FY18 (Mt)	FY19 (Mt)	FY20- FY24 (Mt)	FY25- FY29 (Mt)	FY30- FY34 (Mt)	FY35- FY39 (Mt)
ROM	17,980	21,154	23,381	24,216	23,842	125,360	141,530	100,610	24,927
Benchmark	8,177	8,015	9,028	8,877	9,600	47,227	49,500	26,921	-
4,800 kcal/kg	335	670	1,150	1,200	1,200	7,873	6,000	6,000	9,227
Domestic	8,500	8,500	8,500	8,500	8,500	42,500	42,500	36,500	-
Total Dump Allocated	5,400	6,600	7,200	7,200	6,600	28,800	8,400	-	-

Source: SAEC

Notes:

1. Dump tonnages are in addition to the reported Coal Reserves
2. Dump yield is assumed to be 30%
3. All dump product reports to 4,800 kcal/kg product specification

5.2.8 Coal processing

SAEC Coal Processing comprises five coal beneficiation plants – North Export Plant, North Middlings Plant, South Eskom Plant VDD mobile plant and South Export Plant (Figure 5.1). Total coal beneficiation washes approximately 21 Mtpa of ROM coal and 6 Mtpa of dump material across the mine complex.

The North Plant consists of a coal washing and middlings plant, with slurry, discard and reject as residue. The coal beneficiation plant washes approximately 8.2 Mtpa ROM to a product ash content of 16.3 per cent (adb). Coal is supplied to the plant from Middelburg Mine's Goedehoop and Hartebeestfontein and Klipfontein operations (via an overland conveyor). The coal is crushed, washed and transported to the rapid loadout rail terminal by means of a 7 km overland conveyor. The coal is then railed from the siding via Broodsnyersplaas to Richards Bay.

At the South Eskom Plant and South Export Plants, coal is received from the Wolvekrans mining operations and is processed for supply to the Duvha Power Station and the export market. Coal is conveyed from the mining areas to the Plants. There are two overland conveyor belts that convey the coal to the Duvha Power Station (steel core belts).

The South Eskom Plant consists of a three stage crushing plant, comprising three processing lines. Each line consists of a Stamler crusher at the bottom of the bin, a transfer belt to the rotary breaker, a rolling ring crusher and twin conveyor belts discharging into staithes at Duvha Power Station.

Small amounts of slurry are produced at this plant. Depending on the ash and yield of the incoming ROM, the coal is either diverted to the rolling ring crushers or diverted to a destoning facility consisting of a Larcodem processing facility. Reject from the destoning plant is placed in an open final mined out void. Other infrastructure on site includes surface workshops, coal stockpiles, administrative offices, pollution control dams, rail siding and silos.

The South Export Plant was constructed to improve the quantity of export coal as well as to produce middlings for Duvha Power Station (re-washing of export discard in a second stage wash produces a "middlings" that is suitable for use in the power station). The new plant includes a coal washing facility, which generates fine tailings. The tailings (slurry) are deposited on a designated disposal facility. Other infrastructure includes pollution control dams, return water dam, coal stockpile areas, etc.

CHPP facilities at BCP form a complex logistics chain allocating coal for processing and transportation according to coal quality and/or logistical constraints.

Combined the north (Middelburg) and south (Wolvekrans) processing facilities contain approximately 160 km of conveyors and an internal rail system (capacity 4 Mtpa North to South and vice versa) to move approximately 28 Mtpa of ROM material around the BCP complex (according to the FY16 optimised base plan – Figure 5.18).

Figure 5.18: BCP Material Movements

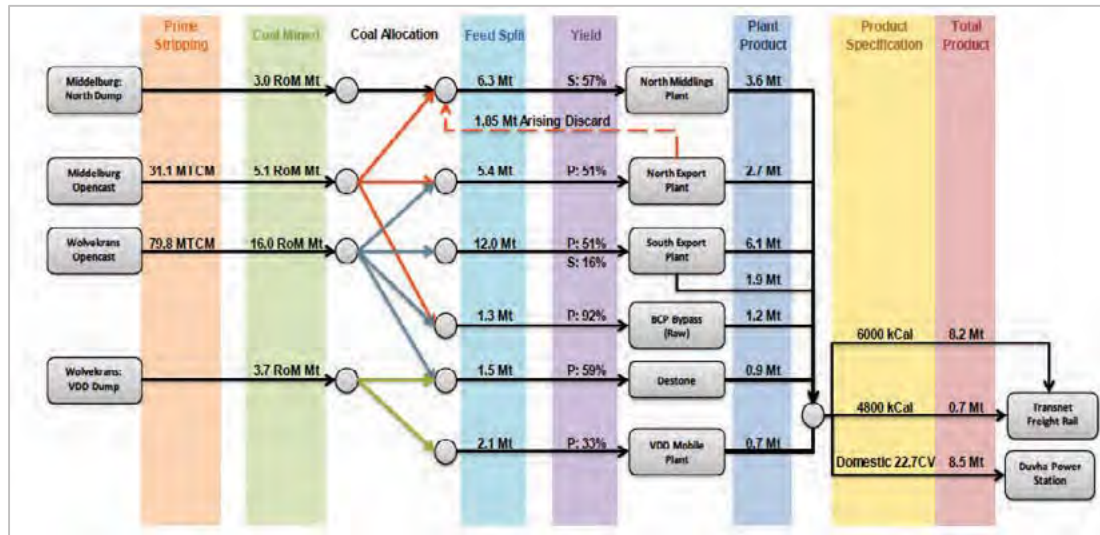

Source: BCP

The major BCP infrastructure consists of:

- North
 - Three ROM tips
 - 200 kt of direct reclaim raw coal stockpiles
 - Export processing plant
 - Middlings processing plant
 - 200 kt export product coal stockpiles (80 kt live and the rest dead)
 - Tailings dam
- South
 - Seven ROM tips
 - 108 kt of direct reclaim raw coal stockpile
 - Export processing plant (integral with middlings processing)
 - 150 kt export product stockpile (live)
 - South Eskom plant (including de-stoning processing facility)
 - 180 kt Eskom product stockpile capacity
 - Five tailings drying cells
- Common
 - Internal rail system
 - Export rail loadout system
- VDD plant
 - 1.2 Mtpa processing plant currently being expanded to 2.4 Mtpa
 - Refurbished VDD rail loadout system

Figure 5.19 provides an overview of the BCP logistics system.

Figure 5.19: BCP Logistics System Flow Diagram

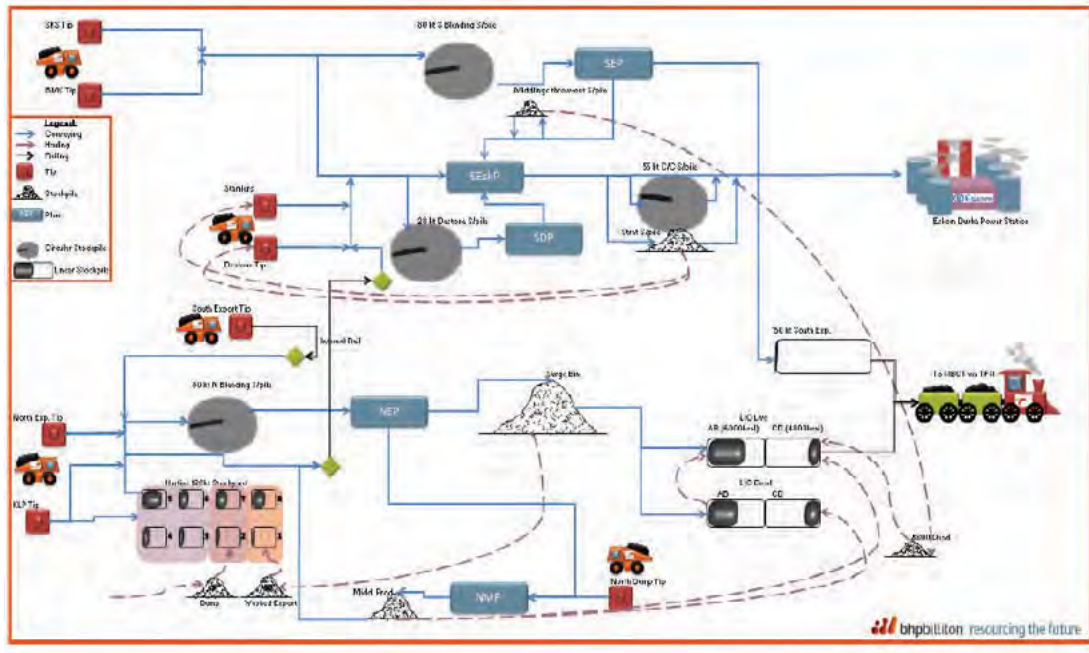

Source: BCP

Coal quality

SAEC currently produces three saleable products at BCP for the domestic and export markets, through a combination of raw coal bypass, coal washing (primary and secondary circuits) and final blending:

1. Domestic coal supply contract with Eskom comprising 8.5 Mtpa at 16.3 per cent ash (adb)
2. 4,800 kcal/kg (NAR) Export
3. Benchmark Product

Export tonnages are dictated by supply contracts, rail and port allocations with TFR and RBCT respectively.

Coal allocation

The following constitute the set of rules applied by SAEC to allocate ROM coal to BCP facilities:

- Export yield cut-off is +/-30 per cent yield. All coal calculated at 30 per cent yield or above is transported to a Primary Export circuit and washed to reach export targets.
- All coal calculated at below 30 per cent yield and still within the ROM quality cut-off parameters will be categorised as Eskom. Should the coal meet Eskom specification in its raw state it will be bypassed as Eskom product or else processed in the Destone plant.
- ROM coal from Hartebeesfontein No.2 section is normally directed to BCP's North Middlings plant along with materials from the Middelburg Discard Dump and Arising Discard (middlings) from the North Export plant.

- Coals from Klipfontein and the rest of the Hartebeesfontein sections are transported to the North Export plant or the loadout as an Eskom or 4,800 kcal/kg export quality product.
- Coals from the Boschmanskrans West, Deep Far South and Driefontein sections can be railed to the North Export plant, due to long distance to the tips supplying the main conveyor from Steenkoolspruit. The export rail tip is the closest to these pits.
- VDD Dump coal is directed to the Destone plant and the new VDD mobile plant.
- All pillar seams from previous underground coal workings must be washed.

Processing method

Coal crushing, stockpiling/blending and processing technology utilised across BCP's operations is standard technology that has been used in operating coal plants worldwide for over 50 years.

Before entering each processing facility ROM/Raw coal enters a 3-stage crushing system to reduce particle topsize to -50 mm.

The general allocation assumptions are listed in the section above.

Each export plant (North Export and South Export) has a blending stockpile from which coal is reclaimed as plant feed.

South Export plant

The South Export plant is designed to process 14 Mtpa of coal in two modules (1,000 tph each).

Each module has two low-density DMC circuits producing the primary export product:

- The first processing coal in the -50 mm to +8 mm size fraction.
- The second processing coal in the -8 mm to +0.6 mm size fraction.

Each module has a single high-density DMC circuit taking discard from the low-density circuits (-50 mm to +0.6 mm) and producing a middlings product.

Deslimed fine coal (-0.6 mm to +0.1 mm) is processed in conventional spirals circuits. The clean coal is dried and can report to either the primary export or middlings export product.

Coarse and fine rejects are combined and transported via conveyor to the discard bin ready for disposal.

Coal slimes are treated differently at each of the export plants. At the South Export plant, the slimes (-0.1 mm) are thickened and pumped to one of five tailings cells. After drying in the cells the slimes are then recovered and then disposed.

North Export plant

Unlike the South Export and Phola plants, the North Export plant produces a single primary export product only. The plant was originally built with three processing modules and was designed to process 12 Mtpa of raw coal.

The recent decommissioning of one of the modules (to allow raw coal to bypass the plant) has reduced its capacity to 8 Mtpa.

At the North Export plant, each module contains the following processing circuits:

- Low-density DMC circuit processing the coarse (-50 mm to +0.6 mm) size fraction.
- Spirals circuit processing the fine (-0.6 mm to +0.1 mm) size fraction.
- Tailings thickeners dewatering the slimes (-0.1 mm) for disposal in the tailings dam.

North Middlings plant

The North Middlings plant is a separate facility to the export plant as it enables a middlings product to be produced from the:

- North Export plant discard.
- Middelburg discard dump, which is resultant of a single stage wash from the old Middelburg operations.
- Low quality destone coal from Middelburg.

The North Middlings plant is designed to process 7.2 Mtpa of feed coal. The plant contains three processing modules comprising:

- High-density DMC processing the coarse (-50 mm to +1 mm) size fraction.
- Spirals circuit processing the fine (-1 mm to +0.1 mm) size fraction.
- Tailings thickeners dewatering the slimes (-0.1 mm) for disposal in the tailings dam.

South Eskom (Destoning) plant

As per the allocation assumptions, coal of less than 45 per cent yield will be directed to the South Eskom plant to fulfil supply requirements to the Dhuva power station.

Coal can be supplied direct from the Middelburg or Wolvekrans mines or from the Vandyksdrift Dump.

All coal entering the South Eskom plant will enter one of three, 3-stage crushing systems and be reduced to a topsize of -40 mm.

Should the coal have a Calorific Value greater than 22.2 MJ/kg, it will be stockpiled ready for transport via overland conveyor to Dhuva.

Coal of a Calorific Value of less than 22.2 MJ/kg will be stockpiled and fed to the destoning plant. Coal entering the destoning plant is screened at 6 mm.

The +6 mm coal entering the destoning plant is processed by a Larcodems separator. Larcodems separators are another form of dense medium separation device used as a lower cost alternative to dense medium baths and drums.

Product coal is stored on the clean coal stockpile while discards report to a silo ready for disposal.

All -6 mm coal bypasses the destoning plant and is combined with the clean +6 mm coal on the clean coal stockpile ready for transport via overland conveyor to Dhuva. -6 mm is not processed but bypassed as 100 per cent product.

A small amount of slurry is produced by the destoning plant. It is thickened and reports to the southern infrastructure tailings cells.

Vandyksdrift Dump mobile plant

Historically, coal washed in the Douglas plant primary circuit (North Export plant) was disposed of at the Vandyksdrift Dump ("VDD"). Recent re-evaluation of this area has shown that the VDD and overlays the future Vandyksdrift Central mining area and hence has been scheduled for re-mining and re-processing. This area has been allocated for a commencement of mining activities in FY25.

SAEC has contracted washing of the VDD coal to Fraser Alexander. The new, mobile VDD plant has a capacity of 1.2 Mtpa ROM and is a standard single stage DMC/Spiral operation.

At the time of writing, the VDD plant was undergoing an expansion to double its capacity to 2.4 Mtpa ROM.

Additionally a tailings filter plant forms part of the expansion to allow tailings to be disposed as dry discard.

By FY17, it is planned that the VDD CHPP will have undergone a further expansion to increase capacity to 4.8 Mtpa ROM.

Historical and forecast operating statistics

During site visits, SAEC expressed its view that the BCP facilities were not being used to full capacity and that export coal production upside exists in the future.

Additionally, discussions with SAEC personnel yielded magnetite consumption as being a major focus for operations to control expenditure. Magnetite is a consumable material and a crucial component in the coal washing process.

An example of the importance of magnetite consumption in controlling coal processing costs is BCP's current year to date (September 2014) magnetite consumption actual costs versus budget. Even though the cost of magnetite reduced such that BCP had gained ZAR1.5 M against budget, magnetite consumption had increased by ZAR6.0 M against budget. As a result, BCP was ZAR4.5 M behind budget to September 2014.

Typical magnetite consumption figures in other mature coal processing markets are:

- Processing coal of ≥ 1.0 mm - ≤ 0.5 kg/ROM tonne of coal.
- Processing coal of <1.0 mm and ≥ 0.63 mm - <1.0 kg/ROM tonne of coal.

The review of historical and forecast operating statistics below, focuses on operational hours and magnetite consumption.

South Export plant

Production statistics for the South Export Plant are listed in Table 5.13 below.

Table 5.13: BCP South Export Plant Production Statistics

Item	Actual FY12	Actual FY13	Actual FY14	Budget FY15
Calendar Hours	8,784	8,760	8,760	8,760
Availability	87%	86%	81%	80%
Utilisation	92%	93%	90%	80%
Total Operating Hours per Annum	7,031	7,006	6,386	5,606
Export Feed kt per Annum	8,354	9,123	8,908	10,424
Plant Feed Rate tph	1,188	1,302	1,395	1,859
Export Yield	53%	53%	48%	41%
Export Saleable Production kt	4,391	4,857	4,278	4,310
Middlings Feed kt per Annum	3,110	2,890	3,789	3,512
Middlings Yield	27%	28%	26%	58%
Middlings Saleable Production kt	842	813	1,002	2,053

Source: SAEC Coal Processing Performance Report – September 2014

While the required hours of operation were met in FY12 and FY13, the plant was fed at a reduced rate. In FY14, operating hours were reduced further but feed rate increased slightly.

Plant capacity is not being fully utilised and as long as Eskom contracts are being met there is upside for export production in the future. An increase in operational hours and subsequent production upside needs to be confirmed with a detailed review of past downtime, future mine production, coal allocation, and the effect of future coal quality on capacity.

At the South Export plant, SAEC has identified power failures as the largest contributor to magnetite losses. Current magnetite losses are 1.5 kg/t ROM resultant of an extensive work program to reduce losses from a previous average of 2.2 kg/t ROM.

North Export Plant

Production statistics for the North Export plant are listed in Table 5.14 below.

Table 5.14: BCP North Export Plant Production Statistics

Item	Actual FY12	Actual FY13	Actual FY14	Budget FY15
Calendar Hours	8,784	8,760	8,760	8,760
Availability	74%	70%	67%	84%
Utilisation	85%	89%	85%	70%
Total Operating Hours per Annum	5,525	5,457	4,989	5,151
Feed kt per Annum	4,962	4,690	3,438	5,204
Plant Feed Rate tph	898	859	689	1,010
Yield	52	47	49	44
Export Saleable Production kt	2,581	2,188	1,694	2,290

Source: SAEC Coal Processing Performance Report – September 2014

Export yields are comparable between the export facilities (North, South and Phola).

BCP's North Export facility is more than 20 years older than the South export facility and therefore runs at a lower operating efficiency due to increase maintenance. Current operating hours are below 6,500 hours and significantly lower than stated in the LOA Plan (7,000 hours). Xstract is of the opinion that there is potential upside for future production of export coal should an increase in operating hours be achieved.

In general, SAEC has advised that typical causes of North Export plant downtime include, no coal, equipment failures (e.g. pumps, conveyor belts), disturbances such as power failures and cable theft.

Xstract noted that there is potential upside to reduce operating costs by reduce magnetite consumption in these plants.

North Middlings plant

Production statistics for the North Middlings plant are listed Table 5.15.

Table 5.15: BCP North Middlings Plant Production Statistics

Item	Actual FY12	Actual FY13	Actual FY14	Budget FY15
Calendar Hours	8,784	8,760	8,760	8,760
Availability	79%	78%	67%	75%
Utilisation	91%	90%	84%	85%
Total Operating Hours per Annum	6,315	6,150	4,930	5,584
Feed kt per Annum	5,489	5,313	4,987	4,586
Plant Feed Rate tph	869	864	1,012	821
Yield	57%	56%	56%	53%
Export Saleable Production kt	3,104	2,959	2,768	2,444

Source: SAEC Coal Processing Performance Report – September 2014

The North Middlings plant has seen a decline in actual operating hours each year since FY12. The SAEC LOA Plan assumes the North Middlings plant operates for 6,400 hours per annum. The FY15 budget of 5,584 hours is significantly below the plan.

While the FY15 budget shows an increase in total operating hours on FY14, the North Middlings plant feed rate has been reduced. This may be to account for lower yielding coal from the dumps but also suggests there may be some upside in production due to not meeting available capacity.

In general, SAEC has advised that typical causes of North Middlings plant downtime include, no coal, equipment failures (e.g. pumps, conveyor belts), disturbances such as power failures and cable theft.

South Eskom plant

Production statistics for the South Eskom plant are listed in Table 5.16 below.

Table 5.16: BCP South Eskom Plant Production Statistics

Item	Actual FY12	Actual FY13	Actual FY14	Budget FY15
Calendar Hours	8,784	8,760	8,760	8,760
Availability	94%	90%	87%	85%
Utilisation	91%	89%	83%	85%
Total Operating Hours per annum	7,514	7,017	6,326	6,329
Feed kt per annum	8,955	8,936	7,463	9,810
Plant Feed Rate tph	1,192	1,273	1,180	1,550
Yield	92%	93%	91%	93%
Export Saleable Production kt	8,198	8,311	6,780	9,129

Source: SAEC Coal Processing Performance Report – September 2014

The FY15 budgeted plant feed rate has increased significantly on the actual FY14 feed rate with similar operational hours. It is not clear whether this is due to an increase in direct feed of coal to Eskom bypassing the destoning plant.

Budgeted operational hours are also well down on FY12 and FY13 suggesting again potential production upside should it be required.

Magnetite losses at the South Eskom plant have been reviewed and progressively reduced from 2.5 kg/t ROM to 0.5 kg/t ROM through the implementation of solutions to water imbalances and a high proportion fine coal entering the processing circuit.

Vandyksdrift Dump mobile plant

Production statistics for the South Eskom plant are listed in Table 5.17 below.

Table 5.17: BCP VDD Mobile Plant Production Statistics

Item	Actual FY14	Budget FY15
Calendar Hours	8,760	8,760
Availability	62%	84%
Utilisation	83%	70%
Total Operating Hours per annum	4,508	5,151
Feed kt per annum	1,349	1,025
Plant Feed Rate tph	298	199
Yield	45.7%	33%
Export Saleable Production kt	616	337

Source: SAEC Coal Processing Performance Report – September 2014

Dump feed is variable. BCP has advised average yield has trended at 38 per cent, however has been as high as 45 per cent.

CHPP power and water

Major issues were noted in relation to continuous power supply and as a result, the plant experiences many non-planned interruptions, which impacts on plant availability, magnetite losses, which in turn impacts operating costs. This is an ongoing situation but is not unusual in the coalfield and there are continual discussions as to the solution.

No issues were reported concerning availability of water. Mostly water is made up from mine production and emergency make-up is available.

Tailings and waste management

BCP North

Coarse discards from the rotary breaker located at the Klipfontein tip are stored in a dedicated discard bin.

Similarly discards from the rotary breakers and North Export and Middlings plants are stored in dedicated bins next to the plants.

All discards are collected by truck for disposal in the mine waste dumps.

Tailings from the North plants are pumped to a dedicated tailings dam located adjacent to the CHPP's. This dam is becoming constrained. As a result, a capital expenditure allowance has been made for the dams expansion in FY16. Current life is two more years (FY16 and FY17) with opportunity to extend. However, an increase in capacity will require additional capital investment.

Options to reduce or relieve this capital expenditure requirement include:

- Pumping tailings directly back to mine voids.
- Preparing tailings for sale as an additive to a 4,800 kcal/kg product through drying and briquetting. SAEC are also investigating recovering tailings from the tailings dam as a part of this project.

BCP South

Coarse discards from the rotary breakers at the Steenkoolspruit tip, Boschmanskrans/Driefontein tip and South Eskom plant tip, are directed to their own dedicated discard bins and then collected and hauled by truck for disposal in the mine dumps.

Similarly coarse discards from the South Export plant discharge into a dedicated bin ready for collection and haulage for disposal in the mine dumps.

Tailings from the South export plant are pumped to one of five tailings cells. These cells are shallow and dug out and disposed once water has been decanted and the tailings dried and disposed as dry discard. Each cell takes approximately four months to fill and seven months to dry. The market is currently being tested for potential slurry sales, which is currently less than 10 per cent of available tailings.

VDD plant

Coarse discards from the VDD plant is stacked on ground and loaded into trucks for disposal at the mine waste/discard dumps. Tailings from the VDD plant is thickened and pumped to abandoned underground workings.

Discussions with BCP personnel during Xstract's site visit yielded that a component of the current VDD plant expansion (to 2.4 Mtpa Feed) is the installation of a tailings filter for dewatering and dry disposal of tailings at the mine waste/discard dumps.

5.2.9 Equipment and manning

Wolvekrans

Equipment

A list of the major mining equipment on site, along with the average age of each equipment type, is shown in Table 5.18.

Table 5.18: Wolvekrans Major Mining equipment fleet

Machine	No's of units	Average Age (hrs)
BE1570 Walking Dragline	3	37,000
Komatsu PC8000 Shovel	2	35,800
Caterpillar 993 Front End Loader	2	17,200
Caterpillar 994 Front End Loader	5	15,100
Caterpillar 793 Haul Truck	10	26,300
Caterpillar 789 Haul Truck	18	22,500
Caterpillar 777 Haul Truck	8	16,900
Caterpillar D10 Dozer	7	15,800
Caterpillar D11 Dozer	10	13,100
Ingersoll Rand DMM2 Drill	1	59,600
Pit Viper PV-275 Drill	6	20,800

Source: SAEC

Manning

The historical manning numbers for Wolvekrans, along with the planned manning for the next three years are shown in Figure 5.20. The manning as shown are full time equivalent (“FTE”) employees and has varied significantly in the last three years. The variance is between 2,106 FTE in FY13 and 1,672 FTE in FY14. The five-year plan shows manning numbers are fairly consistent, varying between 1,698 FTE and 1,872 FTE.

Figure 5.20: Wolvekrans Historical and Forecast Manning

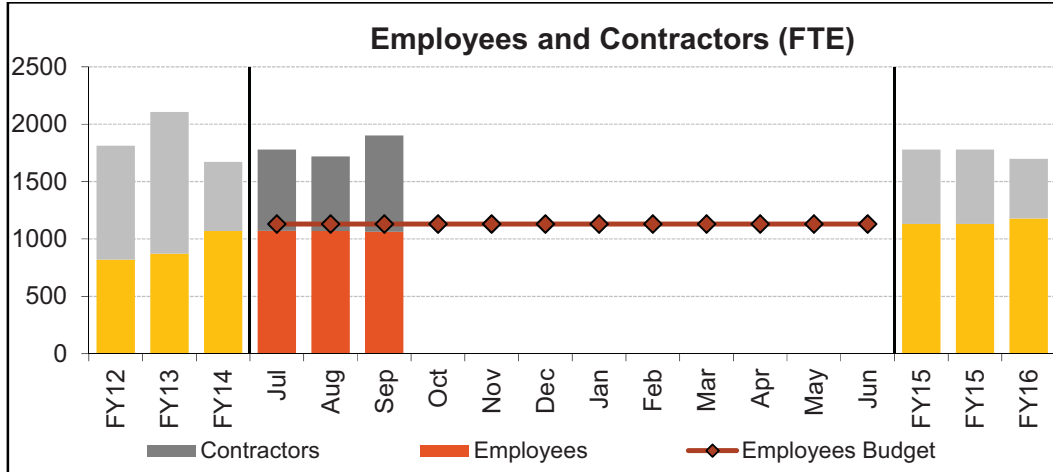

Source: SAEC Wolvekrans_Sep_2014.xlsm

Middelburg

Equipment

A list of the major mining equipment on site, along with the average age of each equipment type, is shown in Table 5.19.

Table 5.19: Middelburg Major Mining equipment fleet

Machine	No's of units	Average Age (hrs)
BE1570 Walking Dragline	2	238,000
Caterpillar 993 Front End Loader	1	12,800
Caterpillar 994 Front End Loader	2	14,800
Caterpillar 785 Haul Truck	9	6,900
Caterpillar D10 Dozer	2	37,300
Caterpillar D11 Dozer	6	11,500
Pit Viper PV-275 Drill	4	17,800

Source: SAEC

Manning

The historical manning numbers for Middelburg, along with the planned manning for the next three years are shown in Figure 5.21. The manning as shown are full time equivalent (“FTE”) employees and has varied between 1,009 FTE in FY13 and 935 FTE in FY14. The five-year plan shows manning numbers remaining constant at 900 FTE.

Figure 5.21: Middelburg Historical and Forecast Manning

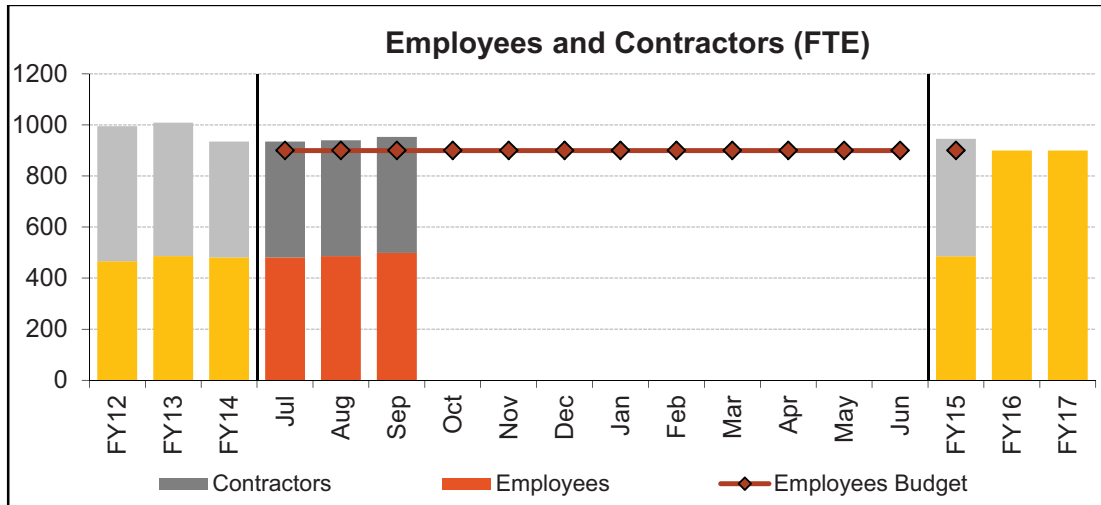

Source: SAEC Middelburg_Sep_2014.xlsm

BCP

Table 5.20 shows historical and FY15 budget manning levels at BCP.

Table 5.20: BCP Historical and Budgeted Manning Levels

Type	Actual FY12	Actual FY13	Actual FY14	Budget FY15
Employee	509	567	609	631
Contractor	694	679	794	553
Total	1,203	1,246	1,403	1,184

Source: SAEC Coal Processing Performance Report – September 2014

As at September 2014, the approximate total number of personnel on site at BCP was 1,400 (well above the FY15 budget). Employee numbers were held to budget, the difference being the number of contractors on site.

BCP records show that the following contractors were working at BCP as at September 2014:

- Fraser Alexander
- Steffanutti Stocks
- Scribante
- Legare Mining Services
- Mpembe
- Maintenance contractors – various.

5.2.10 Management and Industrial Relations

During the review, the Xstract project team were in regular contact and held numerous discussions with all levels of SAEC management. Based on this contact, Xstract is satisfied that SAEC has established a capable management team at both Wolvekrans and Middelburg Collieries, that the coal mine management understands the key drivers and risks at the mine and have developed credible systems and operational plans to manage the mine

effectively. SAEC has established a technical services group, which coordinates LOA mine planning and comprises of geological, mining engineering and environmental management.

5.2.11 Health and Safety

Wolvekrans

Xstract understands that an executive safety committee sets health and safety management policy within SAEC. Direct health and safety responsibility rests with the line management and, as is essential in the effectiveness of any system, relies on workforce involvement.

Safety performance in the last three years at Wolvekrans has steadily improved. Figure 5.22 shows a number of safety measures and highlights the steady reduction in Injury Frequency Rate ("TRIFR"). The historical TRIFR results for FY12, FY13 and FY14 are 4.29, 3.2 and 1.87 respectively. These results are primarily a result of the reduction in recordable injuries, which is a good result and the preferred outcome from safety initiatives. The number of recordable injuries for FY12, FY13 and FY14 respectively were 14, 12 and 7 respectively, so a significant improvement over the three years.

During the site visit by Xstract, safety was observed to be at the forefront of the operation and reflective of the safety culture that exists within BHP Billiton operations.

Figure 5.22: Wolvekrans Mine Safety Performance

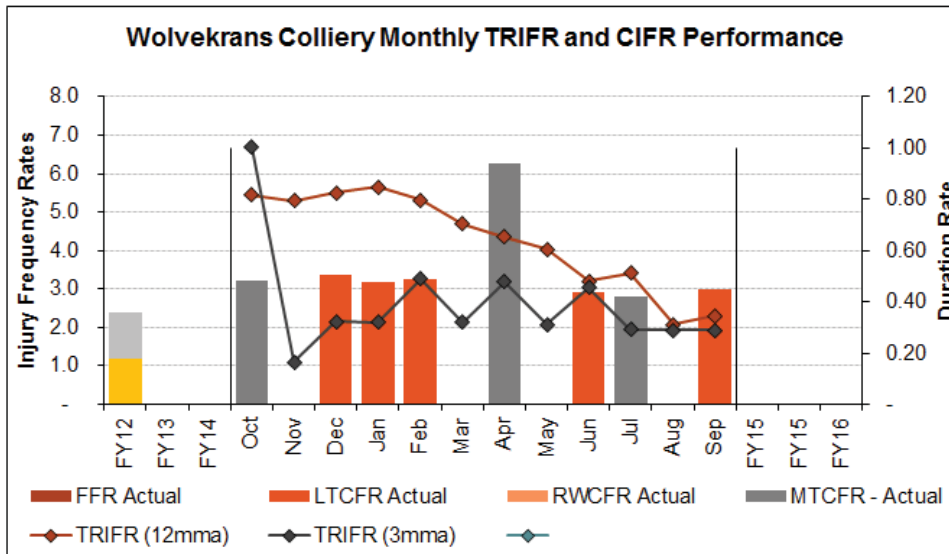

Source: SAEC

Middelburg

Safety performance at Middelburg in the last year, as expressed in Injury Frequency Rate, declined as shown in Figure 5.23. The TRIFR has increased from 1.6 to 2.7 over the last 12 months. This is the result of five reportable injuries over the 12-month period, with all five of those injuries being suffered by employees of contractors. No reportable injuries for SAEC employees over that time period is a worthy achievement and reflects the strong safety culture at the mine site. However, the number of injuries suffered by contractors does suggest further work is required in this area.

The current TRIFR twelve month moving average is 2.7, which compares favourably against FY12, FY13 and FY14 averages of 2.76, 1.61 and 3.16 respectively.

During the site visit by Xstract, safety was observed to be at the forefront of the operation and reflective of the safety culture that exists within BHP Billiton operations.

Figure 5.23: Middelburg Mine Safety Performance

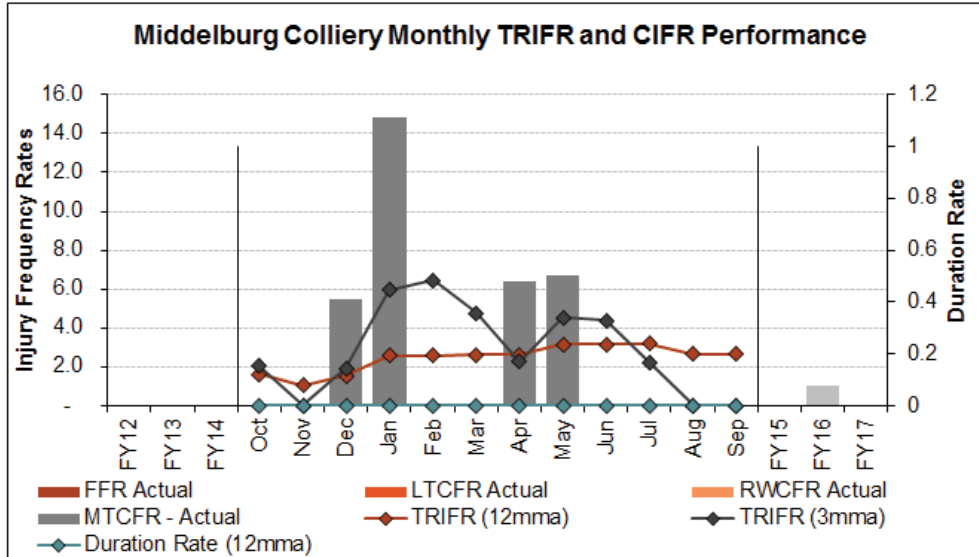

Source: SAEC

5.2.12 Infrastructure and Transportation

BCP crushing, conveying and reclaiming systems

Overland conveyors are an integral component of the coal transportation and logistics system at BCP. There are approximately 160 km of conveyors across the site. Domestic product is transported via conveyor belt from the Dense Media Circuit (“DMC”) to Eskom’s Duvha power station.

As a part of its FY15 five-year plan, SAEC is making progress in identifying and solving bottlenecks in the crushing and conveying system.

Water

The Wolvekrans-Middelburg Complex (including BCP’s coal processing facilities) receive water from Eskom’s Usutu Vaal Scheme, which supplies potable water at an average of 30 MI/month. Additionally, process water is sourced from pollution control dams, which have a combined volume in excess of 1,000 MI.

A potable water supply contract is in place with Eskom. SAEC has water abstraction permits with the DWS.

The Middelburg water treatment plant is currently under construction and will start treating water in 2015.

Power

Wolvekrans Mine has a dedicated power supply to support mining operations with 6,800 MWH per month, 12 MVA maximum demand usage and 15 MVA notified maximum demand.

Middelburg Mine has a dedicated power supply to support mining operations with 4,200 MWH per month, 10 MVA maximum demand usage and 16 MVA notified maximum demand.

SAEC's LoA plan for both Wolvekrans and Middelburg suggests that the power required to carry out mining operations can be met by the current system.

Roads

The entire Wolvekrans-Middelburg Complex is easily accessible from numerous established national roads and serviced by well-established electrical infrastructure. A network of haul roads and ramps connect the various working areas of the mine, while 160 km of conveyor belts connect the mining operations to the five wash plants within the mine boundaries.

Railway

The Wolvekrans-Middelburg Complex has both an internal railway system and external rail linkages.

Internal rail

BCP has an internal rail system that allows ROM coal transfer between the North and South Plant sites. The rail system has a maximum ROM/raw coal transfer capacity of 4 Mtpa in either direction.

BCP has advised Xstract that locomotives and wagons require an overhaul to maintain this transfer capacity was scheduled to occur in FY15. However due to current capital constraints, this has been deferred to next financial year. These costs will be included in FY16.

BCP Export Product Stockpiling

The Northern Plant train loadout stockyard can store approximately 80,000 t of export coal as live capacity and can stack out an additional 80,000 t of export coal as dead/emergency capacity that requires dozer recovery.

The Southern export plant has 150,000 t of live stockpile capacity.

Reclaimed coal from the north and south enters the export train load-out silo, which has a capacity of 9,000 t. As they are separate stockpiles and feed the silo from separate conveyors the north and south stockpiles can feed the silo at the same time.

Each train has a capacity of 8,400 t and is loaded on average in four hours.

In its review of rail constraints, SAEC recommended that coal stocks fall no lower than 60,000 t and that a target stock level of 180,000 t is maintained. It has also recommended that total export stockpile capacity be increased to 300,000 t.

BCP is currently investigating the expansion of the Northern train load-out stockpiles to 160,000 t of live capacity through modification of the portal reclaimer to allow it to reclaim from the emergency stockpile.

VDD train loadout

Product coal from the VDD CHPP is sold to Eskom or to the export market.

Export coal is stored in silos and loaded on to trains via a refurbished train loadout system.

Currently two trains a week are loaded from the VDD system with an average 4-hour turnaround.

It is expected that the number of export trains will increase to 11 per week once the VDD CHPP reaches its intended feed capacity of 4.8 Mtpa in FY17.

External rail linkages

As shown in Figure 5.24, SAEC has full access to the Transnet Freight Rail ("TFR") system with a contract in place to FY24 for coal haulage through to RBCT. SAEC owns a 21 per cent interest in RBCT, which provides for a proportionate (i.e. 21 per cent) rail and port allocation on an annual basis.

Figure 5.24: Rail infrastructure linkages from SAEC's operations to RBCT

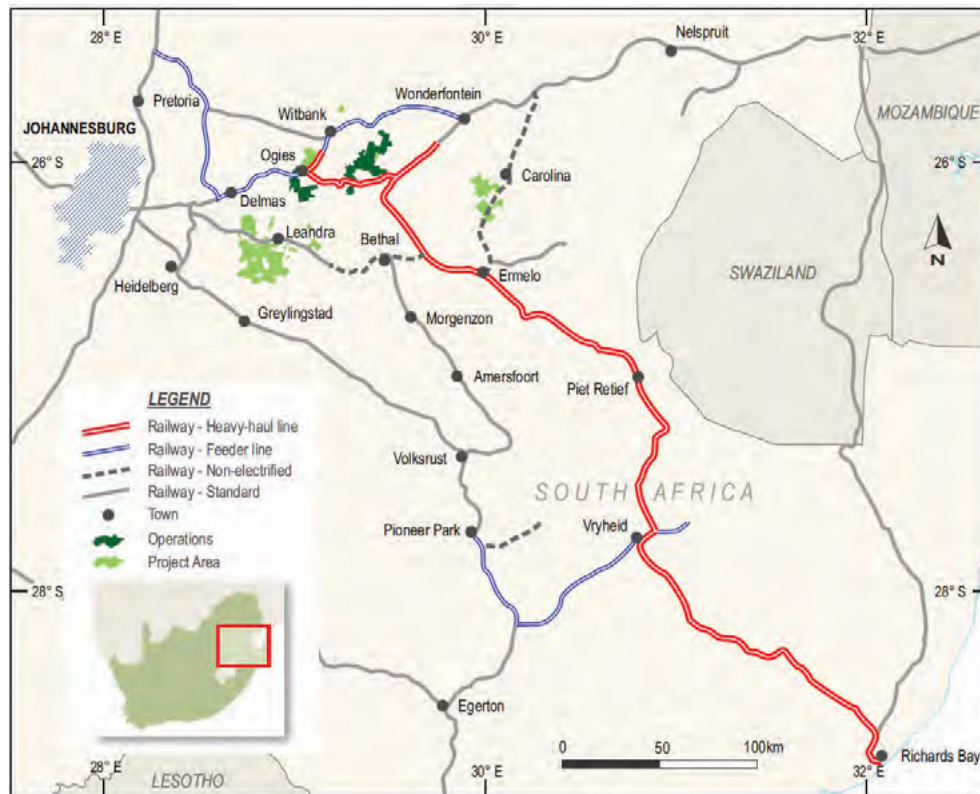

Source: Transnet, Xstract

SAEC's prioritises its rail allocation internally on the following basis:

- Klipspruit Mine is allocated first and to the full available performance of the current fleet. Currently not constrained by plant or load-out.
- Remaining TFR allocation is assigned to WMC coal – first using owner capacity then added to as necessary with contractor capacity.
- Adding any remaining flexible capacity with third party buy-ins.

A major focus of SAEC’s FY15 five-year plan is the train system and ensuring minimal train cancellations initiated by SAEC. A key part of this plan is to improve internal logistical coal flow by:

- Identifying minimum and target export stock levels.
- Removing internal transportation bottlenecks.
- Taking advantage of internal available transportation capacity (i.e. internal rail).
- Increasing live export stockpile capacity.

SAEC’s FY15 plan to fill the TFR allocation with saleable coal is presented in Figure 5.25.

Figure 5.25: SAEC’s saleable plan to fill TFR allocation

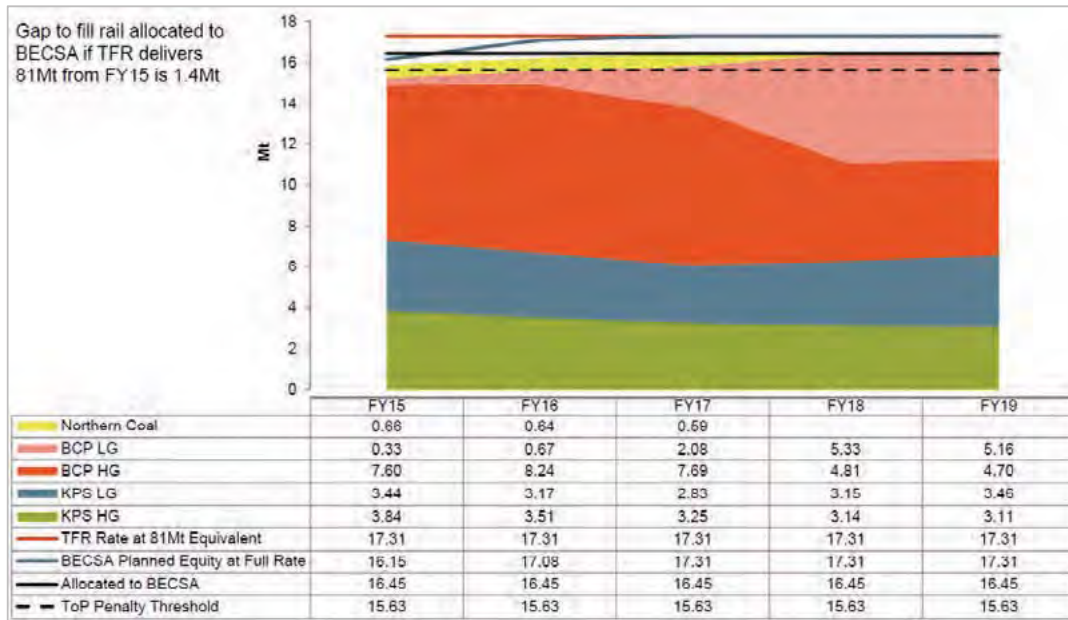

Source: SAEC

TFR have not delivered rail capacity of 81 Mtpa over the last 10 years. There has however been a trend over the last 5 years of improved performance year on year, with a 16 per cent, or 10 Mtpa, improvement between tonnes moved in 2004 and 2013. TFR anticipate a further 3 per cent increase in tonnes moved for FY14. Figure 5.26 shows the actual performance for TFR since 2004. Xstract understand that a new contract between SAEC and TFR has a Take or pay aspect.

Figure 5.26: TFR Rail Performance

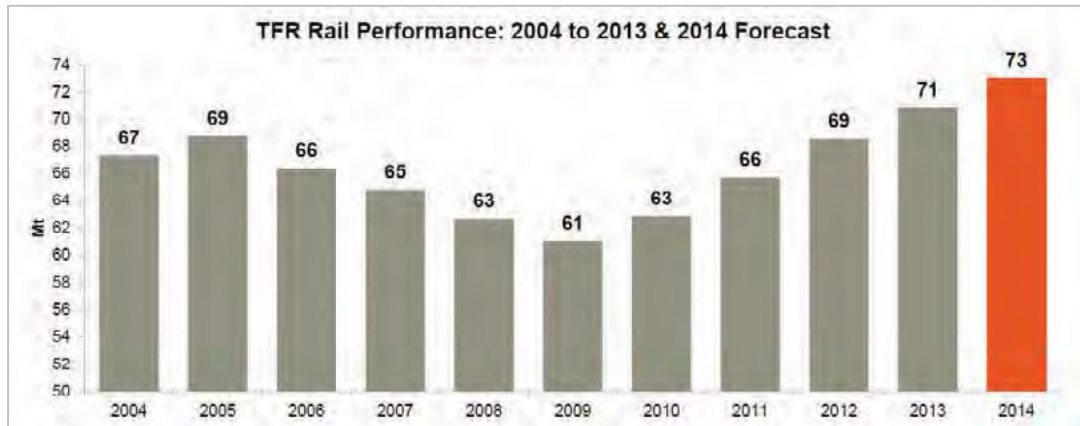

Source: SAEC Presentation, "BCP_Marketing_20141020"

Port

SAEC owns a 21 per cent interest in RBCT, which provides for a proportionate (i.e. 21 per cent) port allocation on an annual basis. RBCT currently has a capacity of 91 Mt annually. SAEC therefore has theoretical access to a maximum of 19.9 Mt of coal capacity annually. However, the throughput rate is capped due to the rail capacity of 81 Mtpa and this entitles SAEC to a throughput rate of 17.3 Mtpa to RBCT, which will remain unchanged at a different shareholding unless SAEC take up additional shares

Key risks for SAEC's port infrastructure include aging plant and equipment that is showing signs of metal fatigue and needs replacement (in particular Stacker Reclaimer 1 and 2 at RBCT) and electrical power supply by Eskom, which is at risk of failing.

5.2.13 Marketing

Domestic

SAEC's WMC operations supply a 22.7 MJ/kg coal to Eskom's Duvha power station. Pricing to Eskom is on a fixed-price plus annual escalation basis, with terms of supply until 2022, with a further 10-year option.

In addition, SAEC supplies coal to local traders on a negotiated basis, with terms of these sales ranging from spot sales to more than 12 months.

Export

SAEC has off-take agreements in place with nine existing customers for its 4,800 kcal/kg, and Benchmark products from the WMC, which are exported via RBCT.

5.2.14 Environment and social

Environmental and social status

Primary environmental impacts at WMC are typical of opencast coal mining operations throughout the region and mainly relate to groundwater pollution, changes to the surface water regimes and associated impacts on wetland areas, land disturbance, noise, blasting, and air quality. When mining coal pillars, spontaneous combustion of the coal and overburden may occur, impacting air quality and greenhouse gas emissions.

Community relations, plans and programmes

SAEC has extensive Community Development Initiatives, with multiple Local Economic Development (“LED”) projects in the areas of health, housing, training and farming.

SAEC’s significant contribution to community development programs is acknowledged and supports the Company’s social license to operate at WMC. In addition, the Company’s community programmes are in line with its commitments under the Social and Labour Plan (“SLP”) for the WMC.

Permitting requirements

SAEC has obtained the necessary primary licenses and authorisations to proceed with mining and associated activities at WMC. With the evolution of this complex, there are overlapping licenses, authorisations and permits. This is common in coal mining districts, where mines have been amalgamated over time.

SAEC holds approved EMPr’s which are duly stamped and authorised. However, it has now compiled a consolidated EMPr as per the DMR’s instruction and submitted to the DMR for authorisation. This consolidated EMPr is designed to make the environmental management of WMC simpler and more manageable. Consolidated EMPr’s take a significant amount of time to gain approval from the DMR, and the fact that its approval remains pending is not currently seen as a risk to the ongoing operations as they have exiting authorisations.

Currently, environmental performance assessments are being performed by independent consultants every second year against the proposed consolidated EMPr. The performance assessments have been submitted to and accepted by the DMR. Thus, the mine is legally compliant with regards to the submission of these performance assessments.

Where licenses have expired or are expiring soon, applications for renewals have been submitted.

For the most part, WMC is complying with its legal obligations, and there is minimal risk of the authorities halting mining activities due to legal non-compliance.

To accommodate future mining plans, a significant number of additional environmental and mining authorisations are required.

Potential Impacts, Control Measures and Environmental Management

Water Management

Water management is important at WMC. At Middelburg Mine, this is critical to access workings as per the mine plan. There is an excess of water in the northern deposits and dewatering is required before these areas can be accessed, particularly Hartebeesfontein and Goedehoop. There is a 20 MI/day desalination plant being constructed to treat and discharge water from these workings, but this will only be operational in approximately 8 months’ time. In the short-term, water is being evaporated using water burners/evaporators to reduce the volume of water from the underground workings.

SAEC has provided ZAR 1.68 Bn to build a reverse osmosis plant to treat 7,060 MI/annum. In the longer term, there is operational or closure provided for in 2035, 2036 and 2037 to do passive and semi-passive treatment. It is planned that the RO costs will no longer be required and that there will be active movement to passive systems, which will reduce water make.

Rehabilitation

WMC has a disturbed area of approximately 7,000 ha. There are plans in place to rehabilitate this area over time. For the next four years from FY14 to FY18, there is a commitment for rehabilitation to occur at the rate of 600 ha per annum. The additional disturbance during this time varies between 2 and 300 ha per annum, leading to a net reduction in the total area disturbed. The total area disturbed is to be rehabilitated by FY44. Figure 5.27 outlines the planned rehabilitation and the areas to be disturbed.

Figure 5.27: Total area disturbed and Land rehabilitated vs land disturbed at WMC

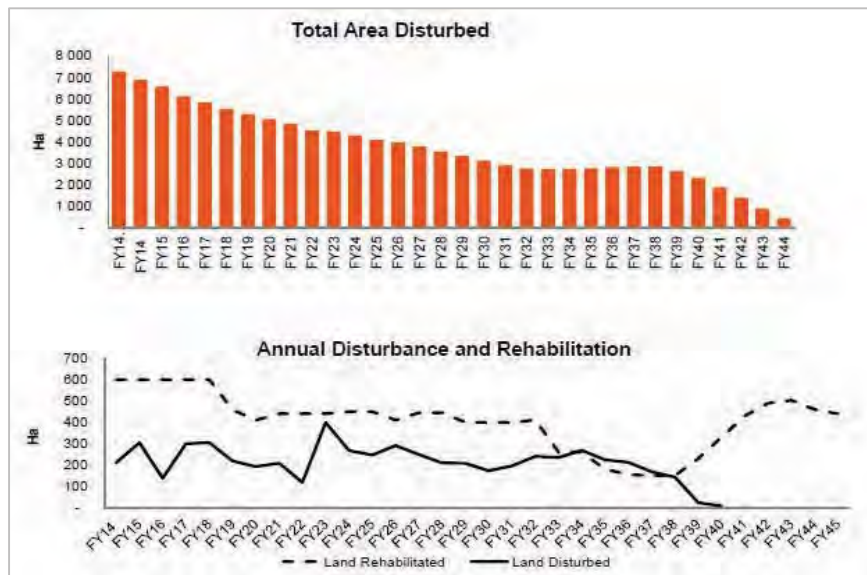

Source: SAEC, 2013

WMC’s planned expenditure on closure, rehabilitation, closure water treatment and retrenchment costs are shown in Figure 5.28. This forecast incorporates surface reclamation, expenditure on water treatment (excluding that required for access to mining areas) and planned expenditure on redundancy on the closure of the operations. The planned expenditure on rehabilitation approximates to roughly ZAR500,000 per hectare. The water treatment costs are for operational costs and the occasional capital expenditure.

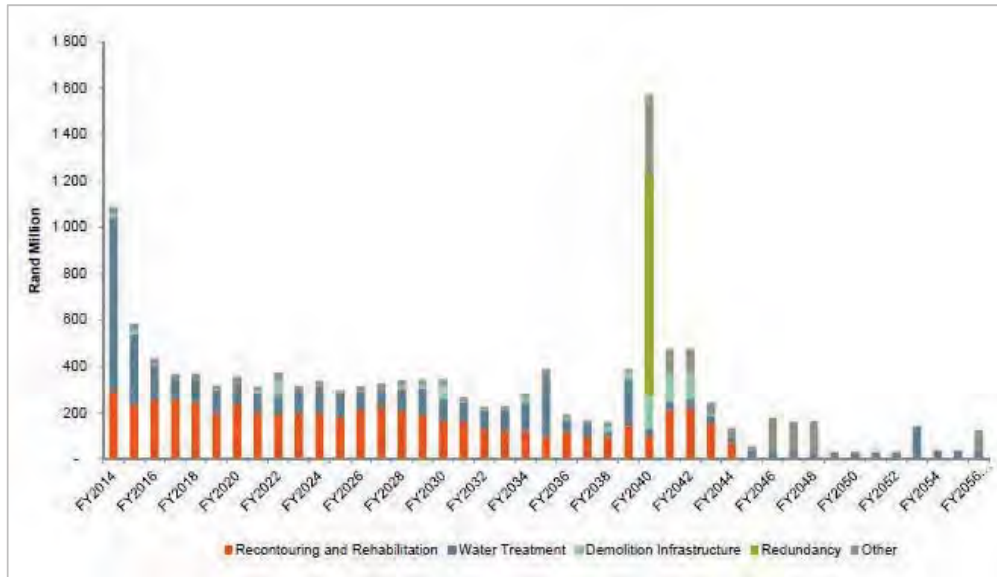
Figure 5.28: Proposed expenditure on rehabilitation at WMC (ZAR M per annum)

Source: SAEC

Closure planning

SAEC's Closure Plan for WMC as at 30 June 2013 assesses a Deterministic Closure Liability quantum amounting to ZAR4.47 Bn. The closure liability provides for the demolition of infrastructure, water treatment, removal of roads and railway lines, etc.

At a first pass, this quantum is in line with expectation for an operation of this size, with the associated environmental liabilities and without having undertaken a detailed review, is deemed appropriate and sufficient.

SAEC's Closure Plan notes that Xstrata (now Glencore) has a rehabilitation and water liability for the North section of Middelburg Mine and Eskom has some rehabilitation and water liability on the South section. The closure schedule states that the closure of the mining operations is planned in FY40, but that 80 per cent of all areas disturbed during mining will be rehabilitated on a continuous basis as part of concurrent mining.

Spontaneous combustion

There is spontaneous combustion at various areas within former underground mine workings within the WMC. When the previously mined voids are exposed by dragline, there is a propensity for these workings to combust. Combustion is controlled by a combination of buffer blasting ahead of the current open strip and by dozing a sealing layer of inert soft overburden over the exposed burning overburden to prevent excessive air ingress. These techniques are reasonably successful and should not prevent the future extraction of coal from previously mined areas.

5.2.15 Cost assumptions

Operating costs

Mining costs

Xstract has compared projected costs against historic mining costs provided by SAEC and benchmarking against comparable mining companies. Xstract considers the real average waste removal cost of ZAR20.46/bcm and coal mining cost of ZAR78.84/t Prod over the life of the Coal Reserves as estimated by Xstract to be appropriate as listed in Table 5.21.

Table 5.21: Wolvekrans-Middelburg – real average mining cost

Item	Unit	Actual FY12	Actual FY13	Actual FY14
Waste Removal	ZAR/bcm	22.58	26.28	27.55
Mining	ZAR/t Prod	66.17	72.47	77.23

Source: SAEC, Xstract estimates

Table 5.22: Wolvekrans-Middelburg – forecast mining cost (real)

Item	Unit	FY15 H2	FY16	FY17	FY18	FY19	FY20-38
Waste Removal	ZAR/bcm	18.95	19.85	20.78	22.15	23.68	22.16
Mining	ZAR/t Prod	96.01	72.79	72.85	82.04	77.85	73.87

Source: SAEC, Xstract estimates

Processing costs

BCP is responsible for all coal handling and preparation at WMC, producing an average overall yield for the life of the operation of 75 per cent. The real average life of Reserves processing cost is estimated at ZAR45.76 per ROM tonne. Based on analysis of BCP historical costs, Xstract considers this appropriate for this South African operation based on the review of the historic data.

Table 5.23 the progression of operating expenditure at the BCP. Actual costs are shown for FY12 to FY14 and budgeted costs for FY15.

Table 5.23: BCP Actual Operational Expenditure

Item	Actual FY12	Actual FY13	Actual FY14
Opex (ZAR/t ROM)	46.48	48.83	55.16

Source: SAEC Coal Processing Performance Report – September 2014

Table 5.24: BCP Forecast Operational Expenditure (real)

Item	FY15 H2	FY16	FY17	FY18	FY19	FY20-38
Opex (ZAR/t ROM)	48.08	48.15	47.11	51.12	53.18	69.38

Source: Xstract estimates

When compared with costs from Phola (refer Section 5.3.15), the BCP costs are between ZAR20 and ZAR29/t ROM higher.

BCP’s operating costs include expenses for transportation and logistics (including the internal rail transporting coal between the north and south complexes) that are not incurred at Phola’s smaller operation.

A key consideration when examining operating costs for BCP is that it appears BCP is not using the full capacity of the facilities and an increase in tonnes being processed will drive operating costs down on a ZAR/t ROM basis.

Port and transportation costs

The rail transport from WMC to RBCT is carried out under a fixed price contract (ZAR/t) that is escalated annually. This rate is inclusive of the port handling costs at RBCT. Xstract has assumed that any unutilised spare rail and port capacity will be sold to a third party not affecting the value of the Reserve as a penalty.

Domestic coal sold to Duvha power station is transported by conveyer. The cost is included in processing costs.

Total cash costs

Figure 5.29 illustrates the real cash costs of the scheduled Coal Reserves over the Life of the Reserves. Total mining costs account for 45 per cent of total operating costs of which two thirds of total mining costs is waste removal. The next largest cost is administration and overhead costs at 23 per cent that include both site overheads and SAEC corporate costs.

Figure 5.29: Real cash costs over Life of Coal Reserves

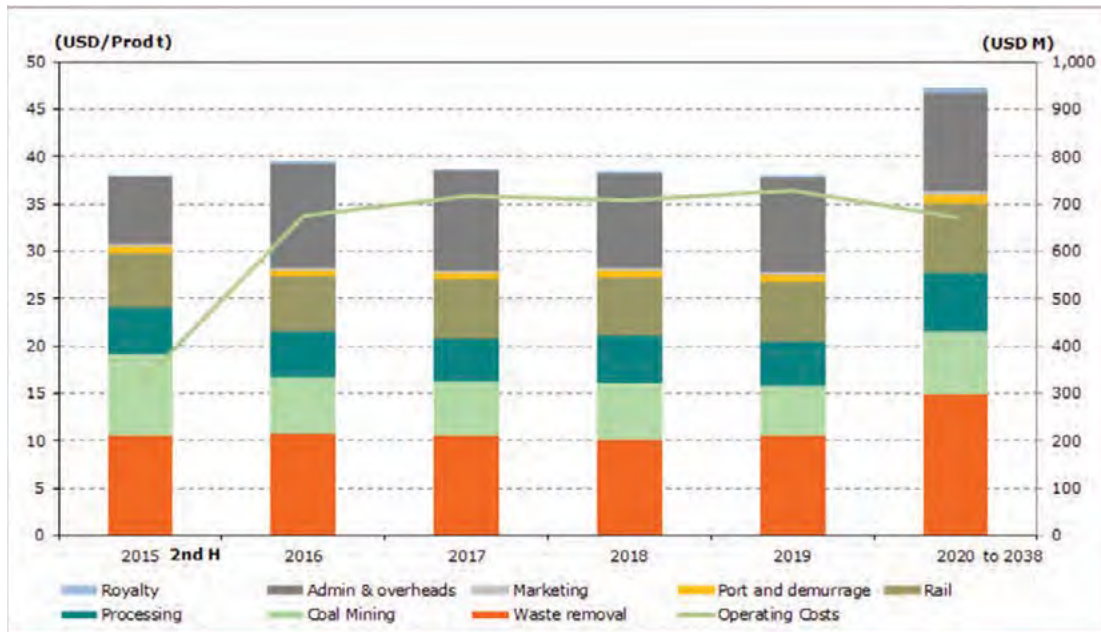

Source: SAEC, Xstract estimates

Capital expenditure

Project capital expenditure for WMC is estimated at USD575 M (real). This expenditure includes new project developments, such as Vandyksdrift at Wolvekrans in FY18 and FY19 (Figure 5.30).

Sustaining capital expenditure for refurbishment of plant and mining equipment is estimated at USD965 M over the Life of the Reserve.

Figure 5.30: Capital expenditure profile of WMC

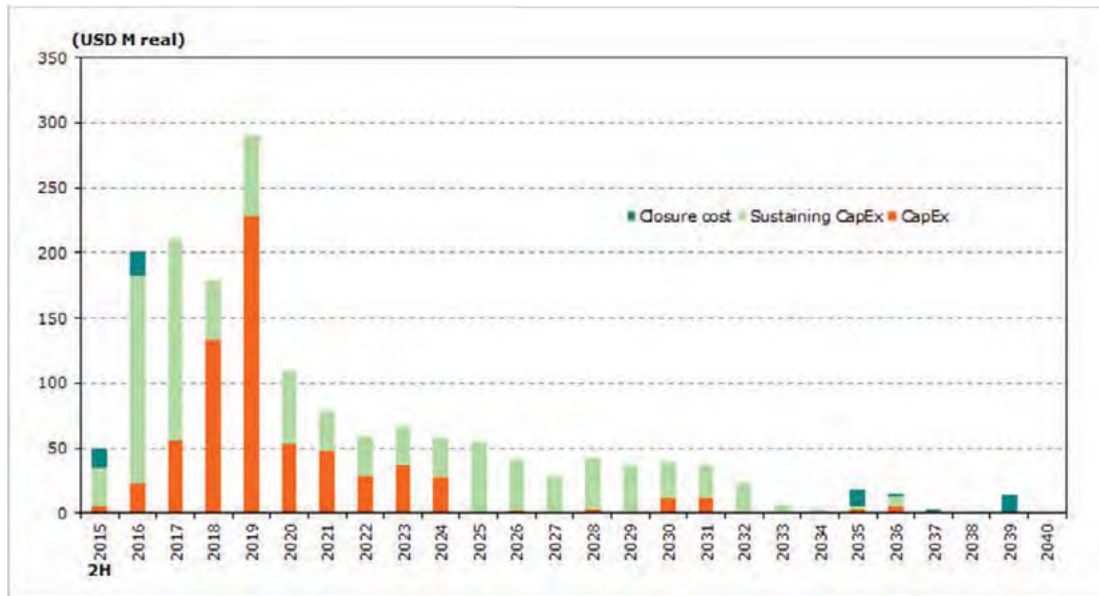

Source: SAEC, Xstract estimates

Closure costs

Closure costs were allocated to operating costs as rehabilitation that takes place concurrent to mining. An estimate for redundancies is included in the final year. Salvage value of plant is not considered material and no allowance has been included.

A further closure cost estimate of USD73 M spent mostly in the final years of mine life has been capitalised based on demolition of the processing plants, administration blocks and rehabilitation of final voids and ramps.

5.2.16 Risk and opportunities

Risks

Geology

The key geological risk relates to encountering unidentified steep floor rolls and structural complexities related to igneous intrusions. Although these are likely to result in a discount of Coal Resources, they are not considered material to the LOA plan.

Mining

At Wolvekrans, production is forecast to double over the next 10 years. These forecasts are based on the Company achieving significantly higher productivity levels than has been

achieved historically, but below rates evidenced at other BHP Billiton-operated sites internationally, as well as other third party-owned operations in South Africa. As such, there is a risk that forecast efficiency gains may not be realised and that forecast production rates are lower than currently forecast. Achievement of the forecast rates will require active and on-going management. There are additional plans to increase the fleet size, which will require extra capital to improve production capacity.

The mining of remnant pillars involves inherent risks associated with the conversion of Coal Reserves and production. Stated Coal Reserves at Wolvekrans may need to be depleted due to spontaneous combustion in future, if the risk is not well managed.

On-going water management may also affect production rates, and while certain assumptions have been made in the Reserve model, loss and dilution of the coal may be higher than expected, resulting in lower tonnages than currently forecast.

The current LOA plan includes a significant Inferred Resource component in VDDS and Albion areas. There is a small risk that these defined Inferred Resources do not readily convert to Coal Reserves as envisaged. Historically, SAEC's conversion rate has been relatively high.

Processing

Key risks identified with future operations at BCP include:

- Conveyor belt damage: As previously identified the BCP facilities contain approximately 160 km of conveyor belts, the continued operation, which are essential for the movement of coal around the site and for delivery to clients.

Future open cast mining of previous underground workings presents risk of conveyor damage by underground roof bolts from old workings.

- Theft: Cable theft has been identified by BCP as a key risk to operational performance. For example SAEC highlights cable theft as one of the main causes of interruptions to power supply and downtime for BCP.

Discussions with site personnel also identified that theft of polyurethane pipe, used mainly for the transportation of water around the mine site, was becoming more frequent.

Environment

Risks primarily relate to the LOA plan not being achieved due to environmental factors and permissions, as well as pillar mining factors. These include:

- De-watering of the underground workings at Wolvekrans
- Mining on top of stacked underground pillars at Wolvekrans
- Obtaining environmental permissions and water use licences in the period available at Middelburg and Wolvekrans.

Opportunities

Mining

Coal Reserves could be significantly increased through the conversion of the VDD and Albion Inferred Resources, which form part of the current LOA plan at Wolvekrans. Further potential additions to Reserves within the near term include the conversion of the stated Measured and Indicated Resources at KSPX and of the Khutala Coal Resources to Reserves.

Currently the operating efficiency of the truck and shovel operations are well below best practice and there is an opportunity for improvement, which will reduce operating costs and improve overall mine production. SAEC are reviewing their WMC operation to improve the mining method from dragline only to a mix of truck and shovel and draglines so as to enhance the coal production by improving coal exposed inventory. SAEC is currently planning to increase the truck and shovel fleet over the next 10 years. Xtract has in the valuation taken operational improvements into account.

There are opportunities to enhance the production at WMC through further investigations into mining coal below the current cut off thickness of 1 m. Throughout the world coal mining companies use a practical mining cut off of around 0.3 m coal thickness (depending on economics). SAEC are currently working on reviewing their cut off limits

Processing

Opportunities identified for future operations at BCP include:

- Improving available operating hours: There is potential for improvement in availability and utilisation of key equipment to remove bottlenecks to allow BCP to take advantage of latent processing and transportation capacity.

SAEC has advised that typical causes of plant downtime include, no coal, equipment failures (e.g. pumps, reclaimers, conveyor belts), disturbances such as power failures (both BCP and Eskom related) and cable theft.

While Eskom related power failures as well as those related to storms and lightning are beyond SAEC's control, attention to improving BCP related power failures will provide improvement in plant availability and reduce consumables losses.

- Improving magnetite recovery: SAEC has undertaken a comprehensive review of magnetite losses in the BCP processing facilities and has implemented programs to improve recovery. Large improvements in recovery have been achieved, however, looking at the causes of losses that are still within SAEC's control it appears there is room for more improvement.

5.3 Klipspruit

Klipspruit is an opencast bituminous coal mining and processing operation located at latitude 26°2'22" South and longitude 29°1'17.35" East, in the Ogies district of the Nkangala District Municipality in Mpumalanga Province. The operation comprises:

- the Klipspruit Mine, which is wholly owned and operated by SAEC, is divided into the Smaldeel, Bankfontein and Klipspruit South working sections; and
- the Phola Coal Processing Plant, which is held via a 50:50 joint venture with Anglo Coal, a subsidiary company of Anglo American (Pty) Ltd.

The Klipspruit Mine lies immediately west of the town of Ogies, 3 km southwest of the town of Phola and is some 30 km southwest of Witbank. Ogies (population approximately 1,500) functions as a service centre to local farmers, with a number of service industries and the co-operative focusing specifically on the agricultural sector. Rail and bus services link Ogies to other centres throughout Mpumalanga Province and South Africa.

Klipspruit is bordered by the N12 National highway to the north and Eskom's Kendal Power Station to the southwest. The mine is easily accessible from the N12 National highway and the R555 and R545 provincial roads. The Richards Bay Rail Line passes through the southern portion of the mine area. SAEC's Khutala Mine lies immediately adjacent and to the south of Klipspruit.

5.3.1 Land tenure

The farm properties and mineral rights comprising the Klipspruit operation and its related legal tenure are summarised in Figure 5.31, Table 4.3 and Appendix B. The mineral and surface access rights are sufficient for all aspects of the mining and processing operation.

Figure 5.31: Klipspruit Mining Rights and Surface Rights

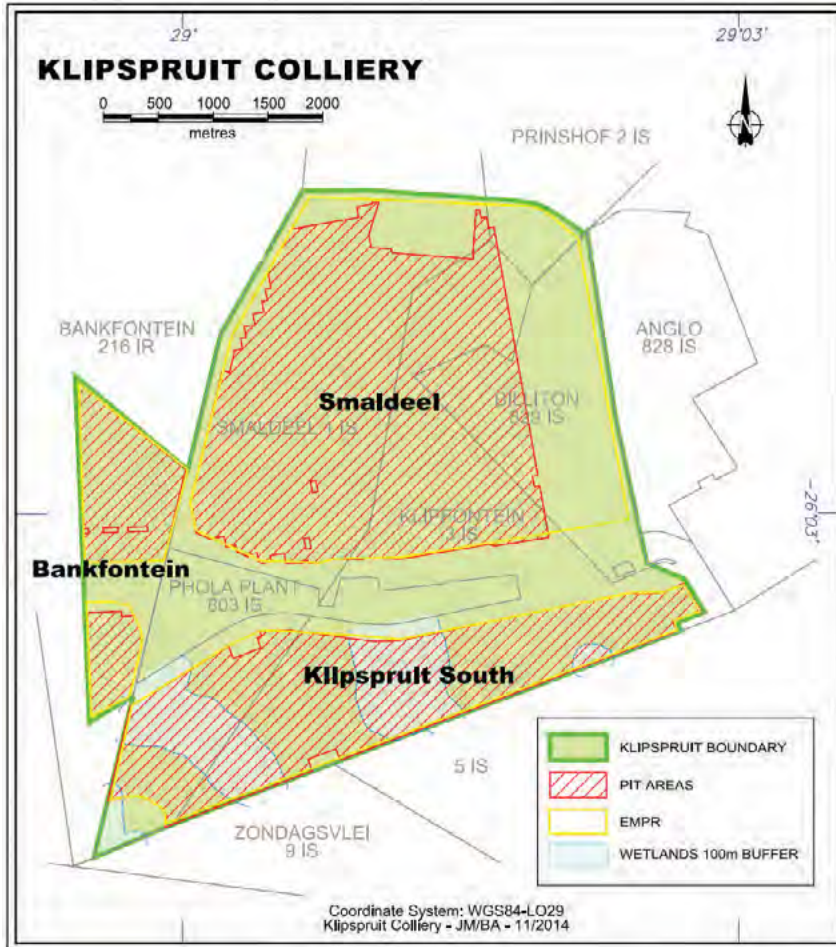

Source: SAEC

Material agreements

The Phola processing plant operates under a 50:50 joint venture agreement between Anglo American Inyosi Coal (Pty) Ltd ("Anglo Inyosi") and SAEC. The plant operates on a time use basis with all rejects currently managed by SAEC and disposed of in the Klipspruit open pit at an agreed contract cost.

In order to access the Phola plant, SAEC and Anglo Inyosi have an agreement relating to Anglo Inyosi's conveyor system, which impacts on the Klipspruit Mining Right. Under the terms of the agreement, Anglo Inyosi has the right to use the conveyor system until 2019, after which time SAEC can request it to be moved or removed.

As outlined earlier, production from Klipspruit is transported from the mine to Richards Bay Coal Terminal under a rail entitlement agreement with TRF.

There are two main operating contracts in place at the Phola processing facility, with Minopex (Pty) Ltd operating the Phola Coal Handling and Processing Plant and Coallab (Pty) Ltd Phola operating the laboratory.

5.3.2 History

Ownership

The Klipspruit mine is wholly owned and operated by SAEC.

Project development

Klipspruit is SAEC's newest coal mine and was initially approved by the Mpumalanga Department of Agriculture, Conservation and Environment in 2003. It was initially designed as a stand-alone greenfields project, however Ingwe also considered it as an extension to its existing Khutala operation.

An initial mini-pit mining operation commenced in August 2003 as a truck and shovel contractor operation developing a box-cut to access the No.2 and No.4 seams with some No.5 seam material. Initial production volumes were limited (i.e. reported sales in 2004 were 564 kt) and comprised mainly bulk samples. A total of 32 samples were collected over an 18 month period for washability analysis pending the development of the Phola plant. During this initial period, coals were transported 34 km to the Rietspruit wash plant. In June 2005, the Klipspruit dragline was installed.

SAEC approved full development of the standalone Klipspruit Mine in 2006.

In December 2007, SAEC formed a 50:50 joint venture with Anglo Coal to construct the Phola Coal Processing Plant on the Klipspruit Mine. This joint venture resulted in a doubling in size of the conceptual Phola plant in order to accommodate production from both Klipspruit and Anglo Coal's adjacent Zibulo opencast mine and subsequently from the Zibulo underground mine, approximately 15 km to the south. The new plant concept was capable of handling 16 Mtpa of coal, half from each of the partners. It includes ROM storage and materials handling systems, domestic and export product storage, rail lines and two rapid rail load-out stations.

First coal was produced from Phola in June 2009, which resulted in closure of the Rietspruit wash plant in early August 2009. The commissioning of Phola facilitated the expansion of the Klipspruit Mine to full production of 8 Mtpa in 2009.

Recent production history from Klipspruit is discussed in Section 0.

5.3.3 Local geology

The topography of the Klipspruit area is generally flat to gently sloping, at a mean elevation of approximately 1,600 m. The area drains towards the north. The unconsolidated material that overlies the solid sediments consists of soil, sand, laterite and clay. The thickness of this unconsolidated overburden averages 6 m, but varies depending on the depth of weathering.

The stratigraphy at Klipspruit is typical of the Witbank Coalfield, refer to Figure 5.4. Exploration boreholes target the full coal-bearing sequence and terminate in Dwyka Tillite. The sedimentary strata comprises mainly white, fine- to coarse-grained sandstone layers with alternating shale and shaly sandstones with bioturbated layers in places. The No.2 and No.4L Seams are separated by sandy shales grading into medium-grained sandstone towards the top. Coarse grained, hard sandstone layers are present immediately above the No.4L Seam.

Coal seams preserved in the Klipspruit area include No.5, No.4U, No.4L, No.3, No.2 and No.1 Seams. As a result of the topographic surface sloping to the north, all of the coal seams except for No.2 and No.1 Seams have been affected by weathering (Figure 5.32). This is especially true of the No.5 Seam, which is almost totally lost to erosion north of the Ogies Dyke.

Figure 5.32: North-south cross-section through Klipspruit

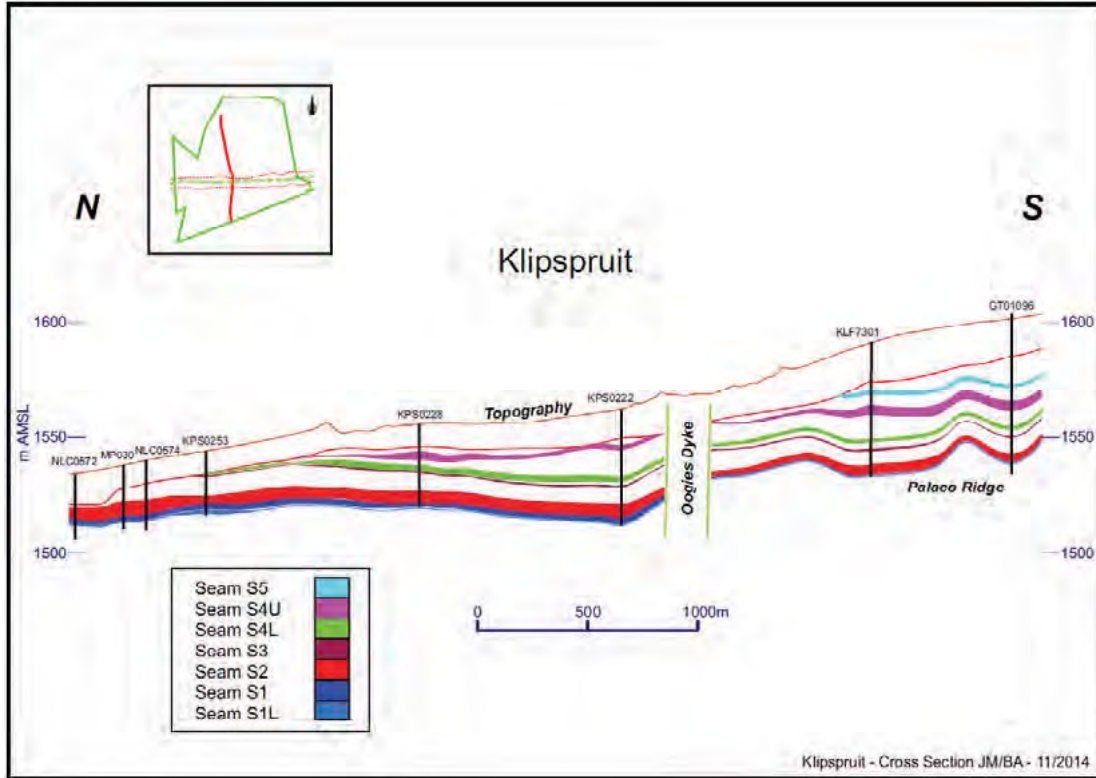

Source: SAEC

A dolerite dyke has been identified in the Bankfontein area, which has affected Coal Resources mainly in the No.4U Seam. This was the result of deep weathering adjacent to the dyke.

The Ogies Dyke is a well-known post-Karoo intrusive structure that extends for some 70 km in an east-west direction. It forms the southern boundary of the main Klipspruit opencast resource area, and separates it from the Klipspruit South resource area. The dyke varies in thickness from 40 m to 70 m and dips steeply to the south. It does not vertically displace the coal seams. The important structural features at Klipspruit are illustrated in Figure 5.32.

5.3.4 Coal Resources

Base data for Coal Resource estimation

Figure 5.33 shows the borehole distribution at Klipspruit available for geological resource modelling and estimation. The plan shows recent and historical drilling, and planned drilling for FY15.

Figure 5.33: Borehole distribution at Klipspruit

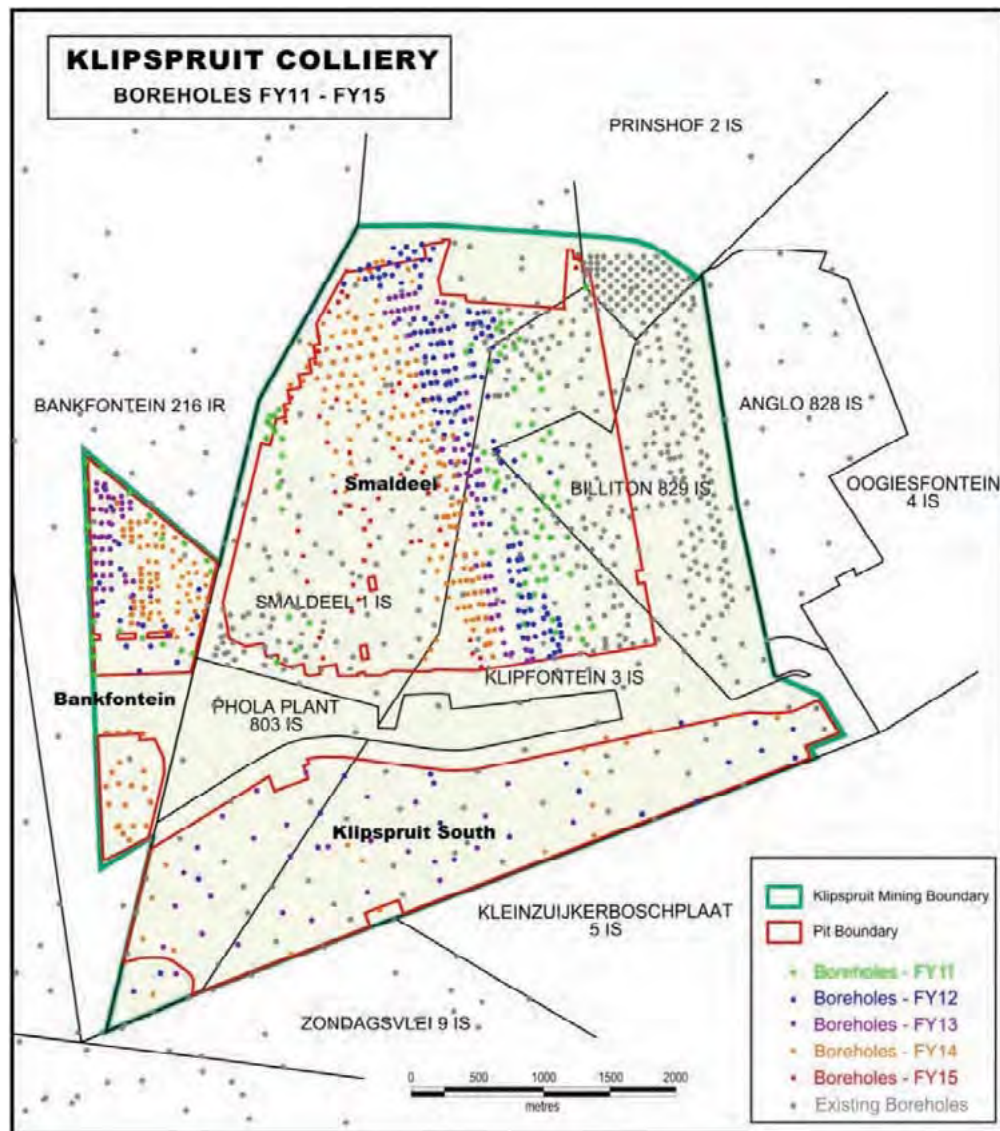

Source: SAEC

Coal Resource statement

Coal Resources are estimated and reported by SAEC in accordance with the JORC Code guidelines and are detailed in Table 5.25. All seams are for SAEC's account.

Coal Resources within the Klipspruit Main Pit and Bankfontein North Pit are reported Inclusive of Coal Reserves.

There are no Coal Reserves associated with the Coal Resources reported for Klipspruit South and Bankfontein South.

Seam thickness cut-off for resource estimation is set at 1 m for opencast resources.

Coal Resource classification is based on washed coal quality points of observation for all seams.

Table 5.25: Klipspruit Coal Resources (adb), as at 30 June 2014 on 100 per cent terms

Resource Class	Seam/Ply	Average Thickness (m)	Tonnes in-situ (Mt)	Ash (%)	Volatiles (%)	Total Sulphur (%)	Calorific Value (kcal/kg)
MAIN PIT							
Measured	No.5	1.69	0.6	20.1	26.3	1.49	5,900
Measured	No.4U	2.98	9.2	38.3	18.8	0.84	4,200
Measured	No.4L	2.25	11	23.9	23.7	1.40	5,590
Measured	No.2	5.11	32	22.7	23.2	1.09	5,660
Measured	No.1	2.15	7.7	30.5	22.3	0.76	5,090
Indicated	-	-	-	-	-	-	-
Inferred	-	-	-	-	-	-	-
BANKFONTEIN NORTH							
Measured	No.4U	2.73	0.4	36.4	18.9	0.74	4,110
Measured	No.4L	2.49	1.0	25.0	22.5	1.01	5,200
Measured	No.2	4.22	3.3	25.1	22.2	1.16	5,370
Indicated	-	-	-	-	-	-	-
Inferred	-	-	-	-	-	-	-
BANKFONTEIN SOUTH							
Measured	No.2	1.88	0.1	22.2	22.0	1.27	5,660
Measured	No.1	2.84	1.3	32.8	19.4	1.01	4,750
Indicated	-	-	-	-	-	-	-
Inferred	-	-	-	-	-	-	-
KLIPSPRUIT SOUTH							
Measured	No.5	1.69	6.9	20.5	27.7	1.99	5,920
Measured	No.4U	3.62	25	37.7	19.9	1.05	4,250
Measured	No.4L	1.41	9.3	23.8	24.4	1.81	5,590
Measured	No.2	4.26	30	24.7	22.6	1.41	5,470
Measured	No.1	1.46	0.4	34.5	20.4	1.60	4,750
Indicated	-	-	-	-	-	-	-
Inferred	No.4U	2.63	0.4	40.4	18.6	0.81	3,940
Inferred	No.4L	1.17	0.2	22.2	24.0	1.76	5,590
Inferred	No.2	1.69	0.5	25.7	22.5	1.40	5,350
Total Measured			138	27.6	22.4	1.23	5,220
Total Indicated			-	-	-	-	-
Total Inferred			1.1	29.8	21.5	1.28	4,950
TOTAL KLIPSPRUIT			139	27.6	22.4	1.23	5,220

Source: SAEC

5.3.5 Coal Reserves

Klipspruit's publicly stated Coal Reserves as at 30 June 2014 are presented in Table 4.9, while the Coal Reserve cut offs are as shown in Table 4.11.

The reported Coal Reserves in June 2013 was 55 Mt of ROM, which was depleted by 9 Mt of ROM production and further reduced by 2.3 Mt due to a reduction in extraction rate from 94 per cent to 88.5 per cent to provide an overall Coal Reserve in June 2014 of 43 Mt ROM.

The current production target of 8.5 Mtpa ROM, reducing to 6 Mtpa over the remaining six years is considered by Xstract to be reasonable, given SAEC has historically achieved similar rates.

The Klipspruit Coal Reserve is constrained by the geological and economic boundaries of the surface operations, which are based on the Mining Rights boundary, geological boundaries defined by Ogies Dyke, burnt coal limits (24 per cent dry ash free volatile ("DAFV")), economic cut-off thickness of 1 m and seams truncated by the line of weathering/oxidation ("LOW").

SAEC has developed a financial model on the estimated production, mining and processing costs and capital expenditure to demonstrate the economic viability of extracting these Coal Reserves.

Reconciliation and modifying factors

For seams within the Klipspruit mining pits, the geological losses applied are around 4 per cent based on historical data. Floor losses for all seams are estimated at 0.1 m and roof losses of 0.1 m. Edge losses of 1 m have been applied to the deeper seams No.3, No.2 and No.1 Seams due to the height of the highwall. Dilution has been estimated at 3 per cent. In Xstract's opinion, these parameters appear reasonable and are considered appropriate for reserve estimation purposes.

Table 5.26: Seam Modifying Factors and Recovery Factors

Klipspruit Mine			Seam					
Mining Area			No.5	No.4U	No.4L	No.3	No.2	No.1
Virgin Coal	Floor Loss	m	0.1	0.1	0.1	0.1	0.1	0.1
	Roof Loss	m	0.1	0.1	0.1	0.1	0.1	0.1
	Edge Loss	m	0	0	0	1	1	1
	Dilution	%	3	3	3	3	3	3

Source: SAEC

The Klipspruit opencast Coal Reserves have been well-defined and are considered to have been appropriately classified in the Proved category.

Table 5.27: Klipspruit Mine Reserves by area

Area	Proved Reserves ROM (Mt)
Main Pit	39
Bankfontein North	4
Total	43

Source: SAEC

Table 5.28: Klipspruit Coal Reserves (adb)

Project	Mining Method	Proved	Probable	Total	Proved Marketable Reserve				Probable Marketable Reserve			
		Mt ROM (adb)	Mt ROM (adb)	Mt ROM (adb)	Mt (adb)	Ash (%)	CV (kcal/ kg)	TS (%)	Mt (adb)	Ash (%)	CV (kcal/ kg)	TS (%)
Klipspruit (June 2014)	Opencast	43	0	43	36	23.0	5,800	0.82	-	-	-	-
Klipspruit (Dec 2014)	Opencast	38	0	38	32	23.0	5,800	0.82	-	-	-	-

Source: SAEC

5.3.6 Mining

Geotechnical/hydrology considerations

A comprehensive Code of Practice covering rock falls and wall instability has been established for Klipspruit. This document outlines a history of previous incidents, as well as future actions to minimise the likelihood of future incidents. History indicates that the incidents of personal injury due to geotechnical failure has been non-existent or very low. There appeared to be some small highwall failures in the soft weathered material, which sloughs into the void. Management were aware and had suitable systems in place to avoid injury or damage.

The design parameters for the mine layout at Klipspruit were based on the coal seam thickness and typical dimensions for a strip open pit mine layout. The topsoil and subsoil are removed and stockpiled separately for rehabilitation purposes. The overburden below the subsoil is highly competent, to the extent that the high wall pit slope is able to be maintained at 90 degrees, with no known pit slope failures.

The mine design is based on 60 m by 100 m mining block sizes.

Mining methods and access

Opencast mining commenced at Klipspruit in 2009, with the No.4L, No.2 and No.1 Seams being the main coal seams mined since that time. The No.4U Seam is separated from the No.4L Seam by a coarse-grained sandstone and mudstone parting. No.4 Seam is of poor inherent quality and is only suitable for the domestic power station market.

The Klipspruit Mine is a single dragline, multi-seam opencast operation (known as Main Pit) combined with a truck shovel mini pit operation (Bankfontein North). The dragline method employed ranges from a single bench to double bench method. Opencast mining uses a series of strips and cuts over a wide area, where the surface is relatively flat and the coal seams comparatively shallow. The stripcut initially started as a boxcut, which was then advanced to a 3 km strip cut with 40 m wide ramps being moved at around 50 m strip cuts and placed as space became available in the low wall.

Coal mining and loading is carried out simultaneously with the overburden removal. As the pit advances, the overburden dumps are rolled back into the pit, to fill the mined out voids, as part of the continuous rehabilitation process. However, Xstract noted during the recent site visit, that the rehabilitation at Klipspruit is well behind plan and considerable work is required to bring this up to date. The majority of the waste is dumped into its final position before rehabilitation by the dragline.

The southern boundary of the main pit hosts Ogies Dyke, a dolerite intrusive body, which has an approximate 100 m offset delineating the pit outline.

The Main Pit has a strike length of approximately 3 km and an average strip ratio of between 2.3 and 3.2 bcm/t ROM over the next six years. The target production from the Main Pit operation is around 7 Mtpa and 1.2 Mtpa from Bankfontein North (Figure 5.34).

The Bankfontein North mini pit is a small truck and shovel operation located to the west of the Main Pit and extends over a 1 km strike length and to a depth of 50 to 70 m. With an average strip ratio of around 2.5 bcm/t ROM, this operation is expected to be completed by April 2016.

The coal seams are mined by 100 t and 130 t trucks and large front end loaders and the coal is hauled between 4 km and 1.5 km depending on the coal operations to a primary

ROM crusher where the crushed coal is conveyed either to the Phola plant (refer Section 5.3.7) for washing or bypassed to a direct “to market” stockpile.

Across the operation, the coal seams are mined separately to ensure quality control. The No.4U and No.1 Seams bypass the Phola washing plant due to the quality of coal in these seams, which cause issues with the coal thickener in the plant to overload. The other seams are crushed and then conveyed to a large ROM stockpile, which is shared 50:50 with Anglo Inyosi. The coal is then lifted by stacker reclaimer and batched washed through the Phola plant to produce an end-product for sale. The bypass produces a 4,800 kcal/kg coal, while the washed coal is either a 4,800 kcal/kg or benchmark export quality coal.

Over the next two to three years, SAEC proposes to excavate and move material currently held in an old mine dump, which overlays a future reserve area. The plan is to re-mine this waste dump by excavator and trucks and move the material approximately 1 to 2 km in order to rehabilitate the Bankfontein mini pit. This will allow the dragline to continue to strip mine in the main pit.

Figure 5.34: Plan showing the current and planned operations

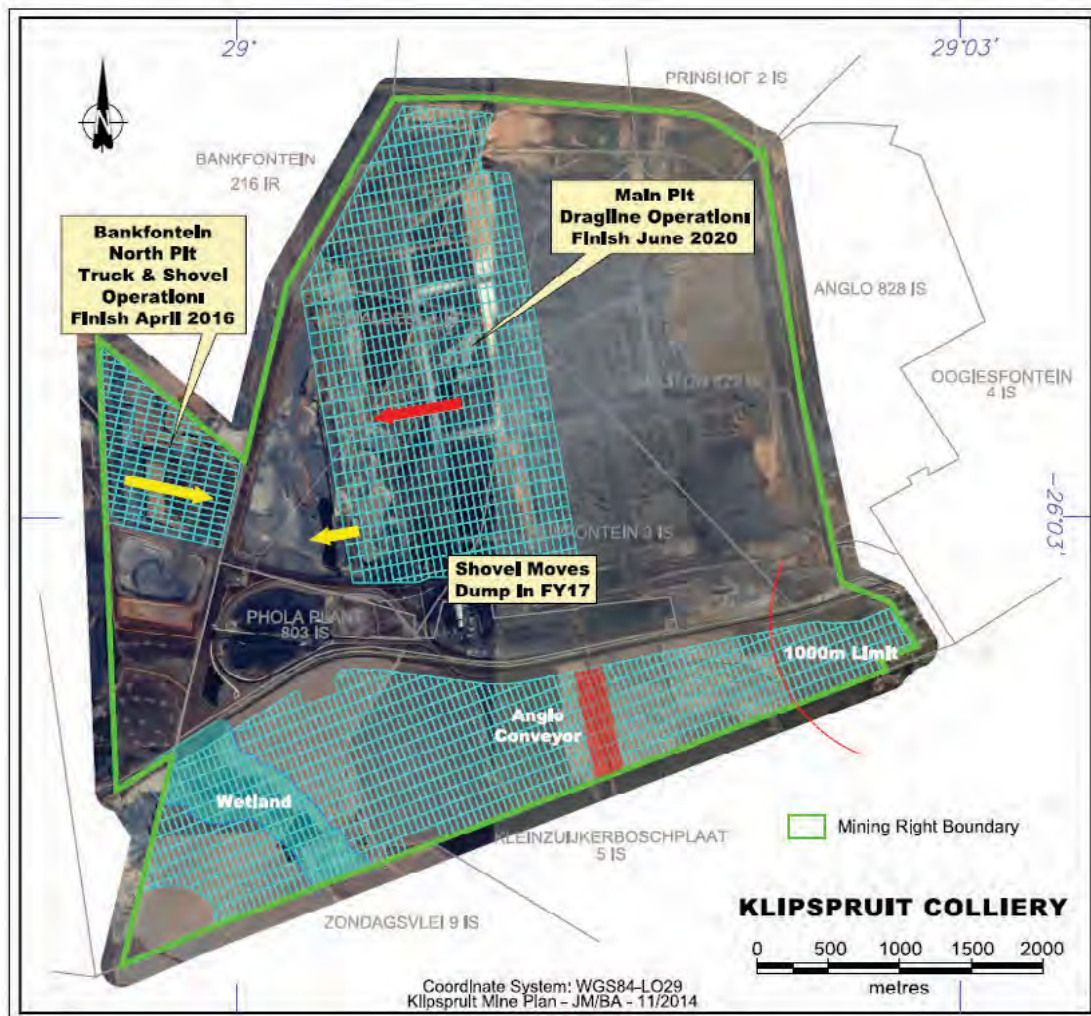

Source: SAEC

Mining fleet

The current open cast mining fleet at Klipspruit is summarised in Table 5.29.

Table 5.29: Major Mining equipment fleet

Machine	Nos of units	Capacity
Dragline Bucyrus 1570-W	1	2390 bcm/hr
Cat 777 haul truck Coal	9	100 t
Cat 993 Front End Loader Coal	3	500 t/hr
Komatsu PC 8000 Hydraulic Shovel	1	1150 bcm/hr
Cat 785 haul truck Coal	2	130 t
Cat 789 haul truck Waste	5	180 t
Cat 777 haul truck Parting	3	100 t
Cat 993 Front End Loader Parting	1	100 t/hr
Cat 740 Articulated Dump Truck – Topsoil	10	43 t
Cat 385 Hydraulic Excavators	2	180 bcm/hr
Pit Viper Overburden drills	3	40 m/hr
ECM – Coal Drills	2	50 m/hr

Source: SAEC Klipspruit_Design_Criteria

Historical operating statistics

The Klipspruit Mine has consistently mined around 8.5 Mtpa of ROM coal for the export market since commencing operations in 2009. Figure 5.35 shows the actual mine production for the last three years compared against the production forecast to FY20. As can be seen, historical figures from Klipspruit are relatively consistent and support production estimates going forward.

Based on current forecast, Klipspruit is expected to be depleted of Coal Reserves in the Main Pit and Bankfontein mini pit in FY20.

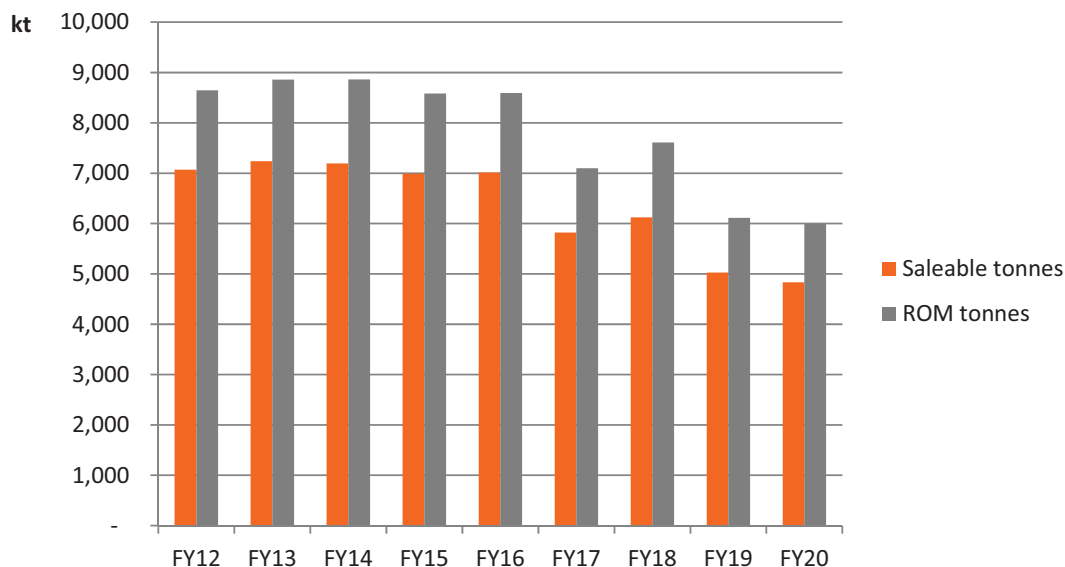
Figure 5.35: Klipspruit - Historical and forecast production

Source: SAEC

Production schedule

The current production forecast for Klipspruit is summarised in Table 5.30.

Table 5.30: Klipspruit Production Schedule FY15 to FY20

Description	Units	FY15	FY16	FY17	FY18	FY19	FY20
Topsoil Stripped	kbcm	1,308	1,280	1,274	491	298	164
Area disturbed	ha	82	84	83	33	-	-
Area rehabilitation	ha	90	91	89	99	98	90
Pre-strip	kbcm	-	-	2,534	2,175	-	-
Dragline In-situ	kbcm	13,251	14,745	12,871	14,297	14,056	13,812
Dragline Rehandle	kctm	2,988	3,177	2,364	2,356	2,212	1,924
Shovels	kbcm	6,817	6,281	5,080	-	-	-
Parting	kbcm	345	339	233	327	463	-
Total In-situ Waste	kctm	21,721	22,645	21,992	17,290	14,817	13,975
Total Waste	kctm	24,710	25,883	24,357	19,646	17,030	15,901
RoM	kt	8,582	8,593	7,098	7,608	6,114	5,994
Strip Ratio	bcm/t	2.53	2.64	3.20	2.44	2.42	2.33
Benchmark Product	kt	3,480	3,540	2,944	2,788	2,620	2,338
4,800 Product	kt	3,510	3,475	2,877	3,334	2,404	2,494
Total saleable	kt	6,991	7,015	5,821	6,123	5,024	4,833

Source SAEC Klipspruit Reserves_20141021

Klipspruit's forecast production breakdown, based on SAEC's current LOA plan is presented in Figure 5.36.

Figure 5.36: Klipspruit Production Breakdown

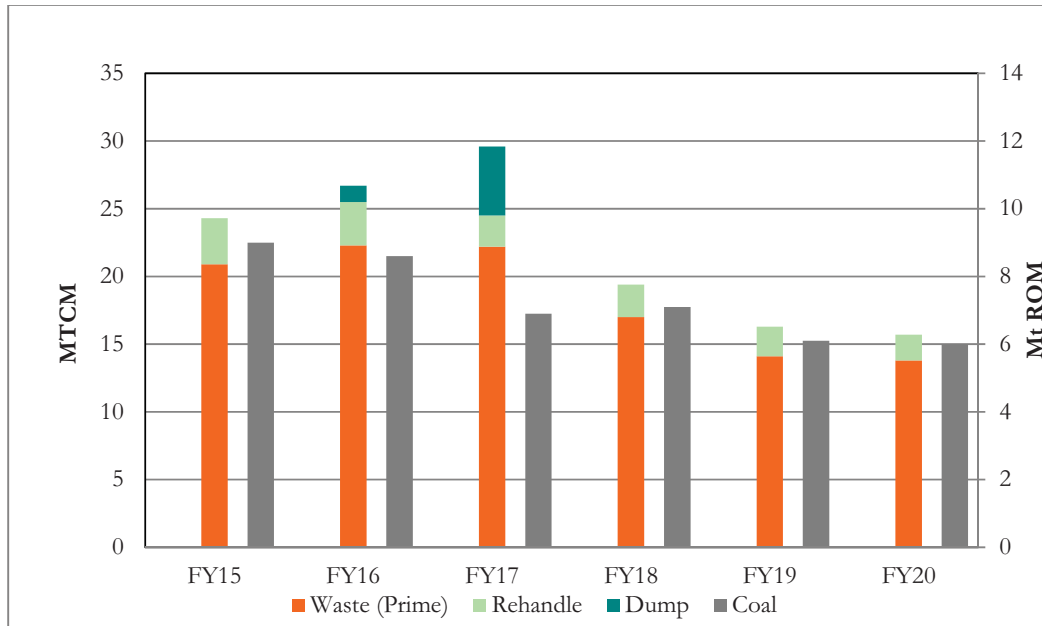

Source: SAEC Klipspruit Reserves_20141021

Xstract considers SAEC’s planned production schedule is reasonable and achievable given that Klipspruit has previously produced at higher rates than are currently being forecast going forward. The current mine plan for Klipspruit includes a reduction in capacity as the mine’s Coal Reserves are depleted and the pit shell reduces in size. This is independent of the Klipspruit Extension Project.

5.3.7 Coal processing

The Phola Coal Handling and Preparation Plant (“CHPP”) operates as a 50:50 feed to plant joint venture between SAEC and Anglo Inyosi. The joint venture has a 20-year contract term, which commenced in 2009.

The CHPP is designed to wash 16 Mtpa with each shareholder entitled to 8 Mtpa of coal throughput. Coal is washed in campaigns with each shareholder typically allocated three days per week of coal processing time. The seventh day of the week is allocated for maintenance (between 12 and 18 hours).

Other maintenance time is allocated around the Christmas/New Year period when mine production slows.

Coal quality

SAEC produces targets two main saleable products at Phola for export markets, through a combination of raw coal bypass, coal washing (primary and secondary circuits) and final blending:

1. 4,800 kcal/kg Export
2. Benchmark product

Export tonnages are dictated by supply contracts and rail and port allocations with TFR and RBCT respectively.

General ROM coal allocation assumptions for Phola have been described by SAEC as follows:

- No.2 and No.4L Seams are processed in the Phola CHPP to produce an export quality Benchmark product.
- No.1 and No.4U Seams bypass the Phola CHPP to produce the 4,800 kcal/kg product for the export market.

Processing method

Coal crushing, stockpiling/blending and processing technology utilised across BCP's operations is standard technology that has been used in operating coal plants worldwide for over 75 years.

Before entering each processing facility ROM/Raw coal enters a three-stage crushing system to reduce particle topsize to -50 mm.

The general allocation assumptions are listed in the section above.

Phola has a blending stockpile before it from which coal is reclaimed as plant feed.

The Phola plant is designed to process 16 Mtpa of coal in two modules (1180 tph each) with approximately 6,800 operating hours per annum or an average 570 operating hours per month. Under its joint venture with Anglo Coal SAEC is allocated 8 Mtpa of coal processing capacity at Phola.

Each module has two low-density Dense Medium Cyclone (DMC) circuits producing a primary export product:

- The first processing coal in the -50 mm + 8 mm size fraction
- The second processing coal in the -8 mm + 0.6 mm size fraction.

Each module then has a single high-density DMC circuit taking discard from the low-density circuits (-50 mm + 0.6 mm) and producing a middlings product.

Deslimed fine coal (-0.6 mm + 0.2 mm) is processed in conventional spirals circuits. The clean coal is then dried and reports to either the primary or middlings export products.

Coarse and fine rejects are combined and transported via conveyor to the discard bin ready for disposal.

Coal slimes are treated differently at each of the SAEC export plants. At Phola there are no tailings dams. As a result slimes (-0.2 mm) are thickened and dried in pressure filters. The filtered slimes can then report to the plant discard (for dry disposal in the mine with the other plant discards) or to the middlings product.

Figure 5.37 provides a block flow diagram for the Phola CHPP.

Figure 5.37: Phola CHPP Block Flow Diagram

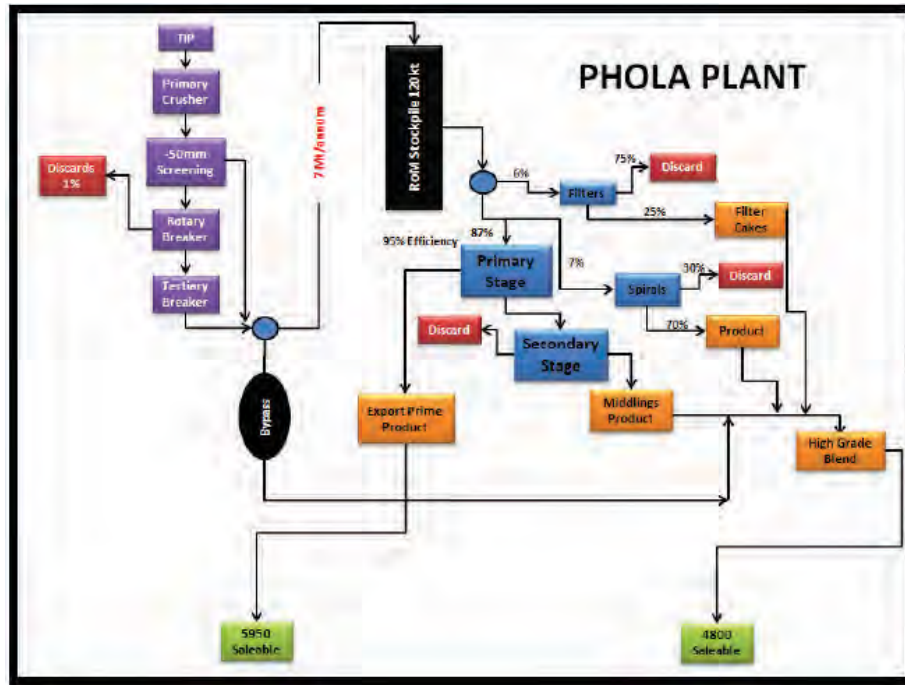

Source: Phola Presentation – Phola Plant Overview 20141021

The Phola CPP has been designed for an average primary yield of 45 per cent (with a minimum yield of 32 per cent and a maximum yield of 63 per cent) and an average secondary (middlings) yield of 30 per cent (with a minimum yield of 15 per cent and a maximum yield of 43 per cent).

Historical and forecast operating statistics

Production statistics provided by Phola are listed in Table 5.31.

Table 5.31: Phola SAEC Production Statistics

Item	Design Capacity	Actual FY12	Actual FY13	Actual FY14
SAEC Utilisation of Total Available hours	50%	59%	54%	53%
Total Operating Hours per Annum	6,800	5,661	5,821	5,757
SAEC Feed kt per Annum	8,000	7,497	7,059	6,948
Variance on SAEC Design Feed kt per Annum	NA	(503)	(941)	(1,052)

Source: Phola Spreadsheet – 8 Monthly Performance

Table 5.31 shows that since FY12 SAEC's utilisation of available CPP hours has been reducing to meet its 50 per cent entitlement (both SAEC and Anglo Coal are entitled to 50 per cent of the available CPP operating hours, however Anglo Coal has not been utilising theirs).

At the same time total operating CPP operating hours per annum have also been decreasing.

This shows there is potential production upside in the Phola CHPP for SAEC to exploit through an increase in available running hours. However, this potential needs to be confirmed with a detailed review of past downtime, future mine production, coal allocation, and the effect of future coal quality on capacity (e.g. from KPSX).

CHPP infrastructure

During discussions with operations personnel no particular issues were mentioned in relation to CHPP infrastructure.

No details were provided of plant downtime to determine whether, like BCP, power interruptions are responsible for the lower operating hours.

The CHPP dry disposes of tailings so water is rarely problematic. Mine water is mainly used as a water make-up supply. An emergency supply does exist but was described as not having being used.

Tailings and waste management

The Phola CHPP allows for dry waste disposal only. CHPP discards are drawn from two sources:

- Rotary breaker discards
- Coarse Rejects and dried tailings.

Depending on its quality, dried tailings can be directed to discards or blended with product coal.

SAEC hauls and disposes all discards produced by the CHPP within the mined out opencast workings at the Klipspruit Mine (including those produced through the washing of JV partner coal for which it receives an income stream).

The future discards haulage arrangement needs to be considered in the future along with the impacts this arrangement will have on future mining operations at Weltevreden (Klipspruit Extension).

5.3.8 Equipment and manning

Current manning levels for the Klipspruit Mine are presented in Figure 5.38.

Figure 5.38: Klipspruit - Employee numbers

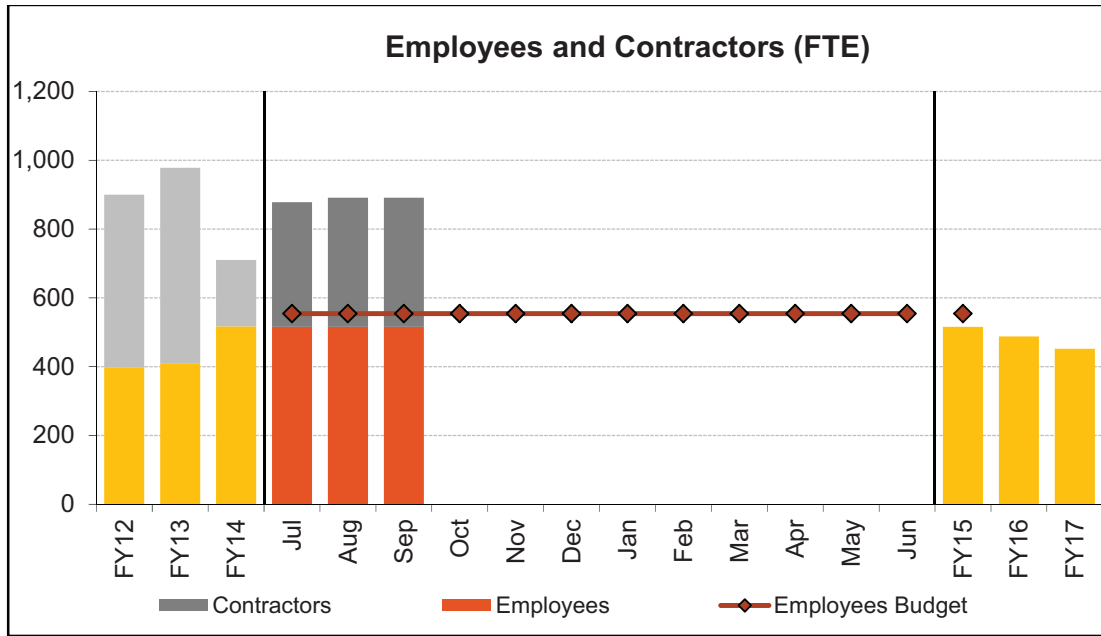

Source: SAEC

Phola CHPP

The Phola joint owner’s team consists of seven personnel. The remainder of the work-force comprises contractors.

Phola CHPP operations and maintenance are contracted to Minopex (a subsidiary of the plant designer DRA) who were recently awarded a five-year contract extension. As of October 2014, Minopex employed 186 full time staff on the Phola CHPP.

Phola has an on-site laboratory. Coal laboratory services are contracted to Coallab who have 30 personnel (October 2014). The laboratory is not yet accredited. The operator has been notified that it has one year to achieve the required accreditation.

As theft (particularly copper theft) is an ongoing issue in South African mines, Phola has a security contract with Bidvest Magnum employing 46 personnel (October 2014).

5.3.9 Management and Industrial Relations

Throughout this assignment, Xstract representatives have been in regular contact and held numerous discussions with all levels of SAEC’s technical and management teams. Based on this contact, Xstract is satisfied that SAEC has established a capable management team at Klipspruit and that the coal mine management understands the key drivers and risks at the mine and have developed credible systems and operational plans to manage the mine effectively. SAEC has established a technical services group, which coordinates LOA mine planning and comprises of geological, mining engineering and environmental management.

5.3.10 Health and Safety

SAEC has an executive safety committee, which sets health and safety management policy across the operations. Direct health and safety responsibility rests with the line management and, as is essential in the effectiveness of any system, relies on workforce involvement.

Safety performance (as expressed in All Injury Frequency Rate) at Klipspruit over the last three years has reduced with the numbers of lost time rate remaining on average relatively low to the other sites within SAEC.

Figure 5.39: Klipspruit safety performance

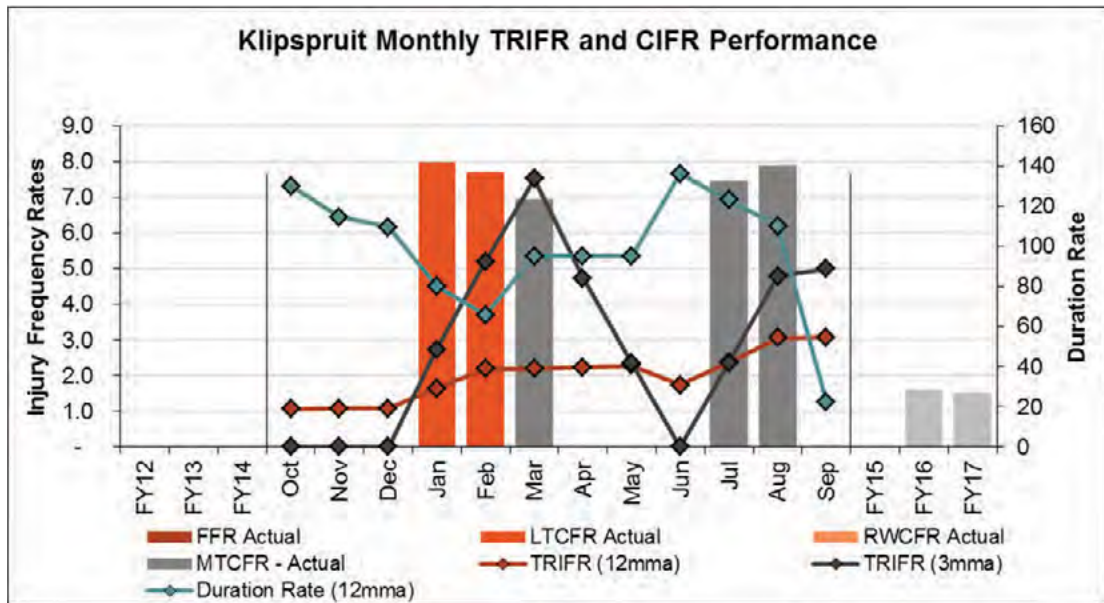

5.3.11 Infrastructure and transportation

Water

Klipspruit Mine receives water from the Phola plant, which supplies potable water to the mine at an average of 2 Ml/month. Additionally, process water is sourced from pollution control dams, which have a combined volume of 600 Ml. A potable water supply contract is in place with Eskom.

Power

Klipspruit Mine has a dedicated power supply to support mining operations with 3,500 MWh per month, 6.6 MVA maximum demand usage and 7 MVA notified maximum demand. SAEC's LoA plan suggests that the power required to carry out mining operations can be met by the current system.

Rail

A major focus of the SAEC FY15 five-year plan is the train system and ensuring minimal train cancellations initiated by SAEC. A key part of this plan is to improve internal logistical coal flow by:

- Identify minimum and target export stock levels
- Remove internal transportation bottlenecks
- Take advantage of internal available transportation capacity (i.e. internal rail)
- Increase live export stockpile capacity.

Phola has the following product storage capacity per JV partner:

- 120,000 t live reclaim

- 400,000 t for emergency push-out.

The largest capital project on site since commissioning in 2009 has been the expansion of the product stockpiles due to the inconsistent nature of train arrivals and the resultant requirement to be able to hold greater stocks.

Phola has two train load-out systems and can load two trains concurrently. FTR trains carry just over 8,400 t per train and the loadout systems can load them in two hours. The train load-out silos carry 8,400 t.

In its review of rail constraints, SAEC has recommended that coal stocks fall no lower than a minimum 90,000 t and that a target stock level of 170,000 t be maintained.

Additionally SAEC has recommended that feeder breakers be installed on the emergency push out to increase live capacity and guard against loss of reclaimers.

These feeder breakers are now on site awaiting installation.

5.3.12 Marketing

Domestic

SAEC supplies mainly No.5 Seam coal to local traders on a negotiated basis, with terms of these sales ranging from ad-hoc to more than 12 months. Pricing for supply depends on quality (including CV, Ash, Volatile level and sizing) and application.

Export

SAEC has off-take agreements with four existing customers for the export of its high-grade Benchmark product and a middlings (4,800 kcal/kg) product from the Klipspruit Mine. These products are exported via RBCT.

5.3.13 Environment and social

Environmental and social status

The primary environmental impacts at Klipspruit include groundwater, the impact of mining on water courses and wetlands, air quality, noise and blasting.

There are two settlements in proximity to Klipspruit. The small town of Ogies is approximately 1 km east and Phola 2 km north of the mine. Phola is the nearest significant community and a percentage of Klipspruit's labour force is sourced from Phola.

Phola is a low income, informal settlement, with a history of resistance to mining. There is a risk that the Phola community may object to any future development. SAEC is successfully engaging with the local community via various community programmes.

Permitting requirements

Performance assessments are conducted every second year by independent consultants against the approved EMPr and WUL. These performance assessments have been accepted by the DMR and the mine is legally compliant with regards to its submission.

Potential impacts, control measures and environmental management

Rehabilitation

Rehabilitation of the opencast pit is behind current plans and the rehabilitation efforts at Klipspruit can be accelerated. SAEC has a rehabilitation and closure plan, which aims to address these shortfalls in time. In Xstract’s opinion, the rehabilitation excess increases the water make of the mine and it is in the mine’s best interest to expedite rehabilitation.

For Klipspruit, the total area disturbed for FY14 is just over 1,000 ha. Going forward, this disturbed area is forecast to increase between 2014 and 2018. There is a commitment to rehabilitate land from FY15 at the rate of 120 ha per annum, 2016 at approximately 100 ha per annum, before falling to 90 ha and 80 ha in FY17 and FY18. The surface rehabilitation planned continues after the mining ceases in 2019 and large-scale rehabilitation is only planned for the period, FY22 to FY27.

The planned rehabilitation only occurs well after disturbance as evident in Figure 5.40, whereas rehabilitation is typically concurrent with mining. The annual expenditure for rehabilitation at Klipspruit Mine is presented in Figure 5.41.

Figure 5.40: Total area disturbed and Land Rehabilitated vs Land Disturbed at Klipspruit

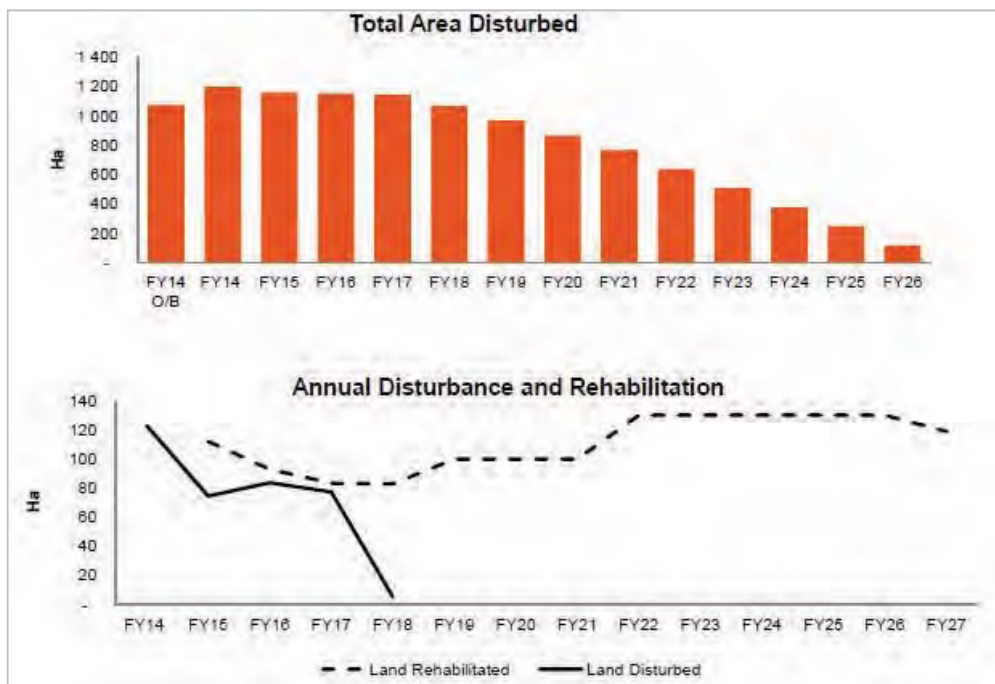

Source: SAEC 2013

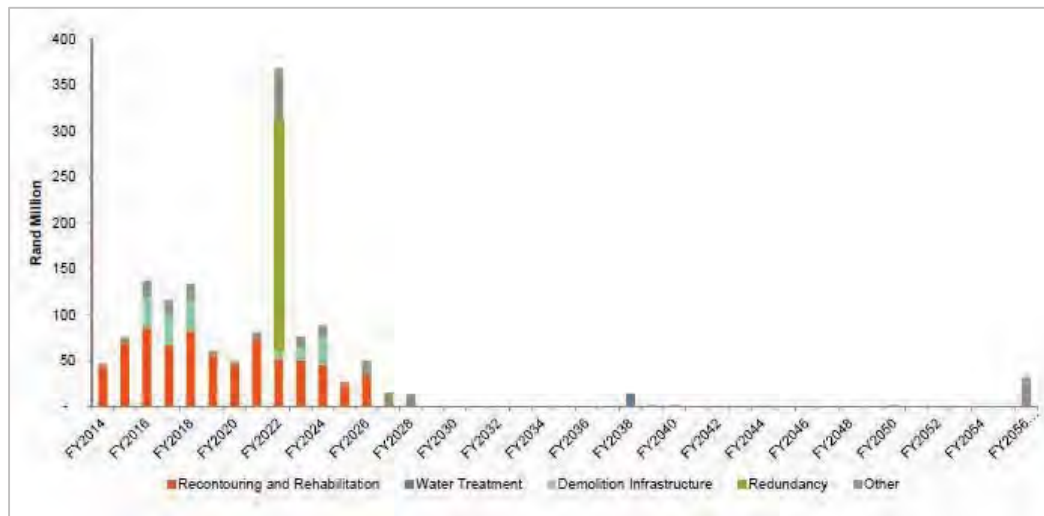
Figure 5.41: Proposed expenditure on rehabilitation at Klipspruit (ZAR M per annum)

Source: SAEC 2013

Coal discards and water issues

Currently, discards from Klipspruit Mine and Phola processing plant, as well as Anglo Inyosi's Zibulo Colliery, are disposed in the mine void. Under the approved EMP and WUL, SAEC has permission to dispose of discards up to the water table or a level of 1,518 m amsl, with the proviso that should groundwater qualities be affected, steps must be put in place to rectify this. This leaves SAEC responsible for any current and potential future AMD issues. Current discard disposal is occurring above the approved level and SAEC is currently pursuing appropriate environmental authorisations for this activity.

A coal discard facility will be required in the future to account for discards originating from the proposed KPSX until the end of life of the Phola Plant (FY41). The future coal discard facility will require appropriate environmental approvals as part of its license to operate.

The main pit is located at the headwaters of the several small drainages and thus any AMD may contaminate existing watercourses. SAEC management are aware of the issue and are currently investigating options to ameliorate any potential AMD contamination.

Currently all water make in the Klipspruit pits (mainly Pit 1), which is approximately 4 Ml/day, is being used in the Phola plant. There is thus no decant occurring from the mining areas and there will be no decant as long as the Phola plant continues to use this amount of water.

The use of trees to reduce water make from a mining area is logical and should be supported, but it is likely that there will have to be some long-term active water treatment other than just forestry implemented at this site. Xstract recommends that capital be allocated for active treatment of water should the current planned passive system prove to be insufficient.

Closure planning

Klipspruit Mine is expected to close in FY20 should the KPSX and Klipspruit South Projects not proceed. SAEC's 2013 Closure Plan assesses a Deterministic Closure Liability quantum for Klipspruit as at 30 June 2013 amounting to ZAR682 M. The closure liability provides for demolition of infrastructure, water treatment, removal of roads and railway lines, etc. The

Phola Coal plant JV requires a provision of ZAR16 M, in addition to that at the mine. These quantum are in line with expectation for an operation of this size.

Upon closure, there is a commitment that water will be treated to potable standards and that acid water will not contaminate any other water body.

In the closure plan, the discard dump or stack is expected to be 110 ha in area and will be rehabilitated to the relevant standards.

Should the KPSX and Klipspruit South Projects not be pursued, a closure plan for Klipspruit will be finalised and presented to the DMR in FY15.

5.3.14 Cost assumptions

Operating costs

Mine costs

Xstract compared projected costs against historic mining costs provided by SAEC and within Xstract's internal database. The estimated real average waste removal cost is ZAR23.38/bcm over the life of the Reserves (Table 5.32). Xstract considers this cost to be appropriate given Klipspruit's requirement to move additional dump material to access coal resulting in a higher waste removal cost than at WMC (estimated at ZAR2.93/bcm higher).

Excluding the Phola take or pay ("ToP") commitments, Xstract estimates the coal mining average real cost at ZAR63.00/t Prod.

Table 5.32: Klipspruit real average mining cost

Item	Unit	Actual FY12	Actual FY13	Actual FY14	Long term	Unit	Long term
Waste Removal	ZAR/bcm	25.43	27.48	23.11	23.38	USD/bcm	2.07
Mining	ZAR/t Prod	80.88	79.68	70.91	63.00*	USD/t Prod	5.59*

Source: SAEC, Xstract estimate

Note: * excludes Phola ToP commitment

Table 5.33: Forecast mining costs (real)

Item	Unit	FY15 2 nd H	FY16	FY17	FY18	FY19	FY20
Waste Removal	ZAR/bcm	24.49	22.37	22.62	25.63	23.59	22.07
Mining*	ZAR/t Prod	57.34	63.41	65.56	69.03	62.34	59.18

Source: SAEC, Xstract estimate

Note: * excludes Phola ToP commitment

Processing costs

The wash plant has an average overall yield for the life of the operation at 83 per cent, which is better than the 74 per cent achieved at WMC. As a result, Klipspruit's real average life of mine processing cost is estimated at ZAR37.04/Prod t (USD3.29/Prod t) compared to ZAR61.26/Prod t (USD5.44/Prod t) at WMC. Xstract considers this processing cost to be appropriate for the Klipspruit operation.

SAEC has allocated a cost of USD119 M over 10 years, which is related to Phola take or pay (ToP) commitment and occurs once the mine has finished production in 2020.

Port and transportation costs

As with WMC, the rail contract for export tonnes from mine to Richards Bay coal terminal is a fixed ZAR/t rate that is escalated annually. This also applies to the port handling costs at Richards Bay. Xstract has assumed that any unutilised spare rail and port capacity will be sold to a third party not affecting the value of the Reserve as a penalty.

Total cash costs

Figure 5.42 illustrates the real cash costs of the scheduled Reserves over the life of the Reserves. Operating costs are expected to decline from approximately USD260 M (real) per annum to USD190 M at the end of reserve life in 2020. Rail and total mining costs each account for 29 per cent of total operating costs. While the next largest is administration and overhead costs at 20 per cent that include both site overheads and SAEC corporate costs.

Figure 5.42: Klipspruit cash costs (real)

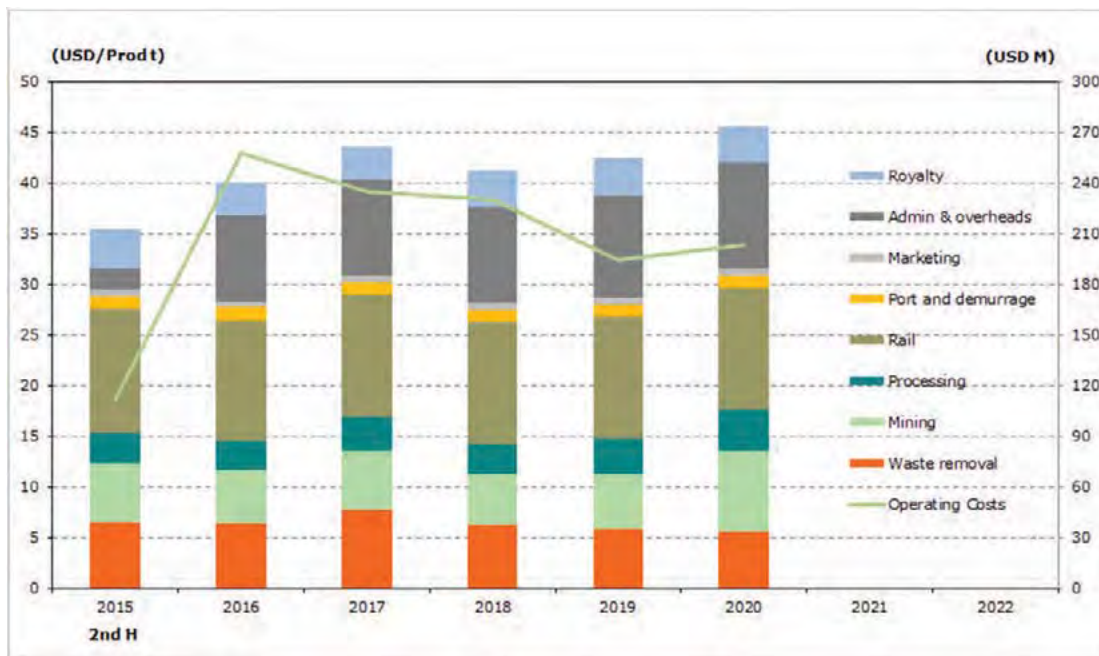

Source: SAEC, Xstract estimates

5.3.15 Capital expenditure

Sustaining capital expenditure is estimated by SAEC at USD17 M (real) comprising refurbishment of plant and mining equipment and USD1 M on closure. This includes expenditure on dragline overhauls, refurbishment of earth moving and ancillary equipment as well as for the CHPP. Xstract considers this estimate to be reasonable.

Table 5.34: Klipspruit Capital Expenditure and closure cost (real)

Item (USD M)	FY15 2 nd Half	FY16	FY17	FY18	FY19	FY20- beyond
Sustaining	3.0	7.9	5.8	-	-	-
Closure	-	-	-	-	-	1.3

Source: SAEC, Xstract estimates

5.3.16 Closure costs

Closure costs were allocated to the operating costs as rehabilitation concurrent to mining and extend beyond the mine life. An estimate for redundancies is made in the final year. Salvage value of plant is not considered material.

5.3.17 Risk and opportunities

Risk

Tenure

The Klipspruit Mining Right currently specifies the Klipspruit South area as an underground mining area. However, due to current economics, it is now more viable to mine Klipspruit South using opencast methods.

SAEC intends to amend its existing Mining Work Program for Klipspruit according to Section 102 of the MPRDA to mine the Klipspruit South area using opencast strip mining methods. There is a risk that the DMR do not approve the conversion from an underground mining right to an open cast operation.

Geology

In general, seams are thinner, yields are lower and strip ratios are higher in the Weltevreden Coal Resource area, which is proposed as a replacement for Klipspruit Mine.

The potential impact of wetlands and drainages on current mine plans at Weltevreden Coal Resource area requires further investigation.

Mining

There are currently few major mining physical risks associated with Klipspruit apart from the ongoing normal risks associated with mining relating to underperformance and not achieving current forecast production. SAEC forecast plans are based on historically achieved production rates.

Processing

Risks to Phola operations have been identified in the Phola CHPP operations and have been addressed by the joint venture partners since commissioning of the facility in mid-2009.

For example, risks associated with TFR train delays and becoming stockpile bound have been mitigated with the expansion of the product stockpiles and acquisition of additional reclaim capacity through feeder breakers should issues of availability occur with the existing product reclaimer system.

Phola has also progressively addressed issues associated with equipment availability in the CHPP.

One risk that requires attention is the impact on CHPP reject capacity and the subsequent impacts on rejects haulage resulting from the processing of lower quality coal from the future KPSX.

Environment

Risks at Klipspruit include the rehabilitation backlog, which will need to be addressed and expedited in order to avoid unplanned operational costs. A formal closure application and closure plan may be required in FY15, should the expansion projects not proceed. The successful rehabilitation of the opencast pits and strict water control measures will prevent acid water entering existing water courses. Without these measures, the potential for AMD is significant.

Opportunities

Opportunities for the Klipspruit Mine are outlined below.

Geology

An opportunity exists to reduce the minimum thickness cut-off of coal seams. This would however also require appropriate equipment to efficiently mine the reduced thickness.

Mining

There are some small opportunities to improve productivity. However, as production ramps down to closure due to decreasing capacity there will be opportunities to cost savings through the reduction of the use of contractors.

Processing

Currently, SAEC is installing a dry screen facility to improve ROM bypass to increase yield.

Growth

Previous studies have demonstrated the presence of viable coal seams within the Klipspruit South area (i.e. south of R555 provincial road). These seams are currently being evaluated by SAEC for a potential brownfields opencast development. The Klipspruit South area is discussed further in Section 5.3.18.

The Klipspruit South area lies immediately to the south of the current Klipspruit Mine workings and is considered prospective for the development of an open pit to the south of the Ogies Dyke. Pre-feasibility study level evaluation of this option remains on-going.

To the northeast of the current workings, SAEC holds the Weltevreden Prospecting Rights, which cover an area totalling 7,327 hectares. The Weltevreden Coal Resource area represents a potential greenfields expansion to the Klipspruit Mining Right encompassing an opencast mining operation targeting all five coal seams. The Weltevreden Coal Resource area is currently being evaluated by SAEC under the Klipspruit Extension Project ("KPSX") as discussed in Section 6.2 of this report.

To this end, SAEC has applied for an amendment to extend the Mining Right and the Mining Work Programme for the Klipspruit Mine under the terms of the provisions of Section 102

of the MPRDA to incorporate the Weltevreden Coal Resource area, which it proposes to mine using opencast strip mining methods.

5.4 Khutala

Khutala is an underground and opencast coal mining operation situated at latitude 26°7'22" South and longitude 29°0'15" East, in the Ogies area of Nkangala District Municipality in of Mpumalanga Province. The operation is wholly owned and operated by SAEC, with underground production from the No.2 and No.4 Seams tied to Eskom's Kendal Power Station, which lies immediately to the northwest of the mine area. The No.5 Seam is developed by open cast and is trucked to Klipspruit and blended.

The closest town to Khutala is Ogies, while Witbank is some 55 km to the northeast. The mine is accessible from the R545 and other minor provincial roads. The Richards Bay Rail Line is located immediately north of the mine area on SAEC's adjacent Klipspruit Mining Right.

5.4.1 Land tenure

Ownership, status and agreements

The farm properties and mineral rights, which comprise the Khutala Mine and its related legal tenure are summarised in Figure 5.43, Table 4.3 and Appendix B. The mineral and surface access rights are sufficient for all aspects of the mining and processing operation.

Figure 5.43: Mining areas and associated wetland areas within the Khutala Mine

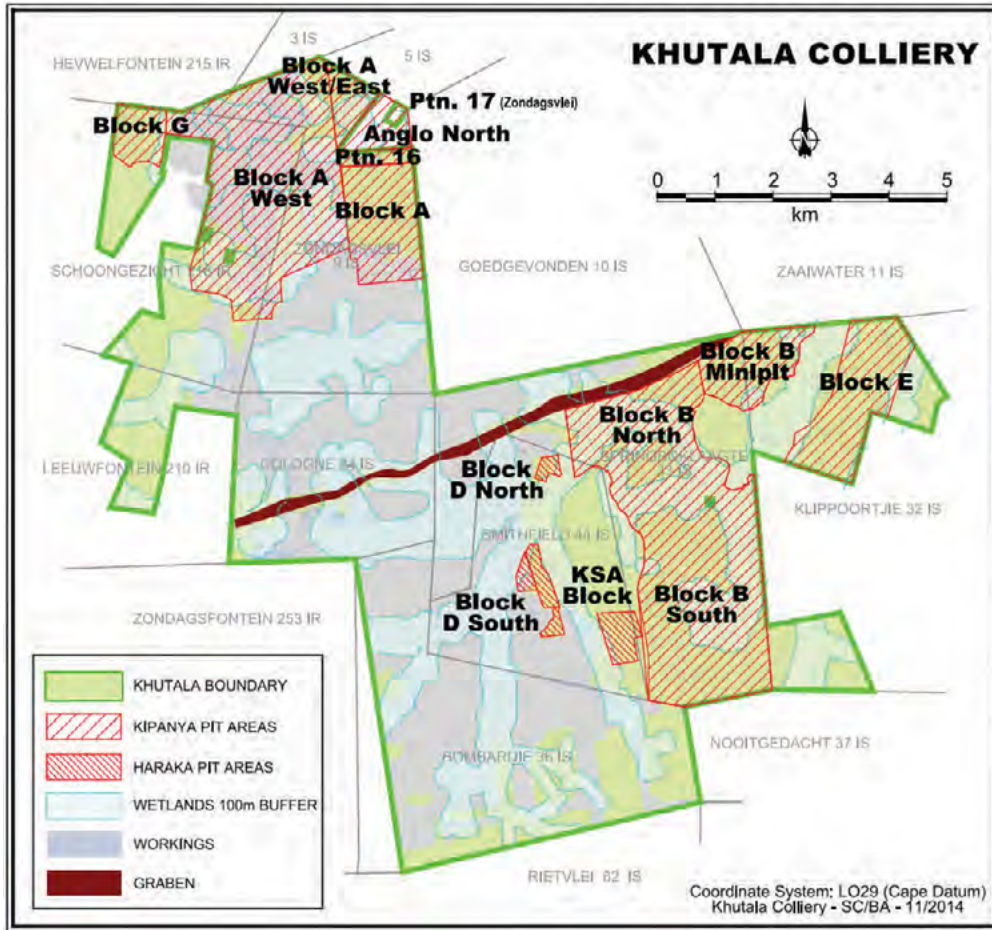

Source: SAEC

Material contracts

Under an agreement with Eskom, SAEC is contracted to supply the Kendal Power Station with a stipulated coal tonnage each month to be sourced from the No.2 and No.4 Seams at Khutala until 2033. The terms of the Khutala contract remain confidential but it involves a cost plus arrangement based on a formula that includes a return on invested capital and inflation price escalation. Xstract has discussed this contract with SAEC representatives and considers that the commercial terms are appropriately reflected in SAEC’s long-term plans.

SAEC has also an outbye (i.e., away from the coal-face) service agreement for provision of maintenance, bolting, ventilation, etc. at Khutala.

The mine currently has a grazing contract with a local farmer for grazing and baling.

Other legal issues

Eskom has lodged a claim against SAEC for “failure to supply its contracted coal tonnages”. The claim has been referred to arbitration for determination and is opposed by SAEC. This is likely to have an impact on production moving forward.

Detailed assessment of this claim is outside of the scope of this report. Xstract understands full details of this claim were considered in the legal review undertaken by BHP Billiton and were not included in the Listing Documents on materiality.

5.4.2 History

Ownership

Khutala is wholly owned and operated by SAEC.

Until 1994, Khutala was owned by Randcoal. It then passed to ICC (and then to Ingwe), as a result of the merger between Randcoal and Trans-Natal Coal Corporation. In 1997, ICC became part of Billiton, which then merged with BHP Limited to become BHP Billiton in 2001.

Project development

The Khutala mine area and the former Kendal Mine (now part of Block A West) have been worked intermittently since the 1940s, with production largely derived from underground and limited opencast mining of the shallowest seam, No.5 Seam. Key production periods were from 1940 to 1965, 1996 to 2004 and 2003 to present.

In September 1981, the tender for the supply of coal to the Kendal Power Station was first approved and subsequently awarded to ICC. The Khutala mine was commissioned as a single product mine in order to supply coal to Kendal on a cost-plus basis. Site preparation for the mine commenced in 1984.

Initially, underground mining commenced as a relatively deep bord-and-pillar operation extracting coal from the No.2 and No.4 Seams, with first coal sent to Kendal in November 1986.

Small opencast operations targeting No.2 and No.4 Seams commenced in 1996. In 2003, mining of the No.5 Seam commenced in order to produce thermal and metallurgical coal products for the domestic market. Since then, four small opencast sections have also been completed and rehabilitated. A fifth opencast pit is underway.

Recent production history from Khutala is discussed in Section 5.4.6.

5.4.3 Local geology

The primary geology and stratigraphy at Khutala is typical of the Witbank Coalfield, refer to Figure 5.4. The development of the No.2 and No.4U Seams occurred mainly in a broad valley of low topographic relief where coal seams terminated towards the east and west of the property. This thinning or absence of coal seams towards the east and west is due to a gentle rising of the pre-Karoo relief. Coal Resources in the No.2 and No.4U Seams within the Khutala mining right area is contracted to Eskom and mined coal is delivered raw to Kendal Power Station.

The No.1 and No.2A Seams are either absent or only locally developed with restricted extents across the area due to elevation differences in the palaeo-floor which consists of either basement felsite or Dwyka Formation.

Two prominent hilltops within the Khutala boundary represent major felsite palaeo-high ridges that truncated the coal measures during deposition. These no-coal areas are shown in Figure 5.44 and their effect on coal seams is illustrated in Figure 5.45. Seam dips can reach 15° on the flanks of palaeo-highs.

Figure 5.44: Main geological structure features at Khutala

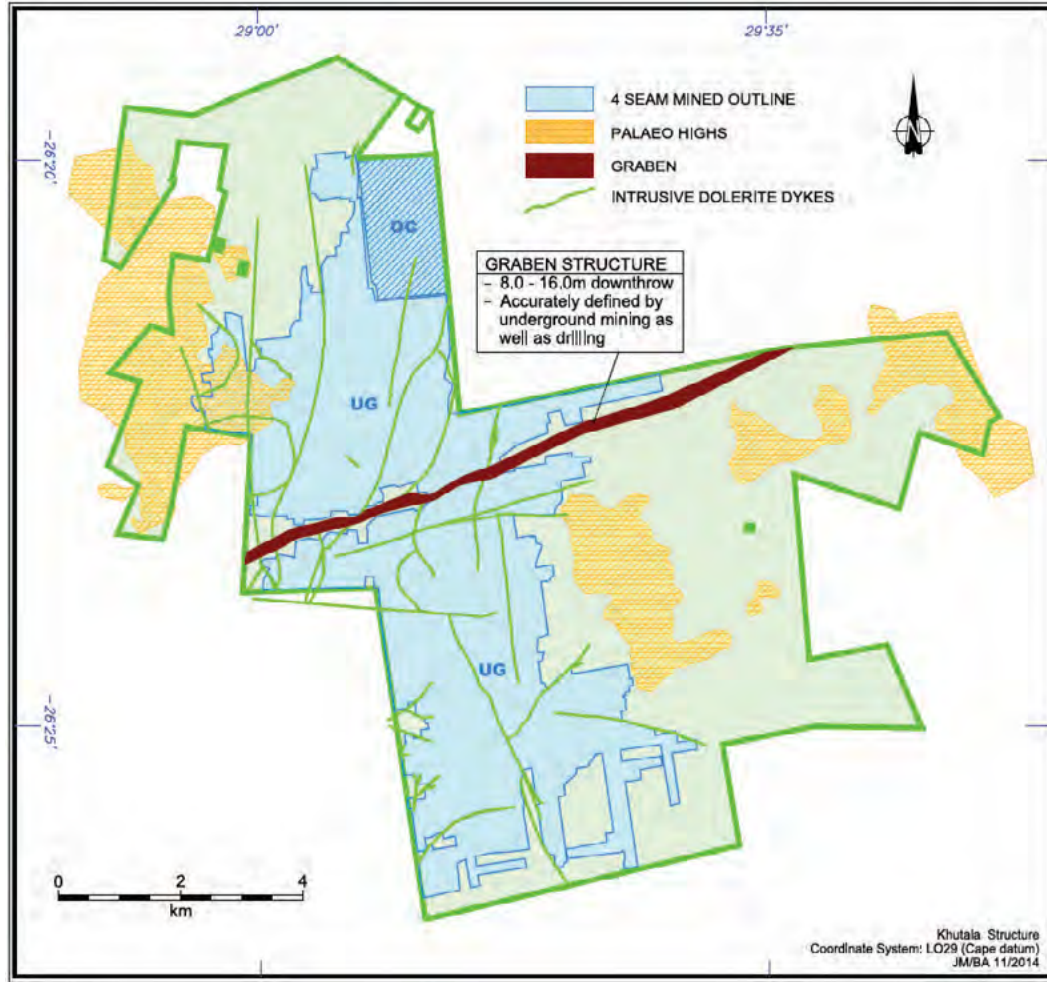

Source: SAEC

Figure 5.45: Cross-sections through Khutala showing the effect of palaeo-highs

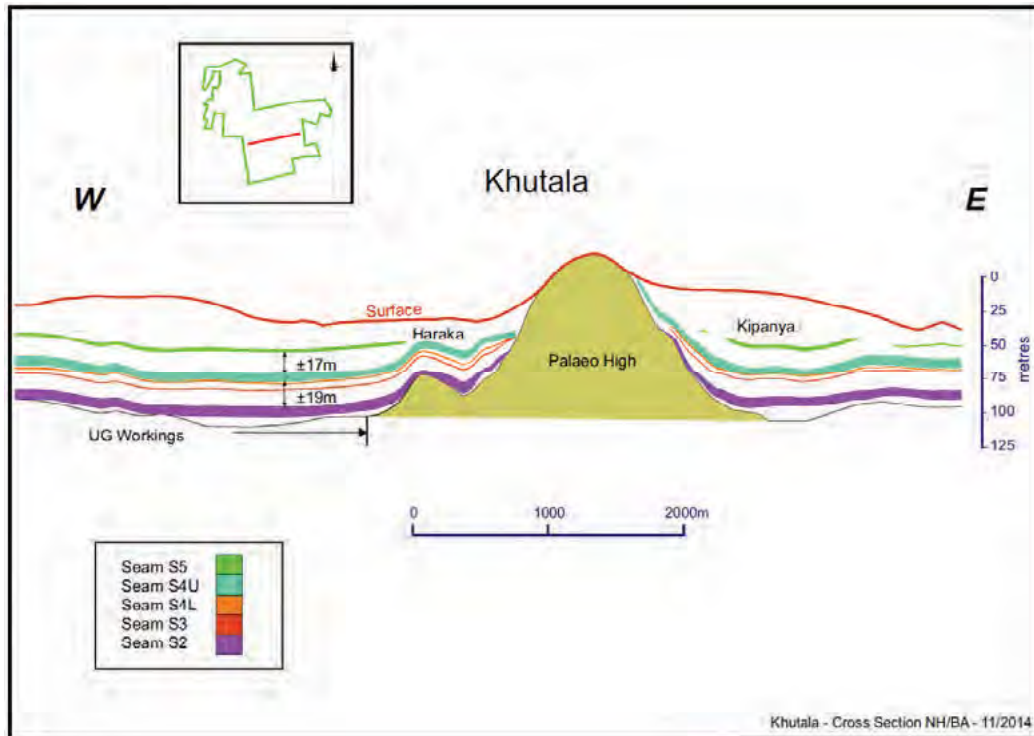

Source: SAEC

The No.4L, No.3, No.2A and No.1 Seams are not economically significant. These seams are either too thin, inconsistently developed, or of too poor quality to be considered.

In general, the coal-bearing strata are flat lying with little structural disturbance to the coal seams. However, a major graben structure bisects the Khutala property striking northeast-southwest and effectively divides the property into distinct northern and southern areas, as shown in Figure 5.44. This structural feature comprises a down faulted block with throws up to 16 m and is on average 120 m wide.

A number of identified dolerite dykes transect the property and have led to coal devolatilisation in immediate proximity to the dykes. The dykes are generally less than 2 m in thickness, are near vertical and cause fracturing and deeper than normal weathering along their contacts. The dykes do not pose a material issue to mining.

Intra-seam partings comprised of sandstone, mudstone and siltstone are prevalent in the No.2 Seam south of the graben, and mainly south of the current No.2 underground workings. These discontinuous layers and lenses occur at different heights within the seam and are difficult to correlate. Argillaceous parting material is present mainly towards the top half of the seam with the sandstone parting concentrated near the bottom of the No.2 Seam. The sandstone lenses vary in size and shape and are difficult to predict. These hard lenses can be as small as 100 m² and present cutting problems for Continuous Miner sections. The thickness of these lenses varies from centimetres up to 2.8 m.

Intra-seam parting within the No.4U Seam consists mainly of argillaceous material which poses less of a problem for mining operations.

The No.5 Seam is consistently developed across Khutala area, and where absent is mainly due to weathering effects and to a lesser extent termination against palaeo-ridges. This

good quality bright-banded coal with an average seam thickness of 1.95 m and is not dedicated to Eskom.

The depth of cover above the seams generally increases to the south of Khutala. The depth to the roof of the No.4U Seam is approximately 100 m along the southern edge of the property while the depth to the No.2 Seam is approximately 130 m and is approximately 87 m for the No.5 Seam.

The parting thickness between the two top seams is fairly constant while the thickness between the No.4U and No.2 Seams increases from approximately 10 m in the north to 20 m in the south.

5.4.4 Coal Resources

Base data for Coal Resource estimation

Figure 5.46 shows the borehole distribution at Khutala available for geological resource modelling and estimation. The plan shows recent and historical drilling, and planned drilling for FY15.

Figure 5.46: Borehole distribution at Khutala

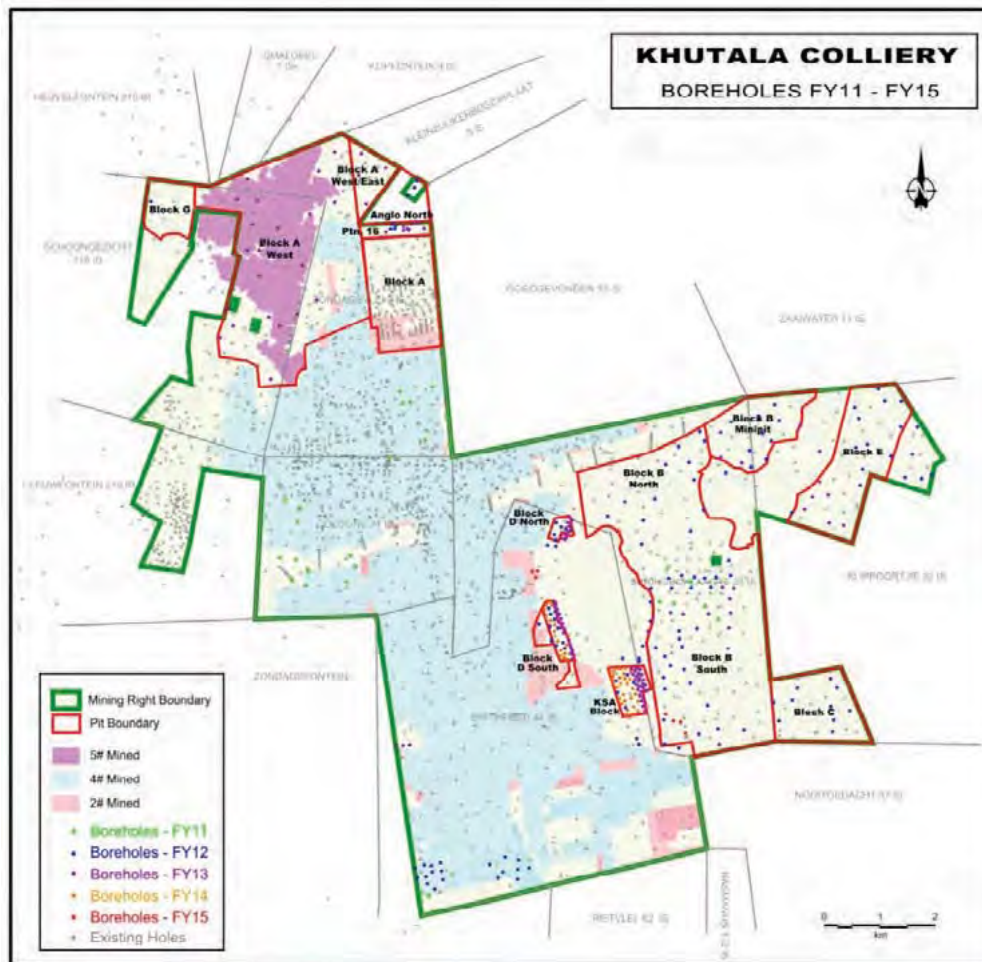

Source: SAEC

Coal Resource statement

Coal Resources are estimated and reported by SAEC in accordance with the guidelines set out in the JORC Code and are detailed in Table 5.35.

Table 5.35: Khutala Mine Coal Resources (adb), as at 30 June 2014 on a 100 per cent basis (No.4U and No.2 Seams assigned to Eskom, No.5 Seam assigned to SAEC)

Resource Class	Seam/Ply	Average Thickness (m)	Tonnes in-situ (Mt)	Ash (%)	Volatiles (%)	Total Sulphur (%)	Calorific Value (kcal/kg)
KHUTALA MINE UNDERGROUND							
Measured	No.4U	5.82	46	36.6	21.0	1.07	4,250
Measured	No.2	7.50	141	32.8	20.3	0.82	4,560
Indicated	-	-	-	-	-	-	-
Inferred	-	-	-	-	-	-	-
KHUTALA MINE OPENCAST							
Measured	No.5	1.89	0.1	21.1	28.6	2.32	5,810
Measured	No.4U	4.48	1.1	41.2	20.1	1.11	3,990
Measured	No.2	2.41	0.9	24.2	24.6	1.60	5,590
Indicated	-	-	-	-	-	-	-
Inferred	-	-	-	-	-	-	-
KHUTALA OPENCAST PROJECT AREAS							
Measured	No.5	1.92	171 ¹	18.1	30.5	1.76	6,110
Measured	No.4U	5.48	511 ²	36.1	20.9	1.16	4,370
Measured	No.2	5.71	458 ²	31.5	20.7	0.95	4,780
Inferred	-	-	-	-	-	-	-
Total Measured			1331	31.8	22.0	1.12	4,750
Total Indicated			-	-	-	-	-
Total Inferred			-	-	-	-	-
TOTAL KHUTALA			1,331	31.8	22.0	1.12	4,750

Source: SAEC

Notes:

1. 133 Mt of the total 171 Mt No.5 Seam resource occurs as virgin seam located above workings in the Khutala underground area
2. 467 Mt of the total 970 Mt No.4U+No.2 Seam resource occurs as remnant pillars in the Khutala underground area

All No.4U Seam and No.2 Seam Coal Resources at Khutala are contracted to Eskom. No.5 Seam is for SAEC's account.

Coal Resources within the Khutala mine underground and opencast (Block A) areas are reported Inclusive of Coal Reserves.

There are no Coal Reserves associated with the Coal Resources reported within the Khutala opencast project areas. These resources include virgin No.4U Seam and No.2 Seam opencast resources as well as the No.4U Seam and No.2 Seam remnant pillars in the underground area, and virgin No.5 Seam overlying the underground workings.

Seam thickness cut-offs for resource estimation are set at 2.5 m for underground resources and 1 m for opencast resources. Coal Resource classification is based on raw coal quality points of observation.

5.4.5 Coal Reserves

Khutala's publicly stated Coal Reserves as at 30 June 2014 are presented in Table 4.9, while the Coal Reserve cut offs are as shown in Table 4.11.

Khutala's current production target of 7.5 Mtpa, reducing to 3 Mtpa over the remaining six years of life, is considered reasonable as the underground mine reserves are depleted over this period.

There was a depletion of underground Coal Reserves at Khutala Mine due to production of 8.4 Mt from 47 Mt ROM to 38.6 Mt ROM with a negative change in overall Reserves by another 2.7 Mt ROM due to some changes in geotechnical parameters being applied to the layout plans where poor roof conditions may be encountered, which has resulted in a June 2014 Coal Reserve of 35.9 Mt ROM. The Opencut Reserves for Khutala will be depleted by March 2015.

With regards to the tonnages within the Khutala Coal Reserve, the geological and economic boundaries of the underground operation were determined based on the boundary of the Khutala Mining Rights, economic cut-off thickness and for safety reasons a distance limit from the point of safe exit from the mine.

SAEC developed a financial model on the estimated production, mining and processing costs and capital expenditure to demonstrate the economic viability of extracting these Coal Reserves.

Reconciliation and modifying factors

For the No.2 Seam, the geological losses applied are around 2 per cent based on historical data, other losses have been running at between 4.4 per cent and 2.6 per cent in the FY12 and FY13 respectively. Waste dilution has been estimated at 0.05 m in the floor (No.2P) and 0.03 m in the roof (No.2F) of the No.2 Seam.

For the No.4 Seam, the forecast geological losses are estimated at 2 per cent based on historical figures and other losses at 8 per cent based on recent losses (estimated 7.5 per cent in FY12 and 4.3 per cent FY13).

Table 5.36: Seam Modifying Factors

Modifying factors		
Coal Losses	No.2 Seam	No.4 Seam
Floor (m)	Nil	Nil
Roof (m)	Nil	Nil
Other losses (%)	14	8
Geological losses (%)	2	2
Waste Dilution		
Floor	0.05 m (No.2P)	0.10 m (No.4U)
Roof	0.03 m (No.2F)	Nil (No.4U)

Source: SAEC Khutala_RP&D_LOA Design criteria

The Khutala underground Coal Reserves have been well defined and are all appropriately classified in the Proved category. Approximately 29 per cent of the Coal Reserves are derived from the No.4 Seam and 71 per cent from the No.2 Seam (Table 5.37 and

Table 5.38).

Table 5.37: Khutala Mine Underground Coal Reserves by seam (adb)

Reserves	June 2014 ROM (Mt)
No.5 Seam	Nil
No.4 Seam	10.4
No.2 Seam	25.5
Total	35.9

Source: SAEC 30 June 2014

Table 5.38: Khutala Mine Underground Coal Reserves (adb)

Project	Mining Method	Proved	Probable	Total	Proved Marketable Reserve				Probable Marketable Reserve			
		Mt ROM (adb)	Mt ROM (adb)	Mt ROM (adb)	Mt (adb)	Ash (%)	CV (kcal/kg)	TS (%)	Mt (adb)	Ash (%)	CV (kcal/kg)	TS (%)
Khutala (June 2014)	Underground	36	0	36	33	33.6	4,440	0.76	-	-	-	-
Khutala (Dec 2014)	Underground	32	0	32	29	33.6	4,440	0.76	-	-	-	-

Source: SAEC

Table 5.39: Khutala Mine Opencast Coal Reserves (adb)

Project	Mining Method	Proved	Probable	Total	Proved Marketable Reserve				Probable Marketable Reserve			
		Mt ROM (adb)	Mt ROM (adb)	Mt ROM (adb)	Mt (adb)	Ash (%)	CV (kcal/kg)	TS (%)	Mt (adb)	Ash (%)	CV (kcal/kg)	TS (%)
Khutala (June 2014)	Opencast	1.4	0	1.4	1.3	35.7	4,640	1.15	-	-	-	-
Khutala (Dec 2014)	Opencast	0.2	0	0.2	0.2	35.7	4,640	1.15	-	-	-	-

Source: SAEC

To the east of the current workings, all seams are cut by a palaeo-high. On the eastern side of this paleo-high is the Khutala life extension project an area currently being evaluated for its potential to support an opencast operation extracting all seams. The Khutala life extension project is discussed in further detail in Section 5.4.15.

In addition, SAEC has identified a number of options to develop several mini open pits; (i) one to the west of Block A (approximately 850 kt), (ii) a small open pit to the southeast of Block A (KSA Mini Pit approximately 4 Mt), and (iii) a small underground mine accessing No.5 Seam at the southern end of what is referred to as Block A.

In addition, options exist to develop access to further underground workings in the area to the north and south of the paleo-high (approximately 25 Mt from both No.2 and No.4 Seams).

5.4.6 Mining

Overview

Khutala is predominantly a large underground bord-and-pillar mining operation with coal extracted from the No.2 and No.4 Seams. Limited opencast mining is also carried out to extract coal seams (principally No.5 Seam) which are considered too shallow to mine by underground methods, mainly in the northern section of the mining right the opencast operation should be complete by March 2015.

Khutala is an owner-operated mine with contractors used to assist in specialised services underground and for open cast mining.

The mine produced an average of 9.5 Mtpa ROM (2012 to 2014) from the underground and the opencut operation production has declined from 4.6 Mtpa ROM in 2012 to 70,000 tpa ROM in 2014.

Opencast coals from the No.2 and No.4 Seams supplement the underground production and is sent through to the Eskom's Kendal plant. Coal from No.5 Seam is of higher quality and is sold outside of the Eskom contract.

The No.2 and No.4 Seam coals are supplied to Eskom in a raw state, meaning no beneficiation is required. The coal is only crushed to a manageable size (-25 mm) and transported to Eskom via a conveyor system.

Mining methods and access

Underground

The mechanised bord and pillar method is widely used in the South African coal mining industry, as it offers a number of advantages in thick, gently undulating coal seams. These advantages include high extraction rates, increased productivity, and availability of equipment and familiarity of the local workforce with the technique and associated equipment.

The Khutala underground has been in operation since the early 1990s and to date has extended over an area of some 7,000 ha, measuring 12,000 m north-south by 8,000 m east-west and to a depth of 120 m below surface. Current underground mining at Khutala is focussed on 13 sections; nine sections extract coal from the No.2 Seam, while four sections target the No.4 Seam.

The current underground mining method is to use modern mechanised continuous miners in all working sections. Both the No.2 and No.4 Seams are mined using continuous miners,

mechanised roof bolters, electric shuttle cars and feeder breakers. The broken coal is loaded onto a network of conveyor belts, which transport the coal to surface.

Each continuous miner section comprises nine roadways; seven of these are used as intake airways and the remaining two as return airways. In plan view, this creates chequerboard pattern of 'bords' (comprising headways and cut-throughs), which provide access, and blocks of uncut virgin coal blocks ('pillars'). The pillars support the overlying strata, while the headings/cut-throughs are supported by roofbolts. The depth of working is the key determinant impacting on the dimensions of the pillars and the size of each bord. As depth increases so does the size of the pillar, which then affects extraction and production rates. This nine-road configuration minimises the frequency of belt extensions, without infringing on the trailing cable length of machines when mining the extremities of the panel. The coal seam is mined with thick seam continuous miners.

Men and material access the mine via a large 12 m diameter vertical shaft. A decline shaft provides access for the conveyor system. The mine is also supported by a number of vertical up-cast ventilation shafts.

The extent of the underground mine workings is constrained by proximity to surface, an east-west trending graben structure, the palaeo-high, seam thickness, coal quality and geological features, such as faults and dykes and sandstone partings (especially in the No.2 Seam).

For safety reasons, SAEC has confined its underground workings to the "the golden hour", which enforces a distance limit based on how long it would take to transport an injured person to the mine shaft, which must be no more than one hour travelling time. In practice, this has little effect on the Coal Reserve estimate.

Production rates are typically related to extraction seam height and pillar sizes, with thicker seams achieving higher production rates. Extraction rates in "first workings" typically range from 30 to 50 per cent of the defined Coal Resource. At Khutala, current extraction rates in unbroken coal seams are 45 to 48 per cent.

Coal is conveyed to the surface where it first passes through a destoning facility before being conveyed through to a single stockpile. The coal is then transferred directly by conveyor to Eskom's Kendal power station.

Opencast

There is a small opencast operation in the North section of the Mining Right known as Portion 16, which is currently mined via a traditional truck and shovel mining technique for extraction of the coal seams. This operation extracts coal from the No.5, No.4 and No.2 Seams.

Mining uses a series of strips and cuts over a wide area, where the surface is relatively flat and the coal seams comparatively shallow. The stripcut initially started as a boxcut with 40 m access ramp, which was then advanced to a 500 m strip cut with ramps being moved and placed as space became available in the low wall.

A contractor has been appointed to mine the opencast, with the capacity based on volumes that were mutually agreed by the contractor and SAEC's Khutala Integrated planning department. Currently, opencast mining at Portion 16 has been running at an annual rate of 1.2 Mtpa, with mining forecast to be complete by December 2014. The operation is concentrated in a shallow subcropping area with an average strip ratio of 3:1 bcm/t ROM.

The No.5 Seam is hauled to Klipspruit, while the No.2 and No.4 Seams are hauled to a conveyor system where it is combined with the underground coal.

Mining fleet

SAEC's current underground mining fleet at Khutala is summarised in Table 5.40.

The opencast is mined by MCC Contracts Pty Ltd, a contractor fleet. This contract is due to expire in December 2014 but can be extended to coincide with the final depletion of the currently defined opencast Coal Reserves by approximately March 2015.

Table 5.40: SAEC's Underground Mining Equipment Fleet

Machine	No.s of units	Capacity
Joy Continuous Miner (12HM31B)	12	800 -1220 t/shift
Joy Continuous Miner (12HM21)	2	700-900 t/shift
Fletcher roof bolter (HDDR-AC-5.5 m)	8	Twin boom
Rhyam roofbolter	6	
Joy shuttle car (SC 10SC32 -56C)	42	16 – 20 t
Buffalo feeder breaker	14	Primary crusher

Source: SAEC Khutala_RP&D_LOA_Design_Criteria

Geotechnical design and hydrology considerations

A comprehensive Code of Practice covering rock falls and wall instability has been established for Khutala. This document outlines a history of previous incidents, as well as future actions to minimise the likelihood of future incidents.

From 1 January 2012 to date there has been six personal injuries from rock falls, with five falls from the roof and one rock fall from the pillar side. None of the injuries were classified as lost time injuries.

One major roof fall took place in the belt road in the graben on No 2 Seam at Khutala which resulted in structural damage to the trunk conveyor. Remedial support and repairs took a relatively short time to complete.

SAEC's rock engineering department design the underground workings as well as anything that will affect the stability of the workings. The pillars are designed in accordance with legal requirements of the *Mine Health and Safety Act, 1996 (Act no 29 of 1996)*, Regulation Chapter 17 and SAEC internal guidelines. The minimum design safety for the secondary and primary development panels is 1.6 and 2.0 respectively. Xstract consider these design parameters to be reasonable and appropriate for the mining conditions. No pillar extraction, bottom coaling and shallow mining will be carried out over the remaining life of the underground workings at Khutala.

For the No.2 Seam, the mining height is between 3.8 and 4.5 m, with a mining width of 6.0 to 6.8 m. Production rates for No.2 Seam are estimated assuming (i) the Joy 12HM31 machines are in good conditions at 907 t/cm/shift, and (ii) the Joy 12HM21 machine at 760 t/cm/shift (Table 5.41). These were then de-rated according to the Good (100 per cent), Moderate (85 per cent) or Bad (60 per cent) classification appropriate to prevailing mining conditions.

For the No.4 Seam, the assumed mining height is between 3.8 and 4.5 m, and a mining width of between 6.0 and 6.8 m (Table 5.41). The Joy 12HM31 in the No.4 seam were rated at 1075 t/cm/shift, based on historical data and the de-rated according to the Good (100 per cent), Moderate (85 per cent) or Bad (60 per cent) classification for prevailing mining conditions.

Table 5.41: No.2 and No.4 Seam design summary

Seam Design Parameters	
Mining Height	3.8 m to 4.5 m
Mining Width	6.0 m to 6.8 m
Mining Method	Bord and Pillar
Primary mover	Joy Continuous Miner (12HM31B) and Joy Continuous Miner (12HM21)
Mining rate (12HM31B)	907 t/cm/shift de-rated as applicable to the mining conditions
Mining rate (12HM31B) 4 Seam	1075 t/cm/shift de-rated as applicable to the mining conditions
Mining rate (12HM21)	760 t/cm/shift de-rated as applicable to the mining conditions

Source: SAEC Khutala_RP&D_LOA_Design_Criteria

There are no major hydrological constraints associated with the workings and the underground mine is relatively dry with some nuisance water, which requires pumping. There have only been occasional issues, where mining intersected previous boreholes causing water to penetrate the workings and requiring additional pumping.

Since the 1980s, collieries in Mpumalanga Province have been studied for water ingress. These studies have shown that water inflow is controlled by mining depth, with deeper mines subject to less water flow. At Khutala, SAEC elected not to carry out secondary workings, such as "stooping", as this would likely (i) increase surface subsidence, (ii) increase the safety risk due to roof failure and (iii) have an effect on water ingress. Currently water in the underground workings is controlled and there are no major water ingress issues.

Surface mining in the area is known to yield 20 times more water than the underground. The Portion 16 opencast is expected to generate water, for which SAEC plan to dispose in the former Block A workings or pump it underground.

Historical and forecast operating statistics

Productivity improvements since the mid-1990s have resulted in the number of sections being reduced from 22 (FY98) to 14 sections in FY13 and a further reduction in FY14 (to the current 13 sections).

More recently, the mine has been capital constrained, which has led to a reduction in production capacity as some sections are up to 13 km from the main shaft.

There have previously been a number of plans to improve mine infrastructure, none of which have been adopted to date.

Under the Kendal coal supply agreement, Eskom are responsible for capital expenditure relating to development of the No.2 and No.4 Seams at Khutala.

Figure 5.47: Progress plan of No.4 Seam

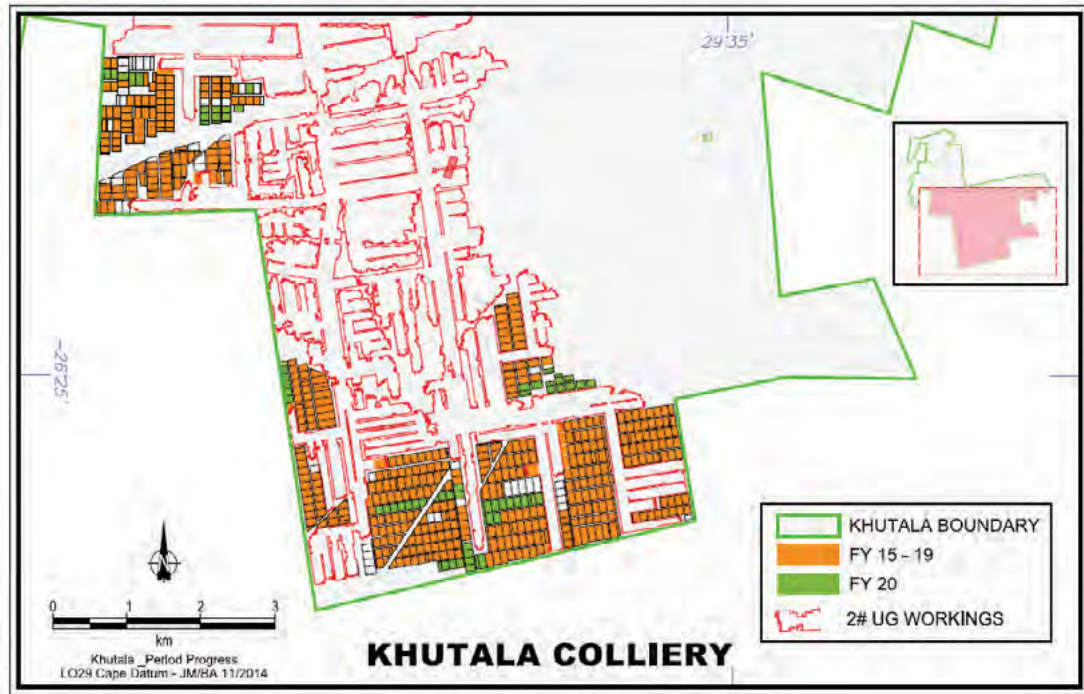

Source: SAEC Khutala_RP&D_LOA_Design_Criteria

Figure 5.48: Progress plan of No.2 Seam

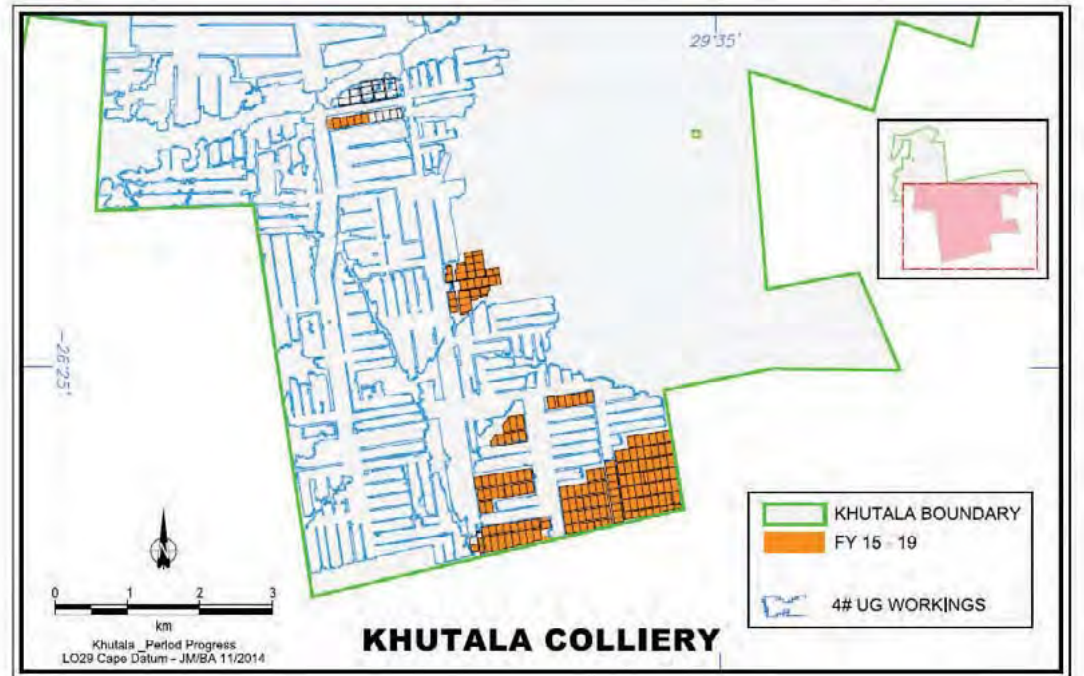

Source: SAEC Khutala_RP&D_LOA_Design_Criteria

Production schedule

Based on current production rates, SAEC expect the Portion 16 opencast Coal Reserves will be depleted by December 2014 and the underground Reserves by FY20.

In both the No.2 and No.4 Seams, faults and dykes are included in the mining plan in order to determine areas likely to be affected with areas classified as either Good, Moderate and Bad. Relevant modifying factors are then applied to estimate the likely production rate for each area.

Under the current mine plan, SAEC is expecting a shortfall relative to their commitments to Eskom in respect of supplied volumes as per the Kendal coal supply agreement. Over the near term, underground production is forecast to reduce from the current 7.5 Mtpa to around 3 Mtpa, as Khutala becomes constrained by a defined lack of underground reserves. The underground reserves are estimated to be exhausted by FY19 (No.4 Seam) and FY20 (No.2 Seam). However, final production may be achieved earlier than forecast, as productivity rates for each section are still good (especially in the No.4 Seam) and planned rates may be overachieved as mining conditions in the 4 seam are considerable better than in the No.2 Seam.

Figure 5.49 shows the historical and current forecast production plan for Khutala operation. The opencast operation is forecast to be completed in December 2014, while the number of continuous mining sections underground will reduce from the current 13 sections to eight sections by FY19, as the No.4 and No.2 Seam reserves are depleted.

Figure 5.49: Khutala production schedule - historical and forecast

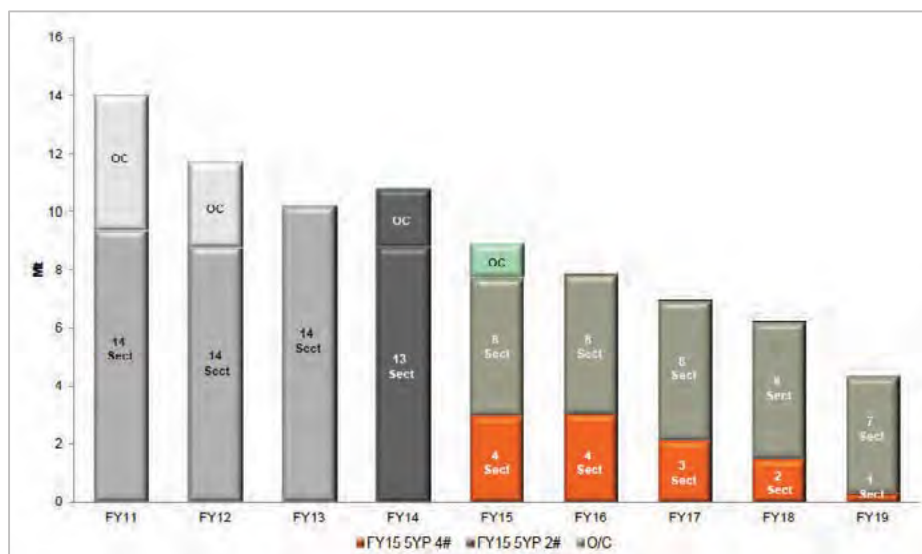

Source: SAEC

5.4.7 Equipment and manning

Current manning levels for the Khutala Mine are shown in Figure 5.50.

Figure 5.50: Employee historical and current numbers

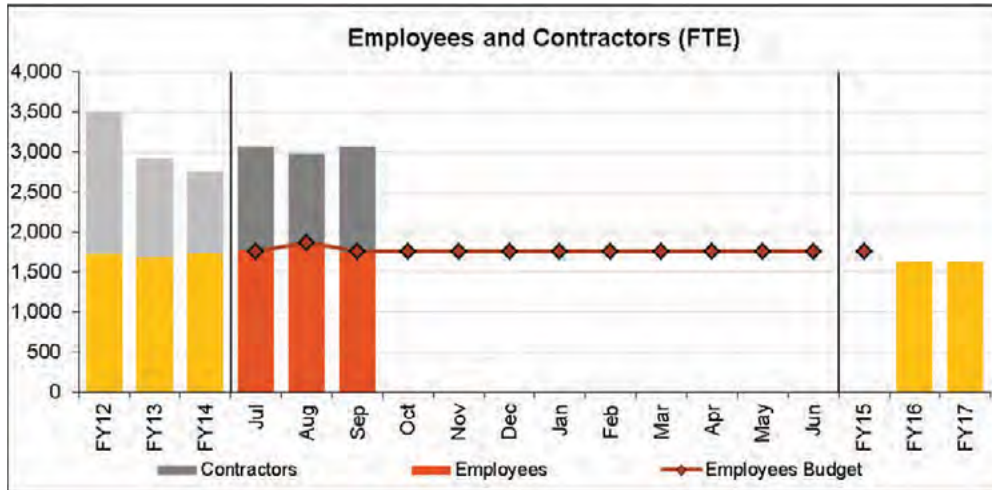

Source: SAEC

5.4.8 Management and Industrial Relations

During the Xstract's review of SAEC's operations, our project team were in regular contact and held numerous discussions with all levels of SAEC management. Based on this contact, Xstract is satisfied that SAEC has established a capable management team at Khutala. Furthermore, management understands the key drivers and risks at the Khutala Mine and have developed credible systems and operational plans to manage the mine effectively. SAEC has established a technical services group, which coordinates LOA mine planning and comprises of geological, mining engineering and environmental management.

5.4.9 Health and Safety

Xstract saw that an executive safety committee sets health and safety management policy within SAEC. Direct health and safety responsibility rests with the line management and, as is essential in the effectiveness of any system, relies on workforce involvement.

Safety performance in the last three years as expressed in Injury Frequency Rate has increased mainly due to the increase in Medical Treatment Case Frequency Rate ("MTCFR") (Figure 5.51). This increase may reflect falling employee numbers but higher productivity targets as the mine contracts resulting in an associated increase in the number of industrial claims going forward. There has been one fatality at the mine in recent years (January 2012), which involved an employee carrying out maintenance on an underground conveyor.

During Xstract's underground site visit, safety was at the forefront of the operation including a proximity detection device, which stops employees from entering zones near moving equipment, such as loaders or continuous miners. SAEC has also recently installed world-class simulators for the induction and training of underground machinery operators.

Figure 5.51: Safety statistics

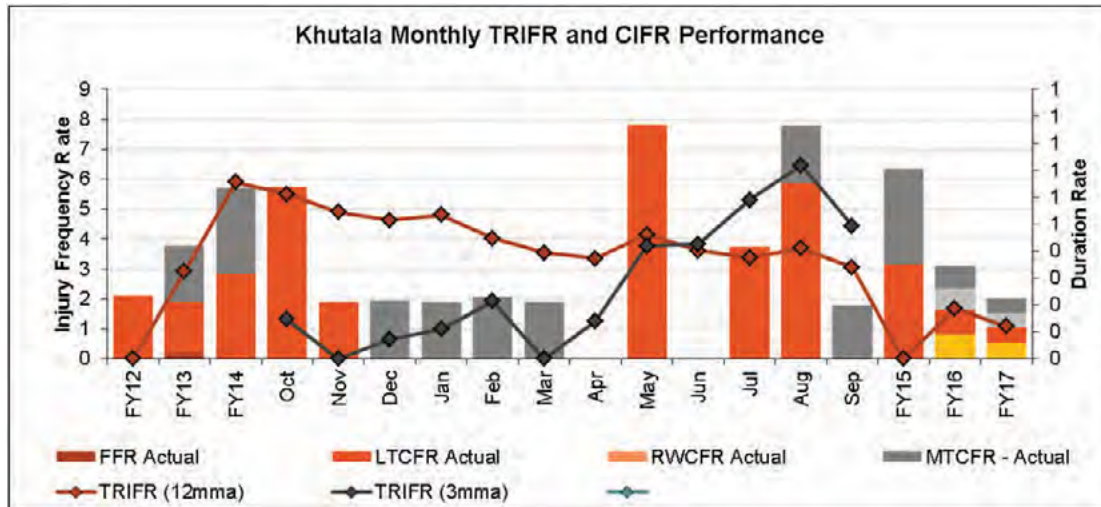

Source: SAEC

5.4.10 Infrastructure and transportation

Water

Khutala Mine receives water from Eskom, which supplies potable water to the mine at an average of 13 Ml/month. Additionally, process water is sourced from pollution control dams, which have a combined volume of 230 Ml. A potable water supply contract is in place with Eskom.

Power

Khutala Mine has a dedicated power supply to support mining operations with 11,000 MWH per month, 28 MVA maximum demand usage with Power Factor Control or 32 MVA maximum demand usage without Power Factor Control and 37.2 MVA notified maximum demand. SAEC’s LoA plan suggests that the power required to carry out mining operations can be met by the current system.

5.4.11 Marketing

Domestic market

Eskom

The Khutala Mine is contracted to supply No.2 and No.4 Seam coals to Eskom’s Kendal Power Station until 2033. The price received involves a cost plus arrangement based on a formula that includes a return on invested capital and inflation price escalation.

Eskom requires that the coal product sent from Khutala Mine satisfy Kendal’s specifications as indicated in Table 5.42.

Table 5.42: Eskom coal specifications for Khutala mine

Product Specifications	
Size	50 mm
Ash Fusion Temperature	+1,325°C
Ash Content	<33.0% (24.00 to 41.00%)
Abrasive Index	300 mg-Fe
Calorific Value (dry base)	19.6 MJ/kg (17.0 to 23.0 MJ/kg)
Volatile matter	19.0 to 23.5%
Grindability	50
Inherent moisture	2.4 to 3.7%
Total Moisture	<8.0%, maximum 9.05%
Sulphur Content	<1.0%

Source: Tati, 2011

Export market

No.5 Seam coals from Khutala are for SAEC's account. These are typically sent to the Phola plant where they are incorporated with Klipspruit coals to produce export quality products.

5.4.12 Environment and social

Environmental and social status

As Khutala is predominantly an underground operation, there is significantly less surface impacts relative to the mine's overall area.

Community relations, plans and programmes

Since there are no communities in the immediate vicinity of the mine, Khutala also supports Phola via the Community Development Initiatives. There are significant historical and planned community development projects.

Khutala is adequately upholding its social license to operate in the area.

Permitting requirements

The mine is in legal compliance with regards to the submission of these performance assessments.

There is currently uncertainty in relation to the expansion plans (Khutala life extension project) for the mine as it relates to future environmental authorisations.

The mine has indicated its intent to extract Remaining Extent ("RE") of Portion 3, as an opencast extension to Block A - Portion 16 within the next two years. This option poses a challenge as environmental authorisations have yet to be processed and there are sensitive wetlands and habitats within this area.

Potential impacts, control measures and environmental management

Surface subsidence

There is no visible subsidence or topographic disturbance over undermined areas. The mine management monitors subsidence through regular aerial photographic surveying.

Rehabilitation

Block I and Block B have been successfully rehabilitated. The surface shaping blends in with the surrounds and grass has been planted and is being grazed. These areas should be used as models for future rehabilitation due to their apparent success.

The total area disturbed on surface is estimated to remain at approximately 600 ha until FY19 (Figure 5.52). There is very little expenditure planned for surface rehabilitation, most of the expenditure planned is for redundancy in FY35 (Figure 5.53).

Figure 5.52: Total area disturbed and land rehabilitated vs annual disturbance at Khutala

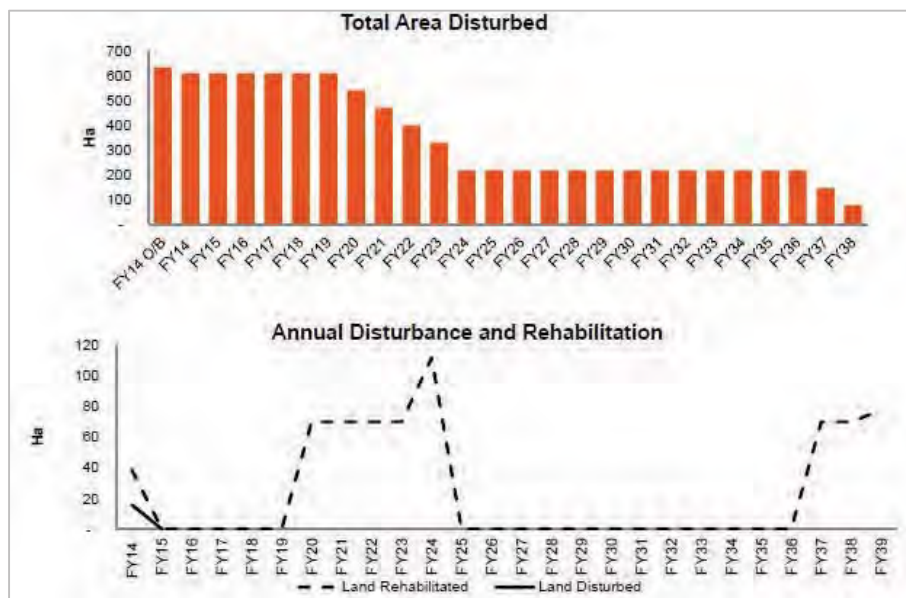

Source: SAEC 2013

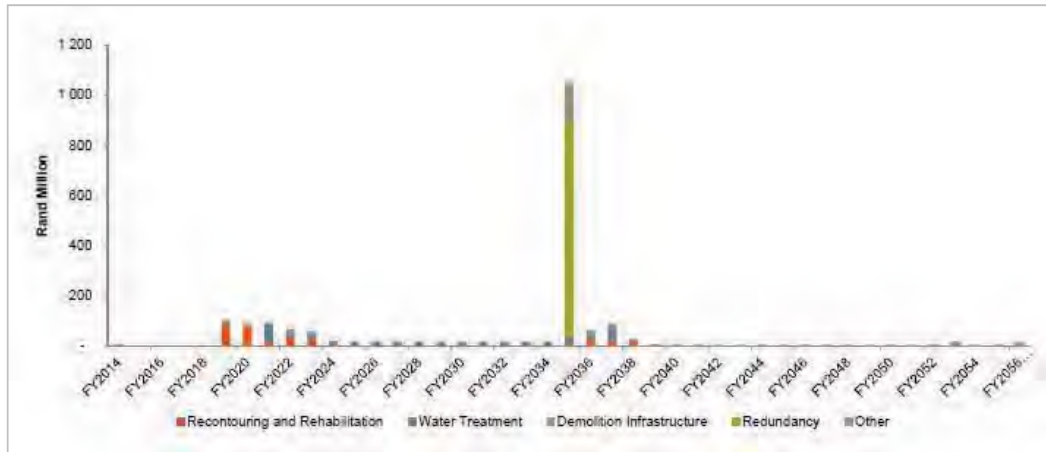
Figure 5.53: Proposed expenditure on rehabilitation at Khutala (ZAR M per annum)

Source: SAEC 2013

Wetlands and watercourses

The Khutala area contains many wetland areas and watercourses. Should plans be pursued to mine blocks by opencast methods as proposed, further environmental authorisations would be required.

Water Issues

According to Hodgson (2010), the current water inflow at the Khutala underground is very low, as there is very little surface subsidence and the recharge into deep underground workings is not significant. Block A, and two of the three pits at Block I are currently decanting and water is pumped into the old underground workings. A transition to dominantly opencast mining would result in a significantly higher water balance (i.e. typically up to 20 times more than the recharge into underground workings). If appropriately managed, Khutala should not have a water management problem.

All workings should be full by 2050, whereafter decant will be in the range of 4 to 6 Ml/day.

Eskom is responsible for costs associated with water management and treatment of Block A, while SAEC is responsible for costs at Portion 16. Block A and Portion 16 are hydraulically and hydrogeologically linked. According to Golder Associates (2013), Portion 16 comprises 13 per cent of the total water inflow during operation and 8 per cent post closure.

Closure planning

In SAEC's 2013 Closure Plan, a Deterministic Closure Liability quantum for Khutala as at 30 June 2013 amounts to ZAR487 M. The closure liability provides for demolition of infrastructure, water treatment, removal of roads and railway lines, etc. The estimated costs are appropriate for an operation of this size. Eskom is responsible for rehabilitation associated with mining of the No.2 and No.4 Seams as per the contracted supply agreement. SAEC is responsible for all costs related to the No.5 Seam workings. Khutala is planned to close in FY18/19, should the Khutala life extension project not be approved.

A detailed closure plan report will be required immediately should no further projects be pursued. Such a report is to be compiled and submitted to the DMR, as there is a requirement that approval is sought five years prior to closure.

The area covered by the Block A opencast is the only substantial surface disturbance which requires rehabilitation.

5.4.13 Cost assumptions

Total cash costs

The mining cost at Khutala account for 44 per cent of total cash costs (Figure 5.54). This includes bord and pillar mining, as well as coal handling delivered to the Kendal power station. A further 14 per cent is estimated for rehabilitation costs. Administrative and overhead costs account for the remaining 34 per cent of total costs.

The royalty paid to the State is reimbursed in full by Eskom and therefore Xstract has assumed a net zero position.

Figure 5.54: Khutala cash operating costs

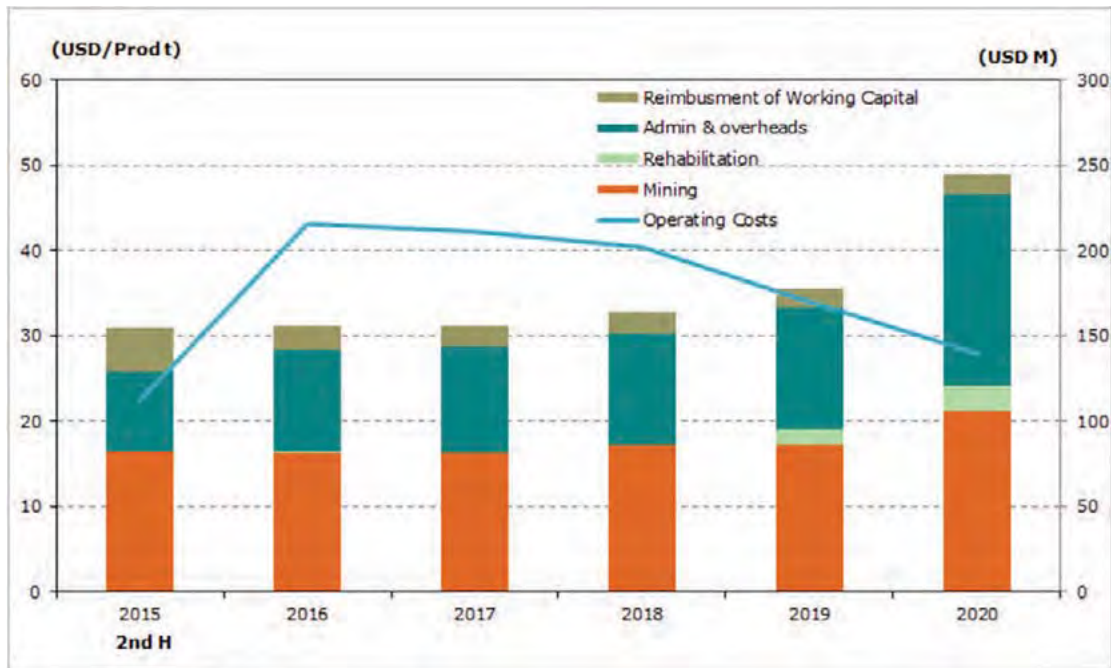

Source: Xstract estimates

The long-term underground mining cost of ZAR192.69/t Product takes into account the reduction in tonnage as the mine nears closure. The near term valuation model for the years FY15 to FY17 averages ZAR184.83/t Product, which is considered by Xstract to be appropriate for an operation of this scale.

Table 5.43: Historic actual underground mining costs

Item	Unit	Actual FY12	Actual FY13	Actual FY14	Long term	Unit	Long term
Underground mining cost	ZAR/Prod t	165.65	184.81	180.68	192.69	USD/Prod t	17.10

Source: SAEC, Xstract estimates

Table 5.44: Forecast underground mining costs (nominal)

Item	Unit	FY15 H2	FY16	FY17	FY18	FY19	FY20
Underground mining cost	ZAR/Prod t	188	200	211	236	247	323

Source: SAEC, Xstract estimates

Capital expenditure

All capital expenditure is funded by Eskom. This includes overhaul and replacement of mining equipment, as well as development and project working capital. It is estimated to total USD94 M over the remaining Reserve life. It is significantly less on an annual basis, than past expenditure and tails off towards the end of Reserve life.

Table 5.45: Khutala Capital Expenditure (real)

Item (USD M)	FY15 H2	FY16	FY17	FY18	FY19	FY20- beyond
Sustaining	18.2	19.3	16.1	16.8	10.3	11.4
Closure	-	-	-	-	-	1.6

Source: Xstract estimates

Closure costs

Closure costs are allocated to operating costs as rehabilitation concurrent to mining and extending beyond the life of production. A total of USD168 M (real) is estimated for the period from 2015 to 2055. Under the coal supply agreement, SAEC is reimbursed for this expense by Eskom. An estimate for redundancies has been made in the final production year. Salvage value of plant is not material and has not been considered.

5.4.14 Risk and opportunities

Risks

Geology

There is a risk of poor coal quality associated with in-seam parting material included during opencast mining.

Seam dips can reach 15° on the flanks of palaeo-highs.

Dilution associated with opencast mining of No.4U and No.2 Seam pillars in the current underground area.

Mining

Mining carries inherent risks, which are a function of the geological setting and mining methods. These risks can be minimised but are very rarely totally removed. SAEC appears to have a robust risk management system at Khutala whereby risk and opportunities are recognised and are controlled over time by risk identification and controls put in place.

Xstract noted the following issues:

- Underground mining in areas outside the “golden hour” increases the risk to employees, due to the response time during an emergency. This has been effectively managed by SAEC through their policy of not mining beyond these limits.
- Mining performance in the near term could actually improve thereby exceeding the planned output and ultimately shortening the mine life. This may lead to a shortfall between the completion of the Khutala mine and the commissioning of the Khutala life extension project (if approved).

Environment

The highest potential risk for Khutala from an environmental perspective is the uncertainty concerning the future mine planning. As noted in SAEC’s Competent Person Report (2014), obtaining environmental authorisations for future expansion projects at the mine could take up to three years. Thus from the point of certainty, a considerable period of time could lapse before projects are initiated. The Khutala Mine is well run from an environmental perspective, noting exceptional rehabilitation efforts and management of spontaneous combustion.

Opportunities

Geology

An opportunity exists to exploit some 133 Mt of virgin No.5 Seam Measured Coal Resources by opencast methods overlying the underground workings. Such an opencast operation may also target the underlying No.4U and No.2 Seam pillars.

Mining

The largest opportunity is the expansion of the Khutala mine by expanding mining through the Khutala life extension project, which is outlined below. Studies have also been undertaken into some smaller opportunities to expand the current operations for example through small opencast operations west of the palaeo-high and associated underground workings.

5.4.15 Khutala life extension project development proposal

Introduction

The Khutala Mine was originally designed as an open cast mine with a life in excess of 30 years, however due to the unavailability of mining equipment during the sanction era in South Africa the design was changed to an underground mine.

Due to the extraction methodology (bord and pillar, which involves a high degree of sterilisation) the Khutala Coal Reserve has been depleted at a higher rate that it would have as an opencast operation. In addition, as underground mining progresses the coal seam is becoming significantly shallower and future extraction of coal will have to occur via opencast methods, as it will soon become unsafe to mine underground as such shallow depths. The Khutala Mine therefore needs to be recapitalised in order to re-establish the operation as an opencast mine.

For various reasons the recapitalisation was delayed, and as a result, the opencast was not commissioned timeously to replace diminishing underground Coal Reserves and hence a supply gap has emerged. At current extraction rates, the Khutala underground Coal Reserves are forecast to be depleted within six years.

In order to extend the Khutala mine life, SAEC and Eskom are jointly evaluating Khutala life extension options, which represent the progressive transition from underground to opencast mining of the remaining Coal Resources located:

1. to the east of the known palaeo-high present within the Khutala Mining Right, and
2. around the defunct Kendal underground room and pillar mine, in the north of the Khutala Mining Right (refer to Figure 5.55).

Having carried out Selection Phase Studies ("SPS") in 2013 and 2014, which detail the planned mining and costings for the Khutala life extension project resource base. It is SAEC's intent to complete further studies in order to convert the defined Coal Resources to Coal Reserves in the near term. These current Coal Resources equate to approximately 416 Mt gross tonnes in-situ ("GTIS") of which 346 Mt ROM is classed as mining inventory for the mine taking into account geological losses and practical mining thickness cut-offs have been applied (greater than 1 m seam thickness, less than 45 per cent ash and a calorific value exceeding 15 MJ/kg).

Figure 5.55: Location of proposed Khutala life extension project (2019 to 2043)

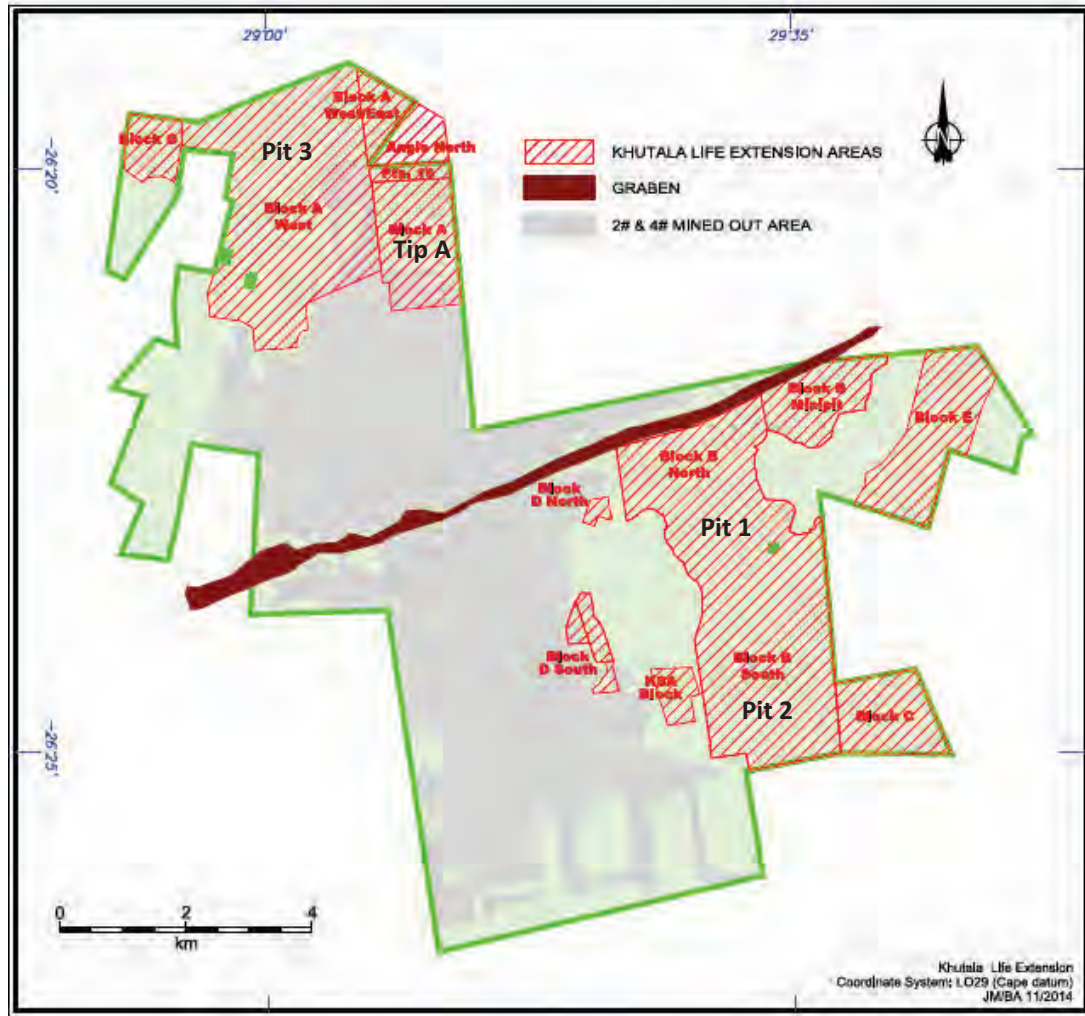

Source: SAEC

SAEC has lodged an amendment with the DMR to include the opencast mining of defined Coal Resources within the Khutala Mining Rights. This amendment is expected to be completed in 2014/15.

Under the current plan, Khutala life extension project is to be mined by opencast methods targeting the No.5 Seam (for export), as well as the No.2 and No.4 Seam to supply Eskom.

Mining method

The overburden and interburden stripping is planned to be removed either by large hydraulic shovels equivalent to a Komatsu PC 8000 shovel or electric rope shovel operations. Separate coaling fleets will transport the coal from the pit to a ROM stockpile. The coal is then transported by conveyor to a central plant, where coal could either bypass directly to Kendal power station or to a newly constructed wash plant. The new wash plant could improve the No.2 and No.4 Seam coal specification reducing impurities and increasing calorific value to product qualities agreed with Eskom. The plant is a discussion point for Eskom to consider.

The current mine design is planned to produce approximately steady state of approximately 17.5 Mtpa ROM or 13.3 Mt saleable. Aggregate ROM production of around

318 Mt of ROM coal from No.2 and No.4 Seams and around 28 Mt ROM from the No.5 Seam. The opencast layout has been designed to mine with an average strip ratio around 4.4 bcm/t ROM.

Three pits are currently planned (Figure 5.55). Pit 1 is to be excavated from a box-cut located to the east of the palaeo-high and is expected to reach a mining depth of around 65 m with a strip ratio of around 2.6 bcm/t ROM. Pit 2 is located south of Pit 1 and will be mined to a pit depth of 115 m and a strip ratio of 4.9 bcm/t ROM. Pit 3, is located in the far north of the mining right which will encompass mining virgin coal and mining pillar remnants of the old Kendall mine with a pit depth of 105 m and a strip ratio of 6.3 bcm/t ROM.

Overburden access is provided by high wall ramps and terminating with one or two wall end ramps depending on the pit configuration.

Historical production

There has been no previous coal production east of the Paleo high but in the northern area there is the old Kendal underground room and pillar mine, Pit 3 is envisaged to be an opencast coal operation mining the remnant pillars of No.4 and No.2 Seams and the virgin coal of No.5 Seam.

Forecast production

The LOA schedule for the anticipated Khutala life extension project production was updated by SAEC in 2014. Figure 5.56 summarises the anticipated ROM production schedule for the LOA plan.

Figure 5.56: Forecast ROM coal production from No.2, No.4 and No.5 Seams

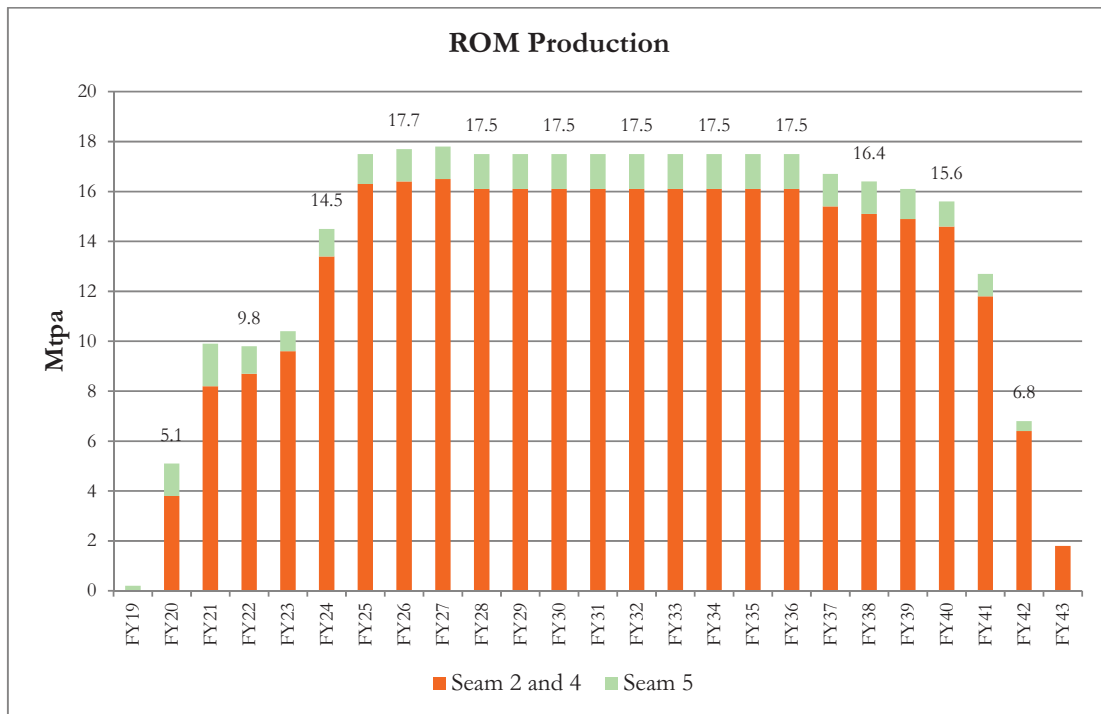

Source: SAEC and Xstract

In order to progress the Khutala life extension project, SAEC and Eskom must complete a definitive feasibility study in 2015 and gain Eskom's approval in H1 2016 in order to progress to mine commissioning by H1 2018. Production is expected to commence in early 2019 and extend to 2043. Currently, there is a comprehensive environmental study underway.

Based on initial cost studies, capital expenditure is currently estimated at ZAR25 bn (on a real basis 2014). In Xstract's opinion, these expenditures appear relatively high for this type of operation and there may be opportunities for these costs to be optimised with on-going studies.

6 Development assets

6.1 Introduction

In addition to its granted Mining Rights, SAEC holds a 100 per cent interest in a number of granted Prospecting Rights of which certain are considered key to SAEC's future initiatives to replace diminishing reserves at its Mining Assets. The Klipspruit Extension, Leandra (North and South) and Naudesbank Projects are key development projects going forward. As such, these assets are considered material for the purposes of this Competent Persons Report and are reported in detail in the following section.

6.2 Klipspruit Extension

6.2.1 Introduction

The Klipspruit Coal Reserves are expected to be exhausted in FY20. SAEC is currently investigating the Klipspruit Extension ("KPSX"), which encompasses the Weltevreden Coal Resource area and the Klipspruit South area. Mining of KPSX would allow an extension to Klipspruit's mine life of approximately 50 years.

In order to maintain a steady production profile going forward, SAEC intends to (i) incorporate its Weltevreden Prospecting Rights into its existing Klipspruit Mining Right, and (ii) amend its Klipspruit Work Programme to mine the Klipspruit South area via opencast methods.

6.2.2 Weltevreden Coal Resource Area

The Weltevreden Coal Resource area lies immediately northeast of SAEC's Klipspruit and Khutala Mines and the associated Phola coal processing infrastructure. It is centred at latitude 25°58'38" S, longitude 29°05'30"E and elevation 1,530 m in Mpumalanga Province.

The N12 National freeway passes through the southern portion of the project area, with the town of Witbank lying some 18 km to the east. Branch lines with connections to the Richards Bay Rail Line extend along the project's eastern boundary. The closest towns to the Resource area are Phola, an informal settlement, which lies immediately adjacent to the project's western boundary, and the town of Ogies some 2 km to the south.

The Resource area consists of gently undulating topography with the major land use comprising maize growing and lesser grazing.

There is a minor north-draining stream in the area with associated wetlands.

6.2.3 Land tenure

SAEC holds a 100 per cent interest in the three Weltevreden Prospecting Rights comprising the Resource area. The farm properties and mineral rights, which comprise the Weltevreden Coal Resource area and its related legal tenure are summarised in Figure 6.1, Table 4.4 and Appendix B.

SAEC has lodged a Section 102 amendment with the DMR to include the opencast mining of defined Coal Resources within the Weltevreden Prospecting Rights within the Klipspruit Mining Right (Ref No. MP30/5/1/2/2/125MR). This is expected to be completed in 2014/15.

Figure 6.1: Summary of ownership and tenure for Weltevreden

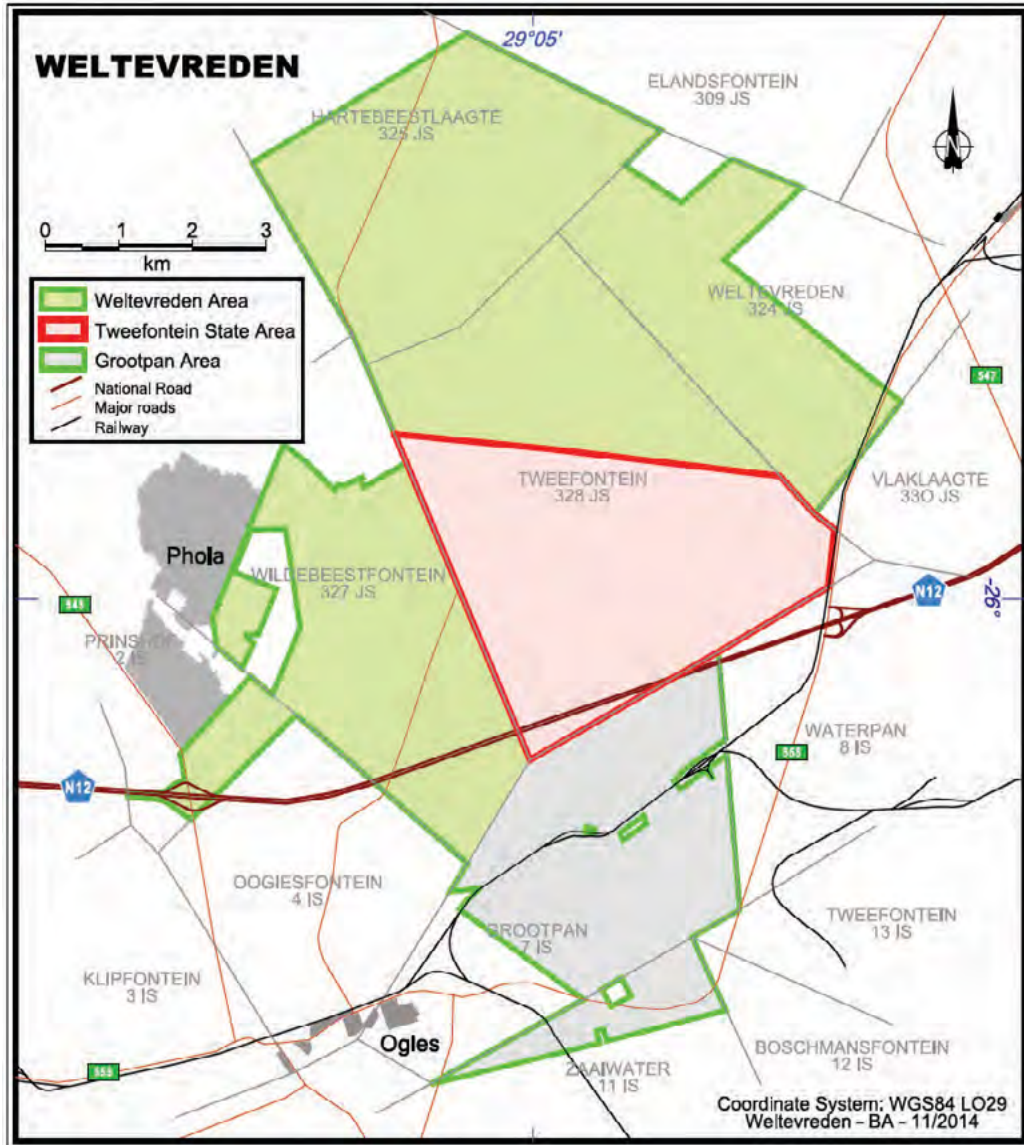

Source: SAEC

6.2.4 History

Intermittent exploration drilling at Weltevreden has been ongoing since the 1990s, with 273 boreholes completed since 2002. To date, a total of 467 boreholes have been used for

geological modelling and Coal Resource estimation purposes. The borehole distribution is shown in Figure 6.2.

Figure 6.2: Weltevreden borehole plan

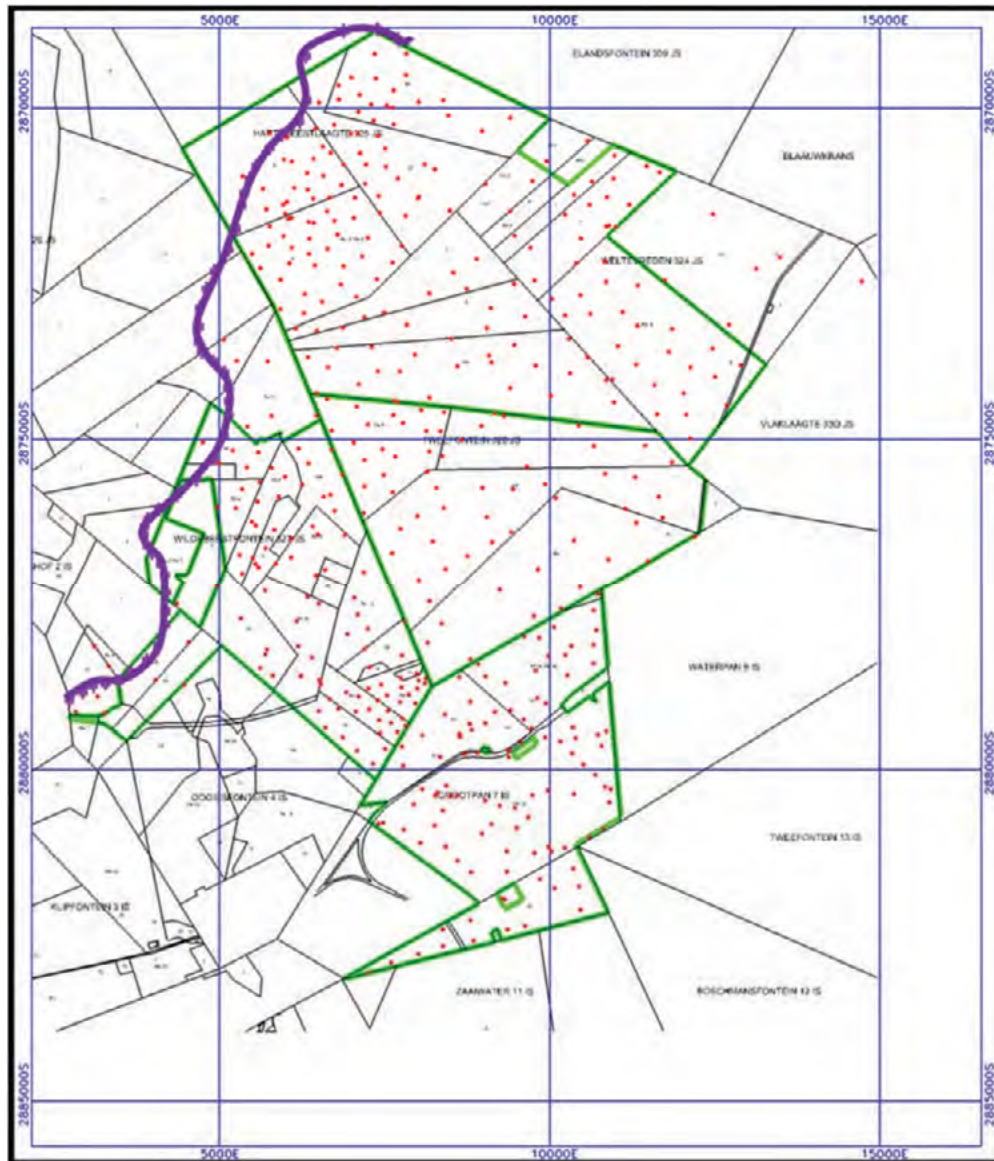

Source: SAEC

No previous mining has taken place at Weltevreden Coal Resource area.

6.2.5 Local geology

The Resource area contains several coal seams suitable for opencast mining, and while the project may be viewed as an extension to Klipspruit Mine, the resources are separated by a basement palaeo-ridge.

The main coal seams are typical of the Witbank Coalfield (refer Figure 5.4). The thickest and most extensively developed comprise the No.2 and No.4 Seams. No major structural dislocations of the seams have been identified, and there appears to be no significant dolerite intrusions in the area.

Seam floor rolls have been modelled and shown in cross-sections in Figure 6.3 and can result in floor gradients locally exceeding 10 per cent. Fluvial channel deposits and seam washouts are also known to occur and are difficult to predict from drilling.

Figure 6.3: Weltevreden cross-section

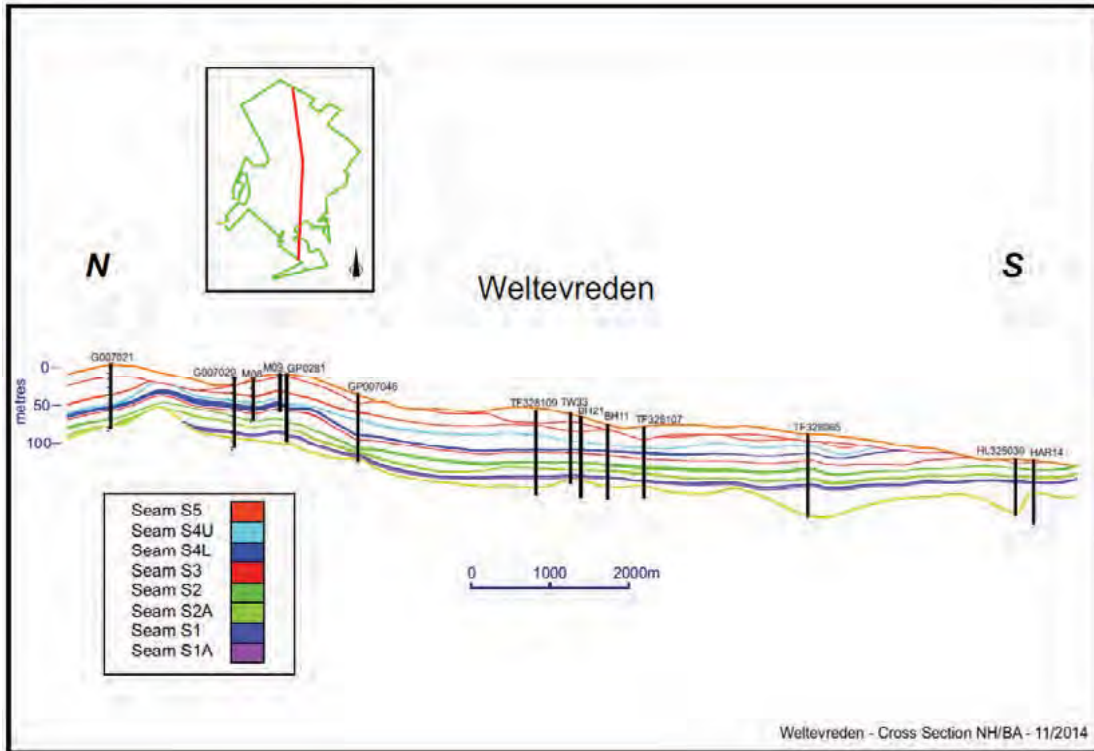

Source: SAEC

6.2.6 Coal Resources

The Weltevreden Coal Resources as at 30 June 2014 are presented in Table 4.7 at a seam thickness cut-off of 0.8 m. Table 6.1 presents the total Coal Resources on a seam basis. Three seams, which are all in excess of two metres thick namely, the No.4L, No.2 and No.2A Seams, contribute most of the tonnes. The high ash nature of the No.2 Seam is due mainly to the presence of in-seam partings.

Table 6.1: Weltevreden Coal Resources on a seam basis as at 30 June 2014 (adb)

Seam	Resources (Mt)	Avg Thickness (m)	Avg Ash (%)
No.5	24	1.5	33.1
No.4U	31	1.6	33.2
No.4L	153	3.1	30.9
No.2	116	2.6	37.3
No.2A	155	2.4	26.8
No.1	68	1.5	22.5
Total	547		30.3

Source: SAEC

6.2.7 Mining

Introduction

Having carried out an Identification Phase Study (“IPS”) for KPSX in 2013 and 2014, SAEC has outlined a number of pits based on development of the Weltevreden Coal Resource and Klipspruit South areas (Figure 6.4). Under the development scenarios, Klipspruit’s mine life may be extended by approximately 50 years.

Figure 6.4: Plan showing proposed LOA mining pits



Source: SAEC

SAEC’s LOA production schedule for the KPSX was updated by SAEC in 2014. Figure 6.5 and Figure 6.6 summarises the anticipated ROM and saleable tonne production schedule under the current LOA plan.

Figure 6.5: Forecast ROM Production Schedule for LOA Plan

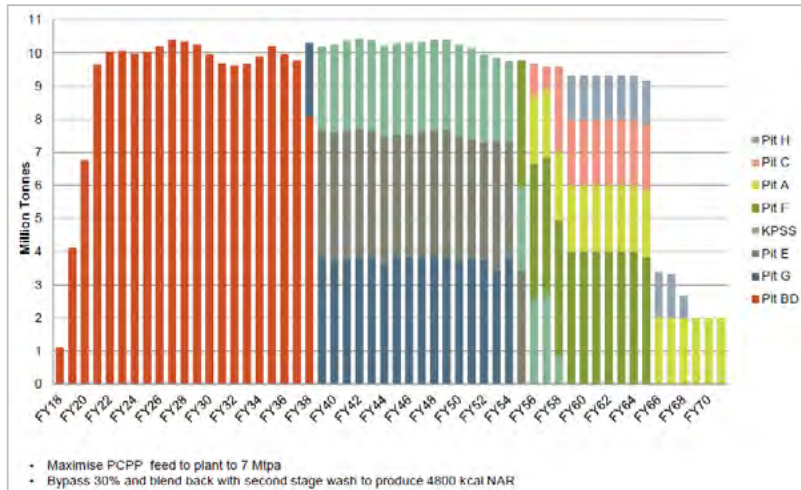

Source: SAEC

Figure 6.6: Forecast Export Saleable Coal Production for LOA Plan

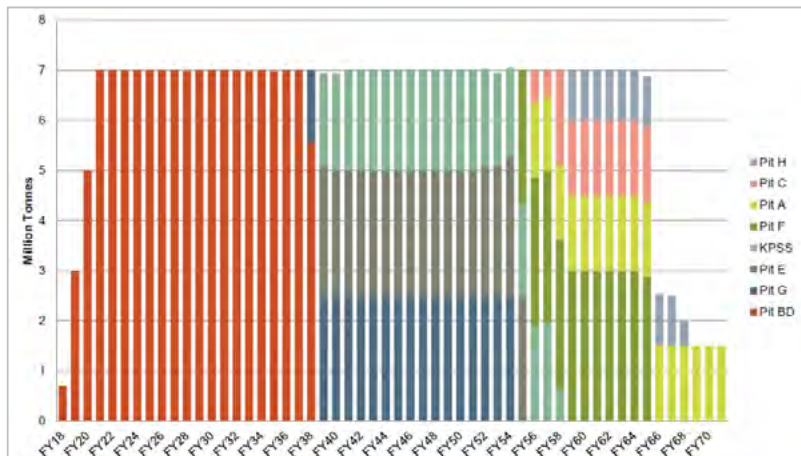

Source: SAEC

The proposed LOA schedule includes Inferred Coal Resources and a small portion of unclassified blocks, in addition to the Coal Inventory blocks. The inclusion of this Inferred and unclassified material in the LOA plan results from some of these blocks having to be mined in order to access adjacent coal blocks. SAEC has included a provision for an exploration programme aimed at upgrading the currently defined Inferred Coal Resource blocks informing the first 10 to 15 years of production under the LOA plan.

“Go forward” Case

SAEC has prioritised a preferred “go forward” case, which comprises the development of the B and D pits within the Weltevreden Coal Resource area only (Figure 6.4).

SAEC is currently conducting a pre-feasibility study into the opencast mining potential of the “go forward” case. Detailed mine planning, processing and costings are currently being undertaken as it is SAEC’s intention to convert the defined Coal Resources within B and D pits to Coal Reserves in the near term.

The “go forward” case comprises opencast strip mining of No.1, No.2 and No.4 Seams at B and D pits. Strip mining will utilise a dragline with truck and shovel methods. It is expected that box cuts will be created with mining progressing down dip to the east and haul roads providing access to the mined areas by means of a ramp. Under current plans, the boxcut is expected to start in Pit D and progress in later years to Pit B. This is planned to be an owner operator mine.

To access the opencast coal, topsoil must be stripped by truck and Komatsu PC 8000 (equivalent) shovel operation and stored for later rehabilitation. Overburden and interburden stripping is then planned to be performed by dragline (ex Klipspruit) and truck and shovel fleets. Separate coaling fleets will transport the coal from the pit to a RoM stockpile.

Opencast strips and blocks will be similar to those at Klipspruit Mine with a strike length varying from 1 km to 3.3 km and a strip width of between 50 and 60 m.

Overburden access is provided by high wall ramps and terminating with one or two wall end ramps depending on the pit configuration.

The current mine design includes a single opencast, which is planned to produce approximately 10 Mtpa ROM or 7 Mt saleable (Figure 6.7 and Figure 6.8). The “go forward” case is expected to last at least 20 years. The opencast layout has been designed to mine with an average strip ratio between 4 and 7 bcm/t ROM.

The “go forward” case is well located to continue to supply the export coal required to maintain SAEC’s current export volume profile, with the ROM coal to be processed at the existing Phola Coal Processing Plant Joint Venture.

Figure 6.7: Forecast ROM Production Schedule for “Go forward” Case

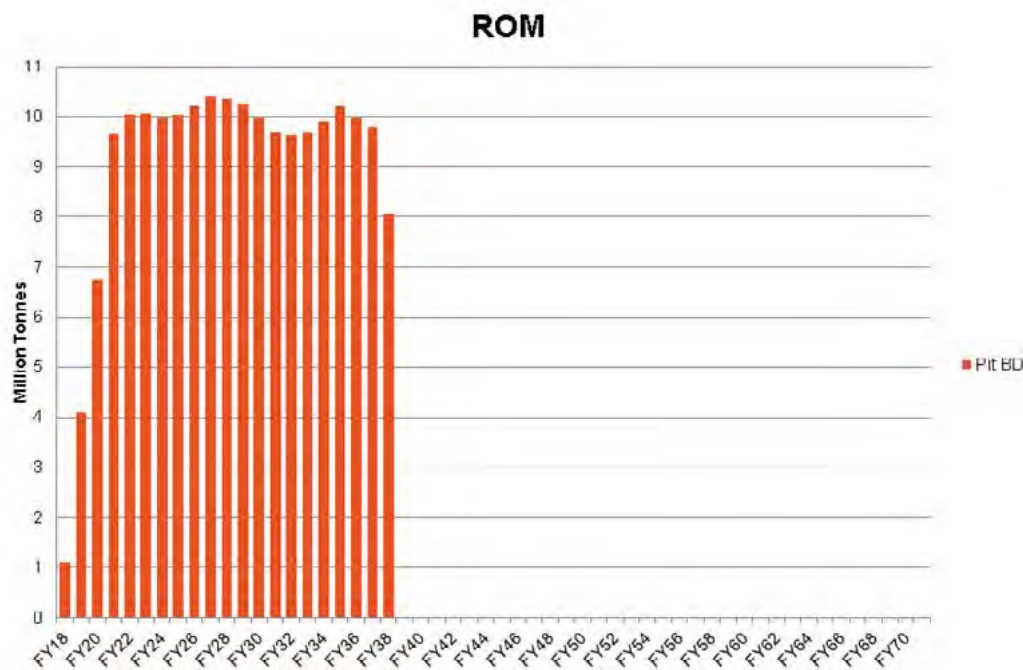

Source:SAEC

Figure 6.8: Forecast Export Saleable Coal Production for "Go forward" Case

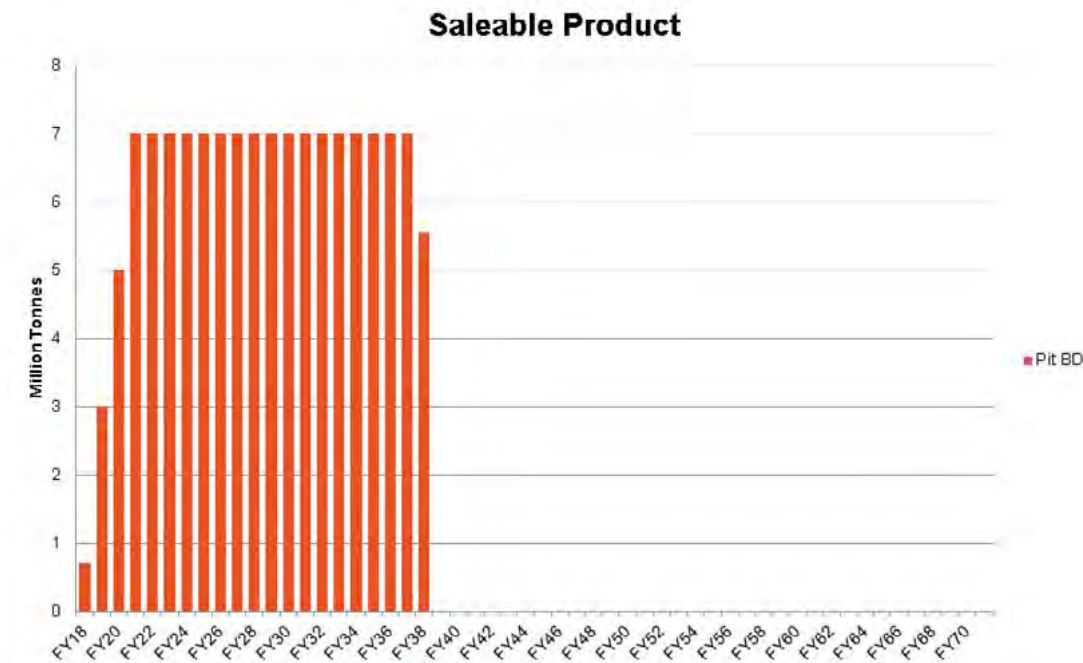

Source: SAEC

Proposed infrastructure

The final location of infrastructure has not yet been formalised and will be investigated during the EIA Phase. Currently proposed infrastructure associated with KPSX includes:

- Opencast pit including ramps and box cuts;
- Haul roads;
- Overburden and topsoil stockpiles;
- Clean water cut off canals;
- ROM stockpiles;
- Workshops and mobile offices; and
- Electricity supply to workshops and shovel.

The final locations of the opencast pits are currently being investigated and their locations await further environmental studies. Under current proposals, the box cut location for the different pits will be optimised for each pit locations. The topsoil stockpile (42 ha) will be situated between the opencast pit and the western border of the mining area, adjacent to Phola township. Discard dumps will be located adjacent to each of the opencast pits.

Under current plans, the ROM coal will be transported from the opencast pit to a buffer stockpile before being transported to the Phola Plant at Klipspruit Mine.

No decision has been finalised as to the preferred coal hauling options from the new mine to the Phola CHPP.

6.2.8 Environmental aspects

Wetlands

Xstract notes that in the current LOA plan, SAEC has included all parts of the defined Coal Resources residing within wetlands, on the assumption that mining (Figure 6.9 and Section

6.2.7) is practically achievable. However, in Xstract's opinion there is considerable risk involved with this assumption, as portions of some pits may not be able to be mined on environmental grounds. This could result in a discount to the current Coal Resource estimate, but should not be material to the 20-year "go-forward case" as evaluated under the overall KPSX Project, nor does it impact the valuation of the current SAEC Coal Reserves.

Figure 6.9: Plan showing wetland areas and classification



Source: SAEC

Technical studies completed by SAEC at KPSX to date have only included limited consideration of wetland areas and their likely impact for resource estimation and mine planning purposes.

Given the current studies are at a pre-feasibility level, the exclusion of any buffer zones around wetland areas is considered optimistic. Xstract recommends such environmental factors are fully evaluated during the conversion of the defined Coal Resources to Coal Reserves and Feasibility level studies prior to development. Permission to mine through wetlands, or within this buffer zone, is an arduous process, and success is not guaranteed.

Wetlands are increasingly becoming a contentious issue not only in terms of mining permissions but also in terms of prospecting drilling, especially within new project areas. Special permission is required from the DWS for drilling within 500 m of a wetland area and this measure will have a serious impact on the effective execution of future exploration programmes. SAEC acknowledges the risk.

It should however be noted that the majority of identified wetland areas are of low sensitivity status, with few pristine areas, having been significantly degraded by historical farming/cropping activities. SAEC expects to work closely with the relevant Government Departments in relation to the management of these wetlands in the context of the KPSX Project, and believes the Weltevreden Coal Resources have reasonable prospects for eventual economic extraction.

Environmental permitting

A Section 102 Amendment application in terms of the MPRDA will be required to include KPSX into the existing Klipspruit Mining Right authorisation. This is expected to be a lengthy process, as there is no legislative time frame to which the DMR is compelled to adhere. There is a risk of delays in obtaining authorisation from the DMR. These risks are noted in SAEC's project risk register.

6.2.9 Risks and opportunities

Risks at KPSX have been identified as:

- Generally higher strip ratio and lower yield than current Klipspruit Mine.
- Timing of Prospecting Rights renewal impacts on SAEC's ability to carry out feasibility study exploration.
- A Section 102 Amendment application will be required to include the Weltevreden Prospecting Rights into the existing Klipspruit Mining Right authorisation; this is expected to be a lengthy process.
- There is a risk of delays in obtaining authorisations in terms of a WUL from the DWS and further authorisations from MDEDET (as the applications were submitted prior to NEMLA coming into place).
- Potential impact of wetlands on current mine plans requires further study and clarification.

Opportunities include:

- Consideration should be given to mining of seams less than 0.8 m in thickness and to selective mining. Such a scenario may enable an increase in defined Coal Resources and provide opportunities to reduce ROM ash contents.
- Synergies exist with adjacent operations including SAEC's Klipspruit Mine.

6.3 Leandra (North and South)

The Leandra Project straddles the Gauteng-Mpumalanga Provincial boundary approximately 100 km southeast of Johannesburg. The town of Delmas lies some 25 km to the northwest of the project.

The project is divided into two halves designated Leandra North (centred at latitude 26°17'36" South, 28°47'09" East, elevation 1,620 m) and Leandra South (centred at latitude 26°31'09" South, 28°54'01" East, elevation 1,620 m). Access to the site is provided by the N17 national highway and a network of provincial roads.

6.3.1 Land tenure

The ownership, farm properties, surface rights and mineral rights, which comprise the Leandra (North and South) Projects and their related legal tenure are summarised in Figure 6.10, Table 4.4 and Appendix B.

Figure 6.10: Summary of ownership and tenure for Leandra

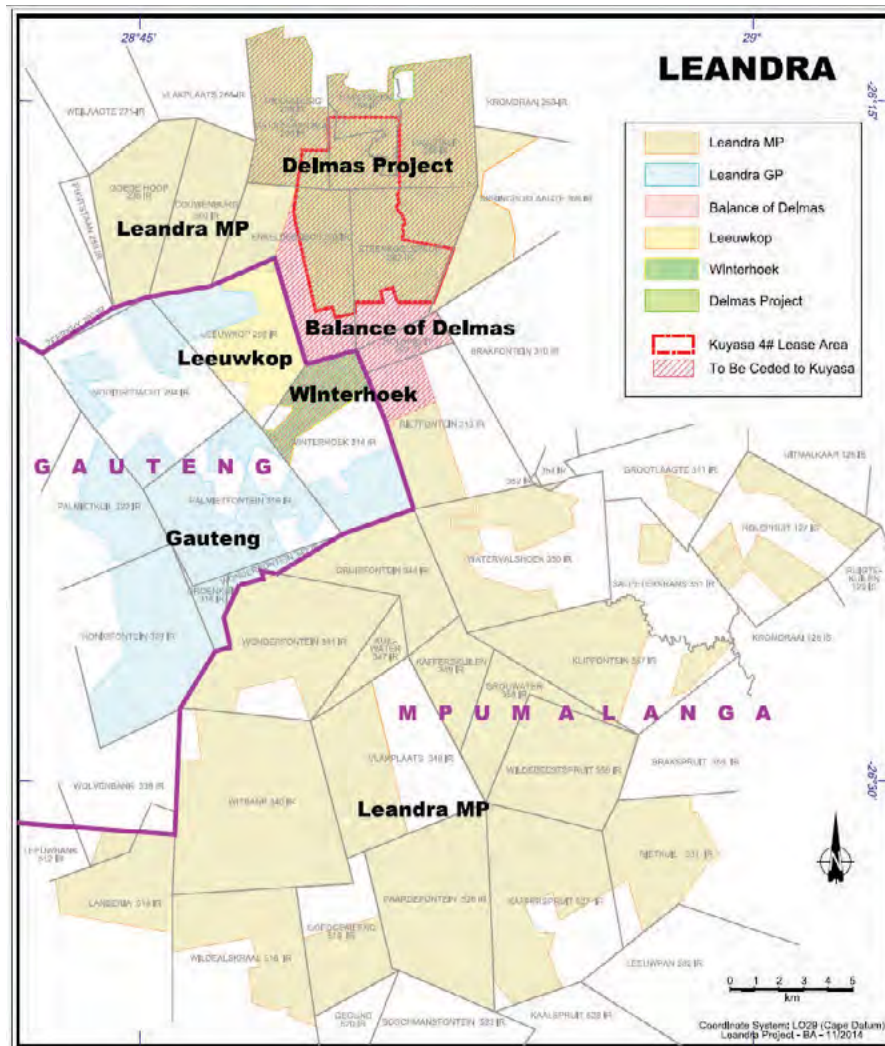

Source: SAEC

6.3.2 History

A total of 1,178 boreholes have been completed within and adjacent to the Leandra North and South Project areas, and are available for geological modelling.

6.3.3 Local geology

The Leandra Coal Resources are located in the northwestern part of the Highveld Coalfield and adjacent to the former Delmas Mine. The coal-bearing strata are hosted within the Vryheid Formation of the Ecca Group, comprising alternating sandstone and shale units. A prominent north-south trending ridge comprised of pre-Karoo basement rocks defines the western limit of coal deposition. The coal seams dip gently (approximately 1°) to the southeast. Along the western margin, the dips steepen against the palaeo-ridge.

The seams identified include the No.5 Seam, No.4UA Seam, No.4U Seam, No.4L Seam, No.3 Seam, No.2 Seam and No.1 Seam. Seam 4 Lower (No.4L) and Seam 2, especially the lower (or Select, No.2S Seam) part of the No.2 Seam, are the two main underground targets at Leandra.

The No.4L Seam is located on average 110 m below the surface at Leandra North and slightly deeper at Leandra South (average 160 m to a maximum of 240 m). The seam thickness ranges from absent up to 5.6 m, and averages 2.7 m at Leandra North and 2.2 m at Leandra South. The floor to the No.4L Seam is comprised mainly of a carbonaceous shale unit, with a sandstone floor being present only in localised areas.

The No.2 Seam is well developed across the area and is generally occurs 25 m to 30 m below the No.4L Seam. Where it abuts the basement ridge in the western part of the Leandra, the seam thins until it terminates. On average the No.2 Seam is 4.3 m thick, but varies between 0.2 and 9.1 m in thickness across the project area. Only the lower select portion (less than 45 per cent ash) of the seam was included in Coal Resources. At Leandra, the thickness of the No.2S Seam varies from 0 to 5.4 m, and thins from an average thickness of 3.1 m at Leandra North to an average of 1.8 m at Leandra South. The No.2S Seam has an average raw calorific value (ADB) of 20.7 MJ/kg to 21.3 MJ/kg.

A dolerite sill, named the B4 sill, overlies almost the entire Leandra area. It ranges in thickness up to 56 m, averaging 20 m, and frequently splits into thinner sills. It typically lies some 80 m above the No.4L seam but also transgresses the strata and uplifts the coal seams and sediments in area that are affected.

It is difficult to identify underlying dykes and faults as the B4 sill masks their aeromagnetic signature. As a result, no dolerite dykes have been mapped within the Leandra Project, although they certainly exist. However coal mining of the No.2 Seam at Delmas Mine and No.4L Seam operations at Kuyasa Mining, indicate several dykes and water-bearing faults extend into the Leandra North area. These dykes are generally 1 m to 2 m in thickness.

The north-south cross-section shown in Figure 6.11 illustrates the main structural features of the Leandra Project.

The Leandra Coal Resources occur some 160 m below surface and are proposed to be mined by underground methods. It is unlikely that there will be any impact on wetlands or surface aquifers in the area.

Figure 6.11: Cross-section through Leandra Project

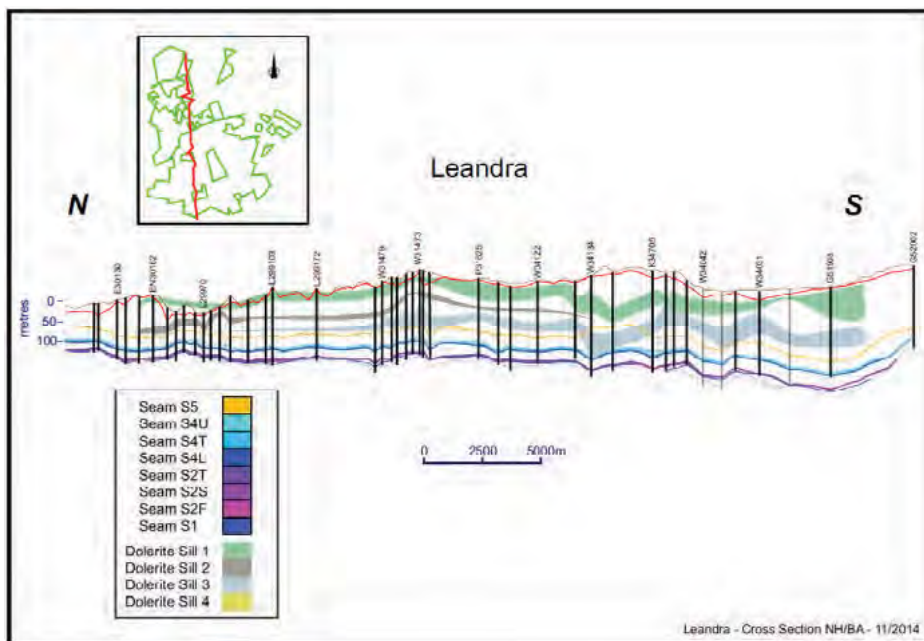

Source: SAEC

6.3.4 Coal Resources

The Leandra Coal Resources as at 30 June 2014 are presented in Table 4.7. The Coal Resource, assumed to be extracted by underground mining methods, is primarily suited for the thermal coal market supplying either power generation or petro-chemical markets, with limited potential for superior washed products. A 1.8 m thickness cut-off was applied, along with a 10 per cent geological loss factor at Leandra North and 15 per cent at Leandra South.

Figure 6.12 shows the Coal Resource footprint at Leandra, as well as the locations of major dolerite sill transgression of the No.4L Seam.

Figure 6.12: Leandra (North and South) Coal Resource footprint

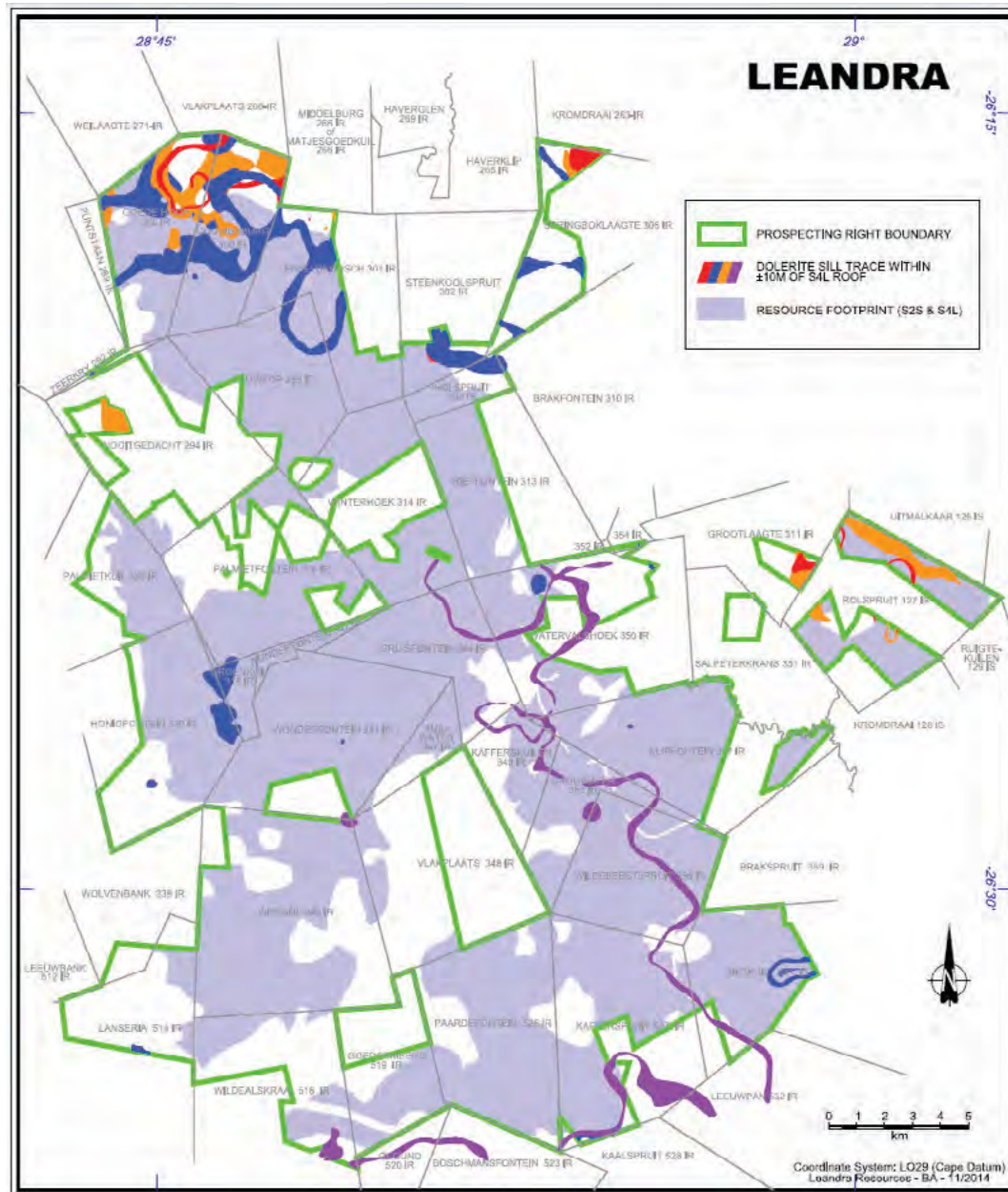

Source: SAEC

On a seam basis, approximately 60 per cent of the total resource at Leandra North is contained in the No.4L Seam (Table 6.2). At Leandra South, 33 per cent of the Coal Resource is contained in the No.2S Seam.

It is expected that, with further drilling and techno-economic studies, "Go Forward" areas will be identified with greater levels of geological confidence, but the currently stated Coal Resources will materially decrease in overall tonnage as less favourable geologically complex areas are excluded.

Table 6.2: Leandra Coal Resources on a Seam Basis (adb)

	Seam	Resources Total (Mt)	Thick (m)	Depth (m)	Ash (%)	CV (MJ/kg)
Leandra North	No.4L	311 (20% Inferred)	2.7	108	27.8	20.8
	No.2S	196 (20% Inferred)	2.4	140	26.7	21.4
	Subtotal	507 (20% Inferred)			27.4	21.1
Leandra South	No.4L	728 (89% Inferred)	2.6	157	26.9	20.8
	No.2S	352 (86% inferred)	2.7	201	24.7	21.7
	Subtotal	1,080 (88% Inferred)			26.2	21.0
	TOTAL	1,587 (69% Inferred)				

Source: SAEC

6.3.5 Previous technical studies

No historical mining technical studies have been completed for the Leandra North or Leandra South Projects.

SAEC is very aware of the short time frame (approximately four years) available in which they would be required to proceed to a development scenario in order to retain tenure. To this end, the Leandra (North and South) group of five Prospecting Rights (the "Project"), has been analysed through an initial study process for major capital investments.

The Project has undergone an internal phase of study which is nearing completion, where the primary outcome is an optimized view of the opportunity. A series of options analysis, trade-off studies, and evaluation has determined the preferred development option for the area in question. Included in the study are assessments of the geology, potential mining methodology, processing, marketing, risk, health and safety, environment, and community, culminating in a financial and risk based conclusion which identifies a preferred development option, referred to as the Go Forward Case (GFC).

During this process the SAEC staff at the owned and operated Khutala underground mine were widely consulted for their views and input to the Project. Also reviewed as part of the project study were the existing underground mines of two competitor operations mining on the north east and south east boundaries of the Project area. By conducting underground site visits and meeting with the technical staff of these operations, the Project team was able to gather valuable knowledge regarding the mining conditions that could be expected, potential solutions to difficult conditions, productivity, cost, and market data, and activities to prioritise during further study in order to minimize the risks and impacts to SAEC's development choices.

Drilling in the "Go Forward" area of an additional planned 128 boreholes is under way, of which 42 boreholes have been complete, and a further 86 boreholes are expected to be complete by July 2015, with the deployment of additional drill rigs to the area, which will soon total nine rigs.

The additional drilling currently ongoing within the Leandra Mpumalanga Prospecting Right, will allow the "Go Forward" area to be classified at approximately 70% Indicated by the end of the drilling. Further geophysical work incorporating aeromagnetic and seismic surveys is also planned to enhance the understanding and confidence in subsurface structures that could impact development and mining decisions.

The Leandra Coal Resources, on a raw coal basis, are suitable for domestic power generation and possible synfuel production. Some areas may be suitable for a 4,800 kcal/kg NAR product to supply international or local markets.

A Mining Right application shall be lodged with the DMR prior to the expiry of the Leandra Mpumalanga and Leandra Balance of Delmas Prospecting Rights in September 2015. Granting of the Mining Right will secure tenure over all five Prospecting Right areas. Currently the renewed Leandra Leeuwkop and Leandra Gauteng prospecting rights have not yet commenced, which once they do, will allow for a further three years of prospecting. Until the renewed Leandra Leeuwkop and Leandra Gauteng prospecting rights are notarially executed, or the Mining Right application has been granted, no further drilling can be undertaken thereon.

The approved prospecting work programmes for all Prospecting Rights have been met to date, and all other conditions of the Prospecting Rights have been met. Addendums submitted to the DMR for additional drilling are currently being fulfilled, and SAEC is confident that the Mining Right application for the Leandra Project will be submitted to DMR in the prescribed time. Every effort and resource has been allocated to achieve the drilling status required and other requirements for the Mining Right application to be submitted timeously, i.e. prior to the expiry of the Prospecting Rights. The SAEC Competent Person believes the Leandra North and South Coal Resources have reasonable prospects for eventual economic extraction.

6.3.6 Risks and opportunities

Risks at Leandra include:

- The relatively immature exploration status of the Leandra South Project exacerbates the time constraints associated with conversion of the current Prospecting Rights to Mining Rights.
- Given the above time constraints and recognising that prevailing market conditions may not warrant development in the near future, it is possible that SAEC could stand to lose tenure over these Prospecting Rights if they are unable to submit a Mining Right application and development plan in the required time frame.
- The structural complexity observed at adjacent third-party owned and operated mines indicates that the currently applied geological losses are insufficient to account for likely losses.

Opportunities at Leandra include:

- An opportunity exists to increase the currently defined Coal Resource base of the No.2S Seam if the thickness cut-off is reduced from 1.8 m to 1.5 m.
- With prudent planning, there is no reason why there would be any major environmental or social impact effect on the Leandra project.

6.4 Naudesbank

The Naudesbank Project is centred at latitude 26°07'12" South, 29°56' 02" East. The Project lies some 10 km west of the town of Carolina within the Mpumalanga Province, and approximately 210 km east of Johannesburg.

Access is achieved from the R38 and R36 provincial roads, while the Ermelo-Carolina branch rail line, with connections to the Richards Bay Rail Line, lies some 4 km to the southeast of the project.

The terrain is typical of the Highveld region with low undulating relief and slightly incised topography. Elevations across the area range from 1,600 m to 1,725 m above sea level. A number of small tributaries to the northeast draining Komati River are evident throughout the area. Wetland areas are abundant over the project area. Carolina is a mixed farming community.

6.4.1 Land tenure

The ownership, farm properties, surface rights and mineral rights, which comprise the Naudesbank project and its related legal tenure are summarised in Figure 6.13, Table 4.4 and Appendix B. The Prospecting Rights are sufficient for exploration of the area but negotiations are required with surface owners for any future drilling operations.

Figure 6.13: Summary of Naudesbank tenure showing resource footprint and wetland buffer

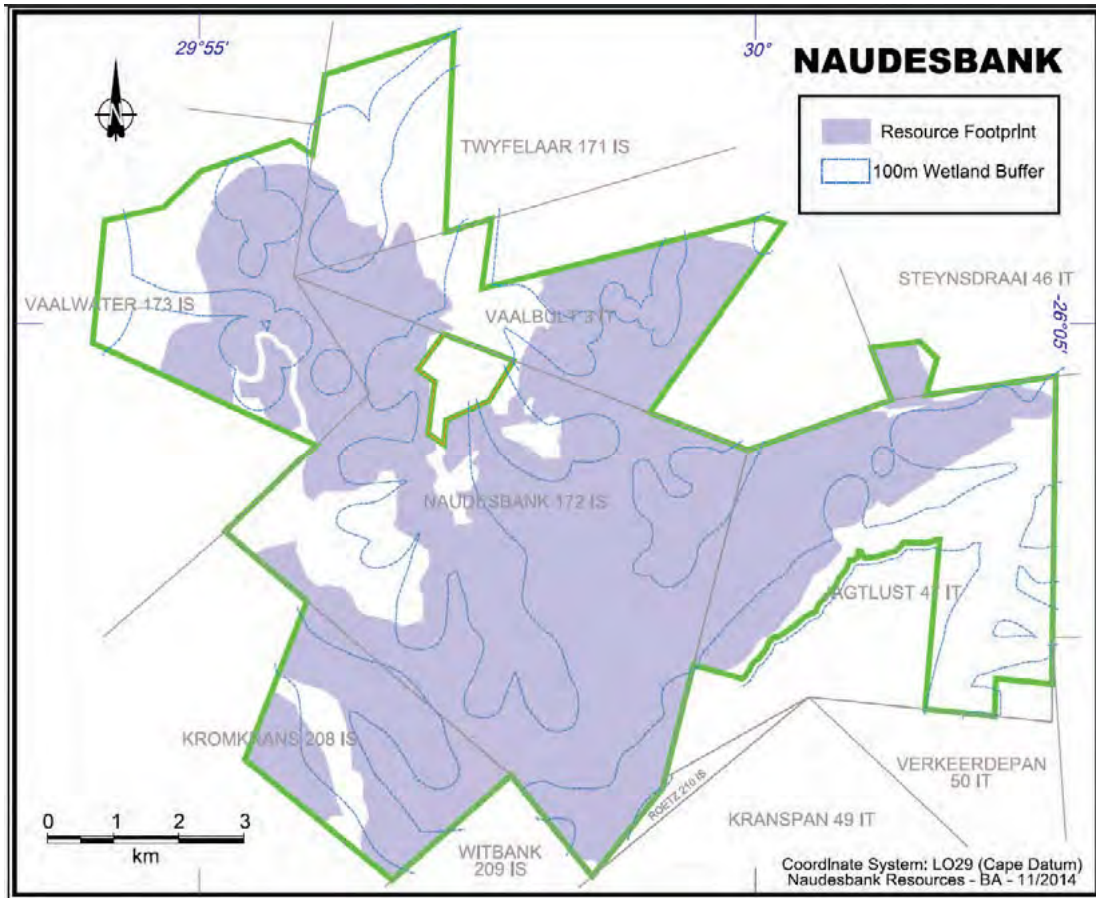

Source: SAEC

6.4.2 History

Exploration drilling has been carried out over the Naudesbank area since the mid-1940s, with most exploration boreholes being fully cored to the basal coal seam, a maximum depth of 125 m. Most recently, a total of 63 boreholes were drilled at Naudesbank during the period 2006 to 2009. A total of 374 boreholes are available for geological modelling.

6.4.3 Local geology

The Naudesbank Project lies towards the northern limit of the Ermelo Coalfield, hosted by the coal-bearing Vryheid Formation of the Ecca Group. Five coal seams are present and are named from the dominant E Seam at the base to the A Seam at the top of the succession (Figure 6.14). The A Seam is further split into the A Upper ("AU") and A Lower ("AL") Seams, while the C Seam is divided into the C upper ("CU"), C Middle ("CM") and C Lower ("CL") Seams.

Figure 6.14: Cross Section through the Naudesbank Project

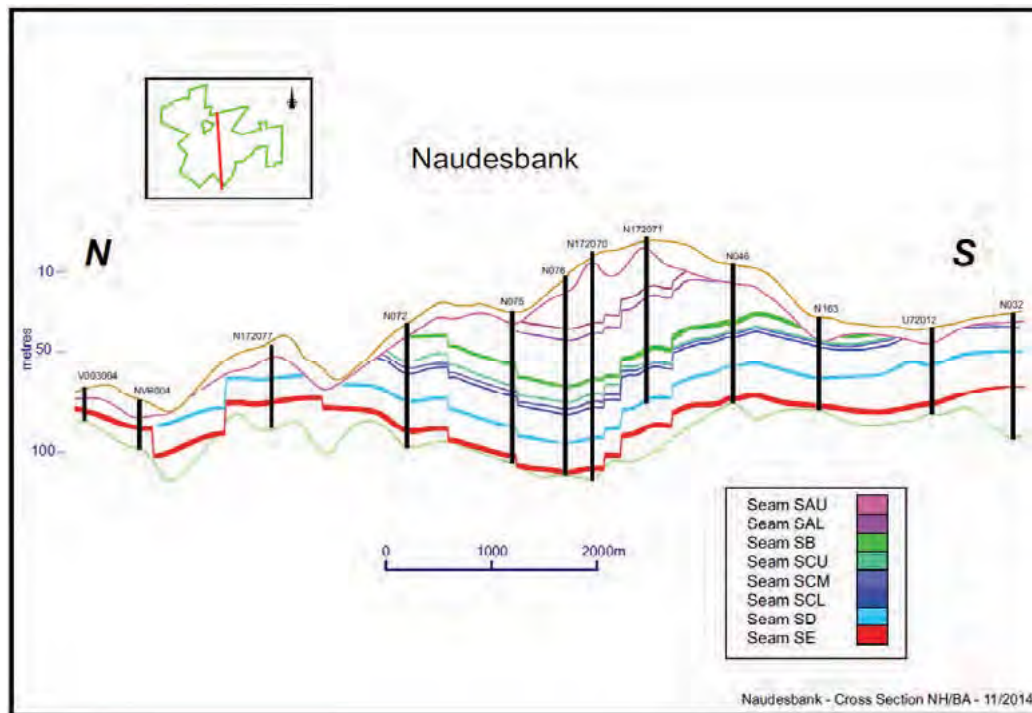

Source: SAEC

The basal E Seam is developed across 60 per cent of the Prospecting Right and ranges in depth from sub-outcrop to 110 m below surface, averaging 40 m. It averages 1.6 m in thickness and gradually thins towards the southwest of the property with associated deterioration in coal quality.

The lateral continuity of seams is affected by both the undulating base of weathering surface, which broadly follows the topography, and faulting usually associated with dolerite sill transgressions. The upper most AU Seam is only present across 2 per cent of the area, as a result of the above two factors.

Structurally, the seams are flat lying with a gentle dip to the south-west. Faulting occurs with increasing frequency to the south. Faults are almost without exception invaded by dolerite intrusions. Dykes are common in this field, while sills appear to be more numerous towards the south.

6.4.4 Coal Resources

The Naudesbank Coal Resources as at 30 June 2014 are presented in Table 4.7. It is assumed that the deposit will be mined by opencast methods. A seam thickness cut-off of 0.5 m was applied, along with a geological loss factor of 10 per cent.

On a seam basis, the Naudesbank Coal Resources are dominated by the thicker and most continuous E Seam (52 per cent of the total Resource) (Table 6.3). Strip ratios for the Coal Resource are acknowledged as being high (7:1 to 10:1 in-situ bcm/t) and are further exacerbated if either; seams of less than 0.8 m in thickness are excluded, or the CM Seam is excluded due to its high inherent ash. Table 6.3 also shows an indicative average theoretical yield per seam for a 26.8 MJ/kg coal product.

Table 6.3: Resources for Naudesbank Project on a seam basis (adb)

Seam	Resources Total Mt	Thick (m)	Depth (m)	Ash (%)	CV (MJ/kg)	Avg. Yield (%) (26.8 MJ/kg)
SAU	2	0.87	22	19.1	25.8	91
SB	48	2.08	23	34.4	19.9	34
SCU	17	0.69	28	35.0	19.5	37
SCM	21	0.95	29	38.6	17.8	12
SCL	20	0.77	28	19.7	25.4	90
SD	45	0.77	35	25.5	23.2	74
SE	135	1.68	40	19.2	25.7	89
TOTAL	289			25.2	23.4	70

Source: SAEC

6.4.5 Risks and opportunities

Risks at Naudesbank include:

- There is significant wetland coverage overlying the Naudesbank Coal Resource footprint. Wetlands are increasingly becoming an issue not only in terms of mining permissions but also in terms of exploration drilling especially within new project areas. Special permission is required from the Department of Water Affairs for drilling within 500 m of a wetland area and this measure will have a significant impact on the effective execution of future exploration programmes.
- The coal seams at Naudesbank in the Ermelo Coalfield, and are typically thinner than those in the Witbank Coalfield. The cumulative impact of loss and dilution on the Naudesbank coal seams remains to be quantified.

Opportunities include:

- Potential to mine thinner seams should be investigated to increase the currently defined Coal Resources and to facilitate selective mining.
- Opportunity exists to investigate underground mining in the E Seam. Such an extraction scenario would relieve pressure on surface wetlands.

7 Exploration assets

In addition to the Mining and Development Assets, SAEC hold a number of other Exploration Assets in the Witbank, Highveld, Ermelo and Waterberg Coalfields. Xstrat does not consider these regional exploration assets to be material in terms of the overall value assigned to SAEC, however they are important as they provide further growth options going forward and hence are summarised briefly here for completeness.

This section evaluates the assets at the level of technical information available. At the time of publication, these exploration assets are either: (i) small and isolated coals unlikely to

be of sufficient scale to attract further investment from SAEC in the near term, (ii) located in close proximity to formal settlements and hence may prove difficult to obtain the necessary approvals for development and/or (iii) did not meet the criteria for the classification of Mineral Resources according to the JORC Code.

As such, these assets are considered to represent long-term projects, which are not currently planned or expected to be further tested or developed in a period of less than five years.

Based on its review of the technical data supplied, Xstract notes the following with respect to these Exploration Assets:

- The Union Project comprises two granted Prospecting Rights, located immediately south of SAEC's Naudesbank Project and hence has similar geology and development history to Naudesbank. Further studies and approval to explore and mine in the area's extensive wetlands would be required before a Coal Resource could be reported from the existing exploration data.
- The Pegasus Project consists of a single Prospecting Right and associated Mining Right application located on some 13 km north of Witbank in the northern part Witbank Coalfield and adjacent to Evraz Plc's Highveld Steel and Vanadium ferroalloy plant. Pegasus is a mature exploration project on shallow, low ash, export-quality thermal coals in the No.1 and No.2 Seams. The deposit has been the subject of intermittent but extensive drilling since the mid-1970s and Xstract expects the existing information will be sufficient to estimate and report a small Coal Resource.
- The Witbank South Project comprises a single Prospecting Permit subject to conversion to a New Order Prospecting Right, which immediately abuts the southeastern quadrant of Witbank's residential area. The permit area has an extended mining history and the majority of the area is underlain by underground workings of the now defunct South Witbank Mine, largely in the No.2 Seam. Recent work has shown there is potential for modest tonnages at South Witbank in the No.2 Seam and remnant underground pillars, however further studies will be required to delineate and report a Coal Resource for the area.
- The Waterberg Project comprises a single Prospecting Right in the Limpopo Province and at a significant distance to SAEC's other projects. The project is divided into two separate areas situated 30 km apart. Exxaro's Grootegeluk coal mine, Eskom's 3,900 MW Matimba power station and the regional centre of Lephalale all lie to the southeast of the project area. Since 2006, SAEC has carried out drilling campaigns over the area targeting coal seams of the Permian-aged Swartrand and Grootegeluk Formations. The coals exhibit high ash and low yield characteristics and are expected to be suitable as a local steaming coal product. Despite sparse data coverage and complex structure, the existing information may be sufficient to estimate and report a Coal Resource for the area.

8 Market analysis

8.1 Macro-economic analysis

8.1.1 Introduction

Coal is a widely distributed natural resource produced in numerous countries worldwide. In 2013, the world produced some 7.89 Bt of anthracite, bituminous and sub bituminous coal. This was 0.8 per cent more than in 2012, the weakest growth since 2002 (BP, 2013). China and the US are the world's largest coal producers, with the majority of these coals consumed domestically.

Global coal consumption grew by 3 per cent in 2013, well below the ten-year average of 3.9 per cent. However, coal's share of global primary energy consumption reached 30.1 per cent, the highest since 1970. China and India remain the world's largest consumers of coal.

According to BP statistics, global proved coal reserves equate are 891.5 Bt, or 113 years of supply at current consumption rates. The US, Russia and China hold the largest proved reserve positions at 237 Bt, 157 Bt and 115 Bt, respectively. Other countries with significant reserves include India, Australia, South Africa and Indonesia.

The coal market is subdivided into thermal and metallurgical coals. Thermal coal is used to produce steam (for power generation and heating), and for industrial applications such as cement manufacture. Thermal coal is differentiated on energy content into:

- Bituminous, with specific energy of greater than 5,400 kcal/kg (gross as received - "GAR")
- Sub-bituminous, with specific energy of between 4,500 and 5,400 kcal/kg (GAR)
- Low rank, with specific energy of less than 4,500 kcal/kg (GAR)

Metallurgical coal is used in steel production, where it is used either to (i) produce coke or for pulverised coal injection ("PCI").

Only about 15 per cent of the world's coal production is exported. Seaborne trade is far more significant in terms of size and distribution, while land-borne trade is confined to a few key regions (i.e. Russia and Eastern Europe, Mongolia and China).

Due to the relative cost of shipping, the seaborne market is generally divided into two geographic regions; the Atlantic and Pacific. However, some inter market trade occurs when quality, freight and price differentials allow. South Africa sits in the enviable position of being able to access both the Atlantic and Pacific seaborne markets.

Pacific trade accounts for approximately 75 per cent of the seaborne market, with Australia and Indonesia being the largest suppliers. Traditionally, Japan, South Korea and Taiwan were the main importers of Pacific seaborne coals. However, significant demand has emerged from China, India and to a lesser extent, Southeast Asia. In the Atlantic market, South Africa, Russia and Colombia are the largest suppliers into the European market.

8.1.2 Global seaborne thermal coal

Power generation, using thermal coal, is driven by world economic activity. The slowdown in economic growth in Europe and more recently in Asia has negatively impacted on coal supply. As a result, there has been an excess of thermal coal supply in many regions of the world.

Between 2005 and 2012, seaborne thermal coal demand increased annually by an average of 8 per cent. Asia accounted for almost all of this seaborne demand growth driven by its developing economies. The demand growth has been strongest in China and India with strong, albeit less volumetrically substantial, growth in smaller developing economies in Southeast Asia.

8.1.3 Forecast thermal coal demand

Global seaborne demand is forecast to increase from 936 Mt in 2013 to 1,122 Mt in 2018 at an average annual increase of 3.7 per cent (Wood Mackenzie, 2013). Demand growth is expected to be led by China and India, which are forecast to collectively account for 85 per cent of seaborne demand growth between 2013 and 2018.

8.1.4 Forecast thermal coal supply

Seaborne exports are expected to keep pace with demand growing from 936 Mt in 2013 to 1,122 Mt in 2018 (Wood Mackenzie, 2013). Strong growth demand from Pacific markets are expected to encourage South Africa and Colombia to increase supply.

Australia is the second largest supplier of high-energy bituminous coal and is expected to increase its market share from 33 per cent in 2013 to 42 per cent in 2018. Other high-energy coal supplies from South Africa, Russia and Colombia are forecast to maintain market share. Indonesia is expected to continue to supply low energy coals.

8.1.5 South Africa

In 2013, South Africa produced 255 Mt of coal mainly from coalfields in Gauteng, Mpumalanga and Free State Provinces. South Africa's coals are generally low in sulphur but high in ash. Beneficiation is essential for export-quality coal. Lower-quality coal is primarily used for the local power generation market.

As the country's principal electricity generator and supplier, approximately 90 per cent of Eskom's electricity is sourced from coal-fired power stations, using some 125 Mt of coal annually (or approximately 49 per cent of domestic coal production). Eskom requirements are forecast to reach 140 Mt over the next five years and 150 Mt by 2022.

Sasol is also a large consumer of domestic coals, which it uses to produce synthetic fuels and chemicals. The third main consumer is the local industrial sector, which includes the iron and steel industry. These industries consume approximately 20 per cent of South Africa's annual coal production.

Coal exports are equivalent to about 32 per cent of South African output and are mainly destined for Pacific markets but also Europe. The main route for exports is through Richards Bay Coal Terminal in the province of Kwazulu-Natal, but some coal is also exported through Mozambique using the Matola Coal Terminal in Maputo.

Given planned improvements in infrastructure, exports are forecast to increase from 82 Mt in 2013 to 91 Mt in 2018 (Wood Mackenzie 2013).

8.1.6 SAEC Supply

Xstract estimates that SAEC will deliver 178 Mt of coal to Eskom over the period 2015 to 2033 (Figure 8.1). While this accounts for 41 per cent of BESCA's production over that period, the balance is destined for the export market, which amounts to 255 Mt in total.

Figure 8.1: SAEC coal supply markets

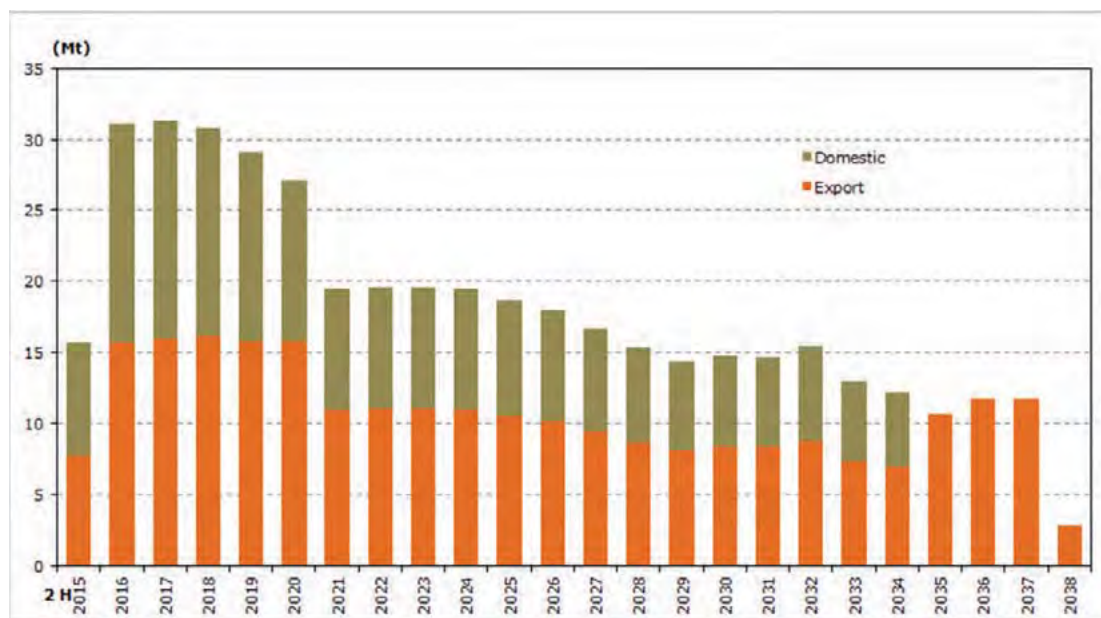

Source: Xstract estimate

8.2 Pricing

Seaborne traded thermal coal prices are reasonably transparent. In the Pacific market, price settlements between the Australian exporters and the Japanese power utilities are used to set the "Newcastle Benchmark", with a specific energy content of 6,322 kcal/kg (GAR).

Price settlements between South African exporters and consumers in the Atlantic and Pacific markets use "Richards Bay Benchmark" price with a specific energy of 6,000 kcal/g (NAR). For comparison to the Newcastle Benchmark, this is approximately 6,260 kcal/kg (GAR).

Figure 8.2 shows thermal coal prices have declined since the start of 2011 from over USD120/t to below USD80/t. Based on the preceding 20 years, the Richards Bay Benchmark has traded on average at a seven per cent discount to the Newcastle Benchmark.

Domestic coal prices to Eskom are largely based on a cost plus basis and unique between specific power stations and coal supplier. SAEC has a combination of long-term and cost-plus contracts.

Figure 8.2: Thermal Coal Price forecasts (nominal)

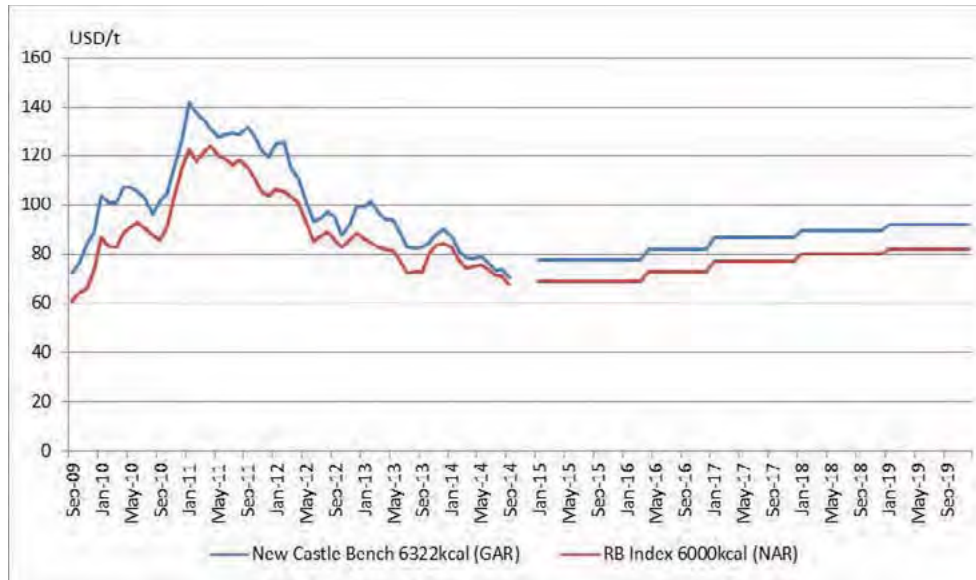

Source: Index Mundi, Consensus Economics

9 Special factors

The South African mining and minerals industry is characterised by several factors including:

- high and growing demand for power generation capacity and opportunities to export electricity to adjacent African countries
- the rising costs of labour, electricity, diesel and steel along with the resultant corporate measures to improve productivity and cut costs
- rolling brown-outs across the country as the electricity sector struggles to maintain aging infrastructure
- on-going wage demands and associated violent protests
- theft of electrical cables, pipes, etc. impacting on operating costs
- the effects of HIV/Aids on the workforce
- pressure from minority interest holders to increase equity participation in mineral and mining projects
- mineral resource nationalism
- potential limitations on export of strategic minerals
- restrictions on repatriation of profits and foreign exchange.

Xstract considers that any one, or a combination, of these factors may result in unexpected impacts on the business of SAEC.

9.1 Mine Closure Closed Mines (“MCCM”)

In addition to the mining operations discussed elsewhere in this report, SAEC manages sixteen closed mines under the guidance of the Mine Closure Closed Mines unit. This rehabilitation unit is responsible for the environmental management of the SAEC's defunct operations, based in Mpumalanga and Kwa-Zulu Natal. The following defunct operations are noted in Table 9.1.

Table 9.1: Summary of SAEC Mine Closure Closed Mines (excluding Douglas)

Mine	Areas Managed and Leased (Ha)	Disturbed (Ha)	Rehabilitated (Ha)	Undisturbed (Ha)
BLOEMENDAL	10.14	3	0	7.14
ERMELO	3218.45	16	103	3162.45
ESTANCIA (Consolidated Marshfield))	625	0	7	
GARDINIA	120	0	120	
HAASFONTEIN	6	0	6	
ROY POINT	755.83	408.51	0	
KLEINFONTEIN	151.57	0	35	
DELMARE- LEANDRA	2690	0	0	
KANGWANE ANTHRACITE	1.5	1.5	0	
MINNAAR	232	66.44	7	
WITBANK COLLIERY	1741	692	50	
TNC	1985.72	92	421	
UNION	1523.51	343	85.2	
REITSPRUIT	3667.62	99.18	1095.33	
SPEEKFONTEIN	184.84	82	60	

Source: SAEC

Bloemendal

Bloemendal Colliery is an old defunct mine situated between Paulpietersburg and Vryheid towns. Bloemendal Colliery first started production in 1964, supplying anthracite coal to local and export markets. Bloemendal Colliery consists of around 10 ha of underground board and pillar mining, with three small adits leading into the underground workings. 3 Ha disturbed by mining remains to be rehabilitated.

Ermelo

Ermelo Mines (3281.4ha), a 50/50 joint venture between SAEC and Total Exploration South Africa Ltd (TESA). The mine is situated halfway between Bethal and Ermelo in the Mpumalanga Province. The Colliery was decommissioned during 1997 and since then major rehabilitation work has been undertaken. A total of 103 Ha have been rehabilitated.

Estancia (Consolidated Marshfield)

Estancia is a defunct mine named Consolidated Marshfield Colliery and is situated approximately half way between Hendrina and Ermelo. Estancia was mined by board and pillar underground mining methods and covers an area of 625 ha. All of the rehabilitation of the disturbed areas has been completed.

Gardinia

Gardinia Colliery is situated in the Northern Kwa-Zulu Natal, approximately 15 km South West of Newcastle. Gardinia was mined by opencast mining methods. The opencast mining began in 1981 and continued to 1985, when mining operations ceased. Rehabilitation was done from 1989 to 1991 according to a rehabilitation plan approved by the Mines Department and the Landowner. No further rehabilitation work is to be undertaken.

Haarsfontein

Operations at Haarsfontein ceased in 1988 and all rehabilitation work was completed during 1992. SAEC mined No. 2 seam of Haarsfontein as a contractor to Anglo Coal. Part of the agreement was that SAEC must carry out rehabilitation work to the satisfaction of Government Engineer, and obtain Closure certificate for the mine. All the rehabilitation work was carried out and application for closure was done in 1987, and again during 1992.

Roy Point

Roypoint is situated in the Northern part of Kwa Zulu Natal province, approximately 10 km south of Newcastle and consists of 408 ha of underground and limited opencast mining, which has since been rehabilitated. The mine started in 1975 and ceased in 1992. Rehabilitation of the nine evaporation dams/surface dams is still outstanding.

Kleinfontein

Mining operations at Kleinfontein with an area of 151.57 ha ceased in 1991. Rehabilitation and aftercare of the area is completed. A draft Closure plan has been completed in line with the Minerals and Petroleum Resources Development Act 28 of 2002. The surface area above the old workings is at present being used for agriculture. Agricultural operations include cultivated maize lands and uncultivated grass fields.

Delmas Colliery

Kuyasa Coal is the current owner of Delmas Colliery and they are exploiting the # 4 coal seam. SAEC is in the process of selling the # 2 seam and Salamon shaft complex to Kuyasa.

Kangwane Anthracite

Kangwane is a bulk sample pit near Komatipoort in Mpumalanga. The pit is about 1.5 ha and the water in the pit is being used by the local community. The mine is to be rehabilitated.

Minaar

Minnaar is a defunct mine consisting of 232ha of land and is situated approximately 25km south of Witbank on the southern side of the N12 national road near the small town of Ogies. The mine has underground workings and a discard dump from which coal was sold as part of a reclamation process. The reclamation process of the dump was terminated due to poor qualities. Rehabilitation of the dump and closing of shafts and sinkholes at Minnaar was done during the 1997/98 financial year. Some areas in the future may be affected by sinkhole and subsidence formation.

Witbank Colliery

Mining at Witbank Colliery (1741 ha) area commenced in 1898. Various companies were involved with mining activities in this area. In the past, sinkholes identified over the total mining area were backfilled with surrounding material. Rehabilitation of the existing dumps was completed. Rehabilitation of the opencast void was completed during the 2009/2010 and is currently under aftercare. Some areas in the future may be affected by sinkhole and subsidence formation.

Transvaal Navigation Colliery (TNC)

TNC consists of both the underground and opencast workings with an area of 1985.72 ha. Mining operations were suspended in August 1990 and coal processing during 1994/95. All opencast areas have been rehabilitated and subsequent erosion and subsidence that took place in the opencast areas has been addressed. Some areas in the future may be affected by sinkhole and subsidence formation.

Union

Union Colliery is located 10km north-east of Breyten in Mpumalanga province with an area of 1523.51ha. Mining at Union commenced soon after 1900. Various companies were involved with mining activities in this area. The first task was to identify the responsibility of BECSA/BHP Billiton at Union. Some areas in the future may be affected by sinkhole and subsidence formation.

Reitspruit

Rietspruit Mine Services (RMS) is a 50/50 joint-venture operation with Xstrata was mainly an opencast coal mine with some underground mining taken place since the early 1990's and consists of 3667.62 ha. The mine was founded in 1976, and the South Pit was first started in August 1978. The North Pit followed in September 1981 and the Third Pit started in February 1988. Underground activities were started in 1991 and ended in December 2001. The areas which remain disturbed consist of the slurry dump and areas covered by infrastructure.

Speekfontein

Speekfontein Mine is located 22km South of Witbank on the Duvha Power Station road turnoff on the main Witbank-Bethal Road. Speekfontein comprises a small underground section and an opencast section with the total disturbed mining area being approximately 60 hectares in size. 82 Ha on the mine remains to be rehabilitated.

Douglas Colliery (Albion and Naaupoort section)

The rehabilitated areas of Douglas including Albion dump, Wolvekrans dump and Naaupoort section were handed over to MCCM in 2013. The total area of 853ha is managed under MCCM with aftercare undertaken.

A provision of ZAR1.962 Bn is in place for defunct and derelict mines and forms part of the total closure provision included in BHP Billiton's audited financial statements (Annual Report 2014). This provision is calculated as the discounted net present value of the full liabilities for all the defunct and derelict mines. It is important to note that this provision will be transferred with SAEC to South32.

9.2 Adjacent projects

SAEC's Coal Assets hold considerable market appeal, and likely strategic value, given their favourable location relative to other significant third party owned collieries and associated infrastructure, including Anglo's Zibulo and New Lago Mines, Glencore Tweefontein, Uncebo, Klippan and Middelkraal Mines, Sasol's Middelbuil Mine, and multiple power plants owned by Eskom (Figure 9.1).

Figure 9.1: Adjacent companies to SAEC’s Mining and Development Assets

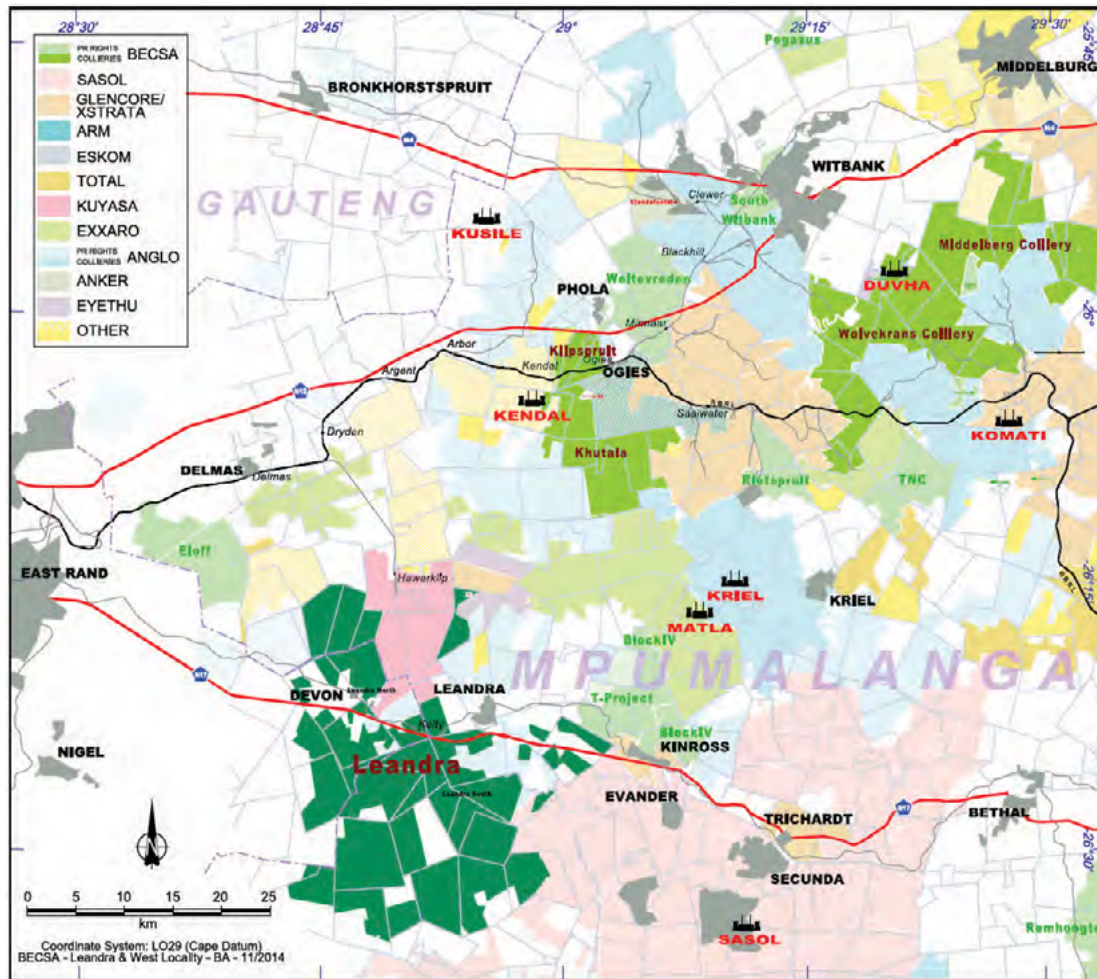

Source: SAEC

9.3 Other relevant data and information

9.3.1 Closure cost estimation – basis of estimates

Introduction

SAEC’s mines currently determine their closure costs in two ways. The first is using a format determined by the DMR for legal compliance, while the second is an internal SAEC estimate for the likely costs of closure.

Closure Liability – DMR Submission

Table 9.2 provides a summary of the estimated Closure Liability as submitted by SAEC to the DMR for FY13. The DMR Closure Liability is estimated in line with the DMR’s Guideline Document for the Evaluation of the Quantum of Closure-Related Financial Provision. Estimation of the liability is based on the areas disturbed as at 30 June 2013 with the rates determined as per the DMR guidelines adjusted for inflation.

Glencore has a 16 per cent share in the long-term water management liability at Middelburg and Wolvekrans Mines, as part of the Tavistock Joint Venture. Also at WMC,

Eskom has a share of the liability at Driefontein as part of the old Duvha mining operations.

For the DMR submission, the Eskom Liability for Khutala is included in SAEC's reporting.

The DMR submission excludes the cost for water treatment options. The submission to the DMR is based on an undiscounted cash flow model.

For SAEC's Mining Assets, the liability determined on an asset basis in compliance with the DMR guidelines, is outlined in Table 9.2.

Table 9.2: Closure Liability per mine -DMR Submission as at 30 June 2013

DMR Submission for all mines in SAEC	ZAR
Excluding VAT	3,852,183,033
SAEC Liability	3,560,282,456
Xstrata Liability	117,378,021
Eskom Liability	174,522,557
<u>By Asset</u>	
Wolvekrans Mine	
Excluding VAT	922,648,538
SAEC Liability	874,630,655
Eskom Liability	48,017,883
Middelburg Mine	
Excluding VAT	833,120,299
SAEC Liability	832,032,864
Xstrata Liability	1,087,435
Klipspruit Mine	
Excluding VAT	491,510,642
Phola Plant	
Excluding VAT	28,578,207
Khutala Mine	
Excluding VAT	156,196,997
SAEC Liability	29,692,322
Eskom Liability	126,504,674

Source: SAEC

Under current legislation, there is a requirement for a liability provision to be reflected in SAEC's financial statements in the form of a trust fund or bank guarantee. SAEC's provisions are largely covered by current funds held in trust and bank guarantees (Table 9.3).

Table 9.3: SAEC's current provisions

	(ZAR)
Total Guarantees	2,217,918,525
Rehabilitation Trust Fund	1,217,774,170
Total Rehab Funding – (30 June 2014)	3,435,692,695

Source: SAEC

Thus, there is a slight shortfall in SAEC's provision relative to the amount estimated as per the DMR method.

SAEC Closure Liability Provision

The estimated liability generated by the DMR methodology is generally considered to be lower than what costs actually are and excludes most water treatment costs. SAEC therefore also estimates the liability and has concluded that the numbers outlined in Table 9.4 are more representative of the likely closure liabilities. Xstract notes that the DMR liabilities are estimated as at a specific point in time (i.e. date of the determination), while SAEC's estimate takes into account future mining plans, as well as the time value of money.

Table 9.4 details SAEC's closure liability, excluding third party liabilities and closed mining operations (which were not assessed as part of this assessment), per mining operation as at 30 June 2013. The Closure Cost Assessment is updated annually. The liability is based on current contractor rates and rates incurred previously for similar work. It provides for demolition of infrastructure, water treatment, removal of roads and railway lines, etc.

SAEC estimates its Closure Liability using both Deterministic and Probabilistic means, with the expected liability also estimated. The Closure Liability Provision is calculated by discounted cash flow means and assessments are audited by both internal and external parties.

Table 9.4: SAEC's calculated liability

Mines (100%)	Expected (ZAR M)
WMC	4,479
Douglas Closure	613
Klipspruit	683
Phola (50%)	16
Khutala	489
Total (excl. 3rd party contributions and closed operations not forming part of this assessment)	6,280

Source: SAEC

Further to this, SAEC has planned for the following expenditure for the next five years as outlined in Table 9.5.

Table 9.5: Rehabilitation expenditure (next 5 financial years)

Rehabilitation expenditure in USD	FY 15	FY 16	FY 17	FY 18	FY 19	5 YR
	USM	USM	USM	USM	USM	Total
Mine Closure Water Plants	(8)	(2)	(1)	(15)	(4)	(30)
MWRP Water Plant (Capex & Opex)	(34)	(24)	(6)	(7)	(7)	(78)
DPS & EP-Semi – Passive Water Treatment Plant	(1)	(5)	0	0	0	(6)
Douglas Closure	(0)	(3)	(9)	(11)	(13)	(37)
Rehab Other Mines	(68)	(71)	(72)	(86)	(85)	(382)
Total Rehabilitation Cash Spend	(112)	(104)	(90)	(118)	(109)	(534)

Source: SAEC

Conclusion

SAEC and the DMR are in agreement with the quantum of liability in terms of the DMR method of calculation (ZAR3,560,282,456), and SAEC is largely funded for this liability (ZAR3,435,692,695) by means of trust funds and bank guarantees.

SAEC recognises that the DMR calculation does not account for all eventualities (especially with regards to water liability). As such, SAEC has prepared an internal estimate of the overall liability (ZAR6,280,000,000), which is appropriately recognised in SAEC's financial statements. Xstract commends SAEC on this initiative.

Xstract notes there is draft legislation under review, which may require mining companies to provide additional monies for added water liabilities not currently included in the DMR calculation methodology. Should this legislation be approved, mining companies may have a shortfall requiring them to increase their liability provisions.

SAEC has made provisions in its financial accounts for anticipated new legislation, which may require mines to provide for their water treatment and management liabilities.

10 Valuation of Coal Reserves

The valuation of SAEC's Coal Reserves represents Xstract's overall judgement as to value. They do not rely on any one particular scenario or set of economic assumptions. The valuation has been determined having regard to the sensitivity of the discounted cash flow ("DCF") analysis to a range of technical and economic assumptions.

Given the requirement to value the Coal Reserves at a date as close as practical to the potential listing date, Xstract has adopted a valuation date of 31 December 2014. This has required some modifications to the stated Coal Reserves by depleting for actual production to 30 October 2014 and then forecasting production from 1 November to 31 December 2014.

10.1 Valuation methodology

This valuation has been prepared in accordance with the VALMIN Code, which classifies mineral assets according to their maturity. Under this classification, the Wolvekrans-Middelburg, Klipspruit and Khutala Mines are regarded as operating mines.

Mineral assets are generally valued based on approaches that assess income, cost, and the open market. As the VALMIN Code is not prescriptive in this regard, the 2009 Edition of The South African Code for the Reporting of Mineral Asset Valuation ("SAMVAL") and the

2003 Edition of the Canadian Standards and Guidelines for Valuation of Mineral Properties ("CIMVAL") provide insight into applicable approaches, as shown in Table 10.1.

Table 10.1: Valuation approaches for different types of mineral assets

Approach	Project development stage			
	Exploration	Resource	Development	Operating
Income	No	Rarely	Yes	Yes
Cost	Yes	Rarely	No	No
Market	Yes	Yes	Yes	Yes

Source: (CIMVAL 2003)

On this basis, Xstract considers the income-based approach to be the most appropriate for the valuation of SAEC's Coal Reserves. The income-based approach is best suited for the valuation of individual assets for which a large amount of technical data has been collected or can be estimated. This approach involves the construction of a cash flow model based on projected technical and economic inputs and includes sensitivity and scenario analysis.

Despite its sophistication, the income-based approach has limitations in that it:

- may not fully reflect the market value
- relies on a number of subjective inputs (e.g. the appropriate discount rate).

In addition, a valuer must also be cognisant of what the project is deemed to be worth by the market and actual transactions taking place, to ensure that the estimates derived by DCF analysis are realistic. As such, Xstract has reviewed recent transactions involving coal assets of comparable standing to those held by SAEC in order to validate the value derived by DCF analysis.

The effective date for this valuation is 31 December 2014.

10.2 Discounted cash flow

10.2.1 Key assumptions

Xstract has assessed the value of SAEC's mines; Wolvekrans-Middelburg, Khutala and Klipspruit using a DCF method. The cashflows use are those provided by BHPB Billiton in their LOA schedules, as modified to account for Mineral Export Report specific requirements such as valuing only Coal Reserves.

The key valuation assumptions are as follows:

- Cash flow forecast is on an ungeared, all equity basis in real terms
- Consensus forecasts for coal pricing, exchange rate and inflation
- Bloomberg-derived inflation forecasts until FY16 and exchange rate forecast to FY15. Going forward, exchange rates are determined from the forecast inflation differential between the US and South African consumer price index ("CPI")
- Cash flow is escalated for depreciation and tax calculations
- A range of post-tax real discount rates between 9 and 13 per cent were applied
- NPV value was derived in USD from post-tax cash flows
- Valuation of the Coal Reserves is based on the revenue derived from the product splits at each of the operations, WMC, Kilpspruit and Khutala. Depending on the coal quality the product mix is a combination of Benchmark export product (approximately 6,000 kcal/kg NAR), 4,800 kcal/kg NAR, Domestic product (Eskom).

10.2.2 Inflation and exchange rate

Based on Bloomberg data, Xstract has used South African exchange rate forecasts until FY15 and inflation forecasts until FY16. In order to forecast exchange rates going forward, Xstract has then escalated at the inflation differential between the two projected inflation rates (i.e. for South African CPI relative to the US CPI) to determine the nominal exchange rate. The real exchange rate remains constant at USD1:ZAR11.27, as listed in Table 10.2.

Table 10.2: Inflation and Exchange rate forecast

Description	2015	2016	2017
US CPI	1.9%	2.1%	2.1%
South Africa CPI	6.0%	5.6%	5.6%
Inflation differential	1.0197	1.0544	1.0903
ZAR:USD (nominal)	11.27	11.88	12.29
ZAR:USD (real)	11.27	11.27	11.27

Source: Bloomberg, Xstract forecast

This valuation is reflective of SAEC's Coal Assets, based on our view in relation to Coal Reserves only. It is important to emphasise that this value does not represent the value of the Coal Reserves in the ground in isolation, but rather, incorporates the value of all of ungeared net assets contributing to the Asset based on a Coal Reserves production profile. For example, at SAEC's Mining Assets this includes the value of the use of processing facilities/truck fleet/rail loading facilities/rail entitlement/port infrastructure, as well as the mine.

10.2.3 Coal pricing

Given the potential range of coal prices is ultimately driven by the future supply and demand for thermal coal, Xstract has adopted a market consensus forecast published in September 2014 by Consensus Economics for the export product. The forecast Newcastle benchmark price was used as the basis price and a historic average discount of 7 per cent was applied to determine the Richards Bay 6,000 kcal/kg NAR index price (refer to Figure 8.2). The benchmark price as used by Xstract is publically available and provides the price for similar coal products as produced by SAEC. Table 10.3 lists the energy adjusted export price forecast used in this valuation.

Table 10.3: Export coal price forecast (nominal)

	2015 (USD/t)	2016 (USD/t)	2017 (USD/t)	2018 (USD/t)	2019 (USD/t)	2020 (USD/t)
Export - 6000 kcal NAR	72.31	73.33	78.50	82.09	84.67	88.07
Export - 4800 kcal NAR*	57.85	58.66	62.80	65.67	67.73	70.45

Source: Consensus Economics, Xstract estimates

* sales price adjusted for energy value

Domestic sales to Eskom power stations are based on agreed contract prices for WMC and Khutala.

Xstract considers there would be no material impact on the declaration of the SAEC Coal Reserves using the price assumptions noted in Table 10.3 as opposed to price assumptions

used to define the Coal Reserves as stated in BHP Billiton's 2014 Annual Report. Furthermore Xstract notes that should there be any change in the SAEC sales tonnage or product quality may have a material impact on the sales price and the overall value of the asset

10.2.4 Taxes and depreciation

Royalties

There are no private royalties payable for any of SAEC's Coal Assets. State royalties as per the *Mineral and Petroleum Resources Royalty Act 28 of 2008* (the "Royalty Act") are payable however.

At Khutala, Eskom is responsible for the payment of royalties associated with coals from the No.2 and No.4 Seams.

The "Royalty Act" regulates the imposition and calculation of mining royalties. Mining royalties are deductible for income tax purposes. For unrefined mineral resources such as coal, the formula to determine the percentage or rate (which has to be applied to the tax base) is:

$$0.5 + [\text{EBIT} / (\text{gross sales in respect of unrefined mineral resources} \times 9)] \times 100$$

The percentage determined by the formula must not exceed 7 per cent.

Gross sales are defined as the transfer of all mineral resources as defined in Schedule 1 and 2 of the Act. Various inclusions and exclusions apply.

EBIT (earnings before interest and taxes) is defined as the aggregate of gross sales less any valid deductions in terms of the *Income Tax Act*.

Corporate tax and depreciation

The corporate tax rate in South Africa is 28 per cent. Xstract has applied an effective corporate tax rate of 31.5 per cent that includes the impact of withholding tax in South Africa.

Capital expenditure is deducted in the year of its expenditure against taxable income. The capital expenditure in respect of any year of assessment that exceed the taxable income derived in that year, may be carried forward and can be deducted in the next succeeding year of assessment.

Closure provisions

A provision of ZAR1.962 Bn is in place for defunct and derelict mines which will have an impact on the overall valuation of SAEC. In the overall valuation of SAEC this provision is largely offset by trust fund of ZAR1.681 Bn

Importantly this report values the currently defined Coal Reserves and as such this provision for closed and defunct mines does not affect the valuation outlined in this report. However Xstract's valuation of the Coal Reserves includes the cost of closing the currently operating mines

Net present value

The value of SAEC's Coal Reserves have been estimated using the DCF methodology, which estimates the market value of an asset by discounting the future cash flows to their net

present value ("NPV"), using an appropriate discount rate. Our consideration of each of these factors is set out below.

Future cash flows

The future cash flows in the model have been prepared on a real, post-tax, 100 per cent all-equity, not already financed basis as required by the VALMIN Code.

Discount rate

A range of real discount rates, where applied to the projected USD free cash flow, between 9 and 13 per cent. This is an effective nominal discount range of 11.3 to 15.4 per cent.

To quantify the risk premium, Xstrat has estimated South32's cost of equity using the capital asset pricing model ("CAPM") at approximately 9.7 per cent nominal or 7.4 per cent real (Table 10.4), assuming a listing in London. Given the all equity basis of this valuation, no debt has been assumed.

Table 10.4: Cost of Equity

Parameter	Value	Comment
Estimate of beta	1.55	Average beta of select comparable companies, data from Bloomberg
Market return	7.43%	S&P/ASX 300 Metals and Mining 10 years return
Risk free rate	3.27%	UK 10 year gilt yield
Risk premium	4.16%	Market return less risk free rate
Return on equity estimate	9.72%	Capital asset pricing model

This suggests that Xstrat has applied a risk premium over the cost of equity between 1.6 and 5.6 per cent (nominal basis) to determine a NPV range for SAEC's Coal Reserves. Xstrat considers the risk premium range to be appropriate given it must account for conventional mining, process technology, country and other associated risks.

The valuation date is 31 December 2014, with future free cash flows discounts back to this date.

10.3 Valuation of Wolvekrans-Middelburg

10.3.1 Revenue

To forecast the revenue profile, Xstrat has modified WMC's LOA model to account for only Coal Reserves as per specific Competent Persons Report requirements. In Xstrat's analysis of WMC, three scenarios considered:

1. Excluding Inferred Resource from VDD South and Albion. Keep supply commitment to Eskom of 8.5 Mtpa. Reduced variable operating cost and capex accordingly. Export coal price based on 6,000 kcal/kg product with a 7 per cent discount to Newcastle pricing.
2. Original WMC production profile including Inferred Resource. Export coal price based on a 6,000 kcal/kg product with a 7 per cent discount to Newcastle pricing.
3. Excluding Inferred Resource from VDD South and Albion. Sales tonnes for Export and Eskom are reduced proportionally. Assumed Eskom sales will be made up by some

other means. Have reduced variable operating cost and capex accordingly. Export coal price based on 6,000 kcal/kg 7 per cent discount to Newcastle pricing.

Scenario 3 was used as the basis of Xstract’s DCF analysis for WMC as this was considered to be the most realistic case going forward. On this basis, Xstract has scheduled 495.0 Mt of ROM Coal Reserves from WMC for mining and delivery of 369.8 Mt of product over the remaining 23.5 years of mine life to 2038.

The WMC Complex produces two export and one domestic product. Approximately 50 per cent of product is for export at a 6,000 kcal/kg price, while only 10 per cent is sold at the 4,800 kcal/kg export price. The remaining 40 per cent is sold domestically at a 22.7 MJ/kg specific heat value (Figure 10.1).

The domestic product is sold to Eskom’s Duvha power station under a fixed price contract. While the exact terms of the Duvha coal supply contract remain confidential, it stipulates delivery of 8.5 Mtpa with a CV of 22.7 MJ/kg. The contract is for a fixed price, which is escalated twice a year using a weighted average of various inflation indices that include, but are not limited to labour, electricity, explosive and spars. SAEC’s coal deliveries to Duvha are scheduled to end in 2033 (Figure 10.1).

In scheduling only the Coal Reserves contained in the LOA plan, Xstract has assumed that sales to each market is reduced proportionally between 2024 and 2033. Xstract assumes that SAEC will make up the Eskom short fall to 8.5 Mtpa by either third party purchases or production from other mines within the SAEC group.

Figure 10.1: Wolvekrans-Middelburg sales tonnes (Scenario 3)

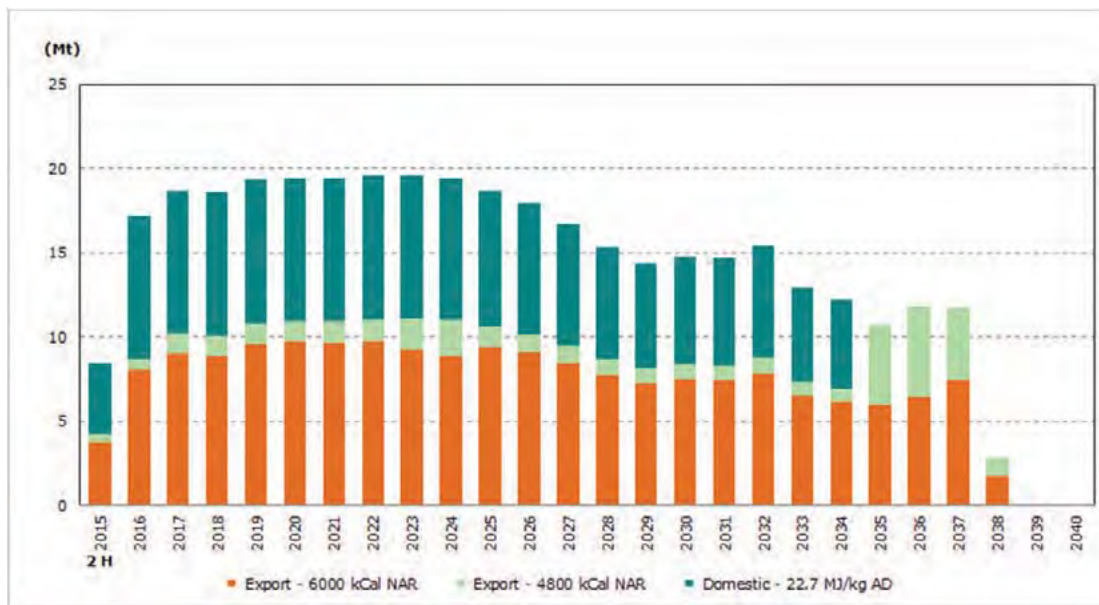

Source: SAEC, Xstract estimates

10.3.2 Cash Flow (Scenario 3)

Operating costs average in real terms USD679 M per year as illustrated in Figure 10.2. The operating margin averages 15 per cent over the life of the Reserve.

Sustaining and project capital expenditure amount to a total real USD922 M and USD677 M of the life of the scheduled Reserve, respectively.

Rehabilitation expenditure takes place beyond the LOA Reserves and amounts to a total of USD1,002 M (real).

Tax including royalty payments average a real USD32 M per year.

WMC averages a free cash flow of USD6 M per year in real terms over the life of the Coal Reserves.

Figure 10.2: WMC cash flow (Scenario 3)

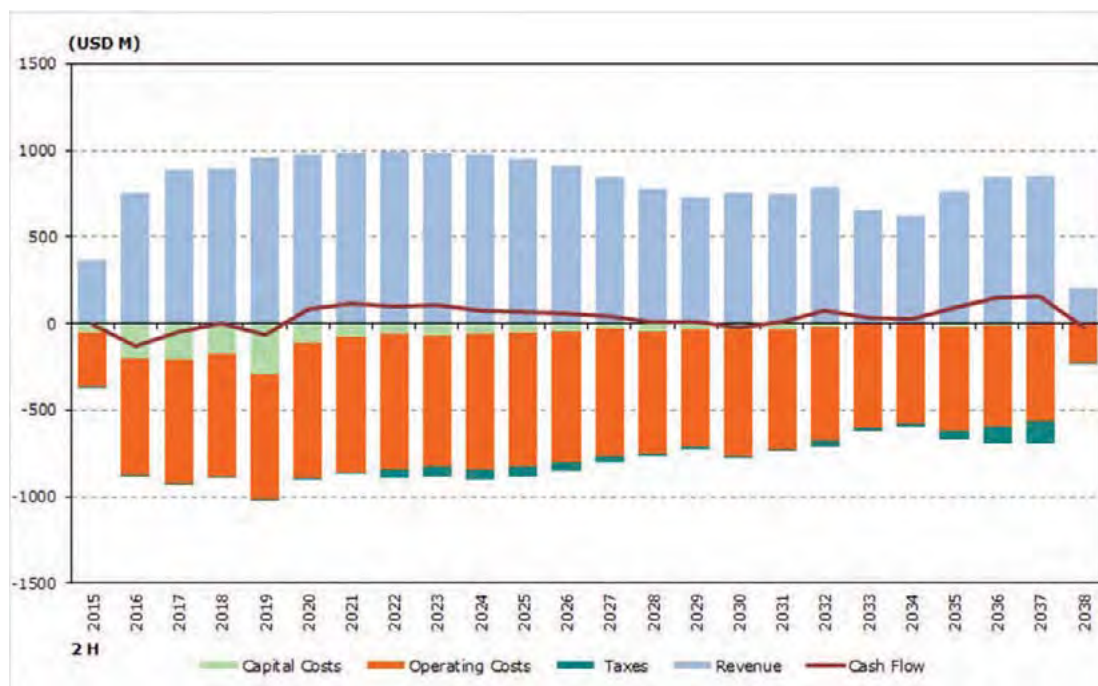

Source: Xstract estimates

10.3.3 Discounted net present value

Based on the assumptions set out in Section 10, a summary of Xstract's NPV under a range of real discount rates is listed in Table 10.5. Based on its Scenario 3 analysis of the Reserves for WMC with proportional sales to the export and domestic markets as the most likely outcome, Xstract considers the market would value a 100 per cent interest in the WMC Coal Reserves at between USD101.3 M and USD145.4 M.

Table 10.5: Summary of the Valuation of WMC

Description	Unit	1 - Reserves, maintaining Eskom sales	2 - Reserves and Inferred Resources	3 - Reserves, proportional sales
Production parameters				
Life of mine	years	23.5	23.5	23.5
Peak annual ROM production	Mt pa	26.9	30.9	26.9
Scheduled Coal Reserves (JORC Code compliant)	Mt	495.0	566.6	495.0
Stripping (average)	bcm/t ROM	5.6	5.3	5.6
Economic parameters				
Average Price Received	USD/t Prod	48.94	52.22	51.97
Operating cost (excl. Royalty)	USD/t Prod	43.24	41.73	43.92

Description	Unit	1 - Reserves, maintaining Eskom sales	2 - Reserves and Inferred Resources	3 - Reserves, proportional sales
Capital cost	USD M	1,672	1,881	1,672
Net Present Value				
9% (real)	USD M	12.4	279.7	171.5
10% (real)	USD M	6.8	234.4	145.4
11% (real)	USD M	1.1	195.1	122.1
12% (real)	USD M	(4.4)	161.0	101.3
13% (real)	USD M	(9.8)	131.3	82.7

Source: Xstract estimates

High capital expenditure between 2016 and 2019 as illustrated in Figure 10.2, negatively impact on the NPV of WMC. Any opportunity to reduce capital expenditure over this period is expected to result in a significant uplift to project NPV.

10.3.4 Sensitivity analysis

Xstract's value for WMC has been tested for sensitivity to the key parameters of export price, exchange rate, waste removal costs, coal mining costs, processing costs and capital expenditure (Figure 10.3).

Approximately 60 per cent of production is sold on the export market and as a result, mine NPV is most sensitive to both the exchange rate and the export coal price. A 10 per cent increase in the export coal price results in a 290 per cent improvement in NPV. A 10 per cent fall in the exchange rate produces a 252 per cent improvement in NPV.

Figure 10.3: NPV sensitivity of WMC

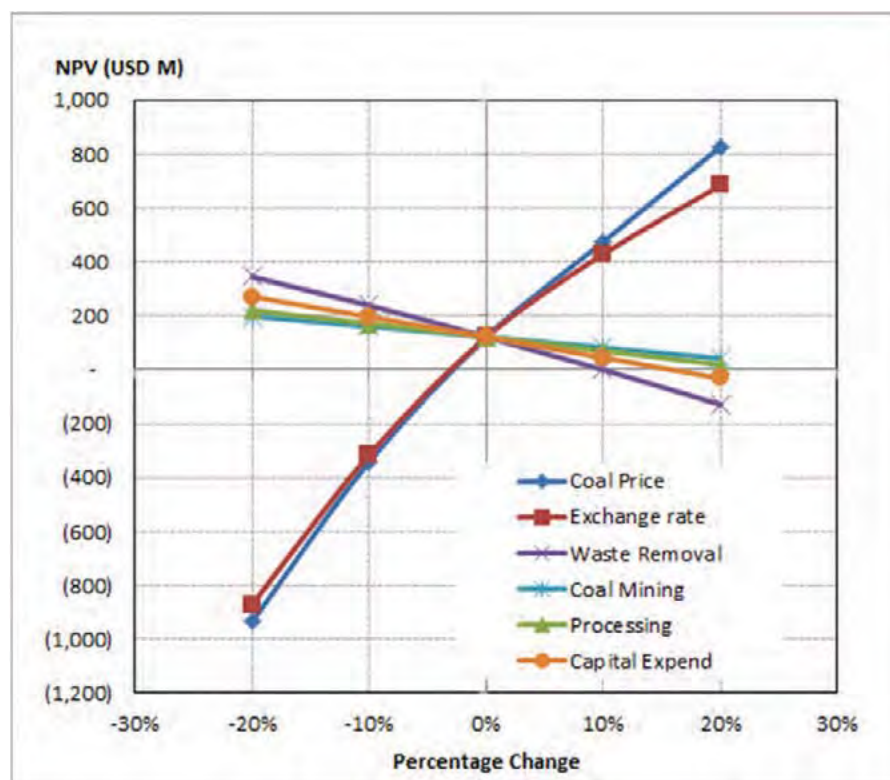

Source: Xstrat estimates

Waste removal cost comprise the largest proportion (approximately 31 per cent) of operating costs and as a result have a larger impact on Project NPV than either coal mining or processing costs, which account for 16 per cent and 12 per cent of costs, respectively. A 10 per cent reduction in waste removal, coal mining and processing costs results in an improvement of 96 per cent, 32 per cent and 40 per cent in NPV, respectively.

Reducing capital expenditure by 10 per cent improves Project NPV by 61 per cent.

10.4 Valuation of Klipspruit

10.4.1 Revenue

To forecast the revenue profile, Xstrat has modified SAEC's Klipspruit LOA model to account for only Coal Reserves as per specific Competent Persons Report requirements. On this basis, Xstrat has scheduled 39.2 Mt of the presently defined Coal Reserves from the Klipspruit Mine over the remaining 5.5-year life to 2020. Klipspruit produces two export quality thermal washed products. Approximately 50 per cent is benchmark product, while the remaining 50 per cent is sold at a 4,800 kcal/kg (Figure 10.4). The forecast prices are listed in Table 10.3. The average real price realised in this valuation is USD67.34/t.

In addition, SAEC is paid by Anglo Inoyisi for disposing ash discard from the adjacent Phola wash plant into the Klipspruit open pit. The associated revenue is estimated at USD13 M over the remaining 5.5 years of life of the operation.

Figure 10.4: Klipspruit export tonnes

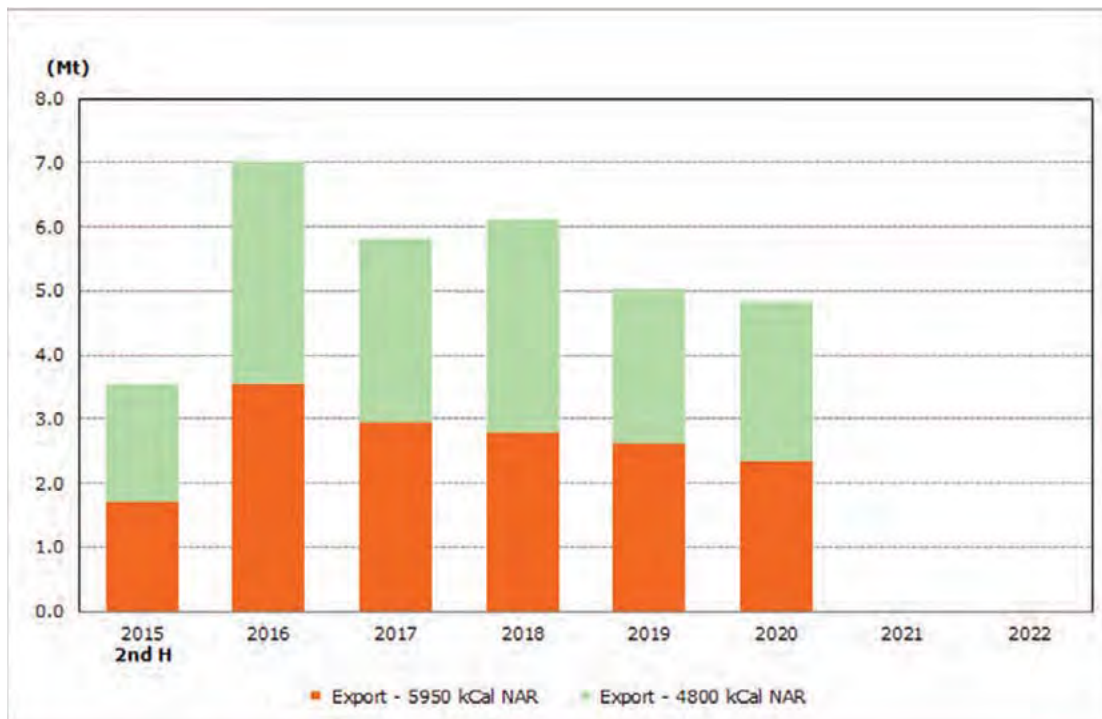

Source: Xstrat estimates

10.4.2 Cash flow

Operating costs average in real terms USD166 M per year with USD18 M sustaining capital capital expenditure in the next three years as illustrated in Figure 10.5. Rehabilitation expenditure takes place beyond the LOA Reserves until 2030. An annual average operating margin of 36 per cent is achieved until 2020.

Taxes including royalty payments average USD72 M per year.

Klipspruit averages a free cash flow of USD92 M per year in real terms.

Figure 10.5: Klipspruit cash flow

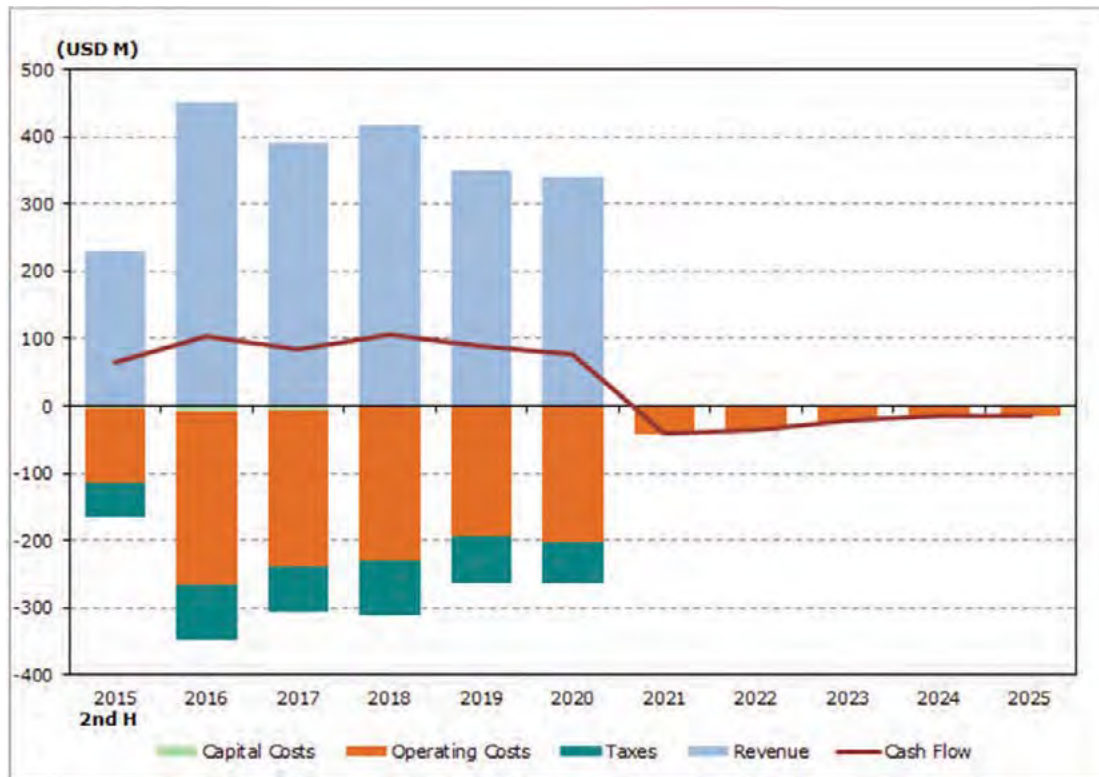

Source: SAEC, Xstract estimate

10.4.3 Discounted net present value

Based on the assumptions set out in Section 10, Xstract has summarised the Klipspruit Mine NPV over a range of real discount rates as listed in Table 10.6. In Xstract’s opinion, the market would pay between USD320 M and USD329 M for a 100 per cent interest in the Klipspruit Coal Reserves.

Table 10.6: Summary of the Valuation of Klipspruit

Description	Unit	Value
Production		
Life of mine	years	5.5
Peak annual ROM production	Mt pa	8.6
Scheduled Coal Reserves (JORC Code compliant)	Mt	39
Stripping (average)	bcm/t ROM	2.5

Description	Unit	Value
Economic		
Average Price Received	USD/t Prod	67.34
Operating cost (excl Royalty)	USD/t Prod	43.34
Sustaining capital cost	USD M	18
Net Present Value		
9% (real)	USD M	332.9
10% (real)	USD M	328.8
11% (real)	USD M	324.5
12% (real)	USD M	320.1
13% (real)	USD M	315.6

As illustrated in Table 10.6, the narrow valuation range is indicative of the high operating cash flow margin and low capital expenditure requirements resulting in a low sensitivity to a varying discount rate.

10.4.4 Sensitivity analysis

Xstrat's preferred value of the Klipspruit Coal Reserves was tested for sensitivity to the key parameters of export price, exchange rate, waste removal costs, coal mining costs, processing costs and capital expenditure (Figure 10.6).

Figure 10.6: NPV sensitivity of Klipspruit

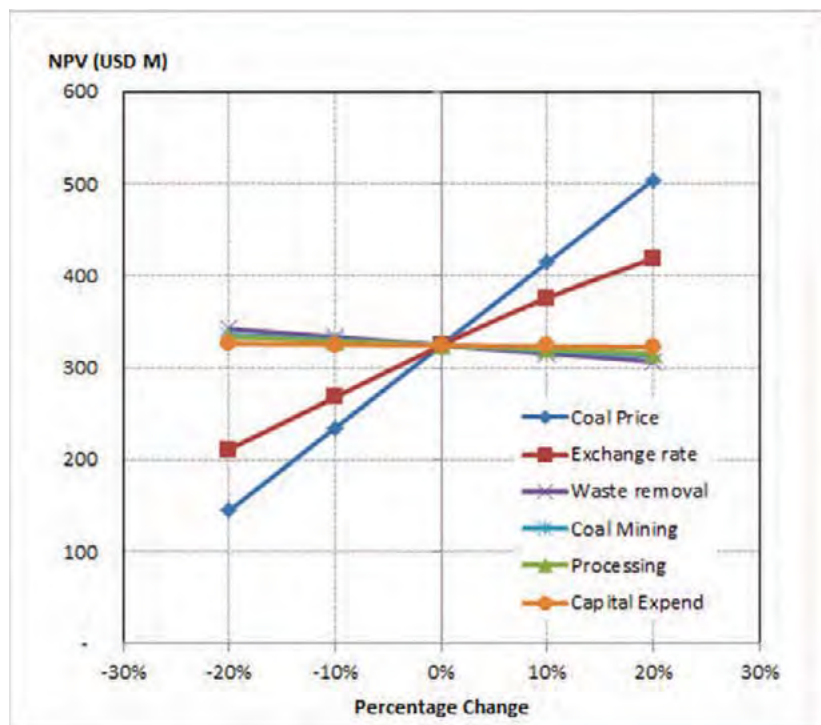

All of Klipspruit's production is sold on the export market and therefore NPV is most sensitive to both changes in the exchange rate and the export coal price. A 10 per cent improvement in coal price or depreciation in the exchange rate improves the NPV by 28 per cent and 16 per cent, respectively.

NPV is significantly less sensitive to a change in costs. A 10 per cent reduction in waste removal, coal mining and processing costs only improves NPV by 2 to 3 per cent. A change in capital expenditure makes no material change in Project NPV.

10.5 Valuation of Khutala

10.5.1 Revenue

Khutala Mine is contracted to supply coal to Eskom's Kendal power station based on a cost-plus price mechanism, which includes a reimbursement and return on investment component. The calorific value delivered to the power station is expected to range between 17.9 MJ/kg and 18.9 MJ/kg (AD).

To forecast the revenue profile, Xstract has modified SAEC's Khutala's LOA model to account for only Coal Reserves as per specific Competent Persons Report requirements. On this basis, Xstract has scheduled 33.6 Mt of SAEC's defined Coal Reserves for mining and delivery of 31.1 Mt over the remaining 5.5 year life to 2020 (Figure 10.7). There is an implied 7 per cent loss due to crushing, screening and destoning.

Figure 10.7: Production and sales profile of Khutala Mine

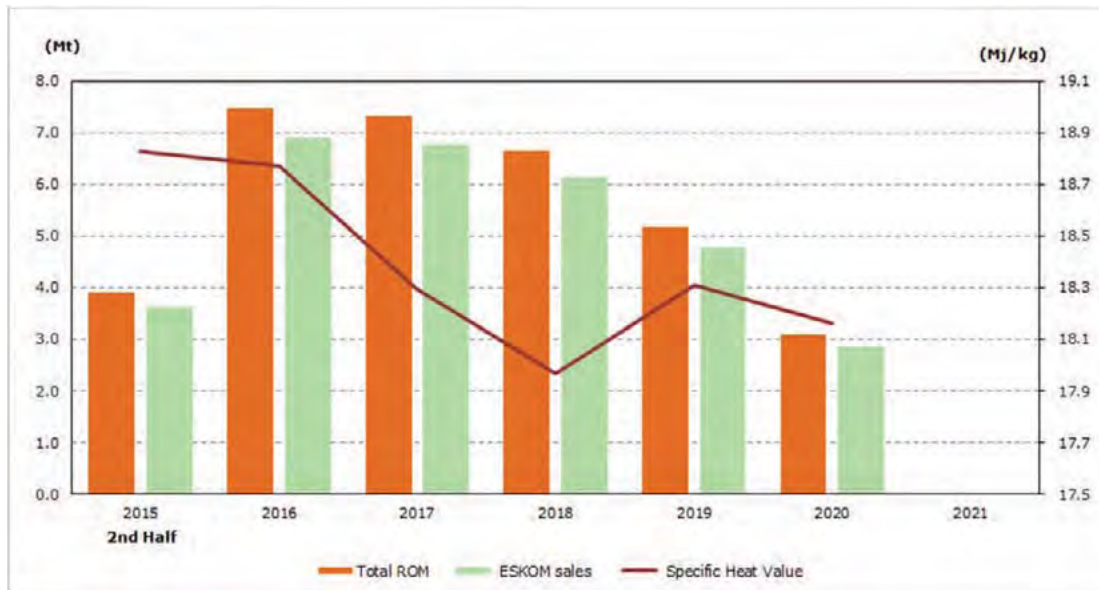

Source: SAEC, Xstract estimate

10.5.2 Cash flow

Operating costs average in real terms USD188 M per year between 2016 and 2020 as illustrated in Figure 10.5 but tail off towards the end of the mine life with the decline in production. Operating costs are inclusive of sustaining capital and rehabilitation expenditure. Rehabilitation expenditure takes place beyond the life of the mine Reserves. An annual average operating margin of 5 per cent is achieved until 2020.

Tax payments average USD4 M per year. Royalties are reimbursed by Eskom.

Khutala averages a free cash flow of USD9 M per year in real terms.

Figure 10.8: Khutala cash flow

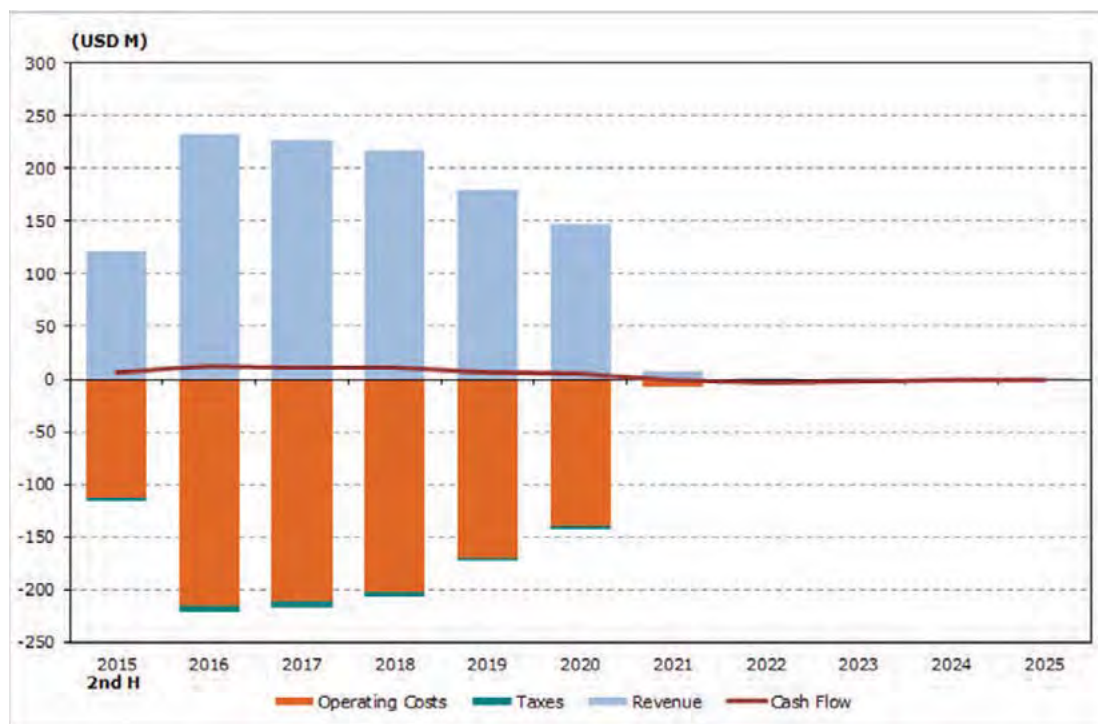

Source: SAEC, Xstract estimate

10.5.3 Discounted net present value

Based on the assumptions set out in Section 10, Xstract has considered a range of real discount rates as listed in Table 10.7 to determine the NPV of the Khutala Mine.

Xstract's considers the market would value a 100 per cent interest in the Khutala Coal Reserves at between USD33 M and USD34 M. The small range in project values is indicative of the Eskom agreement, which enforces a cost plus pricing basis (with the exception of No.5 Seam workings), delinking the project from any market volatility.

Table 10.7: Summary of the Valuation of Khutala

Description	Unit	Value
Production		
Life of mine	years	5.5
Peak annual ROM production	Mt pa	7.5
JORC Reserves scheduled	Mt	33.6
Economic		
Average Price Received	USD/Prod t	40.54
Operating cost (excl. Royalty)	USD/Prod t	38.67
Sustaining capital cost	USD M	92
Net Present Value		
9% (real)	USD M	34.7
10% (real)	USD M	34.3
11% (real)	USD M	33.9

Description	Unit	Value
12% (real)	USD M	33.4
13% (real)	USD M	32.9

10.6 Sensitivity analysis

The structure of the Eskom contract limits any variability in NPV on a ZAR basis with changes in costs at Khutala mine. However, a movement in the exchange rate obviously directly affects the USD value.

10.7 Market support

In order to validate the values derived by DCF analysis, Xstract has considered recent transactions involving similar quality assets to those held by SAEC.

Xstract subscribes to the SNL ("SNL") and IntierraRMG ("Intierra") databases, which have been used for more than five years to obtain comparable transaction information. In Xstract's experience, the information provided on these databases is reliable and trustworthy.

Xstract has used transaction data on coal mines and projects that were located in South Africa for which have reported Coal Reserves. The valuation derived from this information is shown in Table 10.8.

Table 10.8: Comparable Market Transactions

Stage/Coal	Close Date	Property Name	Buyer	Ownership at time of transaction	Transaction (USD/Reserves t)	Normalising Factor	Normalised Transaction (USD/Reserves t)
Mine: Thermal	31-Oct-13	Kendal Mine	Joe Singh Group of Companies (Pty) Ltd	Homeland Energy Group Ltd - 74.0% African Spirit Trading 307 (Pty) Ltd - 26.0%	1.47	1.22	1.20
Mine: Thermal	22-Sep-14	Mooiplaats Mine	Blackspear Holdings Pty Ltd	Coal of Africa Limited (Operator) - 74.0%	1.00	1.03	0.97
Mine: Thermal	10-Mar-14	Woestalleen Mine	Blue Falcon 212 Trading Pty Ltd	Coal of Africa Limited (Operator) - 100.0%	6.91	1.13	6.11
Mine: Thermal	29-Jun-09	Springlake Holdings Pty Ltd	Shanduka Coal Pty Ltd	Petmin Ltd	0.87	0.93	0.94
Mine: Thermal	30-Jun-14	New Clydesdale Mine	Universal Coal Plc	Exxaro Resources	4.59	1.12	4.09
Project: Anthracite	21-Feb-11	Kangwane Central Coal	Zyl Limited	Exsteen Pty Ltd - 50.1%	0.76	1.78	0.42
Project: Thermal	12-Jul-12	Moabsvelde Coal	Thebe Investment Corporation	Keaton Energy Holdings Limited (Operator) - 74.0%	0.59	1.32	0.45
Project: Thermal	31-Dec-13	Waterberg #1 Coal Deposit	Fairy Wing Trading 136 (Pty) Ltd	Resource Generation Limited	0.05	1.28	0.04

Source: Intierra

10.7.1 Comparable market transactions

Xstract has identified eight transactions that are considered comparable. Of these, five are mining operations and three are projects with Reserves. The USD per Reserve tonne value was then normalised by multiplying the coal price at the time of the transaction and dividing by the coal price at the time of this valuation. This effectively expresses all the transactions in the value of the coal price as at the valuation date.

From Xstract's analysis, transactions for coal assets with Coal Reserves range between USD0.04/t and USD6.11/t with an average of USD1.78/t.

10.7.2 Trading company multiples

As outlined in Section 10.2, Xstract has also considered Market traded multiplies to cross check its valuation of Reserves as shown in Table 10.9.

Table 10.9: Traded Market Multiples of Comparable Coal Companies

Company	Listed Country	Attributable Marketable Reserves (t)	EV (AUD) 12/11/2014	EV (USD) (@ 0.875)	EV/Reserve (USD/t)
New Hope Corp Ltd	Australia	638,800,000	2,126,203,628	1,860,428,175	2.91
Whitehaven Coal Ltd	Australia	648,700,000	899,067,840	786,684,360	1.21
Continental Coal	South Africa	35,134,000	206,696,542	180,859,474	5.15
Universal Coal	South Africa	22,148,750	28,162,217	24,641,940	1.11
Coal of Africa	South Africa	535,912,000	68,664,423	60,081,370	0.11
PT Adaro Energy Tbk	Indonesia	1,126,750,000	2,683,436,706	2,348,007,118	2.08
PT Bayan Resources Tbk	Indonesia	503,220,000	1,778,390,434	1,556,091,630	3.09

Source: Intierra

Trading multiplies of Enterprise Value per Marketable Reserve range between USD0.11/t to USD5.15/t. These values will not only reflect the value of the Reserves but also any upside and downside such as additional resources or lack thereof. Xstract's value of Reserves for the SAEC assets does not reflect any upside or downside.

10.7.3 Summary of market approach

While WMC and Khutala EV/Reserve tonne is within the range of its peer group, Klipspruit EV/Reserve tonne multiple is significantly higher. Xstract ascribes this to Klipspruit's high realised price and operating margin, as well as low capital expenditure requirement.

While the transaction data supports the results derived through DCF analysis, it is Xstract's opinion that the DCF modelling results provide a more conclusive indication of the market value of SAEC's Reserves.

Table 10.10: Summary of SAEC NPV per Reserve multiple

SAEC mine	Attributable Marketable Reserves (Mt)	EV (USD M)	EV/Reserve (USD/t)
WMC	310.6	143.9	0.39
Klipspruit	32,4	324.5	10.03
Khutala	31,1	33.9	1.13

10.7.4 Precedent transactions

Xstract is not aware of any precedent transactions involving SAEC's Coal Reserves in the recent past.

10.7.5 Previous valuations

Xstract is not aware of any previous valuations of SAEC's Coal Reserves prepared in accordance with the VALMIN Code in the public domain.

10.8 Other considerations

The value assessed in Xstract's DCF analysis of WMC, Klipspruit and Khutala considers only the currently defined Coal Reserves as defined by SAEC. Xstract is also cognisant of the following:

10.8.1 Additions to scheduled Coal Reserves

- At WMC, there is an additional 72 Mt of Inferred Resources for the Vandyksdrift and Albion open pits in the current mine plan. Given the requirement to value only Ore Reserves as part of this Competent Persons Report, these additional Resources were not valued.

10.8.2 Optionality associated with defined Mineral Resources

- WMC has an additional 345 Mt as defined Coal Resources not currently included in the mine plan.
- At Klipspruit, there is an additional 96 Mt of Resources in the Klipspruit South area, which is currently being evaluated under pre-feasibility level studies as part of the whole Klipspruit mine extension plan. Given the requirement to value only Ore Reserves as part of this Competent Persons Report, these additional Resources were not valued.
- Khutala has a Coal Resource of 1,328 Mt (depleted to 30 December 2014) of which only 34 Mt is currently scheduled as Coal Reserves. Most of the defined Coal Resource comprises No.2 and No.4 Seam coals, which are allocated to Eskom.
- Khutala life extension project is currently being evaluated and is intended to transition the Khutala Mine from underground to open cast mining. To date there has been no commitment from either SAEC or Eskom to mine the defined Coal Resources under the Khutala life extension project.

10.8.3 Other

- The strategic location of SAEC's portfolio relative to other third party coal producers in the Witbank Coalfield, along with its proximity to established transport infrastructure, is likely to be highly attractive to the market.

- Eskom has recently executed agreements with other third parties on export linked pricing terms. There may be an opportunity to negotiate improved terms from Eskom for coal supply to Duvha and Kendal Power Stations.
- Access to the Klipspruit South area requires relocating a conveyer belt system that runs directly over the area, which is tied to an agreement with Anglo Inoyisi until 2019. The opportunity lies in renegotiating with Anglo Inoyisi to access this Resource.
- The Klipspruit Mine is a significantly higher margin coal producer than SAEC's other assets and along with its proximity to established processing and transport infrastructure, it is likely to hold considerable appeal.
- At Khutala, No.5 Seam Coal Resources are not dedicated to Eskom and comprise a higher quality coal than either No.2 or No.4 Seams. Coal from No.5 Seam has been and continues to be mined and sold to the domestic metallurgical market. These No.5 Seam Resources are expected to achieve a substantially higher price than currently achieved for either the No.2 or No.4 Seam coals.
- Analysts suggest the recent market has been applying a discount to project NPV as measured by Price/Net Asset Value or NPV/share ratios. This suggests that analysts believe the market is not recognising and paying for project upside.

10.9 Valuation summary

Xstract has carried out a NPV valuation using a range of real discount rates of the currently defined Coal Reserves held under SAEC's Mining Assets, as summarised in Table 10.11.

Table 10.11: Summary Valuation of SAEC's Mining Asset Coal Reserves on 100 per cent terms

Description	Unit	WMC	Klipspruit	Khutala	SAEC
Production					
Life of Reserves	years	23.5	5.5	5.5	
Peak annual ROM production	Mt pa	26.5	8.6	7.5	
Scheduled Coal Reserves (JORC Code compliant)	Mt	495	39	33.6	
Stripping (average)	bcm/ROM t	5.6	2.6		
Economic					
Average Price Received	USD/Prod t	51.97	67.34	40.52	
Operating cost (excl. Royalty)	USD/Prod t	43.92	43.34	38.67	
Capital cost	USD M	1,672	18	92	
Net Present Value					
9% (real)	USD M	171.5	332.9	34.7	539.0
10% (real)	USD M	145.4	328.8	34.3	508.4
11% (real)	USD M	122.1	324.5	33.9	480.4
12% (real)	USD M	101.3	320.1	33.4	454.8
13% (real)	USD M	82.7	315.6	32.9	431.2

Source: Xstract estimates

Based on the calculations described above, Xstract has assigned values for a 100 per cent interest in the defined Coal Reserves, as summarised in Table 10.12. These assigned

values are the total intrinsic values of the respective assets and the values that would be attributable to SAEC.

Table 10.12: Assigned Value of the defined Coal Reserves on 100 per cent terms

Project	Low (USD M)	High (USD M)	Preferred (USD M)
WMC	101.3	145.4	122.1
Klipspruit	320.1	328.8	324.5
Khutala	33.4	34.3	33.9

Source: Xstrat estimates

This valuation is reflective of SAEC's Coal Assets, based on our view in relation to Coal Reserves only. It is important to emphasise that this value does not represent the value of the Coal Reserves in the ground in isolation, but rather, incorporates the value of all of ungeared net assets contributing to the Asset based on a Coal Reserves production profile. For example, at SAEC's Mining Assets this includes the value of the use of processing facilities/truck fleet/rail loading facilities/rail entitlement/port infrastructure, as well as the mine.

11 Concluding remarks

From its independent review of SAEC's operations, Xstrat considers that:

- SAEC's Mining Assets are well managed at an operating level and the management and technical teams have a strong understanding of key drivers capable of impacting short, medium and long-term planning objectives
- The mine plans appropriately consider geological and geotechnical factors to minimise mining hazards.
- the Company's proposed mine plans are based on mining equipment (either in place or as planned in capital estimates) that is well suited to this mining environment and is adequate, with minor adjustments for the production plans
- Coal processing plants and other infrastructure are capable of continuing to supply appropriate quality products to both domestic and export markets in line with the forecast production plans
- Environmental issues are managed and any issues that could materially impede production and or future development are well recognised. Mitigation steps are currently being evaluated by SAEC.
- Other than Eskom claim at Khutala Xstrat is not aware of any other litigation.
- In estimating both capital and operating costs, SAEC's assumptions are supported by sufficient technical studies for the development status. In general, the estimates appear reasonable and are broadly in line with industry benchmarks.
- SAEC's techno-economic assumptions as incorporated in the financial model are supported by supplied information, and appear appropriate and reasonable.
- Capital and operating costs used in the financial models incorporating minor adjustments by Xstrat reflect the mine plans, development and construction schedules and the forecast production levels
- The mine plans and cost forecasts appropriately account for the risks identified. These risks are generally well understood by management and appropriate action to mitigate these risks is being taken.
- Management are able to monitor and forecast production and cost parameters.

Xstract has estimated the value of SAEC's South African Coal Reserves as USD480.4 M on 100 per cent equity basis assuming a real discount rate of 11 per cent, an exchange rate of 11.27 ZAR/USD, and product prices, capital and operating costs and production forecasts, which are soundly based.

12 Consultant qualifications and experience

Kevin Irving | General Manager & Principal Consultant | Mining

Kevin has some 30 years of mining engineering experience in mine management, corporate roles and consulting. Before joining Xstract, Kevin was Group Manager – Coal for Snowden Mining Industry Consultants, based in Brisbane. Before this, he was Vice President of Operations for UK Coal Plc where he had a successful track record of managing a group of coal mines with a combined turnover of circa AUD1.2 billion. Kevin's experience includes an in-depth knowledge of leading people, financial management, planning, scheduling and forecasting and consulting. His skills lie in establishing teams of diverse people to conduct concept, pre-feasibility, feasibility studies, mine optimisation, due diligence and technical audits. Kevin holds a Master of Business Administration and a Bachelor of Science with Honours in Mining. He is a Fellow of the Australasian Institute of Mining, a Fellow of the Institute of Material, Minerals and Mining, a Chartered Engineer and a Member of the Institute of Management.

Jeames McKibben | General Manager & Principal Consultant | Corporate Advisory

During more than 20 years in the mining industry, Jeames has served in a diverse range of roles including corporate consultant, project manager, geologist and analyst. He has a strong record in project due diligence, independent technical review, valuation and deposit evaluation. Jeames has assisted numerous mineral companies and financial and legal institutions in securing regulatory approvals for IPOs and other secondary filings on a range of international exchanges. As a corporate consultant, he specialises in valuations and Competent Persons Reports for equity transactions and Independent Technical Reports in support of project finance. Other mandates include technical due diligence in support of information memoranda, divestments, acquisitions and mergers, pre-feasibility studies and independent Competent Persons' Reports. Jeames holds a Master of Business Administration and a Bachelor of Science with First Class Honours, is a Member of the Australian Institute of Geoscientists and a Chartered Professional Member of the Australasian Institute of Mining and Metallurgy. He is a current member of the VALMIN Code Review Committee.

Mark Noppe | General Manager & Principal Consultant

Since graduating as a geologist in 1983, Mark has worked in South Africa, Western Australia and Queensland in exploration, mining geology, practical geostatistics applications, resource estimation, grade control, mine reconciliation, and professional training and mentoring. Mark has been consulting since 1995 and his technical experience covers a wide range of commodities, geological and mining settings. He has held positions as Chairman of the Southern Queensland branch of the Australasian Institute of Mining and Metallurgy, and the Geostatistical Association of Australasia. Mark holds a Master of Science in Exploration Geology, a Graduate Diploma specialising in Terrain Evaluation, a

Bachelor of Science in Geology and Chemistry, and is a Chartered Professional Member of the Australasian Institute of Mining and Metallurgy.

Mathew Longworth | General Manager & Principal Consultant | Xstract

Mathew is a geologist with 25 years' experience across exploration, project evaluation/development, operations and corporate management. He previously held roles as Exploration Manager, COO and CEO/Managing Director with Australian listed companies, and as a mining analyst with a boutique investment fund. He has led multidisciplinary project evaluation and development teams across a range of geological and geographic environments. Mathew has also been instrumental in the listing of a number of companies, in addition to acting as the link between corporate and technical advisors in fundraising and corporate transactions. He combines Board level experience with a strong technical and commercial background. Mathew holds a Bachelor of Science with Honours in Geology, and is a Member of the Australasian Institute of Mining and Metallurgy and the Australian Institute of Company Directors.

Ian de Klerk | Principal Consultant | Geology

Since graduating in 1985, Ian has worked on mining operations across southern Africa and has consulted in a number of boutique consultancies. In these roles, Ian has been responsible for a range of activities across multiple commodities. His specialties include coal due diligence and technical reviews, coal quality and product interpretations, coal exploration advice and planning, geological modelling, and documentation of coal resources in accordance with the JORC Code. Ian holds a Master of Science degree in Exploration Geology, a Graduate Diploma in Engineering (Mining), and is a Member of the Australasian Institute of Mining and Metallurgy.

Michael Creech | Associate Consultant | Geology

Michael is a Competent Person Coal Resources and Exploration and has worked in the mining industry for over 30 years. His experience spans the minerals, coal and coal seam gas industries with positions in exploration and production roles, and more recently, managerial positions. He has been involved in due diligence and evaluation work and his qualifications and experience to meet the requirements of a Competent Person for reporting resources under the JORC Code. His PhD research led directly to the discovery of what is now the Mangoola Mine operated by Xstrata in the Hunter Valley, New South Wales.

Mark Bowater | Associate Consultant | Mining

Mark has held engineering and managerial roles at some of Australia's leading mining operations and consultancies including Hamersley Iron, Paraburdoo and the Burton Coal Project. Mark has substantial mining engineering experience working in all open cut engineering roles from drill and blast through to short- and long-term scheduling. This depth of knowledge and exposure to many operating mines means he is capable of a very wide range of mining related tasks. Mark's skills and areas of expertise include mine scheduling, improvement studies, financial analysis and JORC Code Reserve reporting. Mark holds a Bachelor of Civil Engineering with First Class Honours, a Bachelor of Business and is a Member of the Australasian Institute of Mining and Metallurgy.

Richard Marshall | Associate Consultant | Processing

Richard is an Associate Coal Process Engineer with over 18 years' experience in engineering and project management companies providing services from conceptual through to detailed engineering, construction, commissioning and operations support in the Australian and African coal industries. Richard has recently worked with Forge/Taggart and Ausenco managing large CHPP option studies to deliver cost effective results, and including EPCM work on the construction of coal plants.

Shaun Barry | Associate Consultant | Corporate Advisory

Shaun has a commercial and geological background with over 24 years of experience in sales, marketing, commodity analysis, equity analysis, strategy development, and geology gained in platinum group metals, gold, coal, base metals, bauxite, and alumina. As a corporate consultant, he specialises in mineral asset valuations, market reviews of mineral commodities, and country reviews. Shaun also specialises in corporate strategy development that supports the preparation of Competent Persons Reports for equity transactions and Independent Technical Reports for project finance and mineral asset valuations. Shaun holds a Master of Science in Mineral Economics, a Bachelor of Science with Honours in Geology and a Diploma in Investment Management. He is a Member of the Australasian Institute of Mining and Metallurgy.

Graham Trusler | Associate Consultant | Environment

Graham Trusler is one of the founding members and CEO of Digby Wells Environmental. He has an M.Sc (Engineering) and B. Commerce. He is registered professional engineer with the Engineering Council of South Africa and the Institution of Engineers in Australia. He is also registered with the South African Institute of Chemical Engineers and is a member of the Water Institute of South Africa and the American Society of Mining and Reclamation. Graham has over 21 years experience as an environmental specialist in the mining industry and prior to that worked in metallurgical production. He has managed many environmental assessments, conducted due diligences in numerous countries and has done a significant amount of work in the region in which SAEC operates specific to coal mining.

Bradly Thornton | Associate Consultant | Environment

Bradly is the Divisional Manager of the Human Sciences Division at Digby Wells Environmental. He graduated with BSc(Hons) in the field of Geography and Environmental Management at Rand Afrikaans University. He has over seven years international experience as an environmental consultant. His key responsibilities at Digby Wells Environmental currently include but are not limited to: Management of Human Sciences Division; Quality Management and Review; Business development; and Project Director on Key Client projects. He has significant experience in coal mining projects, specifically in the region in which SAEC operates.

After inaugurating GIS technology at Digby Wells, expertise has further developed in the areas of Aerial Photographic and Satellite Remote Sensing applications, topographical and 3D data modelling, Hyperspectral Remote Sensing and other cartographic applications. Has a keen interest in identifying natural and social relationships, which lends itself to a better understanding of the environment and enhancing informed decision making.

13 References

13.1 Internal SAEC Documents

- SAEC, 2014, "SAEC Coal Processing LOA Plan Design Criteria", FY14.
- SAEC, 2014, "SAEC Coal Processing Performance Report" September 2014.
- SAEC, 2014, "SAEC Coal Processing Plant RFI's" November 2014.
- SAEC, 2014, "SAEC Commercial/Marketing" presentation to Xstract, October 2014.
- SAEC, 2014, "SAEC Delivery Appraisal Final with Hidden Slides_Feb2014" presentation to Xstract, November 2014.
- SAEC, 2014, "Energy Coal South Africa MER – Xstract Overview" presentation to Xstract, October 2014.
- SAEC, 2014, "SAEC Equipment List" presentation to Xstract, October 2014.
- SAEC, 2014, "SAEC FY15 Delivery Appraisal", February 2014.
- SAEC, 2014, "SAEC HSE Overview" presentation to Xstract, October 2014.
- SAEC, 2014, "SAEC Key Strategies" presentation to Xstract, October 2014.
- SAEC, 2014, "SAEC Klipspruit Reserves" presentation to Xstract, October 2014.
- SAEC, 2014, "SAEC Overview of SAEC Reserves" presentation to Xstract, October 2014.
- SAEC, 2014, "SAEC Presentation BCP Visit", 23 October 2014.
- SAEC, 2014, "SAEC Presentation – Magnetite Consumption South Eskom Plant", October 2014.
- SAEC, 2014, "SAEC Product Optimisation Results" presentation to Xstract, October 2014.
- SAEC, 2014, "SAEC Report – Magnetite Loss Report South Eskom Destoning Plant".
- SAEC, 2014, "SAEC Report – Recovery of Magnetite from Dilute Medium Circuit South Export Plant", May 2014.
- SAEC, 2014, "BCP_Overview_23102014" presentation to Xstract, October 2014.
- SAEC, 2014, "CHPP SAEC Coal Processing" presentation to Xstract, October 2014.
- SAEC, 2014, "Community Development Initiatives" presentation to Xstract, October 2014.
- SAEC, 2014, "Environmental Overview – Khutala" presentation to Xstract, October 2014.
- SAEC, 2014, "Khutala Mine Geology Overview" presentation to Xstract, October 2014.
- SAEC, 2014, "Khutala Mine Geology Overview" presentation to Xstract, October 2014.
- SAEC, 2014, "Middelburg Mine Overview" presentation to Xstract, October 2014.
- SAEC, 2014, "Middelburg Resource estimation process" presentation to Xstract, October 2014.
- SAEC, 2014, "Klipspruit Mine Resource" presentation to Xstract, October 2014.
- SAEC, 2014, Register of Environmental Authorisations.
- SAEC, 2014, "Community Development Initiatives presentation", October 2014.
- SAEC, 2013, "SAEC Closure Plan 2013".

- SAEC, 2011, "Progress Report by BHP Billiton Energy Coal South Africa Limited (previously Ingwe Collieries Limited in respect of the General Geology of the South Witbank Project Area" Internal report.
- SAEC. 2014, "Water and Power Supply" word document to Xstract, November 2014.
- SAEC, 2014, "Wolvekrans Mine Overview" presentation to Xstract, October 2014.
- SAEC, 2014, "Xstract Visit Khutala Mine" presentation to Xstract, October 2014.
- SAEC, 2014, "Competent Person Report for BHP Billiton Energy Coal South Africa (Operations) 30 June 2014.
- SAEC, 2013, "Khutala Colliery LOA Design Criteria – Mining FY2014"
- SAEC, 2013, "Middelburg Colliery LOA Design Criteria" – Mining FY2014"
- SAEC, 2013, "Wolvekrans Colliery LOA Design Criteria – Mining FY2014"
- SAEC, 2013, "Klipspruit Colliery LOA Design Criteria – Mining FY2014"
- SAEC, 2014, "BECSA –Valuation Life of Asset LoA FY15" presentation to Xstract, October 2014
- SAEC, 2014, "Wolvekrans – Middelburg Complex LOA FY15" presentation to Xstract, October 2014
- SAEC, 2014, "Klipspruit LOA FY15" presentation to Xstract, October 2014
- SAEC, 2014, "Khutala LOA FY15" presentation to Xstract, October 2014

13.2 Public documents

- Ages (Pty) Ltd, 2013, BHP Billiton: EMPR Consolidation Report for Middelburg Mine Complex.
- Ages (Pty) Ltd, 2012: BHP Billiton Energy Coal South Africa (SAEC) - Middelburg Mines: Water Management Plans, 22 November 2012.
- Bezuidenhout, W. and Hansen, A., 2014, "Klipspruit Extension Project (KPSX)" presentation to Xstract, October 2014.
- BP, 2014, "Statistical Review of World Energy", bp.com/statisticalreview, June 2014.
- Chadwick, R.W., 1982, "Recent productivity improvements in the surface coal mining industry in South Africa", Soc. Min. Eng. of AIME, First International SME-AIME Fall meeting, Honolulu Hawaii, Sept 4-9, 1982.
- Coffey Mining South Africa, 2010, "The Roodekop Project, Independent Competent Persons Report" Prepared on behalf of Universal Coal Plc.
- Digby Wells Environmental, 2014, "Environmental Authorisations for the Proposed Klipspruit Extension: Weltevreden Project", BHP2690, prepared by Digby Wells Environmental for SAEC, dated July 2014.
- Digby Wells Environmental, 2014, "Mining Right Application, Environmental Authorisations and Water Use Licence Application for the Proposed Klipspruit Extension: South Project: Draft Scoping Report", BHP1591, prepared by Digby Wells Environmental for SAEC, dated June 2014.
- Driver, A., Nel, J., Snaddon, K., Murray, K., Roux, D., Hill, L., et al. 2011, "Implementation Manual for Freshwater Ecosystem Priority Areas" Pretoria: WRC.
- Department of Water Affairs, 2004, "A practical field procedure for identification and delineation of wetlands and riparian areas", Pretoria: DWAF.

- "DMO Feasibility Study Chapter 5.3 Metallurgical Processing", August 2006.
- Eskom, 2012, Request for proposal for Utilisation of External Consultants to conduct Mining Engineering Projects in Conjunction with Eskom Resources, Public Tender submissions request.
- Dhanooklal, V., 2014, "Overview of SAEC tenements Status as well as South African Approval Process", presentation to Xstract, October 2014.
- Witbank Local Municipality, 2013, "2012/13 IDP".
- Falconer, K.W., 1990, "Spotlight on 100 years of coal mining in Witbank", Journal of the South African Institute of Mining and Metallurgy, April 1990.
- Ferrar, A., and Lotter, M. 2007, "Mpumalanga Biodiversity Conservation Plan Handbook", Nelspruit: MPTA.
- GEMECS, 2014, Weltevreden Model Review Report (GMXP14035 and 14037) (May 2014).
- GEMECS, 2014, Leandra Project Review Report (GMXP14044) (May 2014).
- Gemmell, G., Marasis, J., Visser, L., Maseko, P. and Thomson, I., 2014, "Competent Person Report for BHP Billiton Energy Coal South Africa (Operations) as at 30 June 2014 including Coal Resources and Reserves", Internal Report, SAEC.
- Golder Associates, 2013, "Determination of Khutala Block A and Portion 16 contribution to pit water make" Internal Report, SAEC..
- Haniff, N., 2014, "KPSX-Resource Characterisation", presentation to Xstract, October 2014.
- Haniff, N., 2014, "Leandra Resource Overview", presentation to Xstract, October 2014.
- Haniff, N., and Marasis, J., 2014, "Competent Person Report for Leandra North Project as at 30 June 2014 including Coal Resources and Reserves", Internal Report, SAEC.
- Haniff, N., and Marasis, J., 2014, "Competent Person Report for Leandra South Project as at 30 June 2014 including Coal Resources and Reserves", Internal Report, SAEC.
- Haniff, N., and Marasis, J., 2014, "Competent Person Report for Weltevreden Project as at 30 June 2014 including Coal Resources and Reserves", Internal Report, SAEC.
- Haniff, N., and Marasis, J., 2014, "Competent Person Report for Naudesbank Project as at 30 June 2014 including Coal Resources and Reserves", Internal Report, SAEC.
- Hodgson, 2010, "Mine water balance for Khutala Colliery" Internal report, SAEC.
- Hodgson, 2012, "Update of the mine-water balance for Middelburg Colliery" Internal report, SAEC.
- Jamasmie, C, 2014, "India poised to overtake China as world's largest coal consumer" Mining.com 6 October 2014.
- Jamasmie, C, 2014, "China's new coal import tax a disaster for Australian miners", Mining.com 10 October 2014.
- Jamasmie, C, 2014, "US sees drop in coal exports in 2014", Mining.com, 3 October 2014.
- JMA Consulting (Pty) Ltd, 2008, "Ground Water Inputs for the Klipspruit Project EMPR", Internal Report, SAEC
- JMA Consulting (Pty) Ltd, 2010, "Geohydrology Report Appendix 1" Internal Report, SAEC
- Joubert, C, 2011, "BHP Billiton Energy Coal South Africa (SAEC) Geological Report – Waterberg Prospecting Rights", Internal Report, SAEC.

- Pettit, D, Van Aardt, R and Hennessy, M, 2014, "Environmental Authorisation for the Klipspruit Extension: Weltevreden: Draft Scoping Report", BHP2690, prepared by Digby Wells Environmental for SAEC, dated August 2014.
- Pettit, D, Van Aardt, R and Hennessy, M, 2014, "Environmental Authorisation for the Klipspruit Extension: South: Draft Scoping Report", BHP1591, prepared by Digby Wells Environmental for SAEC, dated May 2014.
- Kara, S., 2014, "Wolvekrans Mine Resource Overview" presentation to Xstract, October 2014.
- Malvern, 2014, "Malvern Report – BHP Billiton North Plant – Magnetic Separators Audit", October 2014.
- Mucina, L., and Rutherford, M., 2006, "The vegetation of South Africa, Lesotho and Swaziland" Pretoria: South African National Biodiversity Institute.
- Ndolvu, T., 2014, "Klipspruit Orientation" presentation to Xstract, October 2014.
- NSS., 2012, "SAEC Middelburg Complex Biodiversity Summary and Gap Analysis Report", Gauteng.
- Patterson, A., 2014, "Leandra Project - MER", presentation to Xstract, October 2014.
- Phola, 2014, "Phola Spreadsheet – 6-7 Phola Minerals Expert Report Opex Capex", October 2014.
- Phola, 2014, "Phola Presentation – Phola Plant Overview", 21 October 2014.
- Phola, 2014, "Phola Spreadsheet – 8 Monthly Performance".
- Phola, 2014, "Phola Presentation – Phola Plant Overview", October 2014.
- SANS 10320:2004, 2004, (Edition 1), South African National Standard: "South African guide to the systematic evaluation of coal resources and coal reserves", published by Standards South Africa, a division of the South African Bureau of Standards (SABS).
- Saunders, A., 2014, "China's own say no coal tariff free pass", The Australian Financial Review, 13 October 2014.
- Spalding, D.A., 1994, "An evaluation of the potential future supply of coal exports from South Africa", MP(Energy Studies) [Unpublished] Rand Afrikaans University. Retrieved from: <https://ujdigispace.uj.ac.za> (accessed 3 November 2014).
- Tati, B.B., 2011, "Multi-seam Coal Mining" Journ. SAIMM, Vol 11, April 2011, Page 231 – 242, (downloaded from <<<http://www.saimm.co.za/Journal/v111n04p231.pdf>>> on 17 October 2014).
- Tankard, AJ, Jackson, MPA, Eriksson, KA, Hobday, DK, Hunter DR, and Minter, WEL, 1982 "Crustal Evolution of Southern Africa, 3.8 billion years of Earth's History", Springer-Verlag, New York.
- Van Heerden, P. S., 2014, "Phola Coal Processing Plant", presentation to Xstract, October 2014.
- Wood Mackenzie, 2013, "Industry Report for Linc Energy", Report prepared for Linc Energy, Final offering Document with the Monetary Authority of Singapore, November 2013.
- World Energy Council, 2013, "World Energy Resources: Coal, 2013".

14 Glossary

2D	Two dimensional
3D	Three dimensional
Ash	Inorganic material remaining after combustion.
Beneficiation	The process of physically separating ore from gangue prior to subsequent processing of the beneficiated ore.
Brownfield	An exploration or development project located within an existing mineral province, which can share infrastructure and management with an existing operation.
Coal Reserves	The same meaning as Ore Reserves, but specifically concerning coal.
Coking coal	Used in the manufacture of coke, which is used in the steelmaking process by virtue of its carbonisation properties. Coking coal may also be referred to as metallurgical coal.
Competent Person	A minerals industry professional who is a Member or Fellow of The Australasian Institute of Mining and Metallurgy, or of the Australian Institute of Geoscientists, or of a 'Recognised Professional Organisation' (RPO), as included in a list available on the JORC and ASX websites. These organisations have enforceable disciplinary processes, including the powers to suspend or expel a member. A Competent Person must have a minimum of five years' relevant experience in the style of mineralisation or type of deposit under consideration and in the activity that the person is undertaking (JORC Code, 2012).
Cut-off grade	A nominated grade above which is defined an Ore Reserve or Mineral Resource. For example, the lowest grade of mineralised material that qualifies as economic for estimating an Ore Reserve.
Carboniferous	A geological period extending from 359 to 299 million years ago.
Energy coal	Used as a fuel source in electrical power generation, cement manufacture and various industrial applications. Energy coal may also be referred to as steaming or thermal coal.
Graben	A depressed block bordered by parallel faults
Grade	Any physical or chemical measurement of the characteristics of the material of interest in samples or product.
Greenfield	The development or exploration located outside the area of influence of existing mine operations/infrastructure.
Jurassic	A geological period extending from 201 to 145 million years ago.
Kriging	A geostatistical method of estimating resources based on a mathematical function known as a semivariogram.
LOI (Loss on ignition)	A measure of the percentage of volatile matter (liquid or gas) contained within a mineral or rock. LOI is determined to calculate loss in mass during pyroprocessing.
Marketable Coal Reserves	Represents beneficiated or otherwise enhanced coal product where modifications due to mining, dilution and processing have been considered, must be publicly reported in conjunction with, but not instead of, reports of Coal Reserves. The basis of the predicted yield to achieve Marketable Coal Reserves must be stated (JORC Code, 2012).
Metallurgical coal	A broader term than coking coal, which includes all coals used in steelmaking, such as coal used for the pulverised coal injection process.
Modifying	Considerations used to convert Mineral Resources to Ore Reserves. These include, but are not restricted to, mining, processing, metallurgical, infrastructure, economic,

Factors	marketing, legal, environmental, social and governmental factors.
Ore Reserves	The economically mineable part of a Measured and/or Indicated Mineral Resource. It includes diluting materials and allowances for losses, which may occur when the material is mined or extracted and is defined by studies at Pre-Feasibility or Feasibility
Permian	A geological period extending from 299 to 251 million years ago.
Practical Yield	The yield after plant yield discounting factors are applied to the borehole yield.
Probable Ore Reserves	Reserves for which quantity and grade and/or quality are computed from information similar to that used for proved reserves, but the sites for inspection, sampling, and measurement are farther apart or are otherwise less adequately spaced. The degree of assurance, although lower than that for proved reserves, is high enough to assume continuity between points of observation.
Proved Ore Reserves	Reserves for which quantity and grade and/or quality are computed from information similar to that used for proved reserves, but the sites for inspection, sampling, and measurement are farther apart or are otherwise less adequately spaced. The degree of assurance, although lower than that for proved reserves, is high enough to assume continuity between points of observation.
Reserve life	Current stated Ore Reserves estimate divided by the current approved nominated production rate as at the end of the financial year.
Run of mine product	Product mined in the course of regular mining activities.
Tailings	Those portions of washed or milled ore that are too poor to be treated further or remain after the required metals and minerals have been extracted.
Theoretical Yield	The yield for a specific export product specification as determined from borehole core samples
Total Coal Reserves	Run of mine reserves as outputs from the mining activities.
Triassic	A geological period extending from 250 to 200 million years ago.

Appendix A: SAEC's BEE Audit Certificate

Figure A.1: SAEC's BEE Audit Certificate



b
h
p
b
i
l
l
i
t
o
n
e
r
g
y
c
o
a
l
s
o
u
t
h
a
f
r
i
c
a
l
i
m
i
t
e
d
1
9
6
3
0
0
5
3
7
0
6
4
8
5
0
2
0
4
5
5
5
g
e
n
1
1
6
g
g
6

MEASURED ENTERPRISE	
Company Name	BHP Billiton Energy Coal South Africa Limited
Trade Name	BHP Billiton Energy Coal South Africa Limited
Location	Emalahleni, Mpumalanga
Registration Number	1963/000537/06
VAT Number	4850204555
Certificate Number	GEN 11698 REV1

B-BBEE SCORE PER ELEMENT	
Equity Ownership	11.71
Management Control	7.30
Employment Equity	3.61
Skills Development	10.68
Preferential Procurement	17.06
Enterprise Development	15.00
Socio Economic Development	5.00

B-BBEE STATUS	
B-BBEE Recognition Level	100 %
B-BBEE Status	Level 4 Contributor
Black Ownership	18.62 %
Black Female Ownership	0.71 %
Value Added Supplier	No
Enterprise Development Beneficiary	No
Beneficiary Category	N/A
Applicable Scorecard	Generic Scorecard
Applicable BEE Code	Gazette Codes 29617
Verification Date	11-March-2014
Expiry Date	10-March-2015





Ebrahiem Mohamed
Verification Manager



NERA is a SANAS Accredited Verification Agency. NERA has assessed and verified the relevant B-BBEE Elements of the above mentioned enterprise, to provide an independent and impartial opinion on the B-BBEE status of the enterprise, based on the Broad-Based BEE Codes of Good Practice (Codes 000-800).

www.nerasa.co.za
National Empowerment Rating Agency (Pty) Ltd Reg. 2005/041665/07

Source: BHP Billiton

Appendix B: Schedule of Mineral and Surface Rights

Table B.1: Summary of ownership and tenure for SAEC's Wolvekrans-Middelburg assets

Project	Farm Name & No.	Portion No.	Area (ha)	Holder	Licence type	Licence Number	Issued	Expiry	Surface Rights
Wolvekrans (Albion)	Kromfontein 30 IS	MA3 (Ptn of MA1) on RE of Ptn 2 MA4 (Ptn of MA2) on Ptn 8	1,182.3285	SAEC (100%)	Mining	MP30/5/1/2/2/377MR	11/10/2011	10/10/2041	
	Middeldrift 42 IS	MA4 (Ptn of MA2) on Ptn 8 MA4 MA4 (Ptn of MA3) (being former Ptn7) MA5 (Ptn of MA1)							Ptn15, Ptn11
	Rietfontein 43 IS	4 (Ptn of Ptn1) RE of Ptn1							RE of Ptn14, RE of Ptn2, RE of Ptn4 (Ptn of Ptn3)
	Vaalkranz 29 IS	MA6							
Wolvekrans (Douglas Proper)	Boschmanskrans 22 IS	Ptn of Ptn6, 7 (Ptn of Ptn4), Ptn of Ptn8 (Ptn of Ptn4), Ptn of Ptn8 (Ptn of Ptn4), ptn of Ptn9, Ptn of Ptn9, Ptn of RE3, Ptn of RE3, RE MA1, RE4, Ptn of RE of the farm	13,347.1025	SAEC (84%)/Tavistock Collieries (Pty) Ltd (16%)	Mining	MP30/5/1/2/2/376MR	2/12/2011	1/12/2041	Ptn5, Ptn7 (Ptn of Ptn4), Ptn9 (Ptn of Ptn4), RE of Ptn4, RE of farm, Ptn8 (Ptn of Ptn4), RE of Ptn3.
	Enkeldebosch 20	Ptn of RE5 (surface description is PTNs5 & 14)							Ptn32 (Ptn of Ptn14), Ptn35 (Ptn of Ptn14)
	Kleinkopje 15	MA5 (Ptn of MA4), MA6 (Ptn of MA3), MA7 (Ptn of MA1), Ptn of MA8 (Ptn of (MA2)), Ptn of MA8 (Ptn of (MA2)), Ptn of MA8 (Ptn of (MA2)), 12 (Ptn of Ptn 4), 13 (Ptn of Ptn4), Ptn of RE4, Ptn of RE4							RE of Ptn4
	Klippan 332	MA2 of Ptn10 (Ptn of Ptn1)							
	Naaupoort 335	RE MA1							Ptn166, Ptn167, Ptn 173
	Steenkoolspruit 18	5 (Ptn of Ptn1), RE1, Ptn of Ptn2, Ptn of Ptn2, Ptn S2 of 2, Ptn S1 of Ptn 2							Ptn2, Ptn5 (Ptn of Ptn1)
	Vandyksdrift 19	MA2 (Ptn of MA1), 4 (Ptn of Ptn3), 5 (Ptn of Ptn3), 6 (Ptn of Ptn3), 7 (Ptn of Ptn3), RE MA1, RE1, Ptn of RE3, Ptn of RE3							Ptn12 (Ptn of Ptn2), Ptn13 (Ptn of Ptn2), RE of Ptn1, Ptn10 (Ptn of Ptn3), Ptn11 (Ptn of Ptn3), Ptn9, RE of Ptn3
	Vlaklaagte 21	Ptn of RE MA1							Ptn4 (Ptn of Ptn1), RE of Ptn1, Ptn5 (Ptn of Ptn1), RE of farm, Ptn3 (Ptn of Ptn1), Ptn2
	Welverdiend 23	MA2 (Ptn of MA1), 2, Ptn of Ptn5, Ptn of Ptn5, 6, 7, 9, Ptn of RE1, RE							Ptn19
	Wolvekrans 17	Ptn of Ptn10 (Ptn of Ptn2), Ptn of Ptn13							Ptn9 (Ptn of Ptn2), Ptn21, Ptn5 (Ptn of

Project	Farm Name & No.	Portion No.	Area (ha)	Holder	Licence type	Licence Number	Issued	Expiry	Surface Rights
		(Ptn of Ptn2), 17 (Ptn of Ptn4), 18 (Ptn of Ptn4), 20 (Ptn of Ptn4), Ptn of Ptn35, 5 (Ptn of Ptn1), 9 (Ptn of Ptn2), RE3, RE4 (Ptn of Ptn3), RE6 (Ptn of Ptn1), Ptn of MA2/RE, Ptn of MA2/RE							Ptn1, RE of Ptn3, RE of Ptn4 (Ptn of Ptn3), RE of Ptn6 (Ptn of Ptn1), RE of farm, Ptn 10 (Ptn of Ptn2), Ptn 13 (Ptn of Ptn2), Ptn 35
Wolvekrans (Kleinkopje)	Kleinkopje 15 IS	Ptn of RE4 Ptn of Ptn6 Ptn of RE8 RE of MA1 on Ptn9 RE of MA3 on Ptn14 (Ptn of Ptn4) RE of MA4 on RE of the farm	572.6180	SAEC (84%)/Tavistock Collieries (Pty) Ltd (16%)	Mining	MP30/5/1/2/2/378MR	27/10/2011	26/10/2041	Wolvekrans (Kleinkopje)
Middelburg	Bankfontein 340 JS	MA4 (MA1) 19 (Ptn of Ptn 15) 4 (Ptn of Ptn1) RE MA2 on Ptn 14 RE15 (Ptn of Ptn13)	18,938.0590	SAEC (84%)/Tavistock Collieries (Pty) Ltd (16%)	Mining	MP30/5/1/2/2/379MR	2/12/2011	1/12/2041	Ptn25, Ptn27 (Ptn of Ptn13), Ptn14 (Ptn of Ptn13), Ptn16 (Ptn of Ptn4), Ptn19 (Ptn of Ptn15), RE of Ptn15 (Ptn of Ptn13), RE of Ptn4 (Ptn of Ptn1)
	Boschmanskrans 22 IS	1, 12 (Ptn of Ptn 3) Ptn of Ptn6 Ptn of Ptn8 Ptn of RE3 Ptn of RE							Ptn1, Ptn6, Ptn8 (Ptn of Ptn4), RE of Ptn3
	Driefontein 338 JS	5 (Ptn of Ptn2) 6 (Ptn of Ptn2) 7 (Ptn of Ptn2) RE1, RE2, RE3 (Ptn of Ptn1), RE4 (Ptn of Ptn1)							Ptn11 (Ptn of Ptn10), Ptn7 (Ptn of Ptn4), RE of Ptn1, RE of Ptn4 (Ptn of Ptn1), RE of Ptn10, Ptn5
	Goedehoop 315 JS	11 (Ptn of Ptn9) (Dagbreek) Ptn of Ptn13 (Dagreek) (Ptn of Ptn 10), RE1, RE10 (Dagbreek) (Ptn of Ptn9), RE9, 34							RE of Ptn13 (Dagreek) (Ptn of Ptn10), Ptn34, Ptn 35, Re of Ptn5 (Ptn of Ptn3), Ptn26 (Ptn of Ptn11), Ptn25 (Ptn of Ptn11), Ptn28 (Ptn of Ptn11), Ptn29 (Ptn of Ptn11), Ptn27 (Ptn of Ptn11), Ptn30 (Ptn of Ptn11), RE of Ptn11 (Ptn of Ptn9), Ptn31 (Ptn of Ptn11), RE of Ptn9, RE of Ptn10 (Dagbreek (Ptn of Ptn9)
	Hartbeestfontein 339 JS	MA3(Ptn of MA2), 6 (Ptn of Ptn1), 8, 9, RE10, RE							Ptn16 (Ptn of Ptn3), Ptn6 (Ptn of Ptn1), Ptn 9, RE of Ptn10, RE of Ptn8, RE of farm, Ptn 15 (Ptn of Ptn2)
	Klipfontein 316 JS	MA3 (Ptn of MA1 on							Ptn1, Ptn2, RE of

Project	Farm Name & No.	Portion No.	Area (ha)	Holder	Licence type	Licence Number	Issued	Expiry	Surface Rights
		RE2), MA4							Farm
	Klipfontein 470	1,2 RE							
	Rondeboschje 468 JS	2, RE MA1 on Ptn1, RE							Ptn1, Ptn2, RE of farm
	Speekfontein 336	1, 10 (Ptn of Ptn3), 11 (Ptn of Ptn3), 14 (Ptn of Ptn3), 5 (Ptn of Ptn3), RE3							Ptn5 (Ptn of Ptn3)
	Sterkwater 317 JS	3, RE							Ptn4 (Ptn of Ptn2)
	Vaalbank 289 JS	Ptn of Ptn3							
	Vlakraagte 21	Ptn of RE MA1							Ptn3 (Ptn of Ptn1), Ptn2
	Wolvekrans 17	Ptn of Ptn10, Ptn of Ptn13 (Ptn of Ptn2), 12 (Ptn of Ptn2), 15 (Ptn of Ptn2), 16 (Ptn of Ptn2), Ptn of Ptn35, RE2							Ptn15 (Ptn of Ptn2), Ptn10 (Ptn of Ptn2), Ptn13 (Ptn of Ptn2), Ptn14 (Ptn of Ptn2), Ptn16 (Ptn of Ptn2), RE of Ptn2, Ptn 35
	Wolvenfontein 471 JS	5, RE1							Ptn 5 (Ptn of Ptn3), RE of Ptn1

MA= Mining Area, RE = Remaining Extent, Ptn= portion

Table B.2: Summary of ownership and tenure for SAEC's Klipspruit Mine

Project	Farm Name & No.	Portion No.	Area (ha)	Holder	Licence type	Licence Number	Issued	Expiry	Surface Rights
Klipspruit	Bankfontein 216	MA6, RE of MA4	2,165.3104	SAEC (100%)	Mining	MP30/5/1/2/2/125MR	11/10/2011	10/10/2041	Ptn17
	Klipfontein 3	Ptn of RE of MA2							Ptn19, Ptn13, RE of Ptn14, RE of Ptn12, Ptn37 (Ptn of Ptn12), Ptn38 (Ptn of Ptn 12), Ptn41 (Ptn of Ptn39)
	Oogiesfontein 4 Prinshof 2	MA3, Ptn of Ptn55 Ptn of RE of MA12, Ptn of RE of Ptn2							RE of Ptn14
	Smaldeel 1	MA2, MA6 (Ptn of MA5), Ptn of MA4 (Ptn of MA3), Ptn of RE of MA3, Ptn of RE of MA5, RE of MA1 on Ptn1							RE of Ptn2, RE of Ptn1, Ptn4, Ptn11

MA= Mining Area, RE = Remaining Extent, Ptn= portion

Table B.3: Summary of ownership and tenure for SAEC's Khutala Mine

Project	Farm Name & No.	Portion No.	Area (ha)	Holder	Licence type	Licence Number	Issued	Expiry	Surface Rights
Khutala	Bombardie 36	MA1 (excluding 2 & 4 seam in an area measuring 48.3456 ha)	9,321.1455	SAEC (100%)	Mining	MP30/5/1/2/2/118MR	11/10/2011	10/10/2041	
	Cologne 34	The Farm							Ptn3, Ptn4 (Ptn of Ptn1)
	Leeuwfontein 219	RE of the farm							Ptn35
	Smithfield 44	MA1 on Ptn4, Ptn 6, Ptn7, RE of the farm							Ptn8, Ptn6, Ptn7, RE of farm
	Schoongezicht 218	MA1 of Ptn15, MA2 on RE of Ptn14, MA3 on Ptn15, MA6 on Ptn18, MA7 on Ptn8, MA9 on Ptn3, Ptn12, Ptn16, Ptn19, Ptn20, Ptn5, Ptn7, Ptn9, RE of Ptn11, RE of Ptn4, Re of Ptn6, RE of the farm							Ptn16 (Ptn of Ptn6), Ptn32 (Ptn of Ptn30), Ptn16 (Ptn of Ptn6), Ptn40 (Ptn of Ptn3)
	Springboklaagte 33	Ptn12, Ptn16, Ptn3, Ptn9, RE of Ptn2							
Zondagsflei 9	Ptn10, Ptn11, Ptn12, Ptn13, Ptn14, Ptn15, Ptn16, Ptn2, Ptn6, Ptn7, Ptn8, Ptn9, RE of Ptn4, RE of Ptn5, RE of the Farm								Ptn16 (Ptn of Ptn3), RE of Ptn4, RE of farm, Ptn 15 (Ptn of Ptn3), Ptn19 (Ptn of Ptn4), Ptn21, Ptn9 (Ptn of Ptn3), Ptn14 (Ptn of Ptn3), Ptn18 (A ptn of Ptn2), Ptn7 (Ptn of Ptn5), Ptn8 (Ptn of Ptn3), Ptn17 (Ptn of Ptn3), RE of Ptn2

MA= Mining Area, RE = Remaining Extent, Ptn= portion

Table B.4: Table of tenure rights for Weltevreden

Project	Farm Name & No.	Portion No.	Area (ha)	Holder	Licence type	Licence Number	Issued	Expiry	Surface Rights
Weltevreden	Weltevreden 324 JS	MA2 (Ptn of MA1), Ma4 (Ptn of MA3) on Ptn6 (Ptn of Ptn2), Ptn3, Ptn4, Ptn7 (Ppt of MA1)	4,499.3240	SAEC (100%)	Prospecting	MP30/5/1/1/2/1058PR	17/08/2006	16/08/2011 – renewal lodged	
	Hartbeeslaagte 325 JS	MA2 (Ptn of MA1) on Ptn1, MA3 on RE of Ptn2, Ptn3 (Ptn of Ptn2), Ptn37 (Ptn of Ptn2), Ptn40, RE of Ptn1, Ptn39							RE of Ptn1, Ptn39
	Tweefontein 328 JS Wildebeestfontein 327 JS	Ptn3, Ptn4, RE MA2 (Ptn of MA1), RE of Ptn1, RE of farm.							Ptn38, Ptn15 (Ptn of Ptn8), RE of Ptn1, RE of Ptn8, Re of farm RE of Ptn10 (Ptn of Ptn9), RE of Ptn2.
	Prinshof 2 IS	Ptn of RE of MA12, RE of MA11 on Ptn1, Ptn of RE of Ptn2							
Weltvreden (Grootpan)	Grootpan 7 IS	Ptn3 (Ptn of Ptn2), Ptn5 (Ptn of Ptn2), Ptn6 (Ptn of Ptn2), RE of Ptn2, RE of Ptn21 (Ptn of Ptn7), RE of Ptn4 (Ptn of Ptn2)	1,308.8309	SAEC (100%)	Prospecting	MP30/5/1/1/2/1028PR	17/08/2006	11/08/2011 – renewal lodged	
	Zaaiwater 11 IS	RE of Ptn5							
Weltvreden (Tweefontein)	Tweefontein 328 JS	Ptn8 (Ptn of Ptn5, RE of Ptn1, RE of Ptn5 (Ptn of Ptn1), RE of Ptn6 (Ptn of Ptn1).	1,519.5606	SAEC (100%)	Prospecting	MP30/5/1/1/2/21PR	6/08/2010	11/08/2015	

MA= Mining Area, RE = Remaining Extent, Ptn= portion

Table B.5: Table of tenure rights for Leandra

Project	Farm Name & No.	Portion No.	Area (ha)	Holder	Licence type	Licence Number	Issued	Expiry	Surface Rights
Leandra (Gauteng)	Groenkuil 321	Ptn1	1,433.7487	SAEC (100%)	Prospecting	GP30/5/1/1/2/223PR	30/01/2007	29/01/2012 – renewal lodged	Leandra (Gauteng)
	Groenkuil 318	Farm							
	Honigfontein 339	RE, Ptn10, Ptn4 (Ptn of Ptn1), Ptn5 (Ptn of Ptn1), Ptn6 (Ptn of Ptn1), Ptn7, Ptn8, RE of Ptn1							
	Leeuwkop 229	Ptn4 (Ptn of Ptn2), Ptn5 (Ptn of Ptn2)							
	Nooitgedacht 294	MA2 (Ptn of MA1) on Ptn28, Ptn12, Ptn17 (Ptn of Ptn2), Ptn18 (Ptn of Ptn2), Ptn23 (Ptn of Ptn19), Ptn29 (Ptn of Ptn26), Ptn8, Ptn9,							
	Palmiefontein 316	RE of Ptn1, Ptn10 (Ptn of Ptn2), Ptn13 (Ptn of Ptn2), Ptn16 (Ptn of Ptn1), Ptn19 (Ptn of Ptn3), Ptn21 (Ptn of Ptn3), Ptn22 (Ptn of Ptn4), Ptn23 (Ptn of Ptn18), Ptn24 (Ptn of Ptn18), Ptn25 (Ptn of Ptn18), Ptn26 (Ptn of Ptn18), Ptn28 (Ptn of Ptn6), Ptn29 (Ptn of Ptn12), Ptn31 (Ptn of Ptn3), Ptn5 (Ptn of Ptn1), Ptn7 (Ptn of Ptn6), Ptn8 (Ptn of Ptn4), RE of Ptn12 (Ptn of Ptn2), RE of Ptn15 (Ptn of Ptn1), RE of Ptn18 (Ptn of Ptn3), RE of Ptn2, RE of Ptn4 (Ptn of Ptn1)							
	Palmietkuil 322	MA1 on Ptn14, MA2 on Ptn15, MA3 on Ptn4, Ptn10, Ptn11, Ptn7, RE of farm							
	Winterhoek 314	Ptn12 (Ptn of Ptn5), Ptn3, Ptn4, RE of Ptn2, RE of Ptn5, RE of Ptn6							
	Wonderfontein 342	The Farm							
	Zeerkry 292	RE							
Leandra (Mpumalanga)	Couwenburg 300	RE of farm, Ptn1, RE of ptn2, Ptn3 (Ptn of Ptn2), RE of Ptn4 (Ptn of Ptn2), Ptn5 (Ptn of Ptn4), Ptn6	38,144.7065	SAEC (100%)	Prospecting	MP30/5/1/1/2/1151PR	28/09/2012	27/09/2015	Leandra (Mpumalanga)
	Goedehoop 290	Farm							
	Goedgemeend 519	RE, Ptn2							
	Grootlaagte 353	Ptn5							
	Grouwwater	Ptn3, RE of Ptn4, Ptn5 (Ptn of Ptn4), Ptn6 (Ptn of Ptn4)							
	Gruisfontein 344	The Farm							
	Kafferskuilen 349	The Farm							
Kafferspruit 527	RE of Ptn1, RE of Ptn2, Ptn3 (Ptn of Ptn2), RE of Ptn4, Ptn6, RE of MA1 on Ptn7, MA2 (Ptn of MA1), MA3 on Ptn11, MA6 (Ptn of MA4), MA7 (Ptn of MA5) on Ptn12 (Ptn of Ptn1), Ptn13 (Ptn of Ptn2)								

Project	Farm Name & No.	Portion No.	Area (ha)	Holder	Licence type	Licence Number	Issued	Expiry	Surface Rights
	Klipfontein 357	RE of the Farm, RE of Ptn2 (Ptn of Ptn1), Ptn3							
	Kuilwater 347	The Farm							
	Lanseria 514	Ptn1							
	Leeuwbank 512	MA1 on Ptn4 (Ptn of Ptn1)							
	Paardefontein 526	Ptn4, RE of Ptn5, Ptn6 (Ptn of Ptn5), Ptn7 (Ptn of Ptn5), Ptn8 (Ptn of Ptn5), Ptn9 (Ptn of Ptn5)							
	Rietkeuil 531	RE of Ptn2, Ptn3 (Ptn of Ptn1), Ptn5 (Ptn of Ptn2), Ptn9 (Ptn of Ptn2), Ptn10 (Ptn of Ptn2)							
	Rolspruit 127	Ptn2, Ptn6, Ptn9, Ptn10, Ptn11, Ptn7 (Ptn of Ptn1)							
	Saltpeterkranz 351	Ptn7 (Ptn of Ptn1)							
	Springboklaagte 306	RE of Farm, RE of Ptn1, RE of Ptn3, Ptn6 (Ptn of Ptn3)							
	Vlakplaats 348	RE, Ptn3, RE of MA1, MA2 (Ptn of MA1)							
	Watervalshoek 350	RE, Ptn1, RE of Ptn3, RE of Ptn5, RE of Ptn6, Ptn7 (Ptn of Ptn6), Ptn10 (Ptn of Ptn8), RE of Ptn14, Ptn26 (Ptn of Ptn4), Ptn29 (Ptn of Ptn14), Ptn30 (Ptn of Ptn14), Ptn31 (Ptn of Ptn14), Ptn32 (Ptn of Ptn14), RE of Ptn35, Ptn36 (Ptn of Ptn35), Ptn45 (Ptn of Ptn5)							
	Wildealskraal 518	RE of Ptn2, Ptn4 (Ptn of Ptn2), Ptn9 (Ptn of Ptn2), Ptn10 (Ptn of Ptn3), Ptn11 (Ptn of Ptn3)							
	Wildebeestspruit 356	RE, RE of Ptn1, Ptn2, Ptn3, Ptn4							
	Witbank 340	RE of Ptn1, Re of Ptn2, MA2 on RE of Ptn3, MA3 on RE of Ptn3, Ptn8 (Ptn of Ptn4), Ptn9 (Ptn of Ptn4), Ptn10 (Ptn of Ptn4), Ptn11 (Ptn of Ptn4), Ptn12 (Ptn of Ptn4), MA1 on Ptn13, MA8 on Ptn13 (Ptn of Ptn3), MA5 (Ptn of MA4) on RE of Ptn14, MA5 on RE of Ptn14, MA6 (Ptn of MA11), MA6 on RE of Ptn14, MA7 on RE of Ptn14, Ptn15 (Ptn of Ptn14), Ptn marked AdEFA on SG A,347/30 of Ptn16, Ptn marked dBCDEd on diagram SG No A 347/30 of Ptn16, Ptn17 (Ptn of Ptn14), MA9 (Ptn of MA11), MA10 (Ptn of MA11), Re of MA11							
	Wonderfontein 341	RE of Ptn1, RE of Ptn2 (Ptn of Ptn1), Ptn3 (Ptn of Ptn1), Ptn4 (Ptn of Ptn1), Ptn5 (Ptn of Ptn1), Ptn6 (Ptn of Ptn1), Ptn7 (Ptn of Ptn2), RE of Ptn8 (Ptn of Ptn2), Ptn9, Ptn10, RE of							

Project	Farm Name & No.	Portion No.	Area (ha)	Holder	Licence type	Licence Number	Issued	Expiry	Surface Rights
Leandra (Balance of Delmas Mine)	Rietfontein 313 IR	Ptn11, RE of Ptn13 (Ptn of Ptn11), Ptn14 (Ptn of Ptn8), Ptn15 (Ptn of Ptn8), Ptn16 (Ptn of Ptn13)	3,769.3341	SAEC (100%)	Prospecting	MP30/5/1/1/2/418PR	28/09/2012	27/09/2015	Leandra (Balance of Delmas Mine)
	Holspruit 303 IR	Re of Farm, Ptn1							
	Steenkoolspruit 302 IR	Ptn6, Ptn of RE of the Farm							
	Enkeldehbosch 301 IR	Ptn2 (Sonderbos), Ptn3 (Ptn of Ptn1), RE of Ptn1 (Sonderbos), Ptn of RE of Farm							
Leandra (Winterhoek)	Winterhoek 314 IR	RE of Ptn1	827.0000	SAEC (100%)	Prospecting	GP30/5/1/1/2/59PR	12/11/2012	11/11/2015	Leandra (Winterhoek)
Leandra (Leeuwkop)	Leeuwkop 299 IR	Ptn of original Ptn6, RE of Ptn2, RE of Ptn3 (Ptn of Ptn1)	1,443.7493	SAEC (100%)	Prospecting	GP30/5/1/1/2/221PR	30/01/2007	29/01/2011 – renewal lodged	Leandra (Leeuwkop)

MA= Mining Area, RE = Remaining Extent, Ptn= portion

Table B.6: Table of tenure rights for Naudesbank

Project	Farm Name & No.	Portion No.	Area (ha)	Holder	Licence type	Licence Number	Issued	Expiry	Surface Rights
Naudesbank	Naudesbank 172 IS	Ptn8 (Ptn of Ptn3), MA1 on Ptn9, MA2 on Ptn9, Ptn2, RE of Ptn3 (Ptn of Ptn1), RE of Ptn1, RE of Ptn7 (Ptn of Ptn3), Ptn15 (Ptn of Ptn1), Ptn13 (Ptn of Ptn7)	9132.7093	SAEC (100%)	Prospecting	MP30/5/1/1/2/1057PR	16/08/2006	17/08/2011 – renewal lodged	Ptn15 (Ptn of Ptn1), Ptn10 (Ptn of Ptn2)
	Jagtlust 47 IT	Ptn of Farm							
	Kromkrans 208	RE of Ptn2							
	Steynsdraai 46 IT	MA2 (Ptn of MA1) on Ptn4, MA4 (ptn of MA3)							
	Vaalbult 3 IT	Ptn4, Ptn5, Ptn7, Ptn8, Ptn6, Ptn3							
	Vaalwater 173 IS	MA2 (Ptn of MA1), Ptn7 (Ptn of Ptn3), RE of Ptn3 (Eikendaal)							
	Twyfelaar 171 IS	Ptn3							

MA= Mining Area, RE = Remaining Extent, Ptn= portion

Appendix C: Environmental Authorisation Status

Table C.1: Wolvekrans Mine Environmental Authorisation status

Authorisation	Name	Date Approved	Expiry date	Environmental Order/ Directive issued	Reference number	Department
EMPRs	Permission to erect a washing plant complex within 100 metres from undermined ground.	1974/10/21	None specified	None	IM WIT 153/21/8	DMR (former-DME)
	Permission to dispose of waste material (slurry) from the coal preparation plant into the underground workings.	1983/05/26	None specified	None	IM WIT 87/21	DMR (former-DME)
	Approval of Dumping site: PSS Dump	1984/10/09	N/A	None	IM WIT 87/21	DMR (former-DME)
	Permission to dispose of waste material (slurry) from the coal preparation plant into the underground workings.	1985/05/30	2022/05/19	None	IM WIT 87/21	DMR (former-DME)
	Mining authorisation for various farms: Ingwe Collieries Limited (84%) and Tavistock Collieries Limited (16%) (Douglas Mine).	1999/05/20	2022/05/19	None	MR/TNC/B/D GC/154 (EW)	DMR (former-DME)
	Mining authorisation for various farms: Ingwe Collieries Limited (Douglas Mine).	1999/05/20	2022/05/19	None	MR/TNC/B/D GC/154 (EW)	DMR (former-DME)
	EMPR Approval: Boschmanskrans Openpit	2001/05/30	2022/05/19	None	OT 6/2/2/113	DMR (former-DME)
	EMPR Approval: Douglas Mine	2003/02/25	2022/05/19	None	OT 6/2/2/113	DMR (former-DME)
	EMPR Approval: Boschmanskrans Openpit	2001/05/30		None	OT 6/2/2/113	DMR (former-DME)
	EMPR Approval: Douglas Mine	2003/02/25		None	OT 6/2/2/113	DMR (former-DME)
EMPR Approval: Boschmanskrans Extension	2013/05/02	2047/05/02	None	MP/30/5/1/2/3/2/1 (376) EM	DMR (former-DME)	
EIA Authorisations	Exemption: Relocation of a power line on the farm Boschmanskrans 22-IS.	1999/06/17	N/A	None	14.1(H).2 (W)	DEA
	Diversions of the Boesmanskransspruit within the Boschmanskrans Section of Douglas Mine.	2000/05/09	N/A	None	14.9(H).5(W)	DEA

Authorisation	Name	Date Approved	Expiry date	Environmental Order/ Directive issued	Reference number	Department
	Authorisation for the extension of railway line and the construction of a new railhead at Douglas Mine.	2000/07/26	N/A	None	14.4(H).6 (W)	DEA
	Construction and installation of bulk above ground storage facilities for fuel, lubricants and waste oil.	2007/12/10	N/A	None	17/2/1/7 MP-1	DEA
	Installation of above ground storage tanks at Douglas Mine.	2010/02/10	N/A	None	17/2/1 © NK	DEA
	Installation underground petrol tank at Boschmanskrans section.	2004/09/15	N/A	None	17/2/4 NK 73	DEA
	Radio Masts	2009/05/08	N/A	None	17/2/1/14 MP-147	DEA
	Installation of additional High Energy Fuel (HEF) silos	2009/02/20	N/A	None	17/2/1/7 NK-1	DEA
	Establishment of one High Energy Fuel (HEF) and two Porous Prilled Ammonium Nitrate (PPAN) bulk storage facilities (silos)	2003/03/12	N/A	None	17/2/1/7 NK-2	DEA
	Section 24G Authorisation	2013/08/12	N/A	Fine paid	17/2/3 G NK 24	MDEDET
WULs	PSS discard dump extension WUL	2002/12/13	2012/12/13	None	24061131	DWS (former DWA)
	Douglas WUL (DMO)	2008/10/10	2028/10/10	None	24084535	DWS (former DWA)
	MMS IWUL	2010/01/14	2030/01/14	None	27/2/2/B81 1/101/8	DWS (former DWA)
	Douglas Mine Section 21(f) Pit 4A	2011/04/01	2014/04/01	None	27/2/2/B61 1/103/8	DWS (former DWA)
	Douglas Mine: Olifants River Backfill Project	2011/03/25	2013/03/25	None	24084535	DWS (former DWA)
	GA Temporary pipeline BMK	25/04/2013	N/A	None	16/2/7/B10 0/C23	DWS (former DWA)

Table C.2: Middelburg Mine Environmental Authorisation status

Authorisation	Name	Date Approved	Expiry date	Environmental Order/ Directive issued	Reference number	Department
EMPRs	Klipfontein EMPR	2004/02/18	N/A	None	MP/30/5/1/2/3/2/1(379) EM	DMR (former DME)
	Middelburg North listed under Wolvekrans Mine					
EIA Authorisations	Emulsion Silo Klipfontein (under Sasol)	2009/02/01	N/A	None		DEA
	High masts at Goedehoop	2009/02/01	N/A	None	17/2/14 MP-141	
WULs	Klipfontein WUL	2011/10/28	2034/10/28	None	04/B11H/CEG IJ/1153	DWS (former DWA)
	Middelburg North listed under Wolvekrans Mine					

Table C.3: Klipspruit Environmental Authorisation status

Authorisation	Name	Date Approved	Expiry date	Environmental Order/Directive issued	Reference number	Department
EMPs	Klipspruit Mine EMP	2003/06/01	2010/06/01	None	OT6/2/2/495	DMR (former-DME)
	Klipspruit Mine EMP amendment	2010/09/01	2034	Yes, incorrectly issued. Response for withdrawal sent to DMR.	MP30/5/1/2/1/(125)	DMR (former-DME)
EIA Authorisations	Klipspruit High energy Fuel Silo	20/01/2006	20/01/2009	None	17/2/4/NK 101	MDEDET
	Klipspruit Diesel tanks	2006/05/18	None	None	17/2/1 NK	MDEDET
	Klipspruit desalination plant	2011/02/01	2013/02/01	None	17/2/2/1p NK-1	MDEDET
EIA Applications Lodged	Klipspruit waste activities	Application submitted 2012	Not yet issued	None	17/2/3N-199	MDEDET
WULs	Klipspruit Mine WUL	2006/04/12	2026/04/12	None	16/2/7/B100/C186	DWS (former DWA)
	Phola Plant WUL	2012/05/02	2032/05/02	None	16/2/7/B100/C186	DWS (former DWA)
	Klipspruit Desalination Plant	2011/12/20	2015/12/20	None	16/2/7/B100/C186	DWS (former DWA)

Table C.4: Khutala Environmental Authorisation status

Authorisation	Name	Date Approved	Expiry date	Environmenta l Order/Directi ve issued	Reference number	Department
EMPRs	Khutala Southern Access EMP	2009/01/19	2033	None	OT6/2/2/192	DMR (former-DME)
	Khutala Mine Underground and Block I EMP	2003/04/22	2041	None	OT/2/2/192	DMR (former-DME)
	Block A EMP	2003/04/16	2012	None	OT/2/2/192	DMR (former-DME)
	Block A EMP Amendment including portion 16	2013/02/15	2035	None	MP30/5/1/2/2/118MR	DMR (former-DME)
EMPs APPLICATIONS LODGED	Khutala Mine Southern Access Extension Project	Pending with the Department		None	MP 30/5/1/2/2/18 MR	DMR (former-DME)
EIA Authorisations	Khutala Mine Air quality emission license	2014/05/31	2019/03/31	None	17\04\AEL\M P312\13\05	MDEDET
	Khutala Southern Access	2010/09/21	2014/09/21	21-Sep-14	17/2/2/1(e)M P-12	MDEDET
	Khutala Mine Southern Access Extension Project	2014/06/01	2019/06/01	None	17/2/3N-159	MDEDET
	Khutala Mine Block-A Portion 16	2012/11/22	2017/11/22	None	17/2/3N-137	MDEDET
EIA Applications Lodged	Block A Section 24G	Fine paid: May 2014, ROD still pending with MDEDET		None	17/03/01 NK 02/12	MDEDET
WULs	Khutala Southern Access WUL	2010/08/14	2020 (review every 5 yrs)	None	16/2/7/100/C 161	DWS (former DWA)
	Khutala Mine Block-A WUL	2011/09/14	2031 (review every 5 yrs)	None	16/2/7/B100/C304	DWS (former DWA)
	Khutala Mine Block-A Portion 16	2013/05/02	2030 (review every 2 yrs)	None	16/2/7/B200/C616	DWS (former DWA)
WULs APPLICATIONS LODGED	Khutala Mine Southern Access Extension Project	Pending with the Department		None	16/2/7/B100/C161	DWS (former DWA)

Appendix D: CESR Compliance Checklist

CESR Compliance Summary

CESR Item	CESR Contents	Report Item
131 (a)	Is the asset a material mineral project?	2.1; 5.1
131 (b)	Types of mineral projects – exploration, development, planning or production? Key products – processed ores (concentrates and tailings) and solid fuels (coal and peat)	2.1; 2.3; 2.4; 2.5; 5.1 4.1; 5.2.9; 5.3.8; 5.3.13; 5.4.11
131 (c)	Uncertainty as to the quantities of economically recoverable resources or technical feasibility of their recovery Uncertainty as to either the existence of the resources in the quantities required or the technical feasibility of their recovery	2.4.1; 2.5.1; 2.11; 4.7.2; 5.2.7; 5.2.16; 5.3.18; 5.4.14; 6.2.8 6.3.6; 6.4.5; 7.2
132 (a)	Details of mineral resources, and where applicable reserves (presented separately) and exploration results/prospects in accordance with one of more of the reporting standards that is acceptable under the codes and/or organisations set out in Appendix 1 (eg JORC/SAMREC and VALMIN/SAMVAL).	2.1, 2.3, 2.4, 2.5, 2.11, 2.12; 4.1,4.1.2, 4.5, 4.6;5.1,5.2, 5.2.5 to 7, 5.2.16; 5.3, 5.3.4 to 6; 5.4, 5.4.4 to 6, 5.4.14/15; 6.0, 6.2.6, 6.3.4, 6.4.4; 7.0,10.3.3, 10.4.3, 10.5.2, 10.9
132 (b)	Anticipated mine life and exploration potential or similar duration of commercial activities in extracting reserves	2.4, 2.4.1; 4.1.2; 5.2.3, 5.2.7; 5.3.2, 5.3.6/7; 5.4, 5.4.6, 6.2.4, 6.3.3, 6.4.2, 10.3.3
132 (c)	An indication of duration and main terms of any licences or concessions and legal, economic and environmental conditions for exploring and developing those licences or concessions	2.4, 2.8, 4.4, 5.2.1, 5.2.14, 5.3.1, 5.4, 6.2.3, 6.3.1, 6.4.1, 10.4.3, 10.7, 10.9
132 (d)	An indication of the current and anticipated progress of mineral exploration and/or extraction and processing including a discussion of the accessibility of the deposit.	2.1, 2.4, 2.5, 2.6, 2.11; 4.1, 4.1.2; 4.1.3; 4.2; 5.2.7, 5.2.8, 5.2.16, 5.3.6, 5.3.7, 5.4.6, 5.4.15; 6.1, 6.2.6, 7.0, 10.3.3, 10.4.2, 10.4.3, 10.5.2, 10.9
132 (e)	An explanation of any exceptional factors that have influenced (a) to (d) above.	2.11, 2.12, 4.1.2, 5.2.16, 5.3.17, 5.4.14, 6.2.9, 6.3.6, 6.4.5, 9.0
133 (i)(a)	Be prepared by an individual who: Either: (1) Possesses the required competency requirements as prescribed by the relevant codes/organisation (listed in Appendix 1); or (2) If such requirements are not prescribed by the code/organisation, then (3) Is professionally qualified and a member in good standing of an appropriate recognised professional association, institution or body relevant to the activity being undertaken and who is subject to the enforceable rules of conduct (4) Has at least five years' relevant professional experience in the estimation, assessment and evaluation of the type of mineral or fluid deposit being or to be exploited by the company and to the activity to which that person is undertaking; and (5) Is independent of the company, its directors, senior management and its other advisers; has no economic or beneficial interest (present or contingent) in the company or in any of the mineral assets being evaluated and is not	Letter, 3.6, 3.7.1, 3.8; 12.0

CESR Item	CESR Contents	Report Item
	remunerated by way of a fee that is linked to the admission or value of the issuer	
133 (i)(b)	Be dated not more than 6 months from the date of the prospectus provided the issuer affirms in the prospectus that no material changes have occurred since the date of the competent person's report the omission of which would make the competent person's report misleading	2.0
133 (i)(c)	Report mineral resources and where applicable reserves and exploration results/prospects in accordance with one or more of the reporting standards that is acceptable under the codes and/or organisations set out in Appendix I (Mining Reporting)	2.0, 2.3; 3.4; 4.6
133 (i)(d)	Contain information on the company's mineral projects segmented using a unit of account appropriate to the scale of its operations and prepared, in the case of a company with mining projects, having regard to Appendix II.	Letter, 2.1 to 2.12, 3.3, 4.0, 4.1,4.2, 4.4, 4.5, 4.7, 5.1, 5.2.1, 5.2.3 to 9, 5.2.13 to 16, 5.3,5.3.1 to 17,5.4, 5.4.1, 5.4.3 to 15, 6.0, 6.2.3 to 9, 6.3.1 to 6, 6.4.1, 6.4.3 to 5, 7.0, 8.1.6, 8.2, 9.0 to 2, 10.0, 10.3.1 to 3, 10.4.1 to 4, 10.5.1 to 2
133 (ii)	An issuer is exempt from including the Competent Person's report, if the issuer can demonstrate that: <ul style="list-style-type: none"> (1) Its equity securities are already admitted to trading on either a regulated market, an equivalent third country market, or an appropriate multi-lateral trading facility; and (2) It has reported and published annually details of its mineral resources and where applicable reserves (presented separately) and exploration results/prospects in accordance with one or more of the reporting standards set out in Appendix I for at least three years. 	N/A
133 (iii)	Information on mineral resources and where applicable reserves and exploration results/prospects as well as other information of a scientific or technical nature included in prospectuses outside of the competent person's report must not be inconsistent with the information contained in the competent person's report.	NEED TO CHECK OTHER PARTS OF PROSPECTUS
133 (iv)	Information required by any of these recommendations may be omitted if disclosure is prohibited by third country securities laws or regulations provided the issuer identifies the information omitted and law/regulations that prohibit disclosure.	Domestic Coal Prices with ESKOM not reported
157	When analysing whether an expert, who has produced a report included in the prospectus, has a material interest in the issuer, issuers are normally expected to consider the following circumstances related to the expert, among others: <ul style="list-style-type: none"> - ownership of securities issued by the issuer or by any company belonging to the same group or options to acquire or subscribe for securities of the issuer; - former employment of the issuer or any form of compensation from the issuer; - membership of any of the issuer's bodies; - any connections to the financial intermediaries involved in the offering or listing of the securities of the issuer. 	3.8
Appendix II (i)	Legal and Geological overview – a description of: <ul style="list-style-type: none"> (1) the nature and extent of the company's rights of exploration and extraction and a description of the properties to which the rights attach, with details of the duration and other principal terms and conditions of these rights including environmental obligations, and any necessary licences and consents including planning permission (2) any other material terms and conditions of exploration and extraction including host government rights and arrangements with partner companies 	4.1; 4.4 4.4.7; 5.2.2; 6.2.6
Appendix II (ii)	Geological Overview – a description of the geological characteristics of the properties, the type of deposit, its physical characteristics, style of mineralisation, including a discussion of any material geotechnical, hydro-geological/hydrological and geotechnical engineering issues	
Appendix II (iii)	Resources and reserves <ul style="list-style-type: none"> (1) a table providing data on (to the extent applicable): exploration results inclusive of commentary on the quantity and quality of this, inferred, indicated/measured resources, and proved/probable reserves and a statement regarding the 	2.3; 4.6; 5.2.5/6; 5.3.4/5; 5.4.4/5; 6.0; 7.0

CESR Item	CESR Contents	Report Item
	internationally recognised reporting standard used;	
	(2) description of the process followed by the competent person in arriving at the published statements and a statement indicating whether the competent person has audited and reproduced the statements, what additional modifications have been included, or whether the authors have re-verted to a fundamental re-calculation	3.2; 3.2.1; 4.6; 4.7
	(3) statement as to whether mineral resources are reported inclusive or exclusive of reserves	2.3; 4.6
	(4) supporting assumptions used in ensuring that mineral resource statements are deemed to be 'potentially economically mineable	2.3; 4.7; 6.2.6; 6.3.4; 6.4.4
	(5) supporting assumptions including commodity prices, operating cost assumptions and other modifying factors used to derive reserve statements	2.9; 5.2.15; 5.3.15; 5.4.15
	(6) reconciliations between the proposed and last historic statement	
	(7) a statement of when and for how long a competent person last visited the properties (or a statement that no visit has been made if that is the case)	3.2.1
	(8) for proved and probable reserves (if any) a discussion of the assumed:	
	(9) mining method, metallurgical processes and production forecast	2.4; 4.1.2; 5.2; 5.2.7; 5.3; 5.3.7; 5.4
	(10) markets for the company's production and commodity price forecasts	2.4; 8.1
	(11) mine life	2.4; 4.1.2; 5.2.7; 5.3.7; 5.4.7
	(12) capital and operating cost estimates	2.9; 5.2.15; 5.3.15; 5.3.16; 5.4.15
Appendix II (iv)	Valuation of reserves – taking consideration of internationally recognised valuation codes as set out in Appendix I a valuation of reserves comprising:	10.1
	(1) an estimate of net present value (or a valuation arrived at on an alternative basis, with an explanation of the basis and of the reasons for adopting it) of reserves	2.13; 10.2 to 10.9
	(2) the principal assumptions on which the valuation of proved and probable reserves is based including those relating to discount factors, commodity prices, exchange rates, realised prices, local fiscal terms and other key economic parameters	10.2
	(3) information to demonstrate the sensitivity to changes in the principal assumptions; or a statement that the valuation of reserves is omitted)	10.3.4; 10.4.4; 10.6
Appendix II (v)	Environmental, Social and Facilities – an assessment of	
	(1) environmental closure liabilities inclusive of biophysical and social aspects, including (if appropriate) specific assumptions regarding sale of equipment and/or recovery of commodities on closure, separately identified	9.2.1
	(2) environmental permits and their status including where areas of material non-compliance occur	4.4.2; 5.2.14; 5.3.14; 6.2.7;
	(3) commentary on facilities which are of material significance	None noted
Appendix II (vi)	Historic Production/Expenditures – an appropriate selection of historic production statistics and operating expenditures over a minimum of a three year period	5.2.7; 5.2.8; 5.2.9; 5.2.15; 5.3.7; 5.3.8; 5.3.15; 5.4.6; 5.4.7; 5.4.13
Appendix II (vii)	Infrastructure – a discussion of location and accessibility of the properties, availability of power, water, tailings storage facilities, human resources, occupational health and safety	2.7; 4.2
Appendix II (viii)	Maps etc. – maps, plans and diagrams showing material details featured in the text; and	Various

CESR Item	CESR Contents	Report Item
Appendix II (ix)	Special factors – if applicable a statement setting out any additional information required for a proper appraisal of any special factors affecting the exploration or extraction businesses of the company (for example in the polar regions where seasonality is a special factor).	6.2.1; 6.4.5; 9.0

End of Report



ANNEXURE 6

INDEPENDENT COMPETENT PERSONS' REPORTS

3. Illawarra Coal – Runge Pincock Minarco
-

This page has been intentionally left blank.

Competent Person Report

BHP Billiton and South32 Limited

Illawarra Coal Asset



ADV-SY-04120

10th March 2015



Document Control Sheet

Client	
BHP Billiton. Ltd., BHP Billiton Plc. and South32 Limited	
Report Name	Date
Competent Person Report – BHP Billiton Illawarra Coal Asset	10 th March 2015
Report No.	Revision No.
ADV-SY-04120	FINAL

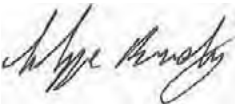
Authorizations				
Name		Position	Signature	Date
Prepared By:	David McMillan	Principal Underground Coal Mining Consultant		10/03/2015
Reviewed By:	Dan Peel	General Manager – Advisory		10/03/2015
Approved By:	Philippe Baudry	Executive General Manager - Advisory		10/03/2015

Organization	No. Of Hard Copies	No. Of Electronic Copies	Comment
BHP Billiton	0	1	

EXECUTIVE SUMMARY

RungePincockMinarco Limited
ABN 17 010 672 321
Level 12, 333 Ann Street
Brisbane QLD 4000

GPO Box 2774
Brisbane QLD 4001

BHP Billiton

Level 16, 171 Collins St
Melbourne, Victoria,
Australia, 3006

South32 Limited

10th March 2015

RE: Competent Person Report

Dear Sirs,

RungePincockMinarco Limited ("RPM") has been engaged by BHP Billiton Limited, BHP Billiton Plc. (collectively "BHP Billiton") and South32 (collectively the "Client") to undertake an Independent Technical Review ("ITR") and compile a Competent Person Report ("CPR" or the "Report") as defined by the European Securities and Markets Authority's Recommendations on consistent implementation of Commission Regulation ("EC") No 809/2004 implementing the Prospectus Directive (the "ESMA Recommendations").

The ITR has been completed in respect of the assets (the "Relevant Assets" or the "Project") of Illawarra Coal Holdings Pty. Ltd. ("Illawarra Coal") which are located in the Illawarra Region of New South Wales ("NSW"), Australia. Illawarra Coal is a wholly owned subsidiary of BHP Billiton and is expected to form part of South32, which is intended to be demerged from BHP Billiton.

The process and conclusions of the ITR are presented in the CPR which will be included in a United Kingdom prospectus prepared as part of the admission of South32's shares to listing on the Main Board of the London Stock Exchange as well as prospectuses for the Johannesburg Stock Exchange and Australian Securities Exchange.

With an average of 2,500 full time equivalent employees and contractors in FY2014, Illawarra Coal is forecast to produce approximately 12 Mt of ROM Coal and 9 Mt of Product Coal in FY 2015. The Product Coal is forecast to be a combination of export quality metallurgical (80%) and thermal coal (20%) during FY2015. Based on the current Coal Reserves; a 25 year life of mine is estimated with a product split of approximately 90% metallurgical and 10% thermal coal.

RPM's technical team ("the Team") consisted of Executive Mining and Infrastructure Engineers, Principal Environmental Consultant and Principal Coal Geologists. RPM's Competent Person was responsible for compiling or supervising the compilation of this Report and the Coal Reserves valuation contained herein. The estimates of Coal Resource and Coal Reserve (as defined in Appendix B) presented and reviewed in the ITR were prepared by Illawarra Coal's Competent Persons' and have not been independently estimated by RPM. The Team's qualifications and experience is detailed in **Annexure A**.

A site visit was conducted by the Team to the Project's mine sites and surface operations to familiarise themselves with the Projects. The site visit was undertaken from the 21st October to 23rd October, 2014 by Mr David McMillan, Mr Shaun Ayshford, Mr Peter Smith, Mr Ben Hall, Ms Lucy McMillan and Mrs Shoba Keys. During the site visits the Team inspected the mining operations, the coal preparation plants and conducted general inspections of the Project areas and had open discussions with BHP Billiton's personnel on technical aspects relating to the relevant issues. BHP Billiton's personnel were cooperative and open in facilitating RPM's work.

The CPR relies largely on information provided by Illawarra Coal, either directly from the sites and other offices, or from reports by other organisations whose work is the property of the Client or its subsidiaries. The CPR is based on information made available to RPM as at 8th December, 2014. The Client has not advised RPM of any material change, or event likely to cause material change, to the underlying data, designs or forecasts since the date of asset inspections.

Project Summary

- The Project consists of three operating underground longwall coal mines, one underground mine which is in care and maintenance, two coal preparation plants, supporting infrastructure and a head office. The Project is located in the Illawarra Region of NSW, Australia, approximately 75 km to 90 km south-west of Sydney and is readily accessible via road. The Project has road and rail haulage and direct access to port facilities. The Project is contained within numerous current mining tenements including mining leases, coal leases, consolidated coal leases, mining purposes leases, and exploration licences (authorisations).
- The Project includes the Appin Mine, West Cliff Mine and the West Cliff Coal Preparation Plant, collectively the Bulli Seam Operation (“BSO”) and the Dendrobium Mine, Cordeaux Mine (on long term care and maintenance) and the Dendrobium Coal Preparation Plant, collectively the Dendrobium Operation.
- The Projects are located within the Southern Coalfield in the southern portion of the Sydney Basin. There is extensive mining and exploration history within the region, with the first commercial mining of coal commencing around 1848. Consequently the geology of the Southern Coalfield is well understood. The Illawarra Coal Measure contains a number of coal seams, however the two key economic seams developed in the Project area are the Bulli and Wongawilli Seams. The Cordeaux Mine previously worked in the Bulli Seam and although the Wongawilli Seam extraction may be considered from Cordeaux in the future, it is not currently scheduled within the Life of Asset Plan.
- The coal seams are extracted via conventional retreat longwall methods with a single longwall currently operating in each mine. This mining method has been in operation at the Project since commencement of underground mining, as such is well understood as are the geological and mine operating conditions. The mines are supported by an extensive local and regional infrastructure network which connects the mines to the two preparations plants (West Cliffs 7.5 Mtpa ROM and Dendrobium 5.0 Mtpa) via road or rail and subsequently to domestic and international markets through the deep water Port Kembla Coal Terminal.
- The Product Coal is forecast to be a combination of export quality metallurgical (80%) and thermal coal (20%) during FY2015 however based on the current Coal Reserves a 25 year life of mine is estimated with a product split of approximately 90% metallurgical and 10% thermal coal. Coal is exported via the Port Kembla Coal Terminal of which Illawarra Coal has a 1/6th ownership of its operator, Port Kembla Coal Terminal Ltd.

Coal Resource and Coal Reserves Review

- This Report contains information on the Coal Resources (inclusive of Coal Reserves) as reported by: H Kaag (MAusIMM) - Appin, West Cliff, Dendrobium and Cordeaux, and Coal Reserves as reported by: M Rose (MAusIMM) - Appin, West Cliff and Dendrobium. The information is extracted from the report titled BHP Billiton 2014 Annual Report and is available to view on www.bhpbilliton.com.
- RPM completed a review of the Coal Resource and Coal Reserve completed by Illawarra Coal as at 30th June 2014. RPM considers that the Coal Resources and Coal Reserves are reasonable and did not identify any material errors or omissions.
- RPM reviewed the extensive geological dataset that has been applied to the Coal Resource estimate by Illawarra Coal. The geological dataset has been developed over a long period of time and it is noted that, over the years, there have been different exploration activities and techniques applied. Historical geological data has been converted from imperial to metric units and from Integrated Survey Grid (ISG) to the Map Grid of Australia (MGA). However, since 2006 Illawarra Coal has applied consistent

standards and procedures to their exploration activities and data management. The geological dataset is considered to be well managed and correctly applied to the estimation of Coal Resources.

- Illawarra Coal has completed extensive activities relating to the identification and understanding of geological structures at the Project. This is of particular importance due to the application of the longwall mining method, the depth of the operations, the geotechnical issues previously encountered and the identification of both faulting and igneous activity at the Project. As a result, Illawarra Coal has good understanding of the geological structures at the Project.
- Coal Resources were reported as a combination of Measured, Indicated and Inferred Resource categories as per the definitions from the JORC Code. The Resource Categorisation areas were based on distances from Points of Observations as well as a reliability ranking of the geological data, the presence of seismic data and Surface to Seam drilling. Resource constraints were also applied to areas of previous mining, areas beneath environmentally sensitive areas and surface constraints associated with Lake Cordeaux, Lake Avon and the exclusion zones around the Lake Cordeaux Dam Wall. Illawarra Coal also downgraded resources if the area had been adversely impacted by intrusions or faulting.
- Coal Reserves were reported as a combination of Proved and Probable Reserves. Modifying factors including mining approval status, geological structure and gas environment were used in the consideration of Reserve categorisation. Proved and Probable Coal Reserves were estimated from the Measured and Indicated Resources only.
- RPM note that the calorific value of the Marketable Coal Reserves for the thermal coal product from Dendrobium have not been public reported. Based on information provided to RPM, this has been estimated at 26.60 MJ/kg, product coal at 7% moisture levels.
- The breakdown by classification (100% basis) of the Coal Resources and Coal Reserves is contained in Tables A and Table B respectively. All tonnes and quality information has been rounded, hence small differences may be present in the totals.

Mining Operations

- All mining operations conducted at the Project utilise the underground longwall method. With a long operating history the assets are well understood and operating practices are mature and of a high standard. Coal mined at the longwall face is transported via belt conveyor systems through the mine workings to the mine entry. For the Appin and Dendrobium mines the conveyor is extended along an inclined roadway directly to the surface whereas at West Cliff a vertical shaft is used to transport coal out of the mine; in a future upgrade coal exiting the mine through West Cliff will also travel on a conveyor belt along an inclined drift to the surface.
- Once at the surface the coal is transported to the preparation plants via a number of methods. Within the BSO at West Cliff the coal is conveyed directly to the coal preparation plant, however at Appin it must be transported via truck to the West Cliff coal preparation plant. At Dendrobium a rail line is used to transport the ROM coal from the mine to the processing plant that is located 8 km away at Port Kembla.
- Key features of the Bulli Seam Operation include:
 - The BSO incorporates the current and future expanded operations of both the Appin and West Cliff Mines. The depth of cover over the planned BSO operations ranges from a minimum of approximately 450 m in the West Cliff and Appin Area 7 to a maximum of about 850 m in Appin Area 9. This makes the BSO workings some of the deepest in Australia which is of significance to both the productivity of the development and longwall systems as well as the cost of extraction.
 - The Bulli Seam ranges in thickness from approximately 1.8 m in the current West Cliff area to 3.6 m in Appin Area 7. The longwall working section generally follows the full-seam thickness although extraction is constrained to the specific equipment operating range.

Table A - Coal Resources as at 30 June 2014 in 100% Terms (as Reported by Illawarra Coal)*

Commodity Deposit	Mining Method	Coal Type	Measured Resources				Indicated Resources				Inferred Resources				Total Resources				BHP Billiton Interest
			Mt	% Ash	% VM	% S	Mt	% Ash	% VM	% S	Mt	% Ash	% VM	% S	Mt	% Ash	% VM	% S	%
Appin	UG	Met/Th	157	11.2	23.8	0.37	256	12.6	24.2	0.36	289	13.5	23.8	0.36	702	12.7	24.0	0.36	100
West Cliff	UG	Met/Th	21	12.3	21.3	0.36	21	11.9	20.7	0.34	68	13.9	19.9	0.33	110	13.3	20.3	0.34	100
Dendrobium	UG	Met/Th	86	29.8	23.7	0.59	91	29.8	23.1	0.58	118	29.4	22.8	0.58	295	29.6	23.2	0.58	100
Cordeaux	UG	Met/Th	5.2	28.7	21.1	0.58	109	29.1	21.5	0.56	85	29.0	22.1	0.57	199	29.0	21.8	0.57	100

Note:

- The coal quality for Illawarra Coal is for insitu quality on an air-dried basis. Tonnages are on an insitu moisture basis. VM is volatile matter, and S is sulphur.
- No seam thickness cut-off because the minimum thickness is economic.

Source: BHP Billiton 2014 Annual Report

Table B - Coal Reserves as at 30 June 2014 in 100% Terms (as Reported by Illawarra Coal)*

Commodity Deposit	Mining Method	Coal Type	Proved Coal Reserve	Probable Coal Reserve	Total Coal Reserve	Proved Marketable Coal Reserve				Probable Marketable Coal Reserve				Total Marketable Coal Reserve				Reserve Life	BHP Billiton Interest
			Mt	Mt	Mt	Mt	% Ash	% VM	% S	Mt	% Ash	% VM	% S	Mt	% Ash	% VM	% S	Years	
Appin	UG	Met/Th	24	133	157	20	8.9	23.5	0.37	112	8.9	24.9	0.36	132	8.9	24.7	0.36	25	100%
West Cliff	UG	Met/Th	5.4	0.4	5.8	3.8	8.9	20.6	0.36	0.3	8.9	20.1	0.36	4.1	8.9	20.6	0.36	2	100%
Dendrobium	UG	Met	21	24	45	8.6	9.7	23.8	0.59	9.9	9.7	24.2	0.59	18	9.7	24.0	0.59	8.9	100%
		Th				5.2	23.0			6.3	23.0			12	23.0				

Notes:

- Only geo-physically logged, fully analysed cored holes with greater than 95% recovery were used to classify the reserves. Drill hole spacings vary between seams and geological domains and were determined in conjunction with geo-statistical analyses where applicable. The range of maximum spacings was: Appin: Proved - 700 m, Probable - 1,500 m, West Cliff: Proved -700 m, Probable - 1,500 m, Dendrobium: Proved -700 m, Probable - 1,500m

- Product Recovery for the operations were Appin - 84%, West Cliff - 71%, Dendrobium - 67%

- Total Coal Reserves are at the moisture content when mined of; Appin and West Cliff - 6%, Dendrobium -7%. Total Marketable Coal Reserves are the tonnes of coal available, at a moisture content of; Appin and West Cliff – 9%; Dendrobium Met – 13.5% and Dendrobium Th – 7%, and air-dried qualities, for sale after the beneficiation of the Total Coal Reserves.

- Cut-off criteria applied: Appin, West Cliff, Dendrobium ≥ 1.8m seam thickness.

- Coal delivered to wash plant.

Source: BHP Billiton 2014 Annual Report

- Seam gas presents both a significant production and safety risk to BSO. Both surface to in seam (“STIS”) and underground in seam (“UIS”) gas drainage methods are employed in advance of mining, and the operation also employs a series of ventilation related gas management strategies to assist in mitigation of this risk. BSO has more than 40 years’ experience in operating in a high gas environment; as such mitigation practices are well established.
- Igneous dykes have intruded into portions of Appin Area 7 and Area 9. The strength of these features can exceed the cutting capability of the longwall and require drilling and blasting to allow the longwall to pass. BSO have adopted the approach of pre-mining the dykes and filling the void with low-strength concrete to allow the longwall to negotiate the area without incurring significant delay.
- The West Cliff Mine is currently mining in its penultimate longwall panel, and production from West Cliff’s final panel is planned to be completed by the end of April 2016. Upon completion of the West Cliff workings, operations will be relocated to the first panel in Appin Area 9.
- The planned closure of West Cliff Mine at the end of FY2016 and the commencement of coal production at Appin Area 9 is a fundamental change for the BSO. This change will result in the BSO transitioning from two smaller mining operations, to a single, larger and more complex mine operating two longwalls.
- Key features of the Dendrobium Operation include:
 - Dendrobium Mine commenced operations in the Wongawilli Seam in 2002. Historical mine performance has steadily increased, from around 3.0 Mtpa ROM to 4.5 Mtpa ROM. The operation has previously been hampered by a fragmented mine layout, necessary to extract small blocks of resource between igneous intrusions. The current mining area is larger and offers the opportunity for the mine to operate more efficiently, extracting longwall panels sequentially over an extended period without relocation.
 - The mine operates in an area that has been subjected to a considerable amount of igneous activity. Although igneous intrusions are typically problematic to longwall operations, the mine layout at Dendrobium has been designed to avoid the major sills and dykes. The remaining dykes that intersect planned longwall panels are not expected to represent a significant impediment to operational performance.
 - In recent years the mine has experienced roof failures, two in the main access road and two in the longwall gateroad. These incidents significantly impacted the productivity of the operation whilst remediation work was carried out. Measures have been put into place to reduce the risk of a recurrence of such events.
- ROM Coal Production for the Project is summarised in Figure A. The quantities are based on the Project’s Coal Reserve.

Figure A - Life of Project ROM Coal Production

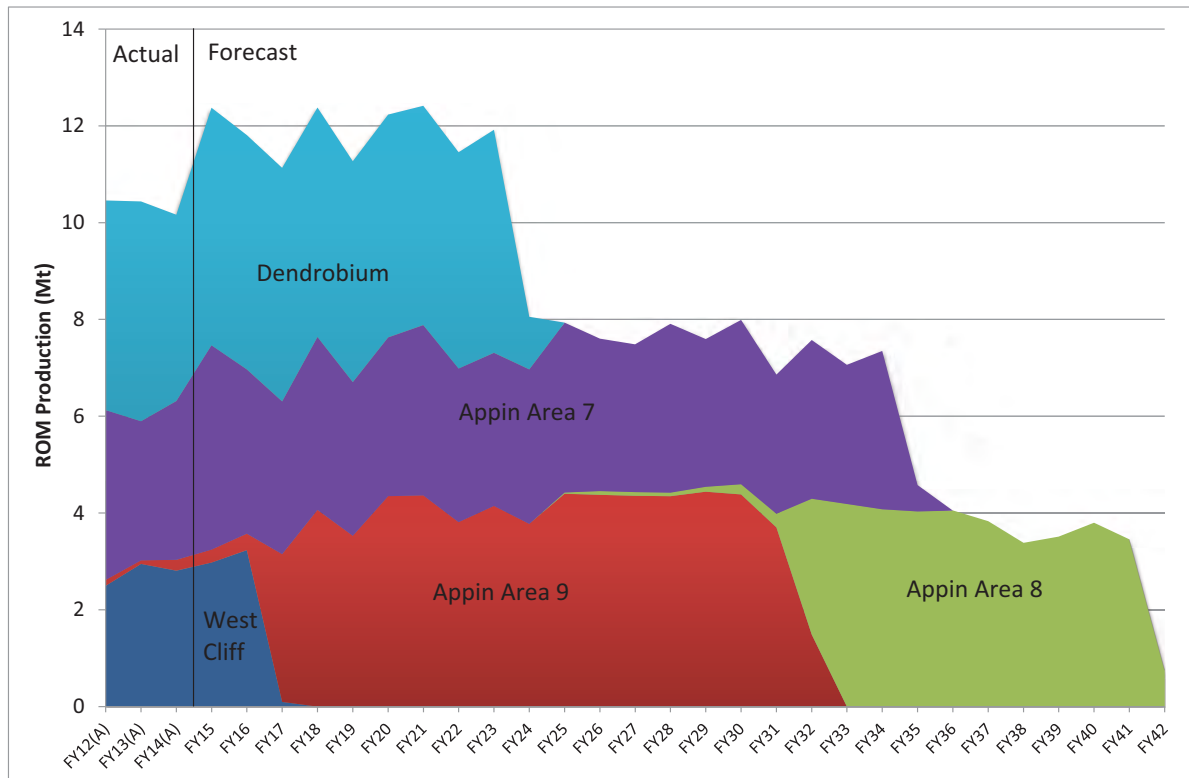

Coal Preparation and Logistics

- The Project’s coal processing and logistics arrangement are considered to be sufficient to support the Project’s life of asset plan.
- All coal is processed at the West Cliff or the Dendrobium Coal Preparation Plants. The West Cliff plant is located adjacent to the West Cliff Mine and predominately receives coal from the BSO. The Dendrobium plant is located at the third party BlueScope Steelworks adjacent to Port Kembla Coal Terminal and predominately receives coal from the Dendrobium Mine.
- The operation of the West Cliff Coal Preparation Plant is heavily reliant on road transportation for both raw and product coal with approximately half the ROM feed delivered by road from the Appin Shaft. During the FY2014 the plant processed 5.9 Mt. The current installed capacity is considered to be adequate to meet the average throughput of 7.4 Mtpa required in the life of asset plan. Peaks in production above this level (up to 7.8 Mtpa on occasions) could be accommodated through scheduling adjustments. The haulage of product material to Port Kembla is approximately 40 km by road descending the steep escarpment and via the Wollongong bypass.
- The Dendrobium Coal Preparation Plant is an older facility that was originally built as a part of the integrated steelworks to treat coal from a number of different mines. A lease of this facility was arranged when BlueScope demerged from BHP Billiton. The plant is contained within the boundary of the steelworks on a relatively small and narrow footprint.
- ROM coal is transported from the Dendrobium Mine to the Coal Preparation Plant via rail. As there is no facility for on-site disposal of the discard material from the Dendrobium Coal Preparation Plant this material is transported to the West Cliff Preparation Plant disposal facility. This is facilitated by the back loading of trucks delivering product coal to Port Kembla from the West Cliff Coal Processing Plant. Product coal is trucked a short distance to Port Kembla.

- The installed plant capacity of the Dendrobium Coal Processing Plant is expected to be able to meet the maximum forecast throughput of 5.1 Mtpa. During FY2014 due to the limited coal feed, the plant processed 4.0 Mt.
- Export coal is transported through the Port Kembla Coal Terminal (PKCT). PKCT is privately managed by Port Kembla Coal Terminal Limited under lease to Port Kembla Port Corporation. All Illawarra Coal is trucked to the terminal.

Environmental

- Illawarra Coal's key mining operations, at the BSO and Dendrobium Operation, hold separate development consents and current mining titles. Numerous subsidiary licences, approvals and permits are in place for the operations covering longwall extraction, water licenses and mining-related infrastructure.
- Environmental and social management of the mining operations involve comprehensive technical assessment and monitoring of natural landscape features such as swamps, cliffs and streams especially in relatively pristine areas of the Sydney drinking water catchment. In other areas, the management of the potential effects of mining on surface features relates to rural residences and related structures as well as major linear infrastructure such as pipelines, transmission lines, railway and major roads and their related structures such as embankments and bridges. Illawarra Coal demonstrates industry leading practice in monitoring and mitigation of mining impacts on major infrastructure.
- The Project implements a certified environmental management system and conduct ongoing and productive community engagement and government interaction.
- The area of future mining exhibits surface environmental management constraints that are similar to those that have been successfully addressed to date. The current management systems and approaches are appropriate and no planning and management risks are expected.

Operating, Capital Costs and Valuation of Reserves

- Total capital expenditure throughout the life of the asset is forecast at approximately AUD 2,997 M consisting of AUD 2,368 M in sustaining capital, AUD 407 M for major projects, and AUD 222 M in growth capital. The sustaining capital estimate includes major equipment replacements and regular upgrades to fixed plant forecast to FY 2042.
- Illawarra Coal is undergoing a period of significant operational change which is reflected in an increase in capital spend on major projects. The major projects forecast for the next four year period include:
 - Appin Area 9 Project – AUD 115 M. The Area 9 Project has already commenced. This expenditure allows for the ongoing development of mains, a ventilation shaft and the establishment of the first two longwall panels.
 - Additional Longwall Supports – AUD 94 M. Redevelopment of the old Dendrobium longwall powered roof supports for relocation to BSO.
 - Mount Batten Gas Plant – AUD 36 M. Expansion of the gas drainage infrastructure for Appin operations.
 - PKCT Restoration and Compliance – estimated AUD 132 M. Illawarra Coal's contribution for the restoration and compliance works is estimated to be AUD 132 M; however the final contribution required is subject to Illawarra Coal's proportion of terminal usage over the period of the program of works.
- Forecast Total Project Operating Costs (excluding tax, royalties and Amortisation and Depreciation) average AUD 102.10/t sales over the life of asset. These costs include a life of asset mining operating cost of AUD 66.80/t sales, raw coal logistics cost of AUD 2.00/t sales, processing cost of AUD 7.30/t

sales, refuse emplacement cost of AUD 0.40/t sales, clean coal logistics cost of AUD 7.20/t sales, port costs of 3.60/t sales, closure costs of 1.10/t sales, marketing cost of 1.90/t sales and General and Administration of AUD 11.80/t sales. A detailed breakdown is supplied in **Section 11**.

- Total costs typically range from AUD 90/t sales to AUD 100/t sales for the life of the asset. Costs increase during FY2025 to FY2035 due to the loss of the low cost Dendrobium Mine contribution to the blend and deeper, more challenging conditions at the BSO. From FY2035 costs significantly increase as Area 7 ceases operation and economies of scale are reduced. Costs are forecast to be above AUD 120/t sales over the period FY2035 to FY2042.
- RPM used a Net Present Value (NPV) approach to estimate the value of Coal Reserves at Illawarra Coal. A deterministic approach was taken with estimations of the valuation inputs, based on historical performance, future planned activity and RPM's professional view of expected outcomes. A summary of the Reserve Valuation results is provided in the Table C.

Table C- Coal Reserve Valuation Model Outcomes

	Units	Illawarra Coal
Years of Production	Years	27
Peak Production/Sales	Mtpa	10
Total Product Tonnes in Model	Mt	164
Coal Quantities*	Mt	211
Average Coal Revenue	AUD/ sales t	138.9
Average Operating Costs	AUD/ sales t	102.1
Average Margin	AUD / sales t	36.8
Total Capital Expenditure	M AUD	2,997
Total Valuation @ 10% Disc Rate	M USD	1,517

* Coal Reserve based on Illawarra Coal's 30th June 2014 Coal Reserve estimate. The quantities applied to the Reserve Valuation model have been adjusted based on RPM's Coal Reserve review and depleted to reflect forecast production to 31st December 2014.

- The Reserve Valuation was based on the estimated mining coal quantities remaining at the Project as at 31st December 2014.
- Major inputs to RPM's Reserve Valuation included RPM's review of Illawarra Coal's life of asset plan and associated costs and other documentary evidence provided by Illawarra Coal. Forecast coal prices and exchange rates are based on a consensus view (mean view) of numerous internationally recognised forecasting organisations. The forecasts were current as at October 2014. Further details of the Reserve Valuation are provided in **Section 12** of the CPR.

The key opportunities identified for the Project during the review are outlined below:

RPM considers that there are several opportunities within the Project. These include:

- **Coal Reserve Expansion:** There are opportunities to potentially expand the area of Coal Reserves. Each opportunity requires additional exploration, feasibility studies and receipt of additional licences and approvals before the opportunity has the potential to be realised.
 - Illawarra Coal holds exploration title over Appin Area 10 but do not have operating approvals or Development Consent. Appin Area 10 is located northwest of Areas 7 and 9.
 - The Wongawilli Seam in the vicinity of the Cordeaux Mine. Additional feasibility studies are required to determine the potential economics of this area.
- **Project Cost Saving Initiatives:** Illawarra Coal has been implementing a broad Project cost reduction initiative over the past 6 months. A range of cost savings have been identified and programmes are being implemented to achieve these. On average, Illawarra Coal has identified AUD 85 M of cost savings per year over the remaining life of asset, of which RPM has recognised on average AUD 50 M of savings per year in the valuation.

- **Rationalise Group Engineering Functions:** Current engineering standards are very high with some apparent levels of redundancy within the engineering input and support to the operations. An opportunity exists to review the group engineering functions to reduce the cost base.
- **Sell Redundant Assets:** Identify non-core assets, functions and services and determine their optimum value to the ongoing business.
- **Execute the Appin Coal Clearance Project:** Implement the replacement of the ageing coal clearance infrastructure at the pit bottom and coal clearance drift area of Appin Mine as well de-bottleneck other parts of the BSO coal clearance system. This will result in higher production utilisation and lower operating costs. This initiative is not included in the current life of asset plan.

The key risks identified to the Project during the review are outlined below:

- **Seam Gas and Strata Emissions.** Significant production and safety risk is present at BSO from seam and strata gas emissions. The current mining activities in West Cliff, Appin Area 7 and the newly developed Area 9 are all affected by these types of gas emissions. Unless these are controlled by a life of mine gas management strategy there is a very high likelihood these emissions will have a significant impact on annual production levels. A review should assess the effectiveness of mine ventilation as well as gas pre-drainage and post-drainage methods so as to enable continuous high production.

Illawarra Coal has 40 years' experience operating in a high gas environment. The technical knowledge and understanding of the gas reservoir in, above and below the Bulli Seam means management is well equipped to mitigate the impact on future production. Controls used to eliminate or at least mitigate these occurrences include continued pro-active seam gas reservoir testing and modelling so the appropriate planned gas drainage metres are drilled in a timely manner.

- **Geotechnical Issues.** There is a risk that the inability to manage and overcome regular geotechnical problems relating to rib and roof stability in development and longwall mining could result in each mine not meeting their annual production budget. Illawarra Coal has been pro-actively managing these issues over many years. This risk is a greater concern at Dendrobium Mine due to the nature and thickness of the Wongawilli Seam.
- **Major Service Supplier Risk.** Services to the Dendrobium Preparation Plant are provided by the BlueScope Steelworks. Loss of services from BlueScope Steel provided to Dendrobium Coal Preparation Plant and coal delivery to Port Kembla could affect production from Dendrobium.
- **Risks Inherent to Longwall Operations.** There are operating risks common to almost all underground longwall coal operations. These include:
 - Explosion: the risk of seam gases underground being within an explosive range and being ignited by spontaneous combustion or other ignition source.
 - Fire: out of control fire affecting a significant portion of the underground workings.
 - Flooding or inrush from surface water bodies, aquifers or old working areas.
 - Major roof collapse in the maingate, tailgate or across the longwall face resulting in an extended interruption to longwall operations.
 - Excessive weight on the longwall and/or soft floor resulting in the longwall mining into the floor horizon.

Illawarra Coal has established operating procedures to address these risks which are inherent to underground longwall coal mining and have been managing these issues pro-actively and usually successfully over many years as and when they have arisen.

- **Project Cost Savings Initiatives.** Illawarra Coal has implemented a range of Project cost saving initiatives over the past six months. RPM has included an average of AUD 50 M savings per year in the

valuation model based on this initiative. Illawarra Coal may not achieve the full forecast cost savings over the Project life.

- **Damage to Surface Environment.** Environmental and social management of the mining operations involve comprehensive technical assessment and monitoring of natural landscape features such as swamps, cliffs and streams especially in areas of the Sydney drinking water catchment. In other areas, the management of the potential effects of mining on surface features relates to rural residences and related structures as well as major linear infrastructure such as pipelines, transmission lines, railway and major roads including embankments and bridges. Illawarra Coal demonstrates industry leading practice in monitoring and mitigation of mining impacts on major infrastructure.

Despite this, there is a risk that unforeseen damage to surface environments (hydrogeological and/or high value ecological communities, or critical infrastructure) beyond that envisaged in existing technical assessments and approval conditions may impact Illawarra Coal's ability to implement their operations as currently forecast.

- **Carbon Emissions Cost.** The Australian Government revoked the carbon tax from 1 July 2014. Within the life of asset it is possible that a cost on carbon could potentially be imposed for carbon dioxide equivalent (CO₂e) emissions from Illawarra Coal mining operations (either by way of a tax, levy or the cost of tradeable emission certificates). The detail of any such potential costs cannot be foreseen and could be dependent on both domestic and international factors. It is notable that such a cost imposition would be part of a broad-based policy regime that would also affect other Australian coal operations in a manner commensurate with their emissions profile.

Refer to **Section 13** for further details on risks and opportunities.

RPM Qualifications and Experience

RPM's advisory division operates as independent technical consultants providing services across the entire mining life cycle including exploration and project feasibility, resource and reserve evaluation, mining engineering and mine valuation services to both the mining and financial services industries.

RPM is the market leader in the innovation of advisory and technology solutions that optimise the economic value of mining assets and operations. RPM has serviced the industry with a full suite of advisory services for over 45 years and is the largest publicly traded independent group of mining technical experts in the world having completed over 12,000 studies across all major commodities and mining methods, and worked in over 118 countries globally. This report was prepared on behalf of RPM by technical specialists, details of whose qualifications and experience are set out in **Appendix A**.

RPM has been paid, and has agreed to be paid, professional fees based on a fixed fee estimate for its preparation of this Report. RPM's remuneration is not dependent upon the findings of this report nor on the outcome of the proposed listing.

The authors of this CPR do not have any economic or beneficial interest (present or contingent) in:

- The Project, securities of the companies associated with the Project or that of the Client; or
- Any right or options in the Project; or
- The outcome of the proposed listing.

RPM does not warrant the completeness or accuracy of information provided by the Client which has been used in the preparation of this report.

The title of this report does not pass to the Client until all consideration has been paid in full.

Drafts of this report were provided to the Client, but only for the purpose of confirming the accuracy of factual material and the reasonableness of assumptions relied upon in the report.

Generally, the data available was sufficient for RPM to complete the scope of work. The quality and quantity of data available, and the cooperative assistance, in RPM's view, clearly demonstrated the Client's commitment to the ITR process. All opinions, findings and conclusions expressed in the report are those of RPM and its specialist advisors.

Yours faithfully,



David McMillan

Principal Underground Coal Mining Consultant

Table of Contents

EXECUTIVE SUMMARY	ii
Table of Contents	xiii
List of Tables	xv
List of Figures	xv
List of Annexures	xvi
1 Introduction	1
1.1 Scope of Work	1
1.2 Relevant Assets	2
1.3 Review Methodology	2
1.4 Site Visits and Inspections	3
1.5 Information Sources	3
1.6 Illawarra Coal FY2014 Coal Resources and Coal Reserves	3
1.7 Study Team	4
1.8 Limitations and Exclusions	6
2 Project Overview	8
2.1 Project Location and Access	8
2.2 Project Description	8
2.3 Regional Environment	11
2.4 Regional and Local Infrastructure	12
3 Licences and Permits	15
3.1 Mining Tenements	15
3.2 Exploration Titles	15
4 Geology	18
4.1 Regional Geology	18
4.2 Exploration	26
4.3 Geological Data	27
4.4 Geotechnical and Hydrogeological Conditions	30
5 Geological Models and JORC Coal Resource Review	33
5.1 Geological Models	33
5.2 JORC Coal Resource Review	37
6 JORC Coal Reserves Review	47
6.1 Estimate Methodology	47
6.2 Bulli Seam Operation Estimate Review	47
6.3 Dendrobium Operation Estimate Review	49
6.4 Coal Reserves	51
6.5 Coal Reserve Status	53
7 Mining	54

7.1	Mining Overview	54
7.2	Bulli Seam Operations	55
7.3	Dendrobium Mine	62
8	Equipment and Infrastructure.....	70
8.1	Bulli Seam Operation.....	70
8.2	Dendrobium Mine	75
9	Processing and Logistics	79
9.1	Processing.....	80
9.2	Logistics.....	82
9.3	Products	84
9.4	Port Kembla Coal Terminal.....	86
10	Environmental, Social & Facilities	88
10.1	Bulli Seam Operation.....	88
10.2	Dendrobium	92
11	Operating & Capital Costs	95
11.1	Operating Costs.....	95
11.2	Capital Expenditure	100
12	Valuation of Reserves	104
12.1	Valuation Methodology	105
12.2	Valuation Modelling Parameters.....	105
13	Risks & Opportunities	110
13.1	Opportunity	110
13.2	Risk.....	111

List of Tables

Table 3-1 - Illawarra Coal Mining Leases	15
Table 3-2 - Illawarra Coal Exploration Leases	16
Table 5-1 - Modelled Coal Qualities	36
Table 5-2 - Coal Resources as at 30 June 2014 in 100% Terms (as Reported by Illawarra Coal)	43
Table 5-3 - Quantity of Depleted Coal Resource (30 th June 2014 to 31 st December 2014)	44
Table 6-1 - Coal Reserves as at 30 June 2014 in 100% Terms (as Reported by Illawarra Coal)	52
Table 7-1 - Total Mine Production	55
Table 8-1 - Roof Support Moves	71
Table 8-2 - Roof Support Moves	76
Table 9-1 - Plant Production	79
Table 9-2 - Life of Asset Yield Profile*	79
Table 9-3 - Bulli Coking Coal Typical Analysis	85
Table 9-4 - Wongawilli Coking Coal Typical Analysis	85
Table 9-5 - Illawarra Blend Coking Coal Typical Analysis	86
Table 9-6 - Illawarra 5600 Energy Product Typical Analysis	86
Table 10-1 - Estimated Mine Closure Costs (AUD M)	88
Table 11-1 - Life of Mine Mining Cost Breakdown (AUD/t ROM)	96
Table 11-2 - Total Operating Costs (AUD/t sales)	99
Table 11-3 - Five-Year Plan for Major Capital Projects	101
Table 11-4 - Sustaining Capital Allowances FY2020 - FY2042	102
Table 12-1 - Run of Mine Production Profile	106
Table 12-2 - Product Profile	106
Table 12-3 - Consensus Coal Price Forecasts (USD/t)	107
Table 12-4 - Life of Asset Coal Sales	107
Table 12-5 - Realised Coal Prices Estimate	107
Table 13-1 - Risk Assessment Ranking	111
Table 13-2 - Business and Mine Risk Assessment	112

List of Figures

Figure 2-1 - Relevant Assets Location	10
Figure 2-2 - Site Location Plan - BSO	13
Figure 2-3 - Site Location Plan - Dendrobium	14
Figure 4-1 - General Stratigraphy of the Southern Coalfields	20
Figure 4-2 - General Stratigraphy of the Illawarra Coal Measures	21
Figure 4-3 - Seam Subdivision of the Wongawilli Seam for the Dendrobium Operation	22
Figure 4-4 - Known and Interpreted Structural Features - BSO	24
Figure 4-5 - Known and Interpreted Structural Features- Dendrobium	25
Figure 5-1 - Structural Cross Section - BSO	34
Figure 5-2 - Structural Cross Section - Dendrobium	35
Figure 5-3 - Raw Ash and Coking Product Yield - BSO	38

Figure 5-4 - Raw Ash and Coking Product Yield - Dendrobium	39
Figure 5-5 - Resource Categorisation Areas - Bulli Seam	45
Figure 5-6 -Resource Categorisation Area for the Wongawilli Main Working Section	46
Figure 7-1 - Illawarra Coal Optimised Base Plan ROM Output	54
Figure 7-2 - Mine Layout - BSO	57
Figure 7-3 - Bulli Seam Contours - Gas Content (m ³ /t).....	59
Figure 7-4 - Bulli Seam Contours - Composition (methane ratio).....	59
Figure 7-5 - Scheduled Gas Drainage Drilling - BSO	60
Figure 7-6 - Mine Layout - Dendrobium	63
Figure 7-7 - Dendrobium Mine Geological Features.....	65
Figure 7-8 - Eloura Fault Disturbed Ground Boundaries	66
Figure 7-9 - Wongawilli Gas Content and Composition	68
Figure 9-1 - West Cliff Coal Processing Flow Sheet.....	81
Figure 9-2 - Dendrobium Coal Handling and Processing Plant Flow Sheet.....	82
Figure 9-3 - Surface Transport Logistics.....	83
Figure 10-1 - Extent of Bulli Seam Operation Mining Leases	90
Figure 10-2 - Extent of Dendrobium Mining Lease	94
Figure 11-1 - Mining Cost Profile	97
Figure 11-2 - Total Cost (AUD/t produced)	100
Figure 11-3 - Illawarra Coal Capital Expenditure Plan.....	101
Figure 12-1 - Valuation Sensitivity Assessment (USD M).....	104

List of Annexures

- Annexure A - Qualifications and Experience
- Annexure B - Glossary of Terms
- Annexure C - Additional Licences and Approvals

1 Introduction

RungePincockMinarco Limited (“RPM”) has been engaged by BHP Billiton Limited, BHP Billiton Plc. (collectively “BHP Billiton”) and South32 Limited (“South32” and collectively the “Client”) to undertake an Independent Technical Review (“ITR”) and compile a Competent Persons Report (“CPR” or the “Report”) as defined by the European Securities and Markets Authority’s Recommendations on consistent implementation of Commission Regulation (EC) No 809/2004 implementing the Prospectus Directive (the “ESMA Recommendations”). The ITR has been completed in respect of the assets (the “Relevant Assets” or the “Project”) of Illawarra Coal Holdings Pty. Ltd. (“Illawarra Coal”). Illawarra Coal is a wholly owned subsidiary of BHP Billiton and is expected to form part of South32, which is intended to be demerged from BHP Billiton.

The process and conclusions of the ITR are presented in the CPR which will be included in a United Kingdom prospectus prepared as part of the admission of South32’s shares to listing on the Main Board of the London Stock Exchange as well as prospectuses for the Johannesburg Stock Exchange and Australian Securities Exchange.

The Project consists of three operating underground longwall coal mines, one underground mine in care and maintenance, two coal preparation plants, supporting infrastructure and a head office. The Project is entirely located within the Illawarra Region approximately 75 to 90 km south of Sydney, Australia.

With an average of 2,500 full time equivalent employees and contractors in FY2014, the Project is forecast to produce approximately 12 Mt of ROM Coal and 9 Mt of Product Coal in FY 2015. The Product Coal is forecast to be a combination of export quality metallurgical (80%) and thermal coal (20%) during FY2015. Based on the current Coal Reserves, a 25 year life of mine is estimated with a product split of approximately 90% metallurgical and 10% thermal coal.

1.1 Scope of Work

RPM’s scope of work included the compilation of a CPR as defined by the ESMA Recommendations. The CPR includes:

- Legal and geological overview including the nature and extent of the rights of exploration and extraction and a description of the properties to which the rights attach and any necessary licences and consents including planning permission. Any other material terms and conditions of exploration and extraction;
- A description of the geological characteristics of the properties, the type of deposit, its physical characteristics, style of mineralisation, including a discussion of any material geotechnical, hydro-geological, hydrological and geotechnical engineering issues;
- A table providing data on Inferred, Indicated and Measured Resources, and Proved and Probable Reserves and a statement regarding the internationally recognised reporting standard;
- A description of the methodology used by the Competent Person in reviewing the resource and reserve estimates supplied by Illawarra Coal and a description of the evidence, supporting information and analyses used to substantiate the estimates;
- A description of any independent audits that have been conducted on Coal Resource or Coal Reserve estimates;
- A statement as to whether Coal Resources are reported inclusive or exclusive of Coal Reserves;
- For Proved and Probable Reserves a discussion including supporting assumptions for the applied:
 - mining method, metallurgical processes and production forecast;
 - markets for the company’s production and commodity price forecasts;

- mine life;
- other modifying factors; and
- capital and operating cost estimates.
- Environmental, social and facilities including an assessment of:
 - environmental closure liabilities inclusive of biophysical and social aspects, including plan and forecast cost of activities (if appropriate), ongoing monitoring requirements, bonds (if applicable), cost provisions and specific assumptions regarding sale of equipment and/or recovery of commodities on closure, separately identified;
 - environmental permits and their status including where areas of material non-compliance occur; and
 - commentary on facilities which are of material significance.
- Historic production and expenditure;
- Infrastructure including a discussion of location and accessibility of the property, availability of power, water, tailings storage facilities, human resources, and occupational health and safety;
- Special factors including, if applicable, a statement setting out any additional information required for a proper appraisal of any special factors affecting the exploration or extraction businesses of the company;
- Taking consideration of internationally recognised valuation codes a valuation of reserves comprising:
 - An estimate of net present value of Coal Reserves;
 - The principal assumptions on which the valuation of Proved and Probable Reserves is based including those relating to discount factors, commodity prices, exchange rates, realised prices, local fiscal terms and other key economic parameters; and
 - Information to demonstrate the sensitivity to changes in the principal assumptions.

1.2 Relevant Assets

The Relevant Assets include the Bulli Seam Operation (the “BSO”) and the Dendrobium Operation which are located approximately 75 to 90 km south of Sydney, Australia. The BSO consists of the Appin and the West Cliff Coal Mines and the West Cliff Coal Preparation Plant and the Dendrobium Operation consists of the Dendrobium Mine, the Cordeaux Coal Mine (on care and maintenance since 2001) and the Dendrobium Coal Preparation Plant. Both operations have supporting infrastructure owned and operated by Illawarra Coal.

1.3 Review Methodology

RPM’s ITR methodology was:

- Review existing reports and data;
- Conduct a Competent Person’s site visit;
- Discussions with Project personnel prior to and following the site visit;

- Review of the Coal Resources and Coal Reserves in accordance with the guidelines of the 2012 Edition of The Australasian Code for Reporting of Exploration Results, Mineral Resources and Ore Reserves (JORC Code);
- Valuation of the Coal Reserves in accordance with the guidelines of the Code for the Technical Assessment and Valuation of Mineral and Petroleum Assets and Securities for Independent Expert Reports (VALMIN), and
- Preparation of a CPR and provision of drafts of the CPR to Project personnel to ensure factual accuracy and reasonableness of assumptions.

The comments and forecasts in this CPR are based on information compiled by enquiry and verbal comment from BHP Billiton and Project personnel. Where possible, this information has been checked with hard copy data or by comment from more than one source. Where there was conflicting information on issues, RPM used its professional judgment to assess the issues.

1.4 Site Visits and Inspections

A site visit was conducted by RPM's Study Team to the Project's operations. The site visit was undertaken on 21st October to 23rd October, 2014 by:

- Mr David McMillan – Principal Underground Coal Mining Engineer;
- Mr Shaun Ayshford – Principal Coal Geologist;
- Mr Peter Smith – Principal Environmental Consultant;
- Mr Ben Hall – Executive Consultant (equipment and infrastructure);
- Ms Lucy McMillan – Principal Coal Processing Consultant; and,
- Mrs Shoba Keys – Principal Mining Engineer.

During the site visits the Team inspected the Appin, West Cliff and Dendrobium mines, the coal preparation plants and conducted general inspections of the Project area. The Team had open discussions with the Client's personnel on technical aspects relating to the relevant issues that influence the life of mine operations. The Client's personnel were cooperative and open in facilitating RPM's work.

1.5 Information Sources

This CPR is based upon the information provide within, and RPM's review of, numerous technical studies and operating forecasts for the Project provided by Illawarra Coal.

1.6 Illawarra Coal FY2014 Coal Resources and Coal Reserves

This report includes information on Coal Resources (inclusive of Coal Reserves) as reported by: H Kaag (MAusIMM) - Appin, West Cliff, Dendrobium and Cordeaux, and Coal Reserves as reported by: M Rose (MAusIMM) - Appin, West Cliff and Dendrobium. The information is extracted from the report titled BHP Billiton 2014 Annual Report and is available to view on www.bhpbilliton.com.

The Competent Persons for the Coal Resources and Coal Reserves are full-time employees of BHP Billiton at the time of reporting, unless otherwise stated, and have the required qualifications and experience to qualify as Competent Persons for Coal Resources under the JORC Code. The Competent Persons verify that the report is based on and fairly reflects the Coal Resources and Coal Reserves information in the supporting documentation and agree with the form and context of the information presented.

The Client confirms that it is not aware of any new information or data that materially affects the information included in the original market announcements and, in the case of estimates of Coal Resources and Coal

Reserves, that all material assumptions and technical parameters underpinning the estimates in the relevant market announcements continue to apply and have not materially changed. The Client confirms that the form and context in which the Competent Persons' findings are presented have not been materially modified from the original market announcements.

1.7 Study Team

1.7.1 Competent Person (ESMA Recommendations)

This Competent Person Report has been prepared by or under the supervision of David McMillan. David qualifies as a Competent Person as per the ESMA recommendations as:

- He has is professionally qualified and a member in good standing of the Australasian Institute of Mining and Metallurgy ("AusIMM") which is a an appropriate recognised professional association, institution or body relevant to the activity being undertaken, and who is subject to the enforceable rules of conduct;
- He possess the required competency requirements as prescribed by the relevant codes and organisation (as listed in Appendix I of ESMA);
- He has greater than five years' relevant professional experience in the estimation, assessment and evaluation of the type of mineral or fluid deposit being or to be exploited by Illawarra Coal and to the activity which that person is undertaking; and,
- He is independent of the Client, its directors, senior management and its other advisers; has no economic or beneficial interest (present or contingent) in the Client or in any of the mineral assets being evaluated and is not remunerated by way of a fee that is linked to the admission or value of the issuer.



David McMillan

**Principal Underground Coal Mining Consultant
MEng (Mining), RPEQ (14248), MAusIMM (CP), ARSM**

David's career spans twenty-three years, with over seventeen years of operational experience. He has extensive practical underground and open-cut coal experience working in operational, managerial and technical roles. David's operational experience extends over three continents and covers potash and coal mining. David has been with RPM for six years and currently holds the title of Executive Consultant. During this time he has lead teams in the delivery of major pre-feasibility and feasibility studies for underground coal operations in New South Wales and Queensland. He has also completed numerous technical reviews and mine optimisation studies.

1.7.2 Valuation Expert

The Mineral Reserve Valuation has been prepared by Mr Greg Eisenmenger. Greg has prepared the valuation in accordance with VALMIN. Greg meets the requirements as a VALMIN Expert as:

- He is competent in and have had at least ten years of relevant and recent General Mining Experience in the Mining Industry;
- He has greater than five years of relevant and recent experience in the assessment and/or valuation of Mineral or Petroleum assets; and,
- Greg is a member in good standing of the Australasian Institute of Mining and Metallurgy (AusIMM) which is an appropriate recognised professional association, institution or body relevant to the activity being undertaken, and who is subject to the enforceable rules of conduct.



Greg Eisenmenger

Executive Consultant
BE (Civil IIB Hons), MAusIMM

Greg has more than 35 years of international coal mining industry experience, with a strong technical and general management background. Greg's specific general management capabilities are drawn from involvement in the management of large mining contracts in open cut coal, management of in-house technical and engineering programs, management of the annual budgeting process for individual mine sites at the business unit level, and project development involving project definition, tendering, evaluation, award and construction supervision. Currently as Executive Consultant with RPM in the mining advisory space, managing coal mining project feasibility studies and undertaking independent technical reviews of mining assets being targeted by potential investors.

VALMIN Technical Specialist

David McMillan has acted as a Technical Specialist to Greg Eisenmenger for the information relating to underground coal mining practices, production, operating and capital costs. David takes responsibility for this information as it appears in this Competent Persons Report and as it has been applied to the Coal Reserves Valuation.

1.7.3 Project Team

The ITR Team members who have compiled this report included:

- Mr Shaun Ayshford – Shaun was responsible for the review of the BSO geology, geological datasets and Coal Resource estimates;
- Mr Brendan Stats – Brendan was responsible for the review of the Dendrobium and Cordeaux geology, geological datasets and Coal Resource estimates;
- Mr Aaron Simonis – Aaron was responsible for the review of the BSO mine plan and Coal Reserve estimates;
- Mr David McMillan – David was responsible for the supervision of all Team members, their work and the compilation of the Report. Dave also completed the review of the Dendrobium mine plan and Coal Reserve. David assumes responsibility of the Report as Competent Person;
- Mrs Shoba Keys – Shoba was responsible for the gas assessment of the Project;
- Ms Lucy McMillan – Lucy was responsible for the review of the coal process plants and Project logistics;
- Mr Ben Hall – Ben was responsible for the review of Project infrastructure and equipment and associated cost estimates;
- Mr Peter Smith – Peter was responsible for the review of the Project approvals, licences and environment;
- Mr Greg Eisenmenger – Greg was responsible for the Valuation of the Coal Reserves; and,
- Mr Dan Peel – Dan was responsible for RPM's review of the CPR.

1.8 Limitations and Exclusions

RPM's review was based on various reports, plans and tabulations provided by the Client or the Project either directly from the mine site and other offices, or from reports by other organisations whose work is the property of the Client or the Project. Neither the Client nor the Project have advised RPM of any material change, or event likely to cause material change, to the operations or forecasts since the date of asset inspections.

The work undertaken for this Report is that required for a technical review of the information, coupled with such inspections as the Team considered appropriate to prepare this Report.

It specifically excludes all aspects of legal issues, commercial and financing matters, land titles and agreements, except such aspects as may directly influence technical, operational or cost issues and where applicable to the JORC Code guidelines.

RPM has specifically excluded making any comments on the competitive position of the Relevant Asset compared with other similar and competing producers around the world. RPM strongly advises that any potential investors make their own comprehensive assessment of both the competitive position of the Relevant Asset in the market, and the fundamentals of the coal markets at large.

1.8.1 Limited Liability

This Report has been prepared by RPM for the purposes of the Client in respect of the proposed listing on the Main Board of London Stock Exchange, the Johannesburg Stock Exchange and the Australian Securities Exchange and is not to be used or relied upon for any other purpose. RPM will not be liable for any loss or damage suffered by a third party relying on this report or any references or extracts therefrom contrary to the purpose (regardless of the cause of action, whether breach of contract, tort (including negligence) or otherwise, unless and to the extent that RPM has consented to such reliance or use.

1.8.2 Responsibility and Context of this Report

RPM has relied on the information provided by the Client and, other than to the extent required by the relevant reporting standards and/or listing rules, RPM has not carried out any form of audit, extensive examination, independent verification or due diligence investigation of the information provided. RPM accepts no liability for the accuracy or completeness of data and information provided to it by, or obtained by it from the Client or any third parties (including the Project), even if that data and information has been incorporated into or relied upon in creating this report. The report has been produced by RPM in good faith using information that was available to RPM as at the date stated on the cover page and is to be read in conjunction with the circular which has been prepared and forms part of the referenced listing.

This report contains forecasts, estimates and findings that may materially change in the event that any of the information supplied to RPM is inaccurate or is materially changed. RPM is under no obligation to update the information contained in the report

1.8.3 Indemnification

The Client has agreed to indemnify RPM against any claims, liabilities, damages, losses, and expenses that RPM may have to the Client or any third party arising out of RPM's reasonable reliance on the information supplied to RPM by the Client or any of the Client's representatives that is materially inaccurate or incomplete; however, such indemnification will not apply to such claims, damages, losses or expenses to the extent caused by RPM's breach of contract, gross negligence or wilful misconduct.

1.8.4 Mining Unknown Factors

Other than to the extent required pursuant to the relevant listing rules, the Prospectus Rules, ESMA Recommendations and reporting standards, the findings and opinions presented herein are not warranted in any manner, expressed or implied. The ability of the operator, or any other related business unit, to achieve forward looking production and economic targets is dependent upon numerous factors that are beyond RPM's control and which cannot be fully anticipated by RPM. These factors include site specific mining and geological conditions, the capabilities of management and employees, availability of funding to properly operate and capitalise the operation, variations in cost elements and market conditions, developing and operating the mine

in an efficient manner, etc. Unforeseen changes in legislation and new industry developments could substantially alter the performance of any mining operation.

1.8.5 Capability and Independence

RPM provides independent advisory services to the mining and finance sectors. Within its core expertise it provides independent technical reviews, resource evaluation, mining engineering and mine valuation services to the resources and financial services industries.

RPM has independently assessed the Project by reviewing pertinent data, including resources, reserves, manpower requirements and the life of mine plans relating to productivity, production, operating costs and capital expenditures. All opinions, findings and conclusions expressed in this Report are those of RPM and its specialist advisors.

Drafts of this report were provided to the Client, but only for the purpose of confirming the accuracy of factual material and the reasonableness of assumptions relied upon in this Report.

RPM has been paid, and has agreed to be paid, professional fees based on a fixed fee estimate for its preparation of this Report. RPM's remuneration is not dependent upon the findings of this report nor on the outcome of the proposed listing.

The authors of this CPR do not have any economic or beneficial interest (present or contingent) in:

- The Project, securities of the companies associated with the Project or that of the Client; or
- Any right or options in the Project; or
- The outcome of the proposed listing.

This CPR was compiled on behalf of RPM by the signatories to this Report, details of whose qualifications and experience are set out in **Annexure A** to this CPR and each has consented to the matters based on their information in the form and context in which it appears.

2 Project Overview

The Project consists of three operating underground mines feeding two coal preparation plants producing both metallurgical and thermal coal. With a long operating history the assets are well understood and operating practices are mature. The Project has two main operations, namely the BSO and the Dendrobium Operation. With well-established regional infrastructure in place the Project is supported by both road and rail facilities as well as a deep-water port at Port Kembla.

The two operations produced in excess of 10 Mt of Run of Mine “ROM” coal and 6 Mt of Product Coal in FY2014, and are forecast to increase production to 12 Mt ROM and 9 Mtpa Product Coal in FY2015. Production is planned to reduce to 7 to 8 Mtpa ROM from FY2024 when Dendrobium ceases operations with a further reduction to 3.5 Mt to 4 Mt ROM from FY2034 when the Appin Mine reverts to a single longwall operation. The current life of asset plan forecasts a 25 year mine life based on the current Coal Reserves.

Located 40 km from Port Kembla, the West Cliff Preparation Plant in the BSO has a throughput capacity of 7.5 Mtpa and relies largely of road transportation to transport Product Coal to the port and the BlueScope Steelworks. The Dendrobium Preparation Plant is located within the BlueScope Steelworks and has a capacity of 5.1 Mtpa and connects to the Dendrobium mine site via a dedicated 8 km long rail line.

Section 2.2 gives a brief over of each operation and the mine and offsite infrastructure.

2.1 Project Location and Access

The Illawarra Coal assets are located near Wollongong in the Illawarra Region of NSW, a coastal region situated approximately 75 km to 90 km south-west of Sydney. The location and layout of the BSO and the Dendrobium Operation are shown in Figures 2-1, 2-2 and 2-3.

2.2 Project Description

2.2.1 Bulli Seam Operation

The BSO consists of the Appin and West Cliff Mines and the West Cliff Coal Preparation Plant. ROM Coal from both BSO mines is processed at the West Cliff Coal Preparation Plant.

Appin Mine

The Appin Mine is owned and operated by Endeavour Coal Pty Ltd. (“ECPL”), a wholly owned subsidiary of Illawarra Coal which is, in turn, wholly owned by BHP Coal Holdings Pty Ltd which is, in turn, wholly owned by BHP Billiton Ltd.

The Appin Mine was formed when Appin Colliery and Tower Colliery merged in 2003 at which time the underground infrastructure, roadways, conveyor and ventilation systems of the Appin and Tower Collieries were combined.

Appin Colliery and Tower Colliery commenced operations in 1962 and 1978 respectively. Tower Colliery completed extraction of 20 longwall blocks between 1978 and September 2002. The Tower Colliery was recently redeveloped underground to establish mining operations in the current longwall Area 7 mining domain of the Appin Mine.

Key areas associated with the current Appin Mine operations include:

- The Appin East pit top site;
- The Appin West pit top site;
- The Appin East No. 1 and No. 2 fan site;

- The Appin West No.3 fan site;
- No. 6 fan site (under construction); and,
- The Douglas Park substation site.

Appin Mine extracts coal from the Bulli Seam and consists of two separate pit top operational sites; Appin East and Appin West. The Appin West site (formally Tower Colliery) is currently the primary access for mining activity in Area 7, the current mining domain where a single longwall is operating.

Appin Mine is currently progressing work on the establishment of a new longwall domain, Area 9 Project, to provide continued operation of two Bulli Seam longwalls in FY2016 and beyond. The commencement of mining in Area 9 is timed to match the completion of mining in West Cliff Area 5.

ROM coal is transported underground to a drift conveyor at the Appin East site from where it is trucked to the West Cliff Coal Preparation Plant. Occasionally, coal from Appin East is trucked to the Dendrobium Coal Preparation Plant for processing.

West Cliff Mine

West Cliff Mine is also owned and operated by ECPL with underground coal mining operations commencing in 1997. Prior to this, West Cliff was operated by Kembla Coal and Coke Pty Limited ("KCC").

Production from the West Cliff Mine is currently sourced from the Bulli Seam in Area 5 via a single longwall. ROM coal is processed on site at the West Cliff Coal Preparation Plant, along with the ROM coal from Appin. Product coal is transported via road to the BlueScope Steelworks and the PKCT. Coal rejects are emplaced on site unless directed to an approved alternate usage. Mining in Area 5 is nearing completion with the longwall scheduled to complete the current panels in 2016.

Key areas of the West Cliff Colliery site include:

- The pit top (South site); and,
- The West Cliff Emplacement Area and Coal Preparation Plant (CCP) at the North site.

In addition, the West Cliff Mine encompasses the redundant North Cliff Mine site within the Dharawal National Park Area.

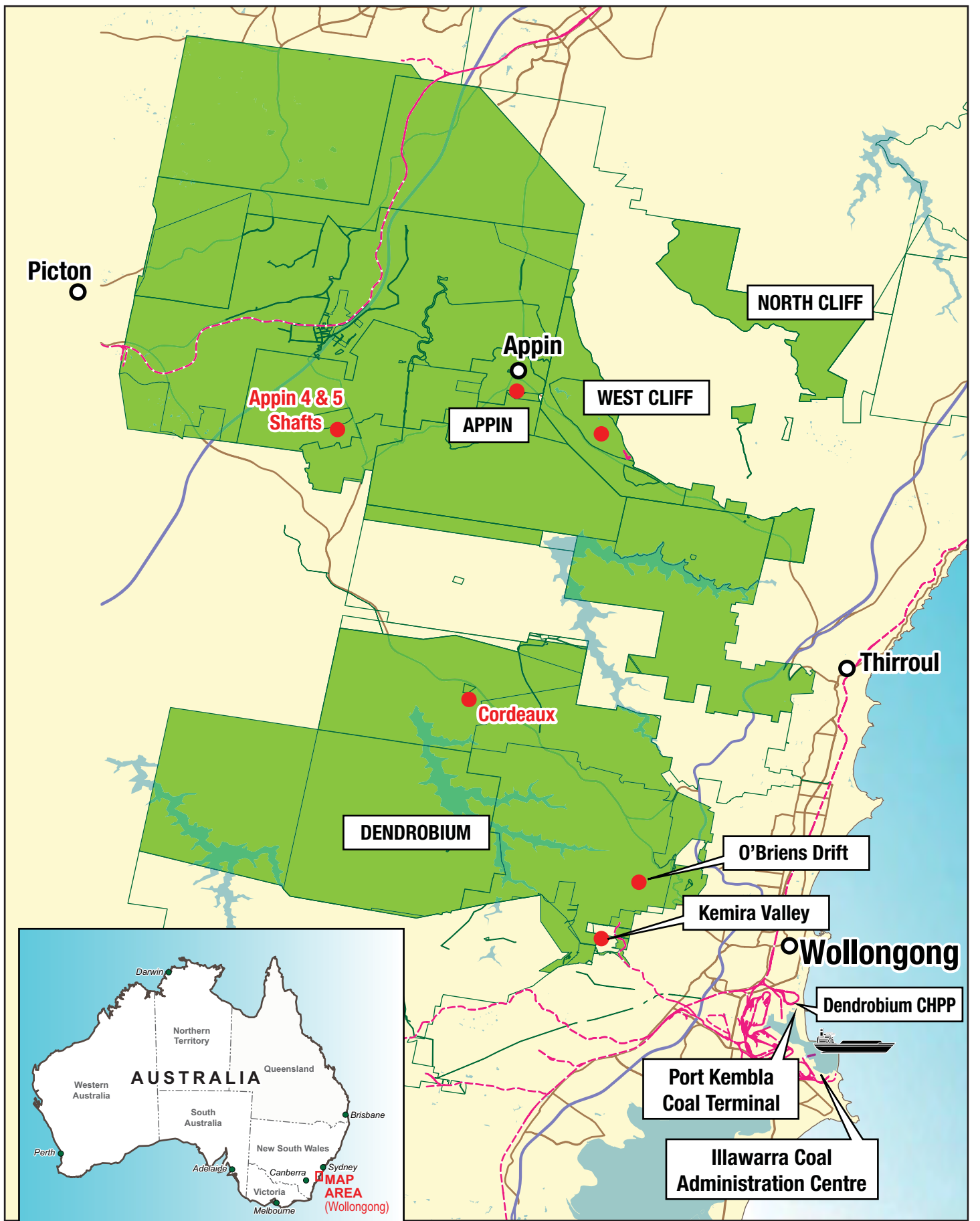

Runge Pincock Minarco

LEGEND	
	Holdings Boundaries
	Pit Tops
	Rail
	Roads
	Motorways
	Lakes

0 10 km

DO NOT SCALE THIS DRAWING - USE FIGURED DIMENSIONS ONLY. VERIFY ALL DIMENSIONS ON SITE.

CLIENT	PROJECT	
 resourcing the future Illawarra Coal	NAME ILLAWARRA COAL - COMPETENT PERSONS REPORT	
	DRAWING ASSET LOCATION PLAN	
FIGURE No. 2.1	PROJECT No. ADV-SY-04120	Date March 2015

2.2.2 Dendrobium Operation

Dendrobium Mine

Dendrobium Mine is an underground mining operation owned and operated by Dendrobium Coal Pty Ltd (DCPL), a wholly owned subsidiary of BHP Billiton. Dendrobium extracts coal from the Wongawilli Seam of the Illawarra Coal Measures.

The pit top facilities have been developed on the site previously known as Nebo Colliery, which was combined with Wongawilli Colliery in 1993 to form Elouera Colliery. The Nebo pit top site was relinquished from the ownership and responsibility of Elouera Colliery in December 2001 to enable Dendrobium Mine to acquire formal responsibility, ownership and identity of the site.

A single longwall is currently mining in Area 3B. ROM coal from Dendrobium is transported via rail and processed at the Dendrobium Preparation Plant which is within the BlueScope's Steelworks. All coal rejects are transported by road to the West Cliff emplacement site unless directed to an approved alternate usage.

Dendrobium Coal Preparation Plant

The Dendrobium Coal Preparation Plant processes coal railed from the Dendrobium Mine or occasionally coal trucked from the BSO. The plant has a feed capacity of 720 tph and is designed to produce two separate products; a coking coal and a thermal coal product.

The plant sits entirely within the footprint of the BlueScope Steelworks which limits the stockpiling space and prohibits the disposal of the preparation plant coal waste on site.

The Cordeaux Mine

The Cordeaux Mine exhausted the Bulli Seam Coal Reserves and was placed in care and maintenance in 2001. There are substantial Coal Resources in the underlying Wongawilli Seam and these have been identified for potential long-term extraction by the Dendrobium operation.

2.2.3 Exploration Titles

In addition to the mining leases discussed above, Illawarra Coal also holds 15 Coal Authorisations or Exploration Licences. Authorisations 143, 338 and 374 cover the Cordeaux and Dendrobium Holdings. Nine Authorisations cover Appin and West Cliff Holdings. All Authorisations held by Illawarra Coal are shown in Figure 2-1 and listed in **Section 3**.

These titles are held by Illawarra Coal, ECPL and DCPL. ECPL and DCPL are wholly owned subsidiaries of Illawarra Coal. The Authorisations and Exploration Licences allow Illawarra Coal access to the land for the purpose of exploration subject to adequate compensation to the landholder.

2.2.4 Illawarra Coal Head Office

The Illawarra Coal assets include a head office in the city of Wollongong. There are currently approximately 120 employees working in the office and provide technical, management and business support functions.

2.3 Regional Environment

2.3.1 Geography

The city of Wollongong and surrounding area has a distinct geography. It lies on a narrow coastal plain flanked by the Tasman Sea to the east and a steep sandstone precipice known as the Illawarra Escarpment to the west.

The escarpment ranges between 150 m and 750 m above sea level, with locally famous mountains such as Mount Keira (464 m), Mount Kembla (534 m), Broker's Nose (440 m) and Mount Murray (768 m) to the south. The escarpment contains coal measures strata with adit entrances to many coal mines having been established along the slopes of the escarpment throughout Wollongong. Suburbia encroaches on the escarpment's lower slopes in some areas, but the majority remains in a relatively natural state forested with dry

sclerophyll and pockets of temperate rainforest. The escarpment is largely protected by a State Conservation Area and local scenic protection zoning.

To the south, the coastal plain reaches its maximum extent around Albion Park where it incorporates a large coastal saltwater lagoon called Lake Illawarra, separated from the Pacific Ocean by a long sandy spit.

The coastal strip consists of highly fertile alluvium, which made Wollongong attractive to agriculturists in the nineteenth century. It contains many hills including the foothills of the escarpment's lower slopes. The coastal strip is traversed by several short but flood-prone and fast-flowing streams and creeks such as Para Creek, Allans Creek, Nostaw Ravine, Jimbob Creek, Mullet Creek and Macquarie Rivulet.

The coastline consists of many beaches interrupted by prominent and rocky headlands. In places these headlands have been excavated or extended to create artificial harbours at Wollongong, Port Kembla, Shellharbour and Kiama. Just off the coast south of Wollongong centre, near Port Kembla, lies a group of five islands known collectively as The Five Islands. The islands are a wildlife refuge.

2.3.2 Climate

The Illawarra Region experiences an oceanic climate with average maximum temperatures varying from 17 °C in winter to 26 °C in summer tempered by sea breezes. The highest recorded temperature is 44.1 °C in January and the lowest 0.8 °C in July.

Rainfall is fairly evenly distributed throughout the seasons, with a bias to the first half of the year. It is often associated with orographic lift caused by the escarpment. Short high intensity rainfall events may happen at any time of the year and can lead to local flooding. The Illawarra Region also experiences thunderstorms during the warmer months bringing lightning, heavy rain and occasionally hail. Yearly rainfall is influenced by the El Niño-Southern Oscillation. July and August are known as the windy months, with westerly gales that can gust at over 100 km/h.

2.3.3 Industry

The main industries in the area have traditionally been farming, coal mining and steel making. Australia's largest steel-works, BlueScope Steel, operates at Port Kembla. The area, especially around Port Kembla and Wollongong, was once known for its mainly industrial jobs, but since the 1990s commerce has played an increasing role in the city, overtaking industry in many areas. Other notable industrial operations in the area are Port Kembla Copper and GrainCorp.

2.4 Regional and Local Infrastructure

The Illawarra Region has a population of 457,000 with Wollongong being the largest city with a population of 292,000.

Wollongong and the Illawarra Region are linked to Sydney by the Southern Freeway; to the west by the Illawarra Highway and Picton Road; and to the south by the Princes Highway.

Wollongong is served by the South Coast railway line. Passenger rail services on this line connect the centres of Nowra and Kiama to the south and Sydney to the north. A branch line connects suburbs between the Wollongong CBD and Port Kembla. Freight services connect Sydney markets with Port Kembla and the Manildra factory at Bomaderry. The Southern Highlands line is used primarily for freight, providing an important bypass for Sydney's congested rail network.

Wollongong is serviced by Illawarra Regional Airport.

Port Kembla Harbour is a major export location for coal mined in the southern and western regions of NSW. As part of the NSW State Government's plan to divert ships from Sydney, the port has received significant upgrades and infrastructure including a new Maritime Office and many jobs have been created as the need for port logistics grows.

The area has a number of local schools and a university.

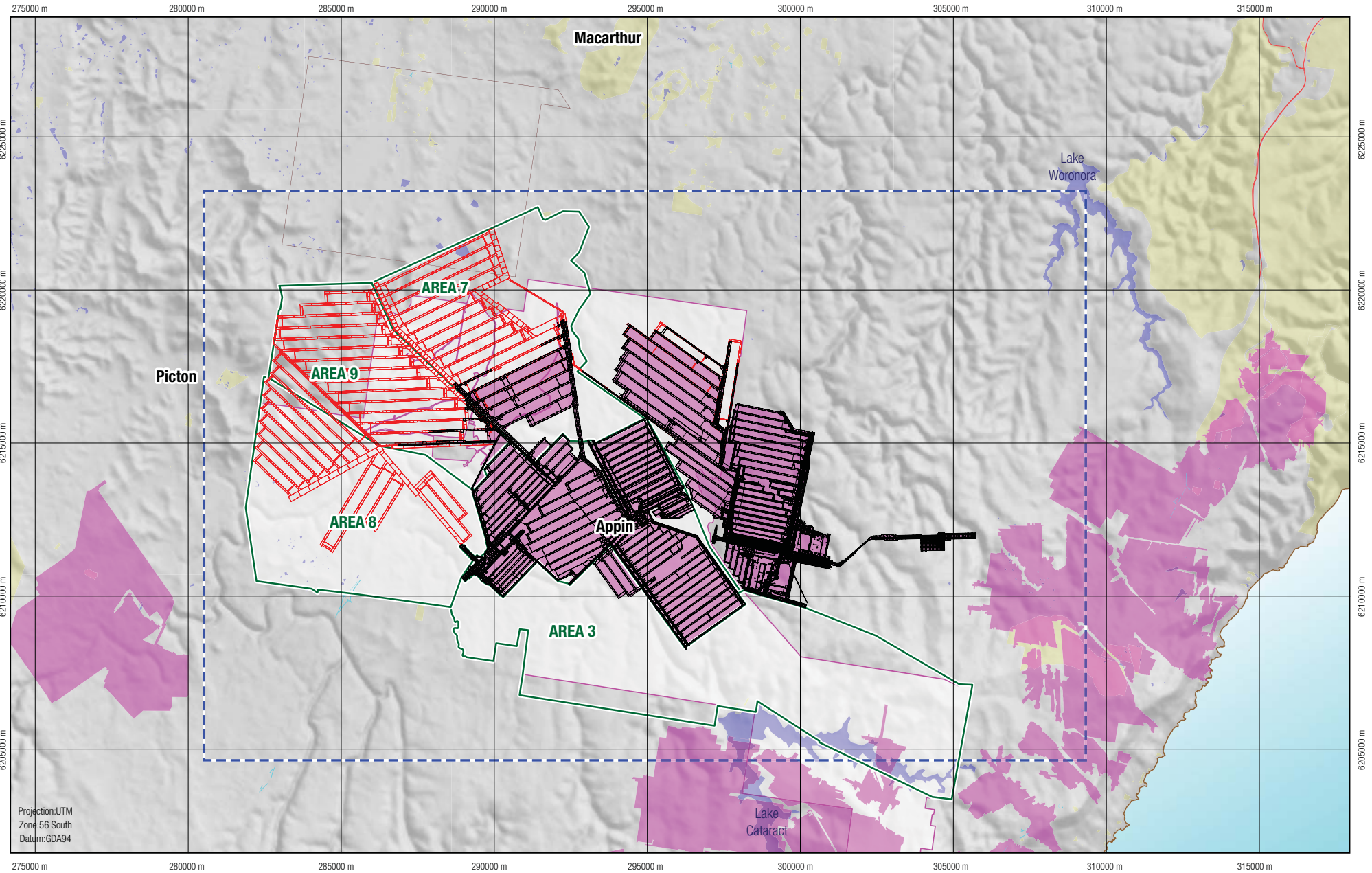

Projection: UTM
 Zone: 56 South
 Datum: GDA94

LEGEND

- CCL767 boundary
- Development Consent Boundary
- Model Limit
- National Park
- Mined Out Areas
- Bulli Seam Workings
- Current Mine Plan



CLIENT



PROJECT

NAME		
ILLAWARRA COAL - COMPETENT PERSONS REPORT		
DRAWING		
SITE LOCATION PLAN - BSO		
FIGURE No. 2.2	PROJECT No. ADV-SY-04120	Date March 2015

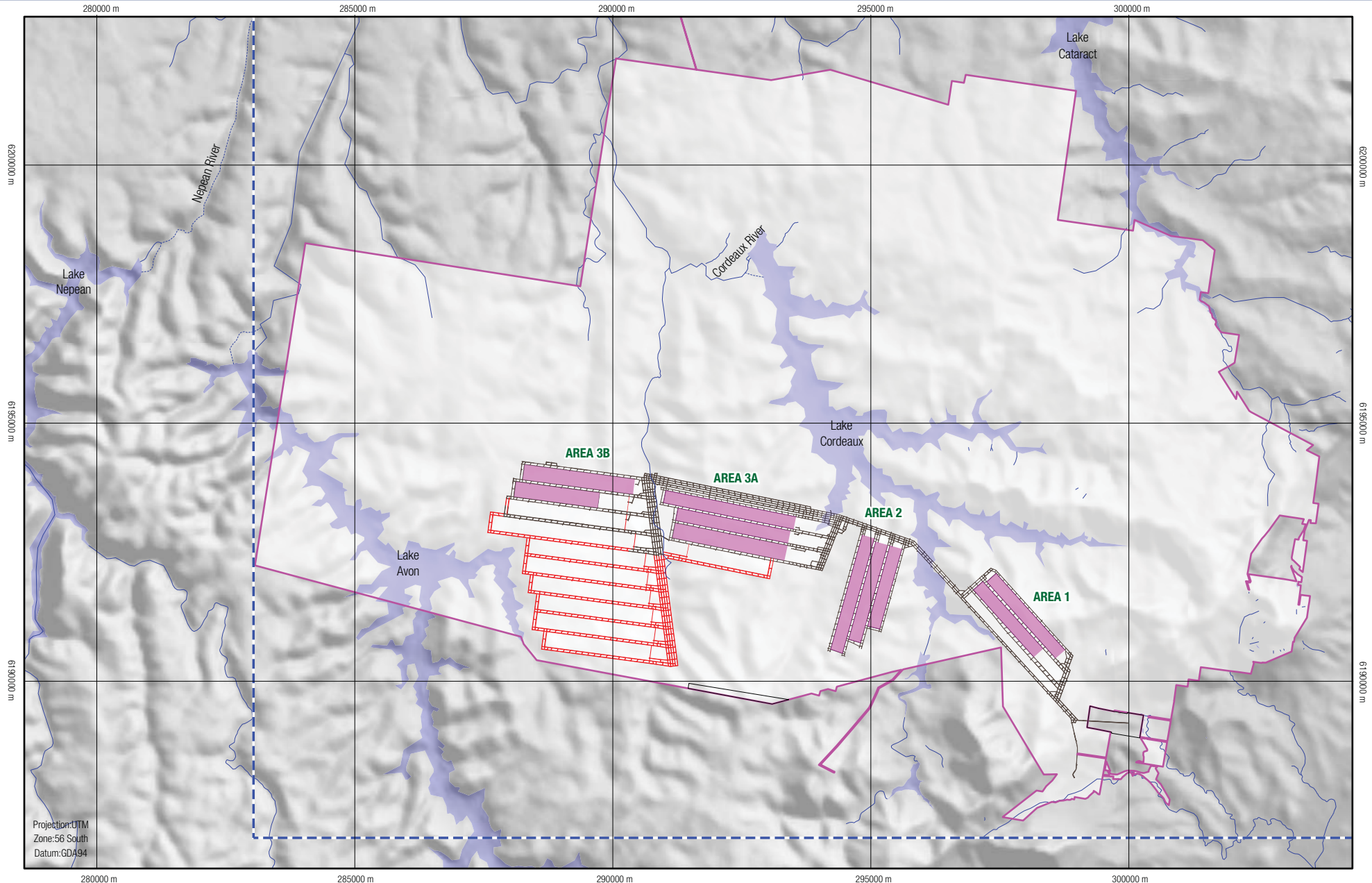

Projection: UTM
 Zone: 56 South
 Datum: GDA94

LEGEND	
CCL768 boundary	Wongawilli Seam Workings
Model Limit	Current Mine Plan
Mined Out Areas	

0 5
 DO NOT SCALE THIS DRAWING - USE FIGURED DIMENSIONS ONLY. VERIFY ALL DIMENSIONS ON SITE. km

CLIENT resourcing the future Illawarra Coal	PROJECT NAME ILLAWARRA COAL - COMPETENT PERSONS REPORT	
	DRAWING SITE LOCATION PLAN - DENDROBIUM	
	FIGURE No. 2.3	PROJECT No. ADV-SY-04120

3 Licences and Permits

Illawarra Coal holds numerous current mining tenements including mining leases, coal leases, consolidated coal leases, mining purposes leases, and exploration licences (authorisations). These enable Illawarra Coal operations including underground mining operations, major surface facilities and coal handling, shafts, gas management operations, electrical infrastructure, waste coal emplacement, and exploration activity.

3.1 Mining Tenements

All key mining tenements are currently valid despite some awaiting renewal, particularly in relation to CCL768 at Dendrobium and for several exploration licences associated with BSO. The administrative delay in the granting of tenement renewals is not uncommon in recent years in NSW. However, full validity of the tenement remains with the titleholder unless the renewal application has been formally refused.

Detailed mining approvals are in place as required under the conditions of Mining Leases, specifically in relation to Mining Operations Plans, Subsidence Management Plans and Extraction Plans lodged by Illawarra Coal.

All relevant licences and authorisations held by Illawarra Coal are listed in Table 3-1 and Table 3-2. Further details on tenements, approvals and licences held by the BSO and the Dendrobium Operation are provided in **Section 10**.

Table 3-1 - Illawarra Coal Mining Leases

Tenement	Description	Holder	Area	Expiry Date	Renewal Period (Years)
CCL767	Appin	Endeavour Coal	207.8 sq.km	8/07/2029	21
CCL768	Dendrobium, Cordeaux	Illawarra Coal	185.6 sq.km	18/10/2010*	21
CCL724	West Cliff	Endeavour Coal	3,721 ha	18/12/2031	21
CL381	West Georges River Nose	Endeavour Coal	58 ha	24/10/2033	21
CL388	Appin West covering Cataract tunnel and canal	Endeavour Coal	47.2 ha	22/01/2034	21
ML1382	Tower No. 3 Shaft - surface only	Endeavour Coal	1.184 ha	19/12/2016	21
ML1433	65 ha of roads in Appin West and Camden areas	Endeavour Coal	65 ha	23/07/2019	21
ML1473	MPL for West Cliff surface	Endeavour Coal	1082 sq.m	20/11/2021	21
ML1510	Stockpile	Dendrobium Coal	44.03 ha	23/04/2023	21
ML1566	Dendrobium Shafts No.2 & 3	Dendrobium Coal	5.262 ha	6/10/2026	21
ML1574	Lease adjoining Appin Lease obtained as a result of lease exchange with NRE	Endeavour Coal	419.4 ha	30/12/2023	15
ML1678	Small un-held areas within CCL767	Endeavour Coal	40.2 ha	27/09/2033	21

Source: Supplied by Illawarra Coal.

Note: * Indicates a renewal has been sought.

3.2 Exploration Titles

All exploration titles are coincident with the CCL mining leases except for three; A248, EL4470 and EL7249. The first two titles cover an area of approximately 100 sq.km to the north of the Appin and West Cliff Mine Leases to facilitate exploration in this area.

A248 and EL4470 are overlain to a large extent by four Petroleum Production Licenses (PPL1, PPL2, PPL4 and PPL6 held by AGL Upstream Investments Pty. Ltd. ("AGL")). These give AGI rights to the production of petroleum including methane gas contained within the coal seams. An agreement which is satisfactory to both Illawarra Coal and AGI would need to be finalised before a coal mining lease or Development Consent could be granted. Such an agreement was reached during FY2012 for a portion of the coincident areas and this agreement sets a precedent for future agreements. As a result Illawarra Coal has declared Coal Resources for areas of coincident title.

Table 3-2 - Illawarra Coal Exploration Leases

Authorisation	Holding Company	Area (sq.km)	Renewal due	Renewal period (years)
A143	Dendrobium Coal	49.34	7/11/2013*	5
A199	Endeavour Coal	10.72	27/06/2014**	5
A201	Endeavour Coal	4.84	27/06/2014**	5
A248	Illawarra Coal	55.92	19/12/2015	3
A306	Endeavour Coal	14.77	27/06/2014**	5
A312	Endeavour Coal	29.1	10/08/2018*	4
A338	Endeavour Coal	35.64	8/10/2014**	5
A370	Endeavour Coal	31.29	27/06/2014**	5
A374	Dendrobium Coal	38.35	24/10/2017	4
A395	Endeavour Coal	5.71	10/08/2018**	5
A396	Endeavour Coal	72.25	27/06/2014**	5
A397	Endeavour Coal	4.07	27/06/2014**	5
A432	Endeavour Coal	33.06	31/08/2018**	5
EL4470	Illawarra Coal	48.45	19/12/2015	3
EL7249	Illawarra Coal	0.32	25/11/2014	3

Source: Supplied by Illawarra Coal.

Note: * offer to renew received, awaiting final instrument

** indicates a renewal has been sought.

3.2.1 Environmental and Operating Permits

Illawarra Coal's key mining operations, BSO and Dendrobium, currently hold separate development consents under the *NSW Environmental Planning and Assessment Act 1979* (EP&A Act). These land use approvals are essential prerequisites for the grant of a Mining Lease under the *Mining Act 1992*.

Prior to these planning consents being granted, Illawarra Coal's operations held "existing use rights" for mining under the planning law. The current consents apply to aggregated operations compared to historical mining operations. Other minor approvals and licences are in place as required throughout the operations for various facilities and activities such as shafts and gas drainage.

The BSO, comprising the continuation of mining at Appin Mine and West Cliff Mine, was approved by the Planning Assessment Commission as delegate for the NSW Minister for Planning and Infrastructure on 22nd December 2011 and expires on 31st December 2041. This approval allows the extraction of up to 10.5 Mtpa of ROM coal (or transport of up to 9.3 Mtpa of Product Coal) from the site.

Subsidiary permits and approvals for BSO include an Environmental Protection Licence (EPL2504) and detailed mining approvals for extraction of LW37 and 38 in West Cliff Area 5 and LW901 to 904 in Appin Area 9.

The Dendrobium approval was granted by the Minister for Planning on 20th November 2001. Successive modifications to this consent were subsequently approved. The most recent consent granted by the Planning Assessment Commission on 8th December 2008 (known as MOD 6) related to Area 3 modifications and consent simplification and allowed mining until 31st December 2030. The extraction limit for mining is up to 5.2 Mtpa of ROM coal.

Key subsidiary approvals were later received from the Department of Resources and Energy and Department of Planning and Environment (DP&E) for the Subsidence Management Plan to permit mining of Area 3A and for LW9 to 13 in Area 3B.

PKCT Ltd is one-sixth owned by Illawarra Coal but is not part of the assets under review in this report. PKCT Ltd is responsible for port operations. Relevant operating approvals and licences, principally Major Project Approval 08_0009 and Environment Protection Licence (EPL) 1625 are held in relation to the PKCT operations.

The six shareholders are responsible for funding (on a pro rata basis of port throughput) environmental monitoring and management tasks including any environmental improvement works at PKCT for the purposes of site restoration and regulatory compliance as may be required under the terms of its approvals and licences.

3.2.2 Water Rights

Water-related approvals and licences are in place across the Illawarra Coal operations.

The BSO and Dendrobium Operation involve some mining within the catchments of the Sydney drinking water supply system.

Water usage and management as well as potential impacts on natural water features (rivers, ponds, swamps and waterfalls) and built water infrastructure (dams, canals, and pipelines) are addressed through the assessment and conditioning of the development consent and subsidence management plan processes.

Specific water and groundwater approvals are in place in relation to key mining and exploration activity including aquifer interference approval and access licence.

While water supply is not a critical constraint on the operations, an overall aim of Illawarra Coal is to minimise consumption of fresh water supplied from the Sydney drinking water catchment. Illawarra Coal operations collect, treat and/or recycle water encountered in underground mining or collected in surface runoff containment facilities. Goaf areas are also utilised where practicable for storage of surplus underground mine water.

Water stewardship procedures implemented by Illawarra Coal include tracking and reporting on its water use and impacts as required under site regulatory requirements and in accordance with the Minerals Council of Australia's voluntary Water Accounting Framework.

4 Geology

4.1 Regional Geology

Illawarra Coal's assets are located in the southern portion of the Sydney Basin within the Southern Coalfield. There is extensive mining and exploration history within the Southern Coalfields, with the first commercial mining of coal commencing around 1848. Consequently the geology of the Southern Coalfield is well understood and the summary provided below is extracted from 'A Compilation of the Geology of the Southern Coalfield, R.S. Moffitt, 2000'.

The geology of the Southern Coalfield includes the Permian Shoalhaven Group and Illawarra Coal Measures and the overlying Triassic Narrabeen Group and Hawkesbury Sandstone. The economic coal seams of interest are hosted within the Illawarra Coal Measures. The Illawarra Coal Measures contain a number of coal seams; the two key economic seams developed in the Project area are the Bulli and Wongawilli Seams.

The regional stratigraphy is shown in a generalised stratigraphic column of the Southern Coalfields shown in Figure 4-1.

The Sydney Basin is the southern part of the structural Sydney-Bowen Basin, a major structural basis extending northwards from Batemans Bay in the south to the central coastal region of Queensland. The major structure of the Southern Coalfield is essentially a linear zone trending north-northeast and south-southwest forming a prominent physiographic feature, including a number of monocline and fault systems. Within the Southern Coalfield, the most predominant regional structure identified is the 'Lapstone Structural Complex', which includes the Nepean Fault Zone in the south and the Lapstone Monocline in the north.

4.1.1 Deposit Geology and Stratigraphy

The full sequence of Triassic to Permian sedimentary units are present within the Project areas, including the Permian Shoalhaven Group, Illawarra Coal Measures and the overlying Triassic Narrabeen Group and Hawkesbury Sandstone.

The economic coal seams relevant to the Project areas are hosted within the Illawarra Coal Measures. The general stratigraphy of the Illawarra Coal Measures is shown in Figure 4-2 and a general description of the most relevant units is provided below:

- Bulli Coal is the uppermost coal unit in the Illawarra Coal Measures. It is extensively worked in the northern portions of the Southern Coalfield. The Bulli Seam is the main economic coal seam for the BSO. It averages approximately 2.6 m thick across Appin, gaining a maximum thickness of approximately 4.1 m. The Bulli Seam thins to approximately 1.4 m in the south eastern part of West Cliff and also south west of Appin. Overall, the coal thickness for the Bulli Seam is generally consistent across BSO in the mined out areas and planned areas of longwall mining;
- The Loddon Sandstone is generally between 7 m to 10 m thick;
- Balgownie Coal consists of high ash coal and carbonaceous shale and is generally less than 1 m thick;
- Lawrence Sandstone is 7 m to 11 m thick;
- Cape Horn Coal is a carbonaceous shale to bright coal, typically less than 0.5 m thick;
- Eckersley Formation consists of thin coals, minor carbonaceous shale, laminites and black shales;
- Wongawilli Coal ranges between 7 to 11 m thick and consists of inter-banded tuffs, carbonaceous shales and coal. The basal 4 m contains coal of economic potential and is currently mined at the Dendrobium Mine. The Wongawilli Coal is subdivided into 13 individual plies and 12 partings units and into three working sections as shown in Figure 4-3. The working sections are based on mining experience and are the most relevant division of the seam. The Second Machine Band working section is generally the target of mining at Dendrobium.

- Wongawilli Seam is present within the Appin and West Cliff areas, although a viable working section is not interpreted to occur in the area;
- American Creek Seam is a thin coal inter-bedded with carbonaceous claystone, and,
- Tongarra Coal is a thin coal inter-bedded with carbonaceous siltstone and claystone.

4.1.2 Structure

The structure over the Project area is relatively well defined based on the geological data available. Seam dips over the Project area are generally low (1° to 3°). There are localised variations in seam structures. Relatively steeply dipping strata occurring at the Dendrobium Mine between Areas 2 and 3 where dips reach 7° - 8° in an area associated with a small scale fault. The localised steeper dip zones are also often associated with underlying igneous intrusions and domes.

AGE	GROUP	SUBGROUP	West	FORMATION and Member	East			
TRIASSIC	WIANAMATTA GROUP			Bringelly Shale Minchinbury Sandstone Ashfield Shale				
		MITTAGONG FORMATION HAWKESBURY SANDSTONE						
	NARRABEEN GROUP	GOSFORD SUBGROUP			NEWPORT FORMATION GARIE FORMATION			
			CLIFTON SUBGROUP	COLO VALE SANDSTONE	KANGALOO SANDSTONE	BALD HILL CLAYSTONE BULGO SANDSTONE STANWELL PARK SANDSTONE SCARBOROUGH SANDSTONE WOMBARRA CLAYSTONE COAL CLIFF SANDSTONE		
		BULLI COAL						
					LODDON SANDSTONE Dural Sandstone Member Balmain Coal Member Penrith Sandstone Member			
					BALGOWNIE COAL LAWRENCE SANDSTONE			
					BURRAGORANG CLAYSTONE ECKERSLEY FORMATION Cape Horn Coal Member Hargrave Coal Member Woronora Coal Member Novice Sandstone			
				WONGAWILLI COAL Farmborough Claystone Member				
	PERMIAN	ILLAWARRA COAL MEASURES	SYDNEY SUBGROUP		KEMBLA SANDSTONE ALLANS CREEK FORMATION American Creek Coal Member DARKES FOREST SANDSTONE BARGO CLAYSTONE Huntley Claystone Member Austinmer Sandstone Member			
TONGARRA COAL								
				WILTON FORMATION Wangandery Sandstone Member Woonona Coal Member				
				MARRANGAROO CONGLOMERATE	THIRROUL SANDSTONE			
				ERINS VALE FORMATION				
				PHEASANTS NEST FORMATION Figtree Coal Member Unanderra Coal Member Berkeley Latite Member Minnamurra Latite Member Calderwood Latite Member Five Islands Latite Member				
				Gerrigong volcanic facies	BROUGHTON FORMATION Dapto Latite Member Cambewarra Latite Member Saddleback Latite Member Jamberoo Sandstone Member Bumbo Latite Member Kiama Sandstone Member Blow Hole Latite Member Westley Park Sandstone Member			
						BERRY SILTSTONE		
						NOWRA SANDSTONE		
						WANDRAWANDIAN SILTSTONE		
			SNAPPER POINT FORMATION					
			Yardboro and Tallong Conglomerate Members	Yarrunga Coal Measures PEBBLEY BEACH FORMATION				
			TALATERANG GROUP	Clyde Coal Measures				
				WASP HEAD FORMATION Pigeon House Creek Siltstone Member				
DEVONIAN		UNDIFFERENTIATED PALAEOZOIC (BASIN BASEMENT)	LAMBIE GROUP	Undifferentiated				
			MARULAN GRANITE	(Bullio, Bangadilly, and Greenstead Plutons.)				
			BINDOOK VOLCANIC COMPLEX	Rileys Ridge Rhyodacite Member, 'Joadja Creek Volcanics'				
SILURIAN		UNDIFFERENTIATED PALAEOZOIC (BASIN BASEMENT)	TARALGA GROUP	Undifferentiated WHIPBIRD CREEK FORMATION COBRA FORMATION KARALINGA FORMATION 'Attunga Sandstone Member' 'Tugalong Limestone'				
				BYRNES CREEK FORMATION				

LEGEND

CLIENT
 Illawarra Coal

PROJECT		
NAME ILLAWARRA COAL - COMPETENT PERSONS REPORT		
DRAWING GENERAL STRATIGRAPHY OF THE SOUTHERN COALFIELDS		
FIGURE No. 4.1	PROJECT No. ADV-SY-04120	Date March 2015

WEST

EAST

SYDNEY SUBGROUP	BULLI COAL			BULLI COAL		SYDNEY SUBGROUP
	BURRAGORANG CLAYSTONE			Dural Sandstone Member	LODDON SANDSTONE	
				Balmain Coal Member		
	ECKERSLEY FORMATION			BALGOWNIE COAL		
				LAWRENCE SANDSTONE		
	WONGAWILLI COAL			BURRAGORANG CLAYSTONE		
				Cape Horn Coal Member	ECKERSLEY FORMATION	
	KEMBLA SANDSTONE			Hargrave Coal Member		
				KEMBLA SANDSTONE		
	ALLANS CREEK FORMATION			Woronora Coal Member	WONGAWILLI COAL	
ALLANS CREEK FORMATION						
DARKES FOREST SANDSTONE		Novice Sandstone	DARKES FOREST SANDSTONE			
		DARKES FOREST SANDSTONE				
BARGO CLAYSTONE		Farmborough Claystone Member ('sandstone band' or '3 foot band')	BARGO CLAYSTONE			
		BARGO CLAYSTONE				
TONGARRA COAL		TONGARRA COAL				
		WILTON FORMATION	Wanganderry Sandstone Member		WILTON FORMATION	
TONGARRA COAL						
MARANGAROO CONGLOMERATE		Woonona Coal Member	THIRROUL SANDSTONE			
		THIRROUL SANDSTONE				
CUMBERLAND SUBGROUP	PHEASANTS NEST FORMATION		ERINS VALE FORMATION		CUMBERLAND SUBGROUP	
			Figtree Coal Member			
CUMBERLAND SUBGROUP	PHEASANTS NEST FORMATION		Unanderra Coal Member	PHEASANTS NEST FORMATION		
			Berkeley Latite Member			
			Minnamurra Latite Member			
			Calderwood Latite Member			
			Five Islands Latite Member			

LEGEND

DO NOT SCALE THIS DRAWING - USE FIGURED DIMENSIONS ONLY. VERIFY ALL DIMENSIONS ON SITE.

CLIENT

PROJECT

NAME
ILLAWARRA COAL - COMPETENT PERSONS REPORT

DRAWING
GENERAL STRATIGRAPHY OF THE ILLAWARRA COAL MEASURES

FIGURE No. 4.2	PROJECT No. ADV-SY-04120	Date March 2015
-------------------	-----------------------------	--------------------

Not to Scale	Ply Parting	Description	Previous		Current
			Area 3A	Area 3B	
	WW01		Not Sampled for Coal Quality Roof Ash and Rd only		
	WWSB	Sandstone Band			
	WW02U				
	WWIB	Ironstone Band			
	WW02L		WON_WW2L		
	WW2M	2nd Machine Band		WON_05_2M	
	WW03				
	WWWR	Working Roof			
	WW04				
	WWWP	Wonga Parting			
	WW05				
	WWCB	Clay Band			
	WW06		WON_11_2M	WON_11_CB	WON_11_2M
	WTDB	Double Bands			
	WW07				
	WBDB				
	WW08				
	WWHB	Holing band			
	WW09				
	WWBB	Bottom Band			
	WW10				
	WWFB	Floor Band			
	WW11				
	WWAB	Avon band			WON_12_AB
	WW12				
	KBSS	Kembla Sandstone	Floor Ash and RD only		

Reproduced from BHPB Competent Persons Report for Illawarra Coal as at 30 June 2014

LEGEND

CLIENT	PROJECT		
 Illawarra Coal	NAME	ILLAWARRA COAL - COMPETENT PERSONS REPORT	
	DRAWING	WONGAWILLI SEAM SUBDIVISION	
FIGURE No.	PROJECT No.	Date	
4,3	ADV-SY-04120	March 2015	

4.1.3 Faulting

Faulting has been identified across the BSO and Dendrobium Operation. The faults have been identified by 3D seismic, 2D seismic, underground mapping, underground drilling, de-gassing intra-seam holes and, to a lesser extent, interpreted from floor contours generated from drill-hole data. The faults are predominately extension normal faults, although low angle thrust faults have also been identified (such as Maingate 12 at Dendrobium). The location and orientation of the known and interpreted faults at the BSO and Dendrobium Operation are shown in Figure 4-4 and Figure 4-5.

Faulting affects the BSO area more significantly than at the Dendrobium Operation. Fifty-one faults have been interpreted at the BSO area to a level of confidence that allows them to be incorporated in the geological model. The throw on the Appin faults average approximately 20 m, although the maximum throw is 90 m; approximately 13 faults have throws of greater than 5 m. As the average thickness of the Bulli Seam is less than 2.7 m, a throw of more than 2 to 3 m can adversely impact the potential for eventual economic extraction. This was demonstrated at West Cliff where LW 22 to 24 were constrained due to faulting. The Appin mine plan has been laid out to avoid the significant faulting identified by exploration to date.

At the Dendrobium Operation only four faults are incorporated into the Dendrobium Operation geological model. Of these, only two are located within the current mine plan:

- Elouera Fault – identified in the old Elouera underground workings, affecting the southern boundary of the Project area, displacement of up to 20 m.
- WW1 Fault – Small displacement fault (less than 5 m) identified in the northwest mains workings, between Areas 2 and 3. There are a number of features that have been interpreted as probably faulting but to a lesser degree of confidence.

As well as the four modelled faults, there are a number of interpreted fault structures for the Dendrobium Operation, shown in Figure 4-5. Most of the predicted structures are understood to be minor and not expected to affect mining operation due to their limited throw.

Faulting can have a significant impact on the development of a longwall operation. RPM considers Illawarra Coal's approach to the identification of faults to be suitable to minimise the impacts on the mine plan.

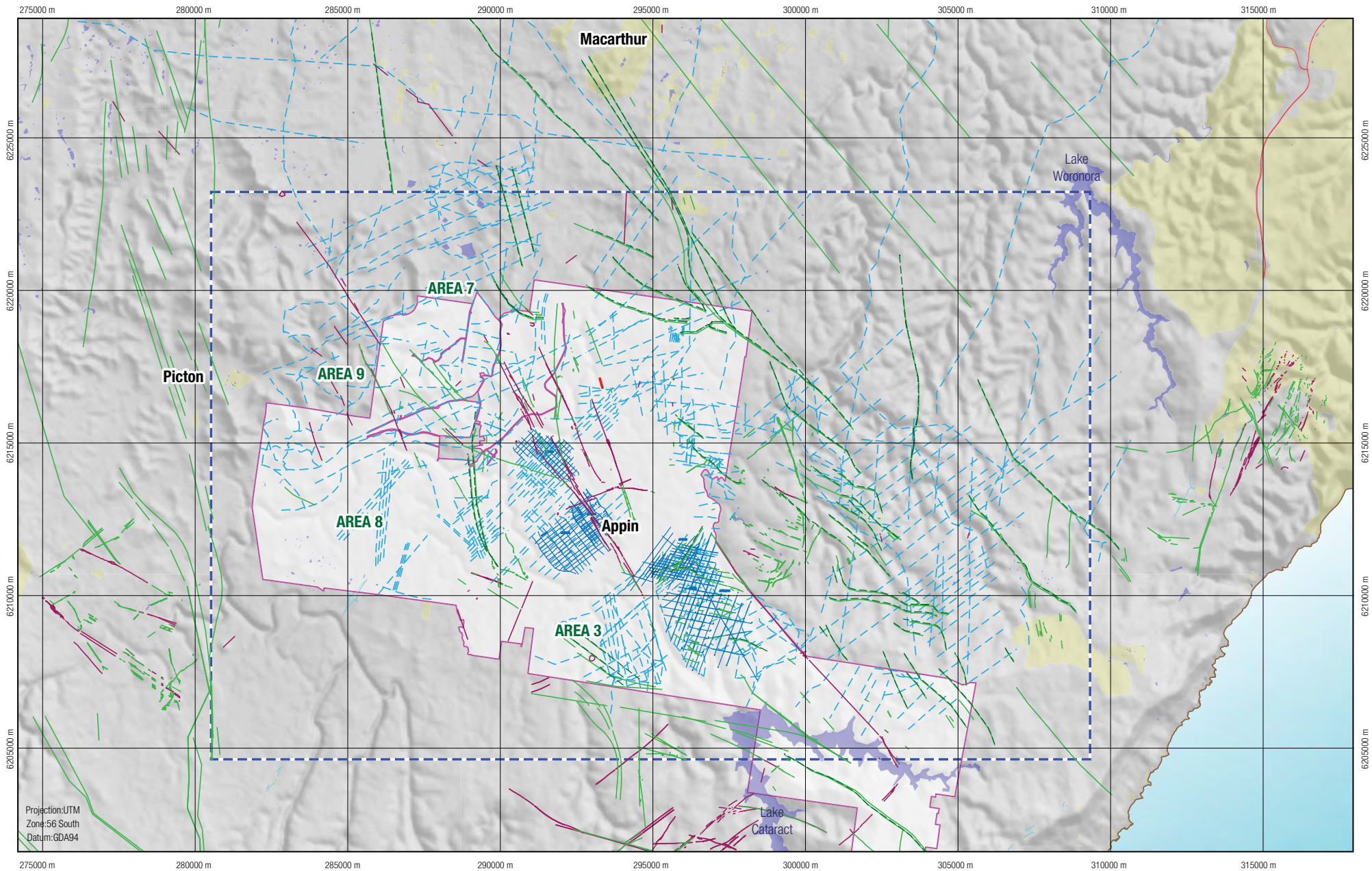

Projection: UTM
 Zone: 56 South
 Datum: GDA94

LEGEND

- CCL767 boundary
- Model Limit
- 2D Seismic Lines
- 3D Seismic Lines
- Modelled Faults
- Interpreted Faults
- Interpreted Dykes



CLIENT

PROJECT

NAME: **ILLAWARRA COAL - COMPETENT PERSONS REPORT**

DRAWING: **KNOWN AND INTERPRETED STRUCTURAL FEATURES - BSO**

FIGURE No. 4.4	PROJECT No. ADV-SY-04120	Date March 2015
-------------------	-----------------------------	--------------------

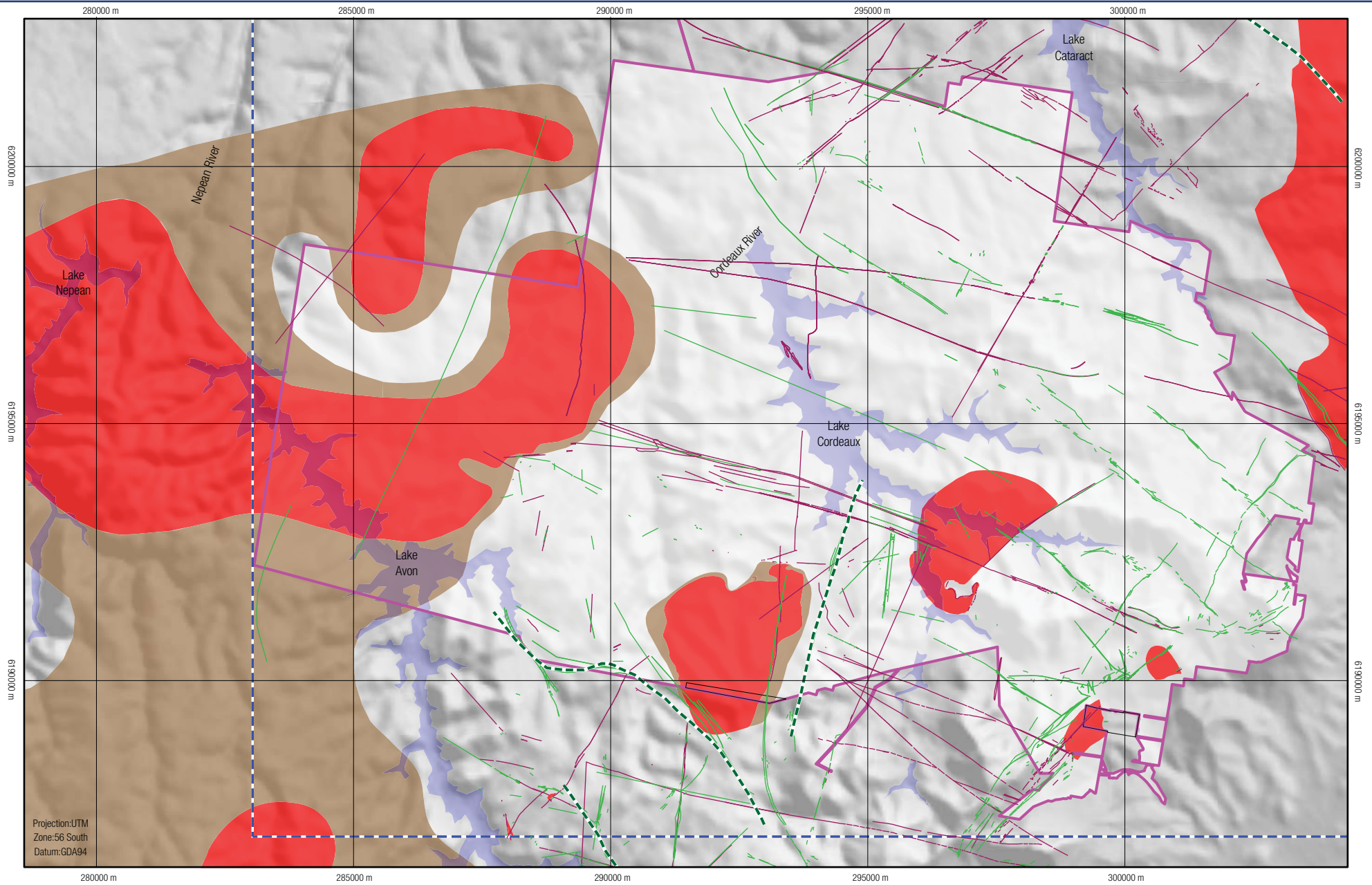

LEGEND					
	CCL768 boundary		3D Seismic Lines		Interpreted Dykes
	Model Limit		Modelled Faults		Sill affected WW Working Section
	2D Seismic Lines		Interpreted Faults		Sill affected WW seam above Working Section



CLIENT

resourcing the future
 Illawarra Coal

PROJECT

NAME
ILLAWARRA COAL - COMPETENT PERSONS REPORT

DRAWING
 KNOWN AND INTERPRETED STRUCTURAL FEATURES - DENDROBIUM

FIGURE No. 4.5	PROJECT No. ADV-SY-04120	Date March 2015
-------------------	-----------------------------	--------------------

4.1.4 Intrusions

Igneous intrusions are present at both the BSO and Dendrobium Operation.

The BSO has igneous dykes varying from near vertical and thin (less than 0.3 m), which are boggy and soft and easy to mine, to more significant dykes of 4 to 5 m in width which are very hard (up to UCS of 270 MPa) and more difficult to mine. Through geological studies and operating experience, the igneous dykes are understood and have been observed to have narrow contact margins. Hard and wide dykes are being intercepted in the current mining area.

At the Dendrobium Operation Tertiary igneous intrusions, in the form of sills and dykes, post-date the sedimentary strata in the area which hosts the coal. Sills and dykes have been identified through a combination of surface mapping, vertical drilling, in seam drilling, aeromagnetic survey and from mining.

Extensive igneous sills have been identified in the Wongawilli Seam and have had significant impacts on the extent of economic coal at the Dendrobium Operation. Sills that affect the Wongawilli Seam have been interpreted and are shown on Figure 4-5.

Additionally, there is a swarm of dykes known as the Dendrobium Dyke Zone located directly north of Dendrobium Area 2. The Dendrobium Dyke Zone currently defines the northern limit of the Dendrobium Mine design for Areas 2 and 3.

The position and extent of known and interpreted dykes for the BSO and Dendrobium Operation are shown on Figure 4-4 and Figure 4-5 respectively. RPM considers the intrusions are reasonably well understood in the Project areas and have been correctly incorporated into the geological model.

4.2 Exploration

4.2.1 Drilling

The Project has a long history of exploration with a range of exploration activities and techniques having been applied at the Project. Since 2006, surface drilling has been completed predominately using a HQ size core, however prior to 2006 various sizes were utilised. Similarly, the standard and format of the geological data collection has varied considerably with all historic data having to be converted from imperial to metric units.

Exploration drilling has generally been from the surface using standard exploration drilling practices. Some angled drill-holes and in-seam drilling have also been completed.

Access to drilling sites is difficult due to the nature of the terrain and environment. As such, drilling activities can be relatively expensive and the locations of drill-holes may be limited.

Since 2006, the exploration procedures have been standardised. When drilling from the surface the following data is collected:

- Lithology (including core photos);
- Geotechnical data (including defects, stress direction and magnitude, point load tests and geo-mechanical tests);
- Seam gas testing (composition and content) and location of strata gas zones;
- UV analysis (for hydrocarbon detection);
- Down-hole geophysics (density, gamma, neutron, resistivity, sonic, verticality, full wave form sonic, acoustic scanner and calliper);
- Coal quality (pre-treatment, washability testing, and proximate and composite analysis) for the following:

- At the BSO the primary target of exploration is the Bulli Seam and is the only seam to be sampled and modelled.
- At the Dendrobium Operation the Wongawilli Seam is the primary target of exploration, and is the only seam sampled.
- Coal and strata permeability; and,
- Hydrogeological information (standing water level , reservoir pressures, water quality) with piezometers having been inserted in every hole drilled since 2006.

RPM has reviewed the procedures used in the current and recent exploration programmes and considers that they are suitable for the Project.

The exploration budget forecast for the next five years consists of approximately USD 6 M for FY2015 and approximately USD 12 Mpa for FY2016 – FY2019.

Illawarra Coal seek to maintain a Measured Resource covering the areas of current mining activity and the areas planned to be mined over the next five years. RPM has reviewed Illawarra Coal's exploration budget and considers it to be appropriate for the expected exploration drilling required for further Resource definition. Illawarra Coal's exploration budget includes seismic surveys which are conducted using in-house equipment and personnel and is therefore cost effective.

4.2.2 Geophysical Surveys

Structural continuity of a coal seam is required for longwall coal mining operations. The information from seismic surveys is critical to gaining an understanding of the local geology and expected mining conditions.

A significant amount of 2D and 3D seismic surveys have been completed over the Illawarra Coal areas as shown on Figure 4-4 and Figure 4-5. Interpretation of the seismic data provides definition on the continuity and structure of the stratigraphic sequence including identification of faulting. Illawarra Coal has its own geophysical survey equipment which has been upgraded over time to meet progressive industry standards.

In areas of easy access and relatively cleared land 3D seismic surveys have been completed. Where there is less access, 2D seismic data has been collected. Both data sets are reviewed and validated prior to being used as reference material in the geological model. RPM has reviewed the methodology of interpreting and utilising seismic data and considers that the data has been used correctly. As a result, Illawarra Coal has a good understanding of the geological structure in the areas refined by seismic data.

Aeromagnetic surveys have also been undertaken principally to identify igneous intrusions. A total of seven aeromagnetic surveys have been completed over the BSO and Dendrobium Operation areas. The surveys have identified and helped define igneous intrusions and structures that may influence future mining such as the Dendrobium Nepheline Syenite.

4.2.3 Mapping

Mapping is completed by Illawarra Coal geologists on a regular basis and is sometimes incorporated with channel sampling for bulk density coal quality testing. Within the mapping process, joint orientations are measured together with any throws on mapped faults. Some areas have also incorporated coal seam floor data from survey, which is used in areas of uncertainty.

4.2.4 Topography

The digital terrain model (DTM) used in the structural model was derived from an Optech Airborne Survey flown in December 2005. Nominal absolute accuracy of the DTM dataset is +/-150mm. The DTM is considered appropriate for the Project.

4.3 Geological Data

RPM has reviewed Illawarra Coal's geological data collection and management processes and considers them suitable for the Project.

4.3.1 Geological Data Storage

Drilling data is stored in a Micromine SQL Server based GBIS database. The GBIS database was specifically developed for geological data and is currently in use across the coal industry. RPM considers GBIS to be a suitable database for the management of drill-hole geological data.

Other geological information such as seismic data and mapping data from the workings is stored on an internal Illawarra Coal data sharing intranet. The Intranet also stores broader project information such as survey, geotechnical, environmental and mining data. The information on the Intranet is available to all Illawarra Coal staff. RPM considers this to be a well-established and robust data management system.

4.3.2 Drill-hole Collar Survey

RPM considers the current practices for surveying drill-hole collars to be appropriate, however notes that historical survey methods applied at the Project have not always been documented. Differential GPS is used by Illawarra Coal to survey the drill-hole collar location and record the co-ordinates in a borehole database. Instruments are tested annually and their accuracy is assessed on a weekly basis by comparing to a known location.

Historical drill-hole survey co-ordinates were previously transcribed from the Integrated Survey Grid ("ISG") to the Map Grid of Australia ("MGA") and have been reviewed and verified by Illawarra Coal's Competent Persons. In 2010, the drill-hole collar information was audited by Minserve.

Drill-hole collars are sorted based on their reliability in the drill-hole database. Illawarra Coal only uses drill-holes where the collar information in GBIS has been verified.

RPM compared the drill-hole collar elevations against the topographic surface used in the geological model. This showed that the elevation of a significant number of drill-hole collars did not match the topographic surface. This was due to a combination of a relatively coarse 100 m x 100 m grid applied to the topographic surface and steep site topography. The identified discrepancy between the topographic model and the true topography is not considered material to the geological model.

RPM compared the survey certificates for a small selection of random drill-holes against the collar co-ordinates used in the geological model. These were found to be consistent and within the acceptable range to be included in a Coal Resource estimate.

4.3.3 Lithology

Since 2006, Illawarra Coal has followed a data collection procedure for logging and collating lithological information which RPM has reviewed and considers appropriate and suitable for the coal deposits of the Project. The procedure includes the logging of all holes in detail and recording of information in a temporary database. Following geophysical corrections, photographs and validation by key Illawarra Coal staff, the information is added to a permanent GBIS database.

Prior to 2006, lithological records were validated by the relevant Competent Person for Coal Resources prior to estimation and reporting. The logs were only used once they were validated.

RPM reviewed a small selection of random lithological logs within the Project area. The lithological information recorded in the logs was considered appropriate.

4.3.4 Downhole Geophysics

Geophysical surveys are used to confirm the geological interpretation from geological logging and to undertake depth corrections on the geological log. Geophysical surveys assist greatly in the accurate definition of the coal seams and also assist in identifying geotechnical and or geological hazards.

Whilst nearly all drill-holes in the Project areas have a basic suite of geophysical surveys, more comprehensive geophysical surveys have been conducted on exploration completed since 2006.

Whilst RPM did not review any down-hole survey information, based on the type of geophysical surveys conducted and the documented procedures for collecting and assessing this information, RPM considers the geophysical surveys undertaken to be sufficient for the Project.

4.3.5 Seam Interpretation

Seam interpretation is considered to be relatively simple within the Project area based on the consistent geology and the extensive mining and exploration history in the area.

An extensive knowledge base has been developed over time and the stratigraphy is well understood. The geological models are mature models and the seam interpretation is well documented. Based on the documented Illawarra Coal processes and the data which has been collected, RPM considers that the seam interpretation and correlations are an accurate reflection of the in-situ geology.

4.3.6 Coal Quality and Washability Data

Sampling

Coal Quality and Washability data is derived from drill core samples and channel samples from the underground workings. The procedure for sampling from drill core and channel samples was reviewed by RPM and considered to be appropriate.

At the BSO, the Bulli Seam is usually sampled as one unit, while at the Dendrobium Operation the Wongawilli Seam is currently sampled in three identified working sections as shown Figure 4-3.

Coal Quality Testing

The current testing program for the Wongawilli Seam from the Dendrobium Operation includes Raw Coal testing which includes Ash, Relative Density (RD), and Moisture Holding Capacity (MHC). This is followed by detailed pre-treatment, float sink testing and then the preparation of two clean coal composites; a coking coal composite and an energy coal composite.

The coking coal composite is prepared to an Ash of 8.9% (ad) from the Bulli Seam and 9.7% (ad) from the Wongawilli Seam, using appropriate proportions of the different size and float fractions. The energy coal composite is prepared to a target Ash of 17% (ad) from the Bulli Seam and 23% (ad) from the Wongawilli Seam, comprising of sinks fractions remaining after the preparation of the coking coal composite.

Both composites are subjected to Proximate, Sulphur, Phosphorous, Ash Analysis, and Crucible Swell Number (CSN). The coking coal composite is also subjected to Fluidity, Dilation, Carbon Dioxide, Carbonate Carbon, Mineral Matter and Ultimate Analysis. The energy coal composite includes testing for Gross Calorific Value. Petrographic analysis including Reflectance and Maceral Analysis is also completed on both composites.

The current testing program for the Bulli Seam from the BSO includes the following (after it has returned from gas testing at Illawarra Coal in-house laboratory):

The sample is prepared, dried mass recorded, drop shatter tests, dry tumble, wet tumble and float sink testing.

- Clean Coal Coking composite:
 - Proximate, Ultimates, Coking indices, Ash analyses, Petrography.
- Clean Coal Energy composite:
 - Proximate, Ultimates, Petrography, Ash fusion.
- Raw composite; Proximate analyses, Ash, RD and MHC.
 - MHC has not historically been analysed.
 - Where absent defaults are used for MHC.

- Where absent a calculation based on ash is used for RD.

RPM found that historical coal quality testing has not necessarily replicated the current testing procedure. However, as coking coal recovery is the most critical quality factor in determining mining economics, if this is able to be determined from the historical quality data, then the data can be used to support higher confidence resource categories such as Indicated and Measured Resources.

The current sampling and testing program is focussed on defining the existing product specification from the current planned working sections. There is limited focus on defining the in situ qualities on a ply by ply basis therefore there is limited ability to review the potential qualities of different working sections of product specifications.

Coal quality testing is currently completed at the NATA registered SGS Newcastle Laboratory. Work performed by SGS laboratories is conducted under the terms of a sub-contractor agreement. This agreement stipulates required sample control and storage procedures, analytical procedures and standards, participation in NATA, internal SGS and BHP Billiton round robin check testing and document control.

SGS Newcastle NATA registration was confirmed by RPM and evidence of check testing was observed. All analytical procedures are conducted to appropriate Australian Standards. Prior to using SGS, testing was completed at Bureau Veritas Wollongong, a similarly accredited laboratory.

The coal quality data used in the quality model and subsequent Coal Resource estimate was reviewed. The data was reviewed by completing basic checks using histograms, sensibility checks (i.e. back calculating rejects ash values) and using histograms between key coal parameters to investigate if the dataset is robust. In general, no material issues were identified. There was a minor amount of anomalous values observed, however for a dataset of this size this is considered acceptable.

A small selection of original laboratory reports were cross referenced against the data values provided in the quality table. No material differences were identified.

4.4 Geotechnical and Hydrogeological Conditions

4.4.1 Geotechnical Setting

Geotechnical information is collected from exploration drill-holes. The drill-hole information collected includes rock strength, lithological properties, rock mass structure and other properties. Drill-core samples of the lithological units are collected and submitted to laboratory testing including uniaxial compressive strength, tri-axial, sonic velocity and slake durability testing. Down-hole geophysical surveys using Acoustic Televiewer and Sonic Velocity are also utilised to gather geotechnical information. The same information is not available for earlier drill-holes due to varying collection methods over time. Geotechnical information from drill-holes, existing mine workings and ongoing geotechnical monitoring is collected and stored in the GBIS database.

The systematic collection of geotechnical data allows for the geotechnical characterisation of the each of the identified rock mass units. The rock mass units are generally understood to be fairly consistent over the Project area. RPM reviewed the level of data collected from exploration drill-holes and consider the level of data collected appropriate.

There is now extensive experience of mining at the Project and more broadly in the Southern Coalfields, such that empirical relationships between rock characterisation and geotechnical performance can be utilised to support the extraction of coal.

The overall approach to managing geotechnical hazards at BSO and Dendrobium Operation is documented in the Major Hazard Management Plan for Strata Failure (MPMP-SF) developed for the separate operations. This includes specified intervals for geotechnical inspections.

Based on the understanding developed from the information provided, the approach to gathering and managing geotechnical data is considered appropriate.

Geotechnical conditions have been described in reports prepared by consultants Palaris and Strata Engineering. Key observations for the BSO are summarised below:

- The operations are some of the deepest operating underground coal mines in Australia, as such there may be issues associated from stress and loading;
- Periodic loading may occur on the longwall face due to the thickness of the Wombarra Claystone. This issue has been address in the comprehensive Appin Area 9 Project Definition Phase Report (2012) and a hazard plan has been implemented. Illawarra Coal personnel interviewed by RPM advised that this is not considered a safety or production issue; and,
- There is a risk of de-gassing of the Balgownie Seam into the Bulli goaf when the Loddon Sandstone, which is the inter-burden between the Balgownie and Bulli Seams becomes less than five metres thick. This may be relevant near Longwall 905-906 where the inter-burden thins. This is currently under review by Illawarra Coal.

The Bulli Seam floor is occasionally underlain by a thin claystone band. The intermittent nature of the claystone means that development operations must be prepared to respond to changing conditions on a short term basis. This may temporarily impact on development rate and cost in certain areas.

Key observations have been made in Illawarra Coal's 2014 Competent Persons' Report and Geology & Mineral Resources Report for Dendrobium (Area 3B) regarding geotechnical conditions, these include:

- Thin areas of Kembla Sandstone which comprises the floor of the Wongawilli Seam, may cause increased horizontal stress in the immediate roof leading to less stable roof conditions. This has the potential to lead to failure of the floor unit under horizontal stress on development or under longwall abutment loading, resulting in floor heave and less stable pillars and ribs;
- The main working section (up to the Second Machine Band) typically results in good roof conditions due to the presence of the stable WW2L unit in the immediate roof. If the WW2L unit is included in the working section, this results in the thinly bedded Ironstone Band Unit in the immediate roof, which is susceptible to failure whenever there is deterioration in ground conditions. The proximity of the Ironstone Band to the immediate roof is assessed to be critical to the development of longwall roof stability. Experience at Dendrobium indicates that the critical thickness between the roof and base of the Ironstone Band (i.e. WW2L ply) is around 0.3 m;
- The effect of thick silling in the roof of the Wongawilli Seam on periodic weighting is highly variable and difficult to predict. The western ends of panels in Area 3B will need to consider the potential for periodic weighting; and,
- Future mining at Dendrobium is generally at greater depths and will be subject to increasing vertical and horizontal stresses.

4.4.2 Hydrogeological Setting

Piezometers are used to measure groundwater pressures and are routinely placed in exploration drill-holes completed by Illawarra Coal. One or more piezometers have been installed in the majority of exploration drill-holes completed in recent (post 2006) exploration programs. In some drill-holes, multiple piezometers are installed in vertical arrays to identify and monitor separate aquifers within the stratigraphic sequence.

The piezometers are monitored live on the Illawarra Coal Intranet and data records from 2006 can be readily accessed by Illawarra Coal staff. The data is used to model piezometric surfaces for the separate aquifers within the Project area over time, such that the hydrogeological issues associated with the mining operations can be assessed.

The recognised aquifers in the Illawarra Project which are monitored are the Hawkesbury Sandstone, sandstones of the Narrabeen Group, as well as the Coal seams.

Key hydrogeological features of the Project area include:

- Coal seams are the principal aquifers at depth;
- Hawkesbury Sandstone and sandstones of the Narrabeen Group are the main aquifers near surface, producing low yield good quality water;
- Water flowing through the Wianamatta Group is retarded by the Ashfield Shale and Mittagong Formation;
- The Bald Hill Claystone is an important stratigraphic element within West Cliff and Appin as it can form an aquatard from the inflow of overlying sub-surface water. It is a thick unit that is unlikely to crack when mined underneath; and,
- The aquifers of the Narrabeen Group are retarded by the Wombarra Claystone. The claystone is likely to crack when undermined, but the waters flowing through the Narrabeen Group are considered small and of poor water quality.

Illawarra Coal has a high level of knowledge regarding hydrogeological features at the BSO and Dendrobium Operation areas.

5 Geological Models and JORC Coal Resource Review

The “Competent Person Report for Illawarra Coal as at 30 June 2014 including Resources and Reverses” (“2014 Resource and Reserve Report”) was prepared in June 2014 by Illawarra Coal personnel. The 2014 Resource and Reserve Report included Coal Resource and Coal Reserve estimates for the BSO and Dendrobium Operation. The below review is based primarily on this document as well and the supporting digital data.

5.1 Geological Models

Geological models have been developed by Illawarra Coal for the BSO and the Dendrobium Operation using Ventyx MineScape 5.4 software. The geological models are based on the extensive exploration data and observations from the existing operations and form the basis of the geological understanding of the Project areas. The models are routinely updated by site personnel and are validated using the Illawarra Coal Modelling and Model Variation Procedure. RPM reviewed this internal procedure and considers it to be appropriate for the Project.

5.1.1 Structural Model Review

The BSO geological model covers an area of approximately 53,000 ha (Figure 2-2) and is interpreted based on data from approximately 748 drill-holes from the BSO and Dendrobium Operation areas. The geological model for the Dendrobium Operation covers an area of approximately 44,200 ha (Figure 2-3) based on data from 313 drill-holes, however only 248 drill-holes of the 313 drill-holes are located with the modelled area.

In addition to surface drill-holes, the structural models for each operation incorporate the following geological features:

- Faulting;
- Silling;
- Seam thickness mapping data;
- Depth converted seismic data;
- In-seam drilling data (RL of roof and floor touches); and,
- Medium Radius Drilling data (RL of roof and floor touches).

The structure data is gridded using a 100 m x 100 m grid specification covering the respective Project areas to create grid surfaces of the roof and floor of each of the stratigraphic units identified. A Finite Element Modelling (“FEM”) interpolator is used to build the surfaces.

The structural model was reviewed by RPM by checking the inputs and methodologies of the geological model and interrogating the resultant interpretations using contours and cross sections to identify any anomalous values. The input data was also compared with the resultant structural grids to ensure that the drill-hole data was being honoured.

Representative cross section through the BSO area and the Dendrobium Operation areas are shown on Figure 5-1 and Figure 5-2 respectively.

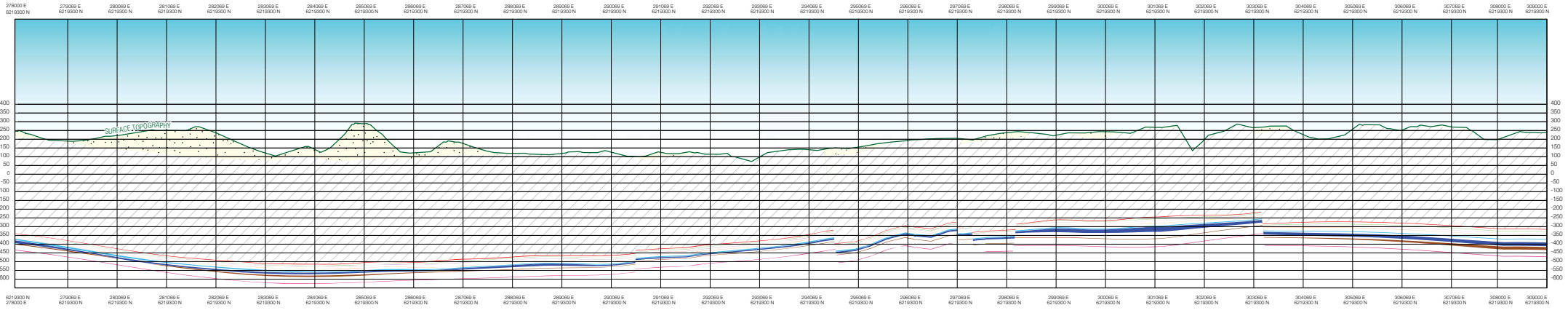

SECTION A-A'

This Section is displayed using a Vertical Exaggeration of 5:1

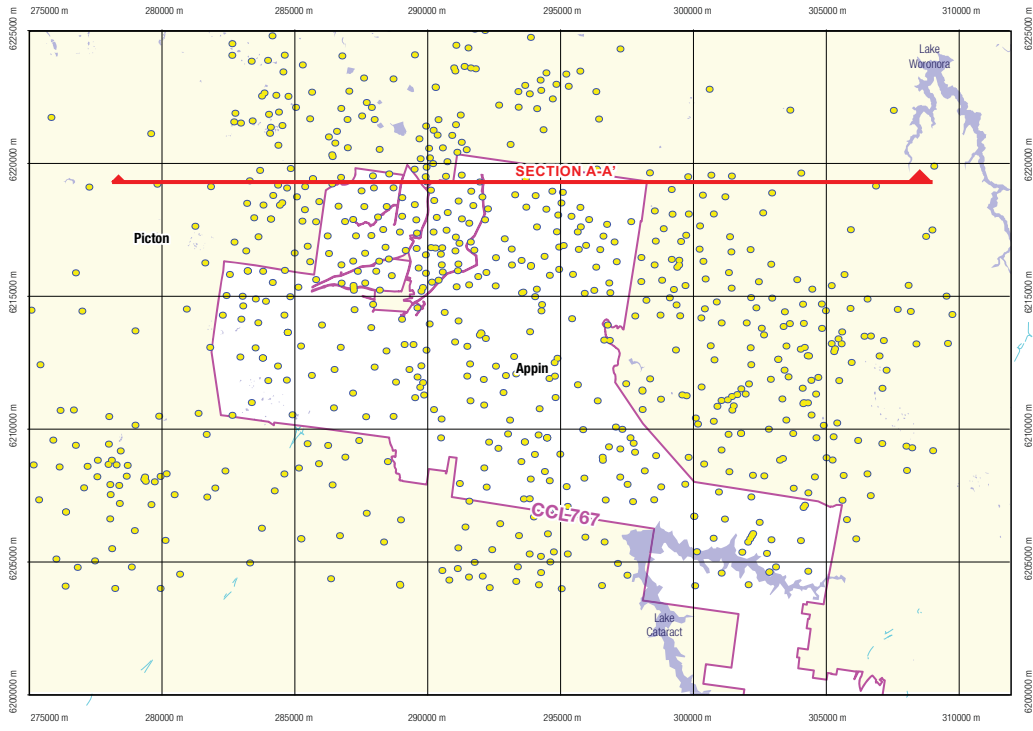

LEGEND					
	Hawkesbury Sandstone		Bulli Coal		Wongawilli Coal
	Narrabeen Group		Balgownie Coal		American Creek Seam
			Cape Horn Coal		Tongarra Coal Seam
			Hargrave Coal		

CLIENT resourcing the future Illawarra Coal	PROJECT NAME ILLAWARRA COAL - COMPETENT PERSONS REPORT	
	DRAWING STRUCTURAL CROSS SECTION - BSO	
FIGURE No. 5.1	PROJECT No. ADV-SY-04120	Date March 2015

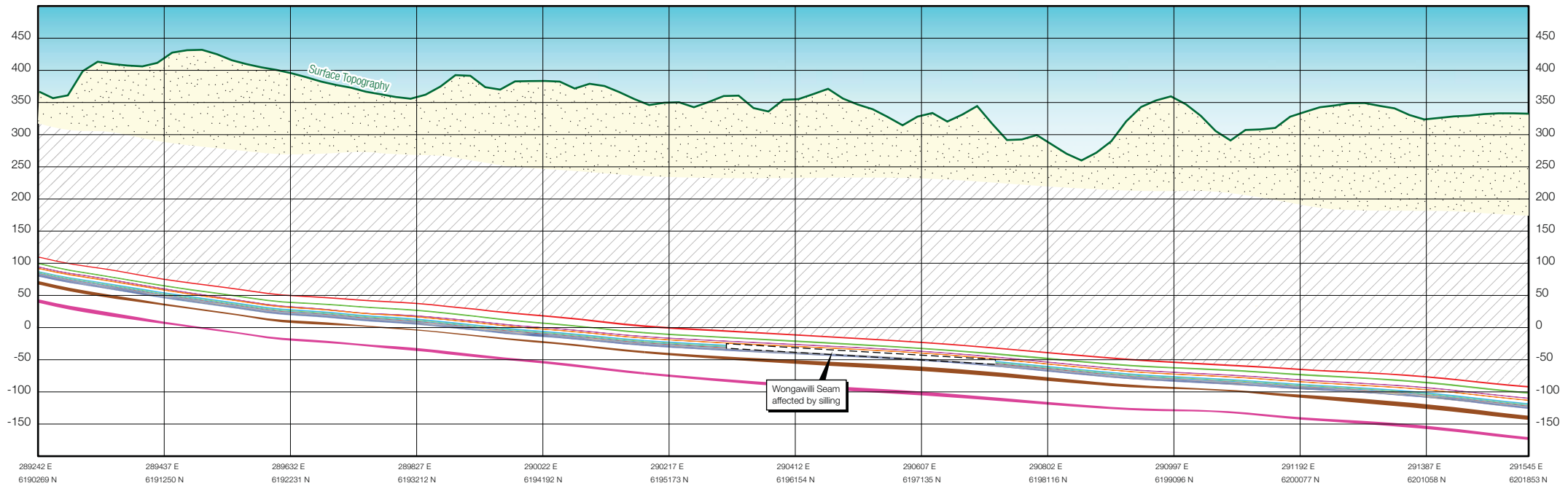

SECTION A-A'

This Section is displayed using a Vertical Exaggeration of 5:1

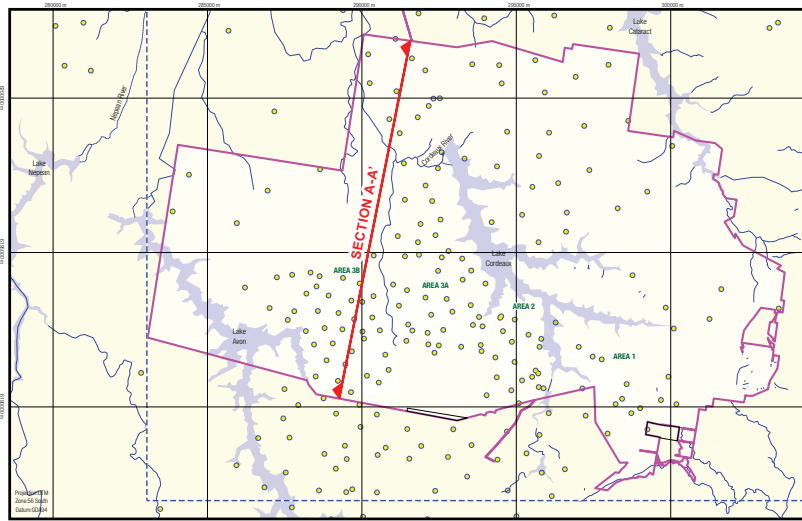

LEGEND

- | | | | | | |
|--|----------------------|--|----------------|--|---------------------|
| | Hawkesbury Sandstone | | Bulli Coal | | Wongawilli Coal |
| | Narrabeen Group | | Balgownie Coal | | American Creek Seam |
| | | | Cape Horn Coal | | Tongarra Coal Seam |
| | | | Hargrave Coal | | |



CLIENT



PROJECT

NAME ILLAWARRA COAL - COMPETENT PERSONS REPORT		
DRAWING STRUCTURAL CROSS SECTION - DENDROBIUM		
FIGURE No. 5.2	PROJECT No. ADV-SY-04120	Date March 2015

5.1.2 Structural Model Conclusions

The full sequence of sedimentary units identified in the respective Project areas are modelled enabling a suitable geological understanding of the mining areas of the Project to be developed to a suitable accuracy for inclusion in resource estimate. In addition RPM considers that the geological features which form the basis for the geological interpretation are appropriately taken into account in the structural model.

The resultant structural model is not used in mine planning or resource estimation directly and is only used as the basis of the geological understanding. The coal volumes reported from the geological models, which form the basis for Project's mine planning, are based on the gridded coal thicknesses from the quality tables recorded for each drill-hole.

While RPM concludes that there is no material difference between the coal volumes of the geological models and the thickness grid used for mine planning, the use of an independently created thickness grid is considered not to be as robust as utilising geological modelling software, such as MineScape, to create a structural model.

5.1.3 Coal Quality Model Review

The Coal Quality models were constructed from sample data which was stored in GBIS and exported into MineScape software as a table file. The Coal Quality data from the table file was gridded using the same 100 m by 100 m grid specification as the structural model.

The Coal Qualities modelled for the Bulli Seam at BSO and the three main working sections identified in the Wongawilli Seam at the Dendrobium Operation are shown in Table 5-1.

Table 5-1 - Modelled Coal Qualities

Sample Type	Quality	Dendrobium Operation	BSO
Raw	Raw Ash	Yes	Yes
Coking Fraction Composite	SG insitu	Yes	Yes
	Coking Yield	Yes	Yes
	Coking Ash	Yes	Yes
	Volatile Matter	Yes	Yes
	Phosphorous	Yes	Yes
	Crucible Swell Number	Yes	Yes
	Vitrinite %	Yes	Yes
	Vitrinite Reflectance	Yes	Yes
	Sulphur	Yes	Yes
	Fluidity	Yes	Yes
	Ash Analysis	Yes	Yes
Energy Fraction Composite	Energy Yield	Yes	Yes
	Energy Ash	Yes	Yes
	Gross Calorific Value	Yes	Yes
	Volatile Matter	Yes	Yes
	Sulphur	Yes	Yes
	Phosphorous	Yes	Yes
	Vitrinite %.	Yes	Yes
Jig Coal Composite	AFT	No	Yes
	Jig Yield	No	Yes
	Jig Ash	No	Yes

RPM reviewed the Coal Quality surfaces for each of the seams and working sections and identified no significant anomalies indicative of modelling error. In addition the quality model was audited by Minserve in 2010 with no erroneous outcomes. A different interpolator was suggested by Minserve in their 2010 audit, which Illawarra Coal has reviewed but considered unnecessary and documented accordingly (Modelling Interpolator Comparison (2013)).

The geological model has undergone extensive internal review by Illawarra Coal (Model Validation Procedure (2009) and by Minserve (2010). RPM has reviewed both documents and consider that the internal and external review process to be appropriate.

The Raw Ash and Coking Product Yield for the Bulli Seam at BSO and the Wongawilli Seam main working sections at the Dendrobium Operation are shown in Figure 5-3 and Figure 5-4 respectively.

5.1.4 Coal Quality Model Conclusions

RPM considers the Coal Quality model to be a reasonable representation of the geological data. The quality data for Illawarra Coal's geological models resides within the geological database (GBIS). Quality data is selected by a reliability code and an SQL is performed to export the data. Data is composited against lithology to create a data file. This file is subsequently imported into MineScape to create a table, which is then gridded.

Whilst this process differs from how coal quality models are typically generated in MineScape, RPM considers that the coal qualities in the geological model are a reasonable representation of the geological data.

Reconciliation between actual mining data and modelled values occurs on a monthly basis and any differences are assessed and actioned if required. As per Illawarra Coal's 2014 Competent Person Report, in the previous five years, there have been no instances where identified variations have required alterations to the modelling methodology. This indicates that the geological modelling methodology has produced robust results in the area of mining over that period.

5.2 JORC Coal Resource Review

The Competent Person for the Coal Resources completed by Illawarra Coal was Mr Hugo Kaag. RPM considers that the Competent Person meets the competence criteria as described in the JORC Code.

5.2.1 Methodology

The general method applied for Illawarra Coal's Coal Resource estimation was:

- Interpreting and validating exploration data and inputting this data into a geological database package (Micromine GBIS);
- Relevant geological information including seam thickness and raw and product seam qualities, is then exported from the database using selection criteria and imported into the Ventyx MineScape Version 5.4 geological modelling software;
- The data is then gridded in MineScape to create a 2-dimensional surface across the Project area;
- Points of observation are defined from drill-hole intersections and underground observations and are classified to support different resource categorisation. Resource categorisation areas are based upon distances from points of observation along with other categorisation criteria such as the presence of structural controls supported by seismic surveys;
- Resource constraints were used to limit the resource categorisation area. These constraints included an assessment of the potential for economic extraction, and geological features such as igneous sills;
- Resource areas were then estimated by interrogating the seam thickness and quality grids within the respective resource categorisation areas; and,
- Coal Resources were reported in an 2014 Competent Person Report which reports Coal Resources and Coal Reserves as at June 2014 in accordance with the JORC code.

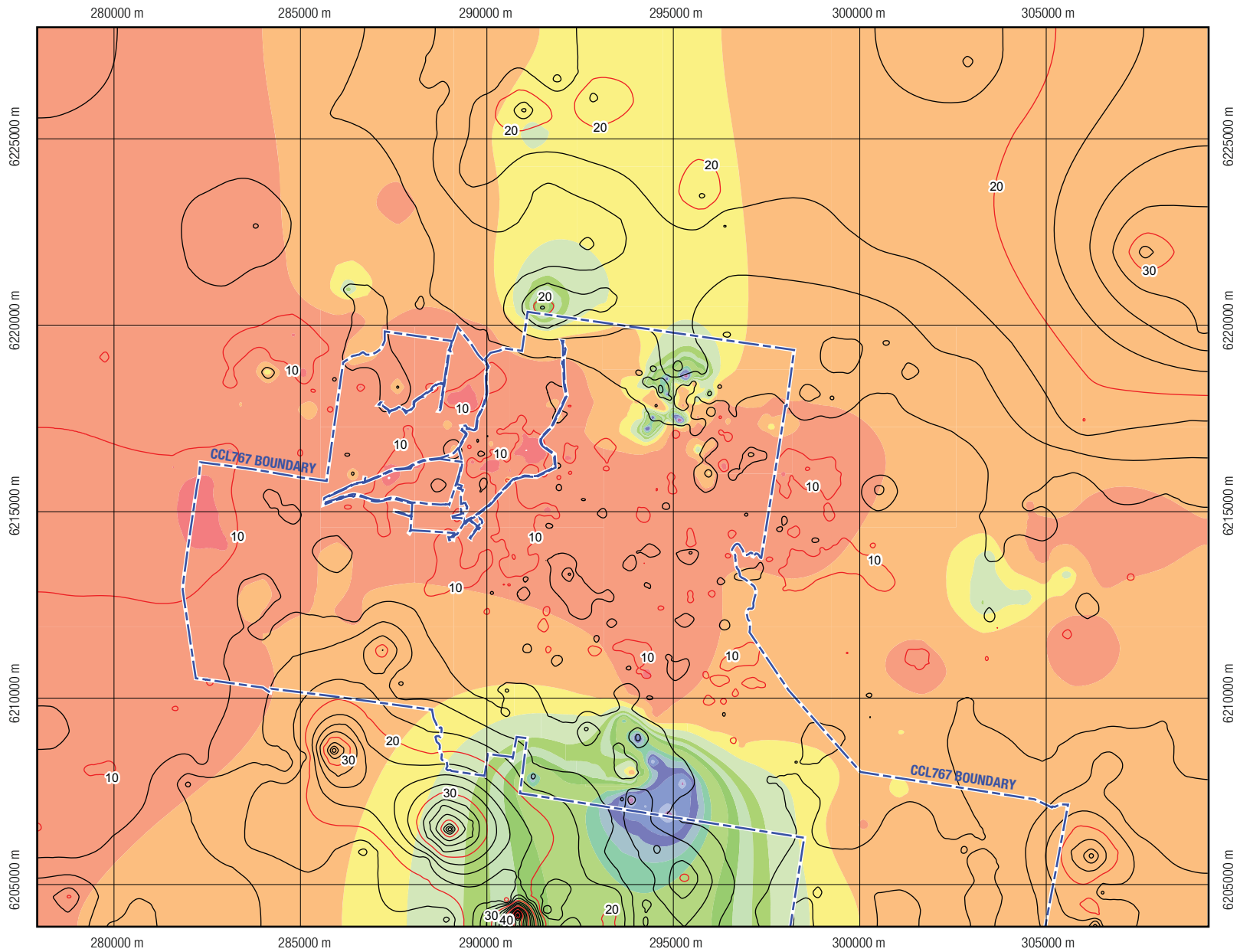

LEGEND - Coke Yield (%)					
95-97.5	80-82.5	65-67.5	50-52.5	35-37.5	
92.5-95	77.5-80	62.5-65	47.5-50	32.5-35	
90-92.5	75-77.5	60-62.5	45-47.5	<32.5	
87.5-90	72.5-75	57.5-60	42.5-45		
85-87.5	70-72.5	55-57.5	40-42.5		
82.5-85	67.5-70	52.5-55	37.5-40		

LEGEND - Raw Ash (%)
30

CLIENT



resourcing the future

Illawarra Coal

PROJECT

NAME
ILLAWARRA COAL - COMPETENT PERSONS REPORT

DRAWING
RAW ASH AND COKING PRODUCT YIELD - BSO

FIGURE No. 5.3	PROJECT No. ADV-SY-04120	Date March 2015
-------------------	-----------------------------	--------------------

285000 m

290000 m

295000 m

300000 m

305000 m

6100061.9

6100061.9

6100061.9

6100061.9

6100061.9

6100061.9

6100061.9

6100061.9

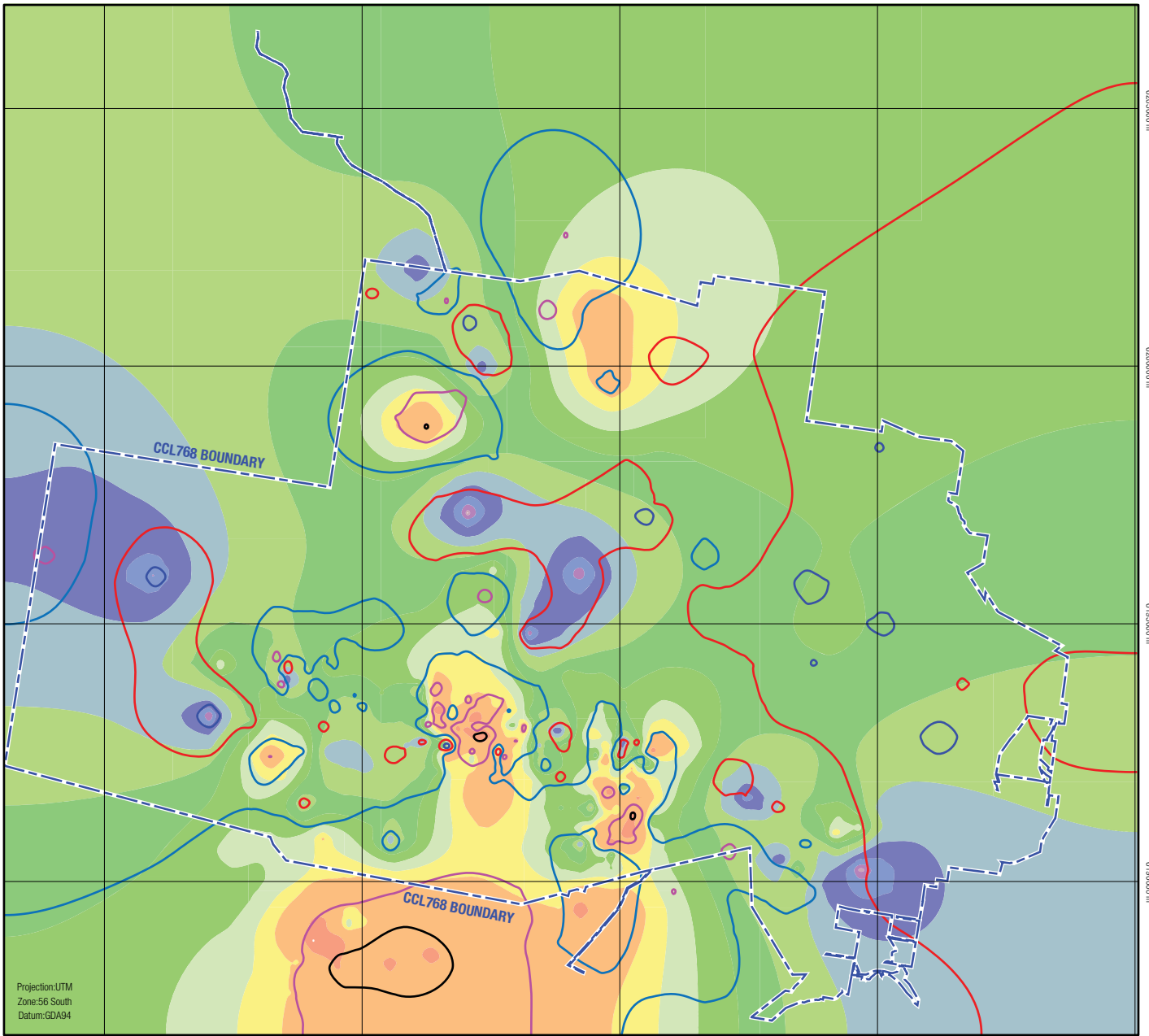

285000 m

290000 m

295000 m

300000 m

305000 m

Runge Pincock Minarco

LEGEND - Coke Yield (%)			
60 - 62.5	47.5 - 50	35 - 37.5	
57.5 - 60	45 - 47.5	32.5 - 35	
55 - 57.5	42.5 - 45	30 - 32.5	
52.5 - 55	40 - 42.5	27.5 - 30	
50 - 52.5	37.5 - 40	<27.5	

LEGEND - Raw Ash (%)	
32.5	—
30.0	—
27.5	—
25.0	—
22.5	—

CLIENT PROJECT



NAME
ILLAWARRA COAL - COMPETENT PERSONS REPORT

DRAWING
RAW ASH AND COKING PRODUCT YIELD - DENDROBIUM

FIGURE No. 5.4	PROJECT No. ADV-SY-04120	Date March 2015
-------------------	-----------------------------	--------------------

DO NOT SCALE THIS DRAWING - USE FIGURED DIMENSIONS ONLY VERIFY ALL DIMENSIONS ON SITE

5.2.2 Potential Mining Method and Prospects for Eventual Economic Extraction

The potential mining method for the extraction of the Coal Resource is underground longwall mining. This method is a proven method for the Project over a long period of operation. There are no open cut Coal Resources.

5.2.3 Resource Criteria

Coal Resources have been estimated for the Bulli Seams at the BSO using the below criteria:

- The Bulli Seam has previously been mined to a minimum thickness of 1.5 m. This is also the minimum seam thickness within the planned mining areas. As such, a minimum seam thickness has not been applied for the Appin estimate;
- Gas at depth is considered to be manageable and Illawarra Coal can demonstrate that they have mined 550 m depths for several years, as such no maximum depth of cover was utilised; and,
- Coal quality is seen to be consistent across the deposit for the Bulli Seam, particularly in planned areas of mining and as such no coal quality cut off have been applied;

Coal Resources for the Wongawilli Seam have been estimated for the Dendrobium Operation using the below criteria:

- Areas where subsidence from longwall mining would create unacceptable surface impact have been excluded from the estimate of Resources. This includes areas where there is considered no reasonable prospects of extraction due to surface constraints associated with Lake Cordeaux, Lake Avon and the exclusion zones around the Lake Cordeaux Dam Wall;
- The Wongawilli Seam Coal Resources are estimated for a 2.5 m to 4.5 m thick working section within a total coal seam thickness of approximately 9 m. The working section has been identified as the most economic portion of the seam most likely to be recovered, resulting in the exclusion of the rest of the seam. The working section is very consistent and does not vary outside of these 2.5 m to 4.5 m ranges within the Project area, which means it is recoverable by current longwall equipment and operations.
- No coal quality cut offs have been applied;
- Within the Project area, depth of cover is between 96 m to 500 m. Depth of cover is not considered a major barrier to mining based on previous operating experience and, as a result, no seam depth cut offs have been applied; and,
- Areas where the Wongawilli Seam has previously been extensively mined have been excluded.

No other assumptions or cut-offs were considered. Illawarra Coal do not exclude resources beneath residential areas, main roads and highways, but include them in the model as potential areas where resources may be excluded if required as mining methods account for any sensitive areas. One exception is that the area beneath the major town (Camden) in the north of Appin Area 7 has been excluded from estimates.

The constraints that have been applied to the estimation of Coal Resources are specific to the identified mining methods and the site specific geology and are considered appropriate.

5.2.4 Resource Categorisation

Illawarra Coal reported the Coal Resources as a combination of Measured, Indicated and Inferred Resource categories as per the definitions set out in the JORC Code. The Resource Categorisation areas were primarily based on distances from Points of Observations and other supporting criteria. The Points of Observation for this Project primarily consist of drill-holes but also include underground strip samples collected from the existing workings.

Drill-hole data has been collected over a long period and has been classified in accordance with a reliability ranking, specifically with respect to the current product specification delivered from the operation, as follows:

- Highest categorisation of Inferred - Basic raw (proximate analyses) with no float or sink;
- Highest categorisation of Indicated - Proximate or ultimate analyses with float sink but no ash analyses;
- Highest categorisation of Measured - As above with pre-treatment plus ash analyses; or drill-holes that have been drilled post 2000.

5.2.5 Point of Observation Spacing

The appropriate distances between Points of Observations were determined through geo-statistical studies carried out on key coal parameters including seam thickness, relative density, plant simulated yield, ash, vitrinite, and sulphur.

The Geo-variances (2011) report endorsed using the following distances between Points of Observations for each Resource Category, in line with Illawarra Coal's existing practice:

- Measured – 700 m (circle with radius of 350 m of influence around point of observation);
- Indicated – 1,500 m (circle with radius of 750 m of influence around point of observation); and,
- Inferred – 4,000 m (circle with radius of 2,000 m of influence around point of observation).

RPM completed a high level review of the geo-statistical study outlining the method for determining the corresponding distances used for resource categorisation and considers this method to be appropriate.

The other requirement for Resource Categorisation is for the Resource areas to be supported by 2D and/or 3D seismic surveys or Surface to In-Seam (STIS) drilling to ensure the lateral continuity of the seam and the identification of structures that would prevent economic extraction of the Resource using conventional longwall operations. The Seismic Data and STIS drilling requirements for Resources Categorisation used are:

- Measured – 3D seismic coverage or within 250 m of a high resolution 2D line/STIS drilling;
- Indicated - 3D seismic coverage or within 500 m of a high resolution 2D line/STIS drilling; and
- Inferred – no requirement for seismic or STIS drilling to support Inferred resource categorisation.

The methodology followed by Illawarra Coal also excludes areas of previous mining, potential resources beneath environmentally sensitive areas and downgrading resources if they are adversely affected by intrusions or faulting. RPM considers the method used to determine the Resource categorisations as appropriate for the Project.

5.2.6 BSO Coal Resource Estimate Review

The Coal Resources estimated for the Bulli Seam at the BSO, as at 30th June 2014, are shown in Table 5-2 and the corresponding Resource Categorisation areas are shown in Figure 5-5. Illawarra Coal reports Coal Resources inclusive of Coal Reserves.

RPM reviewed the resource polygons as supplied in the current MineScape project to ensure the suitability of the report quantities in Table 5-2. The following observations were noted:

- RPM could not exactly match the Measured and Indicated polygon shapes for Appin. The polygons created from observations with coal quality by RPM varied slightly to Illawarra Coal's polygons. Overall they were very similar and RPM considers any variations in the interpretation will not result in a material variation in the quantities reported;
- There are areas of Indicated Resources that have been downgraded to Inferred by Illawarra Coal. This is predominantly adjacent to faulting and is documented in the 2014 Resource and Reserves Report
- There are small portions of Inferred Resources where Illawarra Coal appears to have been conservative in the Resource categorisation. The available data is likely representative of Indicated Resources, however Illawarra Coal has decided to categorise them as Inferred.

RPM re-estimated the BSO Resources using the polygons supplied by Illawarra Coal and also re-estimated the coal quality values. In both cases RPM's re-estimation results were well within the acceptable range of accuracy compared to Illawarra Coal's reported BSO estimates.

5.2.7 Dendrobium Operation Coal Resource Estimate Review

The Resource Estimate for the Wongawilli Seam at the Dendrobium Operation is shown in Table 5-2 and relates to the main seam working section WON_11_2M shown on Figure 4-3. The corresponding Resource Categorisation areas for this working section are shown in Figure 5-6. It is noted that the seam sections immediately above and below the main working section have been included in the Resource for a relatively small area within the Dendrobium operation as these could potentially be mined with the main working section. Illawarra Coal reported the Coal Resources inclusive of the Coal Reserves.

Coal Resources for the Dendrobium and the Cordeaux mine (CCL768) are exclusively contained within the Wongawilli Seam.

Resources were estimated using an estimated in-situ density calculated using the Preston Sanders method (using Moisture Holding Capacity to represent Moisture Insitu). This is considered an appropriate way of estimating Resources.

5.2.8 Resource Reporting Review

RPM considers that the Illawarra Coal 2014 Resource Report is generally in accordance with the provisions of the JORC Code (although in RPM's view additional information with regard to the description of geological data used in the resource estimation including how the data was collected, description of drilling techniques, the number of holes used in the resource definition and what data was excluded from the dataset ought to also have been included).

RPM completed a re-estimate of each asset using the information provided and the methodology stated in the 2014 Resource and Reserves Report. RPM compared the Resources for each category for the Project area and the associated qualities reported in the 2014 Resource and Reserves Report with RPM's re-estimate. RPM's estimate was consistent with the Coal Resources stated in the 2014 Resource and Reserves Report.

RPM notes some depletion has occurred through the continuation of mining operations between the date of the 2014 Resource and Reserves Report and the preparation of the CPR. This depletion is shown in Table 5.3.

Table 5-2 – Coal Resources as at 30 June 2014 in 100% Terms (as Reported by Illawarra Coal)

Commodity Deposit	Mining Method	Coal Type	Measured Resources				Indicated Resources				Inferred Resources				Total Resources				BHP Billiton Interest
			Mt	% Ash	% VM	% S	Mt	% Ash	% VM	% S	Mt	% Ash	% VM	% S	Mt	% Ash	% VM	% S	%
Appin	UG	Met/Th	157	11.2	23.8	0.37	256	12.6	24.2	0.36	289	13.5	23.8	0.36	702	12.7	24.0	0.36	100
West Cliff	UG	Met/Th	21	12.3	21.3	0.36	21	11.9	20.7	0.34	68	13.9	19.9	0.33	110	13.3	20.3	0.34	100
Dendrobium	UG	Met/Th	86	29.8	23.7	0.59	91	29.8	23.1	0.58	118	29.4	22.8	0.58	295	29.6	23.2	0.58	100
Cordeaux	UG	Met/Th	5.2	28.7	21.1	0.58	109	29.1	21.5	0.56	85	29.0	22.1	0.57	199	29.0	21.8	0.57	100

Note:

- The coal quality for Illawarra Coal is for insitu quality on an air-dried basis. Tonnages are on an insitu moisture basis. VM is volatile matter, and S is sulphur.
- No seam thickness cut-off because the minimum thickness is economic.

Source: BHP Billiton 2014 Annual Report

5.2.9 Coal Resource Status

Since the Coal Resources were reported on the 30th June 2014, mining has continued within the area of defined Coal Resources. The quantity of Coal Resource forecast to be depleted as at 31st December 2014 since 30th June 2014 is provided in Table 5-3. The depletion quantities shown in Table 5-3 are solely due to mining of the Coal Resource.

There have been no material changes to the Coal Resource since 30th June 2014.

Table 5-3 - Quantity of Depleted Coal Resource (30th June 2014 to 31st December 2014)

Site	Measured (Mt)	Indicated (Mt)	Inferred (Mt)	Total (Mt)
Appin	3.9	0.0	0.0	3.9
West Cliff	3.5	0.0	0.0	3.5
Dendrobium	6.5	0.0	0.0	6.5
Cordeaux	0.0	0.0	0.0	0.0
Total	13.9	0.0	0.0	13.9

Source: *Supplied by Illawarra Coal*

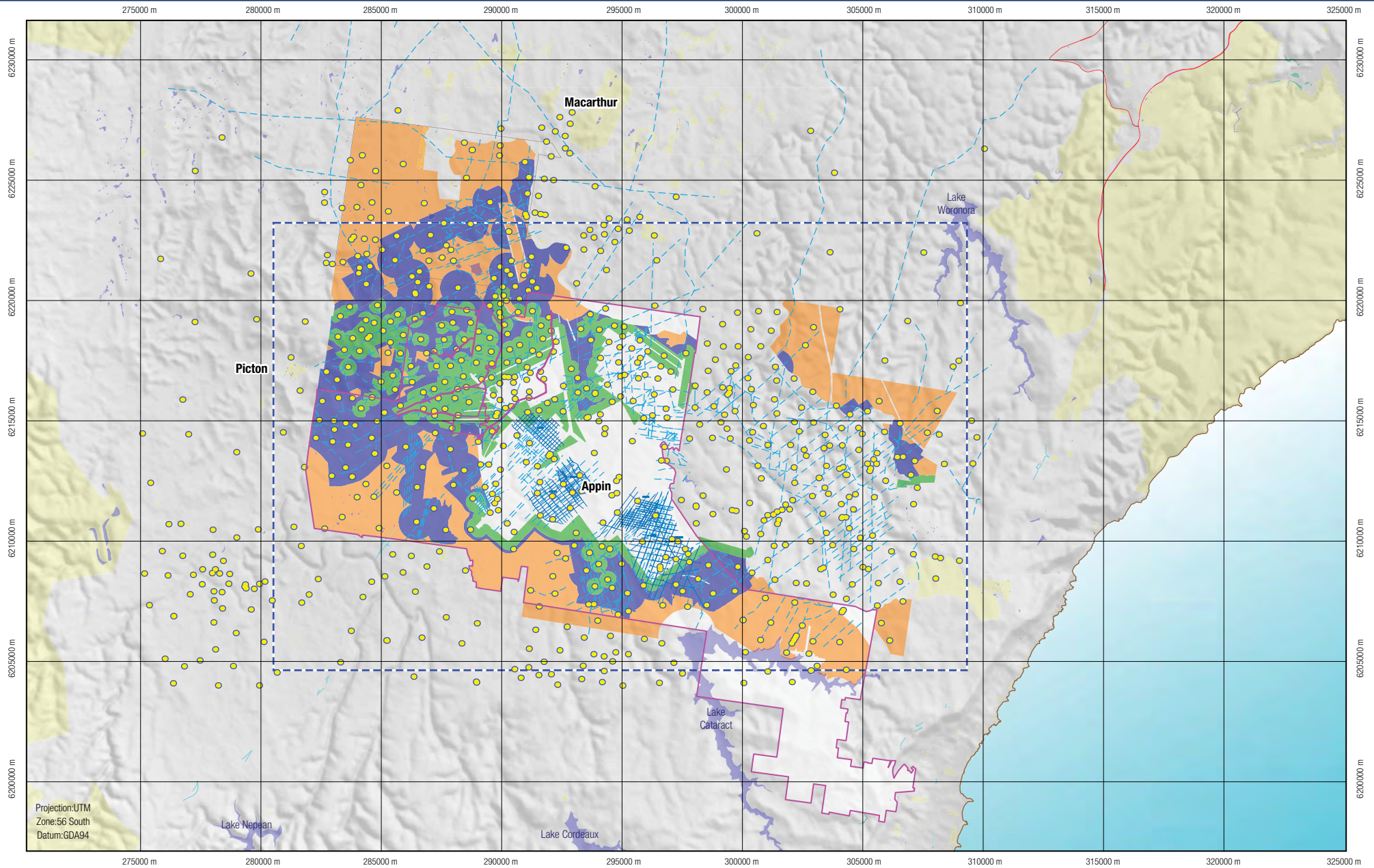

Projection: UTM
 Zone: 56 South
 Datum: GDA94

LEGEND		
	CCL767 boundary	
	Model Limit	
	2D Seismic Lines	
	3D Seismic Lines	
	Drillholes	
	National Park	

0 10
 DO NOT SCALE THIS DRAWING - USE FIGURED DIMENSIONS ONLY. VERIFY ALL DIMENSIONS ON SITE. km

CLIENT

resourcing the future
 Illawarra Coal

PROJECT

NAME
ILLAWARRA COAL - COMPETENT PERSONS REPORT

DRAWING
 RESOURCE CATEGORISATION AREAS - BULLI SEAM

FIGURE No. 5.5	PROJECT No. ADV-SY-04120	Date March 2015
-------------------	-----------------------------	--------------------

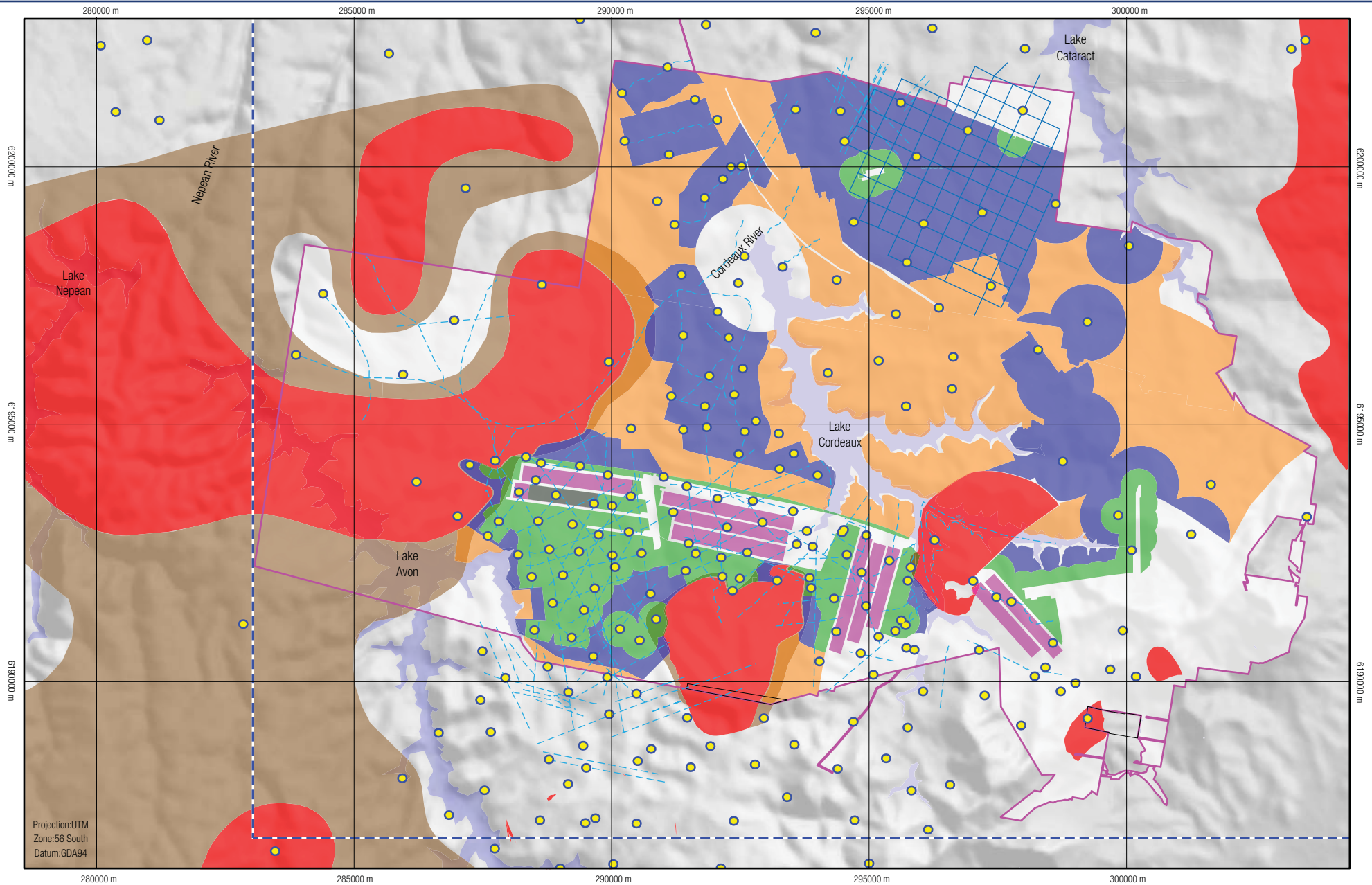

Projection: UTM
 Zone: 56 South
 Datum: GDA94

LEGEND

- | | | | |
|------------------|------------------|--------------------|---|
| CCL768 boundary | 3D Seismic Lines | Measured Resource | Sill affected WW Working Section |
| Model Limit | Drillholes | Indicated Resource | Sill affected WW seam above Working Section |
| 2D Seismic Lines | | Inferred Resource | Mined Out Areas |



CLIENT

PROJECT

NAME
ILLAWARRA COAL - COMPETENT PERSONS REPORT

DRAWING
 RESOURCE CATEGORISATION AREAS - WON_11_2M DENDROBIUM

FIGURE No. 5.6	PROJECT No. ADV-SY-04120	Date March 2015
-------------------	-----------------------------	--------------------

6 JORC Coal Reserves Review

The 2014 Resource and Reserves Report included Coal Reserve estimates for the BSO and Dendrobium Operation. The Competent Persons for the Coal Reserves was Mr Matthew Rose. RPM considers that the Competent Person meets the competence criteria as described in the JORC Code.

6.1 Estimate Methodology

A common Coal Reserve estimation methodology was applied to the BSO and the Dendrobium Operation as outlined below:

- The Coal Resource was sourced from the models developed for the 2014 Coal Resources by Illawarra Coal. The geological quality and structure grids were exported from MineScape and imported into the XPAC Underground Solution;
- A mine layout was created in the XPAC Underground Coal Design Module, as part of the ongoing development of the Project. This combined with other criteria such as location of faults and dykes, lease boundaries, surface subsidence restrictions etc. were used to develop the mine layout, consisting of development panels and longwall panels;
- Each of the designed longwall panels was subdivided into scheduling blocks, which were then allocated the various values for that scheduling block from the structure and quality grids;
- The scheduling blocks and relevant structure and quality values were exported from XPAC Underground Coal Design Module and subsequently imported into XPAC for processing and scheduling. Modifying factors such as minimum and maximum mining thickness, coal loss and dilution factors and processing and blending assumptions are incorporated into the XPAC model. The *in situ* and ROM tonnes within the mine layout were then estimated and yield estimates applied to estimate product tonnes (coking and thermal);
- Detailed production scheduling was carried out in the XPAC model, with equipment and other resources being allocated to enable delivery of the production schedule which then allowed a capital cost schedule and an operating cost schedule to be derived for the production schedule;
- An economic model was constructed with the project cash flow and NPV being determined. Analysis of the economic model outcomes confirmed the economic viability of the mine. The Coal Resource geological confidence limits of Measured, Indicated and Inferred polygons were overlaid on the mine plan and any Inferred or unclassified Resources excluded from the estimate. The Coal Reserve was categorised as Proved or Probable based on the Coal Resource confidence, application of modifying factors and the level of detail in the mine planning.
- Coal Reserves were reported in a 2014 Resource and Reserves Report which reports JORC Coal Resources and Coal Reserves as at 30 June 2014 in accordance with the JORC Code.

6.2 Bulli Seam Operation Estimate Review

6.2.1 Mining Factors

CCL767, in which the BSO are located, covers an area approximately 28 km long (North - South), and 26 km wide (East-West), with the main body of CCL767 being approximately 20 km long (North-South), and 17 km wide (East-West). The physical mining constraints used to determine the underground target area for the BSO were the consent boundary to the north and west, existing workings to the east, and seam thinning to the south.

Typical parameters used for the mine plan layout include:

- Main headings roadways: 4 - 8
- Gateroad panel roadways: 2

- Main headings pillar length (centres): 70 – 125 m
- Main headings pillar width (centres): 30 – 125 m
- Gateroad pillar length (centres): 125 m
- Gateroad pillar width (centres): 37 - 60 m
- Roadway width: 5.0 – 5.2 m
- Roadway height: 2.4 – 3.4 m
- Longwall panel width (block width): 272 - 355 m
- Longwall extraction height: 2.2 – 3.7 m

Through the application of a mine plan and mining factors, the Mineable *In Situ* coal within the target area was converted to ROM coal quantities which were then checked so that only Measured and Indicated Coal Resources were classified as Coal Reserves. The coal quantities within the mine layout were converted to Coal Reserves after the application of mining factors such as loss, dilution and minimum seam thickness.

BSO applies the longwall mining method. Although the coal seam working section is reasonably well defined, it is not practical to mine the interface between the working section and the surrounding strata without incurring some loss and contamination of the coal. There will be times when some coal is left unintentionally unmined (loss) and other times when adjacent strata are mined as coal (dilution).

Additional mining factors were applied to the Coal Resources model for deriving ROM Coal quantities. The approach to convert *in situ* to ROM coal and the application of mining factors involved the following:

- Roof and Floor Loss: It was assumed that an average of 50 mm of in situ working section coal will be lost from the roof and/or floor of the mineable coal sections during development and longwall extraction;
- Roof and Floor Dilution: It was assumed that an average of 200 mm of waste material will be mined with the coal seam during development and longwall mining (up to 250 mm in Area 5), thereby diluting the in situ coal quality. Additional dilution is extracted in areas where the seam thickness is less than the minimum cutting height of the development or longwall equipment. The quality defaults assigned to the waste rock were assumed to be relative density of 2.5 t/cu.m, and ash of 100%; and,
- Moisture: Relative density data in the geological model is based on assumed in-situ moisture of 2.0%, while all qualities are based on air-dried moisture gridded values. The Preston Sanders formula has been used to adjust the sampled relative density for the constant insitu moisture adopted in the model. ROM moisture is assumed to be 6%, and product moisture is assumed to be 9% for coking coal and 7% for thermal coal.

6.2.2 Metallurgical Factors

All coal produced at the BSO is processed at the West Cliff Coal Preparation Plant, which incorporates:

- Dense medium drum;
- Primary dense medium cyclone (“DMC”);
- Secondary DMC;
- Froth flotation cells;
- Thickening cyclone; and,

- Horizontal belt filters.

Further details of the metallurgical factors can be found in **Section 9** of this CPR.

6.2.3 Cost and Revenue Factors

RPM are of the opinion that the underlying economics of BSO are positive. Further detail of the cost and revenue factors applicable to BSO can be found in **Section 11** of this CPR.

6.2.4 BSO Estimate Conclusions

An assessment of the geological conditions at the operations has been outlined in the 2014 Resource and Reserves Report. The main geological features to have an influence on the mine plan, and by extension the potential Reserves, include a number of faults and dykes located centrally within the target area. RPM are of the opinion that the mine plan accounts for these features adequately. RPM is of the opinion that the applied mining factors are reasonable for the given geological and mining conditions present at BSO.

Reserves may only be assigned Proved status if all mining approvals, including subsidence management plans are in place. Subsidence management plans are typically only approved by the regulator within a five-year window of mining. For this reason 48 Mt of Measured Resources at Appin has been classified as Probable Reserves. Due to the limited remaining mine life there has been no downgrading during the Resource to Reserve conversion at West Cliff.

Although RPM considers the estimation methodology to be industry standard and the resultant quantities reasonable, RPM notes that the depth of cover for the Bulli Seam target areas varies from 410 m to a maximum 840 m. The deeper areas are at the upper end of underground coal mining in Australia and are likely to be more challenging for mining than the shallower areas. A successful outcome will be dependent on appropriate roadway support systems being implemented and managed on an ongoing basis. Precise changes to the strata management plans will be determined through the acquisition of rock mechanic testing data and analysis, in conjunction with knowledge of the local strata behaviour.

6.3 Dendrobium Operation Estimate Review

RPM's review of the Coal Reserves involved a review of the relevant 2014 XPAC model. As the Dendrobium mine is in the process of transitioning to a new layout RPM also reviewed the XPAC reforecast model. It was noted that the mine layout in the reforecast model results in reduced ROM and product coal tonnes compared to the mine layout applied to estimate 2014 Coal Reserves.

6.3.1 Mining Factors

CCL768, in which Dendrobium Mine operates, covers an area approximately 14 km long (North-South), and 23 km wide (East-West). The physical mining constraints used to determine the underground target area for Area 3B were a significant dyke swarm to the north, an igneous intrusion to the east, the protection zone for Avon Dam to the west and the lease boundary to the south.

The mine layout has been prepared predominantly in areas defined as Measured and Indicated Resources. The proposed layout extends beyond these areas into Inferred Resources in a couple of small locations.

Main headings have been driven from the pit bottom area to gain access to the target area. Additional main headings are currently being driven south into Area 3B to facilitate the extraction of the area.

Typical parameters used for the mine plan layout include:

- Main headings roadways: 4 - 5
- Gateroad panel roadways: 2
- Main headings pillar length (centres): 80 – 125 m
- Main headings pillar width (centres): 45 m

- Gateroad pillar length (centres): 120 m
- Gateroad pillar width (centres): 50 m
- Roadway width: 5 m
- Roadway height: 3.3 – 3.5 m
- Longwall panel width (block width): 294.8 m
- Longwall extraction height: up to 4.6 m

The same method for converting In Situ coal to Coal Reserves applied to the BSO Coal Reserves (and previously described) was applied to the Dendrobium Reserves.

Additional mining factors were applied to the Coal Resources model for deriving ROM Coal quantities. The approach to convert *in situ* to ROM coal and the application of mining factors involved the following:

- Roof and Floor Loss: It was assumed that an average of 2.7% of in situ working section coal will be lost from the roof and/or floor of the mineable coal sections during longwall extraction.
- Roof and Floor Dilution: It was assumed that an average of 70 mm of waste material will be mined with the coal seam during development, thereby diluting the in situ coal quality. It was also assumed that an average of 110 mm of waste material will be mined with the coal seam during longwall extraction. The quality defaults assigned to the waste rock were assumed to be relative density of 1.9 t/cu.m, and ash of 75%.
- Moisture: Relative density data in the geological model is based on assumed in-situ moisture of 2.5%, while all qualities are based on air-dried moisture gridded values. Preston Sanders formula has been used in the estimation of in situ density. ROM moisture was assumed to be 7%, and product moisture was assumed to be 13.5%. RPM notes that the product moisture assumption has since been updated to 15.5% with the completion of the 30th June Coal Reserves.

6.3.2 Metallurgical Factors

All coal produced at Dendrobium is processed at the Dendrobium Coal Processing Plant, which incorporates:

- Heavy medium drum;
- Primary dense medium cyclone (“DMC”);
- Secondary DMC;
- Froth flotation cells;
- Drum filters;
- Horizontal belt filters; and,
- Media fluid bed dryer.

The Competent Person Report indicates that current processing of Dendrobium coal is to a nominal 10.1% coking coal ash.

6.3.3 Cost and Revenue Factors

RPM is of the opinion that the underlying economics of the Dendrobium Operation are positive. Further details of the cost and revenue factors applicable to the Dendrobium Operation can be found in **Section 11 and 12** of this CPR.

6.3.4 Dendrobium Estimate Conclusion

An assessment of the geological conditions at the mine has been outlined in the 2014 Resource and Reserves Report. The main geological features that may have an influence on the mine plan and potential reserves include a dyke swarm to the north and silling to the east. There is also a fault which traverses some of the longwall panels (LW16, LW17 and LW18) and it is Illawarra Coal's intention to mine through the fault in these panels. Given the thickness of the Wongawilli Seam, this appears to be a reasonable proposal. In addition the depth of cover for the Wongawilli Seam target area ranges from 230 m to a maximum 415 m. These depths are not considered likely to create any major impediments to mining.

Reserves may only be assigned Proved status if all mining approvals, including subsidence management plans are in place. Subsidence management plans are typically only approved by the regulator within a five-year window of mining. For this reason 17 Mt of Measured Resources at Dendrobium has been classified as Probable Reserves.

RPM understands that there are discrepancies between the relevant 2014 XPAC model and the reforecast XPAC model, particularly in relation to operating height ranges for development and longwall equipment.

Based on RPM's review of the Reserves, RPM has made the following adjustments to the life of mine schedule applied to the Reserve Valuation:

- Dilution increased by 100% for development and 50% for the longwall;
- Coking yield reduced by 10%;
- Total yield reduced by 5%; and,
- Development and longwall production rates reduced by 25%.

LW18 is also located in proximity to geological faulting along the edge of CCL768. Development and longwall production rates have been reduced by 15% for this panel.

RPM estimates that the mine design changes result in a 6% reduction in the Coal Reserves for the Dendrobium Mine. However, as this is only a 1% reduction in total Coal Reserves over the Project it is not considered to be a material change. Additionally, the reduction to the ROM coal reserves is offset by the increase to the product moisture assumption, resulting in only a small difference to the Dendrobium marketable coal reserves.

RPM note that the calorific value of the Marketable Coal Reserves for the thermal coal product from Dendrobium have not been public reported. Based on information provided to RPM, this has been estimated at 26.60 MJ/kg, product coal at 7% moisture levels.

The changes to the life of mine schedule outlined above are incorporated in the production schedule and mine plan presented in **Section 7 and 9** of this CPR. The quality of the coal within Area 3B generally improves to the south such that as mining progresses, inherent ash reduces and coking yield increases. The impact of additional dilution within the ROM feed due to faulting within the area, only partially offsets these benefits and as such the quality of the mine product can be maintained through this area.

6.4 Coal Reserves

Coal Reserves as estimated by Illawarra Coal and reported as at 30th June 2014 are shown in Table 6-1.

Table 6-1 - Coal Reserves as at 30 June 2014 in 100% Terms (as Reported by Illawarra Coal)

Commodity Deposit	Mining Method	Coal Type	Proved Coal Reserve	Probable Coal Reserve	Total Coal Reserve	Proved Marketable Coal Reserve				Probable Marketable Coal Reserve				Total Marketable Coal Reserve				Reserve Life	BHP Billiton Interest
			Mt	Mt	Mt	Mt	% Ash	% VM	% S	Mt	% Ash	% VM	% S	Mt	% Ash	% VM	% S	Years	
Appin	UG	Met/Th	24	133	157	20	8.9	23.5	0.37	112	8.9	24.9	0.36	132	8.9	24.7	0.36	25	100%
West Cliff	UG	Met/Th	5.4	0.4	5.8	3.8	8.9	20.6	0.36	0.3	8.9	20.1	0.36	4.1	8.9	20.6	0.36	2	100%
Dendrobium	UG	Met	21	24	45	8.6	9.7	23.8	0.59	9.9	9.7	24.2	0.59	18	9.7	24.0	0.59	8.9	100%
		Th				5.2	23.0			6.3	23.0			12	23.0				

Notes:

- Only geo-physically logged, fully analysed cored holes with greater than 95% recovery were used to classify the reserves. Drill hole spacings vary between seams and geological domains and were determined in conjunction with geo-statistical analyses where applicable. The range of maximum spacings was: Appin: Proved - 700 m, Probable - 1,500 m, West Cliff: Proved -700 m, Probable - 1,500 m, Dendrobium: Proved -700 m, Probable - 1,500m

- Product Recovery for the operations were Appin - 84%, West Cliff - 71%, Dendrobium - 67%

- Total Coal Reserves are at the moisture content when mined of; Appin and West Cliff - 6%, Dendrobium -7%. Total Marketable Coal Reserves are the tonnes of coal available, at a moisture content of; Appin and West Cliff – 9%; Dendrobium Met – 13.5% and Dendrobium Th – 7%, and air-dried qualities, for sale after the beneficiation of the Total Coal Reserves.

- Cut-off criteria applied: Appin, West Cliff, Dendrobium ≥ 1.8m seam thickness.

- Coal delivered to wash plant.

Source: BHP Billiton 2014 Annual Report

6.5 Coal Reserve Status

Since the Coal Reserves were reported on the 30th June 2014, mining has continued within the area of defined Coal Reserves. The quantity of Coal Reserves forecast to be depleted as at 31st December 2014 from 30th June 2014 is provided in Table 6-2. The depletion quantities shown in Table 6-2 are due solely to mining of the Coal Reserve.

Table 6-2 Quantity of Depleted Coal Reserve (30th June 2014 to 31st December 2014)

Asset	Reserve Depletion	
	ROM (Mt)	Marketable (Mt)
Appin Mine	1.9	1.7
West Cliff Mine	2.3	1.4
Dendrobium Mine	2.2	1.4
Total	6.4	4.5

Source: Supplied by Illawarra Coal

Additional to the Coal Reserve depletion, since the 30th June 2014 Coal Reserves estimate, the design of the main headings in the south of Area 3B (Dendrobium) have been re-aligned. The main heading realignment has also affected the adjacent longwall panels. As a result, RPM estimates that the Coal Reserves have been reduced by 2.5 Mt ROM. However, due to a change in moisture assumptions and yield modelling (which has resulted in an uplift in the total yield), the Dendrobium Marketable Coal Reserve quantities remain the same as those quoted on 30th June 2014.

7 Mining

7.1 Mining Overview

Underground longwall mining is conducted at the Project. The BSO mines the Bulli Seam, whilst Dendrobium Mine extracts the Wongawilli Seam. The Cordeaux Mine previously worked in the Bulli Seam and although Wongawilli Seam extraction may be considered from this site in the future, it is not currently scheduled within the Life of Asset Plan.

Illawarra Coal is currently undergoing a transition period with the planned closure of West Cliff Mine at the end of FY2016. This reduction in coal production will be replaced by new operations at Appin Area 9. This is a fundamental change for the BSO as it will transition from its current set up with two separate mines to a single, larger and more complex mine operating with two longwalls. Upon completion of Appin Area 9, operations are planned to transition into Area 8, the access to which has largely been completed as part of the Area 9 expansion.

The mining of the Coal Reserves at the Dendrobium operation has been scheduled through to 2023. There are potential areas into which this operation may expand but due to technical challenges, primarily associated with mine gas, these have yet to be included in the Coal Reserves and subsequent mining schedule. Should it not be possible for Dendrobium to extend beyond 2023, the Illawarra Coal operations will be confined to Appin Mine, producing Bulli Seam coal from two longwalls.

The Illawarra Coal mining sequence is illustrated on Figure 7-1.

Figure 7-1 - Illawarra Coal Optimised Base Plan ROM Output

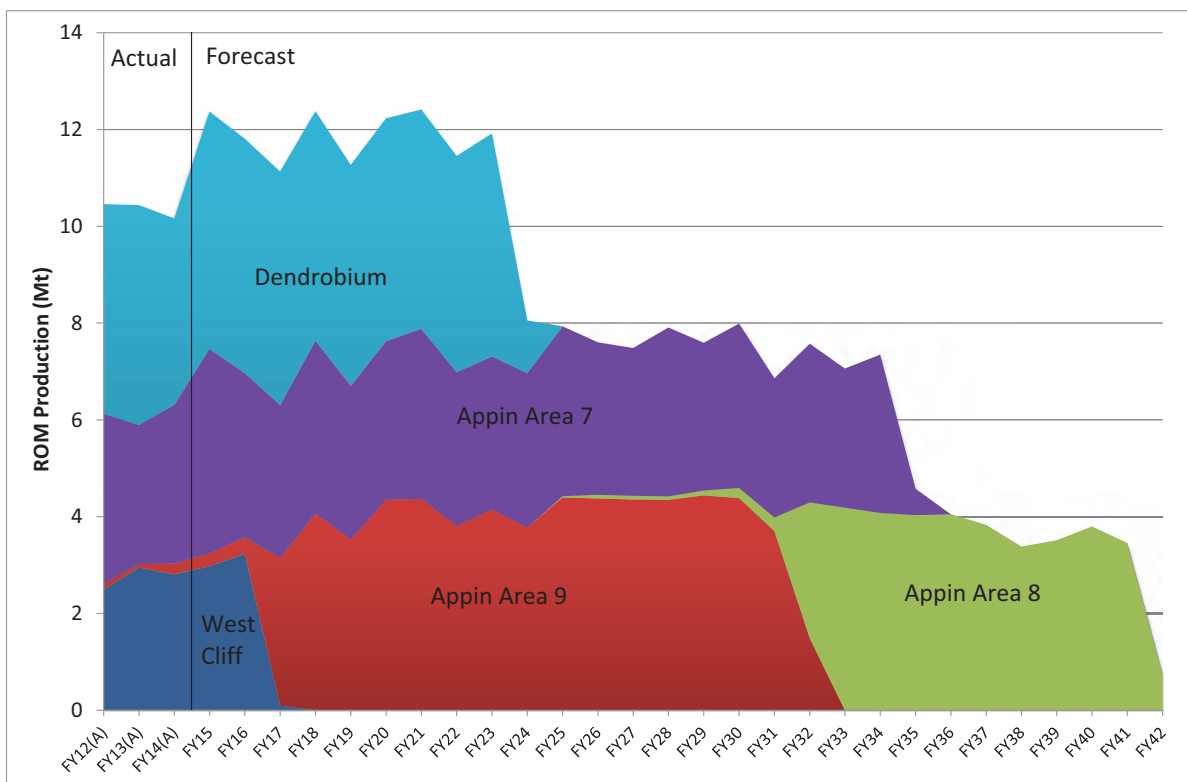

Source: RPM estimate based on Information Supplied by Illawarra Coal.

As shown on Table 7-1 the annual ROM output from Illawarra Coal is forecast to increase by up to 1.5 Mt in comparison to performance over the last three years. As shown in Table 7-1, this is initially driven by Dendrobium which is overcoming the geotechnical incidents that has recently constrained production and over the longer term through the establishment of higher productivity sections within the Appin complex.

Table 7-1 – Total Mine Production

ROM Coal Production		Actual			Forecast									
		FY12(A)	FY13(A)	FY14(A)	FY15	FY16	FY17	FY18	FY19	FY20- FY24	FY25- FY29	FY30- FY34	FY35- FY39	FY40- FY42
Total Output														
West Cliff	Mt (ROM)	2.50	2.95	2.81	2.97	3.23	0.10							
Area 7	Mt (ROM)	3.51	2.87	3.28	4.06	3.39	3.15	3.57	3.17	16.32	16.26	15.70	0.55	-
Area 8	Mt (ROM)										0.36	11.57	18.80	8.00
Area 9	Mt (ROM)	0.12	0.08	-	0.17	0.34	3.06	4.06	3.53	20.45	21.91	9.57	-	-
Dendrobium	Mt (ROM)	4.33	4.54	3.85	4.91	4.84	4.83	4.74	4.56	19.29				
Total	Mt (ROM)	10.46	10.44	9.94	12.10	11.81	11.13	12.38	11.27	56.07	38.53	36.84	19.35	8.00

Source: RPM estimate based on information supplied by Illawarra Coal.

7.2 Bulli Seam Operations

7.2.1 Mining Methods and Overview

The BSO incorporates the current and future expanded operations of both the Appin and West Cliff Mines. Illawarra Coal has operated the West Cliff Colliery since April 1997; prior to this the mine was owned and operated by CRA Limited. Underground mining at both the West Cliff and Appin operations is by conventional retreat longwall methods with planned annual outputs ranging from 3 Mt to 4 Mt.

The depth of cover over the current and future BSO workings ranges from a minimum of approximately 450 m in the West Cliff and Appin Area 7 to a maximum of about 850 m in Appin Area 9. This makes the BSO workings some of the deepest in Australia which is of significance to both the productivity of the development and longwall systems as well as the cost of extraction.

The Bulli Seam ranges in thickness from approximately 1.8 m in the current West Cliff area to 3.6 m in Appin Area 7 and the seam generally thickens from east to west across the mining area. The longwall working section generally follows the full-seam thickness although extraction is constrained to the specific equipment operating range working in area. Thus in the thinner parts of the resource the mining of stone (coal dilution) may be required, while in the thickest areas some coal will be left in the roof (coal loss).

Seam gas presents both a significant production and safety risk to BSO. Both surface to in seam (STIS) and underground in seam (UIS) gas drainage methods are employed in advance of mining, and the operation also employs a series of ventilation related gas management strategies to assist in mitigation of this risk. It should be noted that BSO has more than 40 years of experience in operating in a high gas environment and these mitigation practices are well established.

The existing and planned BSO workings are shown in Figure 7-2. The West Cliff Mine is currently mining in its penultimate longwall panel (LW37) in Area 5, and production from West Cliff's final panel (LW38) is planned to be completed by the end of April 2016. Upon completion of the West Cliff workings, operations will be relocated to the first panel in Appin Area 9 (LW901).

Appin Area 10 to the northwest of Areas 7 and 9, located outside the current Development Consent area, offers a potentially significant increase to the Life of Mine for the BSO and could take production beyond 2050. These areas do however, extend into very deep parts of the resource and, as such, are likely to experience more challenging mining conditions.

Mining in both Appin Area 7 and Area 9 is expected to encounter igneous intrusions and faulting. A dyke/sill feature has been identified within the Area 7 mine layout and it is believed that this formation extends through to panel LW710. These intrusions have been successfully negotiated in previous panels (LW704 and LW705) and RPM is of the opinion that the application of current processes will enable productive mining through these features.

There has been a steadily increasing trend in production performance at both West Cliff and Appin over the last decade. Production at both mines however, is artificially limited by the capacity constraints of the outbye coal clearance systems. The planned centralisation of operations within Appin whilst using coal clearance

through both West Cliff and Appin, offers greater system flexibility. Additional coal clearance system improvements are planned, to continue to de-constrain the production system.

7.2.2 Geotechnical Factors

The geotechnical conditions in Appin Area 7 and Appin Area 9 are relatively well understood from numerous studies and modelling conducted by a well-respected geotechnical engineering firm. These studies together with the long history of mining at Appin enable sound strategies to be developed to mitigate associated risks. RPM are of the opinion that the geotechnical risks associated with deeper mining have been sufficiently addressed, although it is likely that the combination of deteriorating roof/floor strength, increasing in situ vertical stresses and subtle changes in the orientation of the in situ horizontal stress direction, will present a challenge to development activities as mining progresses into these deeper areas. As a result it is expected that the levels of both roof and rib support will increase, which in turn is likely to impact on both the development rate and cost. Similar conditions may also impact longwall production and as a result it is expected that levels of secondary roof and floor support will also increase. The LOM Plan adequately accounts for the additional support requirements for mining at greater depths, with the associated increase in vertical stress.

Although large faults, that would interrupt longwall mining, exist within the BSO area, mine layouts have been designed to avoid these features. Further faults will likely be discovered and known faults better understood as exploration activity continues but faulting is not expected to significantly impede production over the life of the asset.

Igneous intrusions within or adjacent to the seam include sills and dykes, both of which can displace or burn portions of the seam to make it effectively unmineable. Sills that intrude along the plane of the seam, form a boundary to mining, whilst those above the seam can interfere with the caving process and create difficult mining conditions. Dykes form a vertical or near-vertical plane and may be mined around or through, depending on the hardness and thickness of the intrusion.

Dykes have been identified in both Appin Area 7 and Appin Area 9 and it is expected that these formations will need to be extracted in advance of longwall mining and the resulting void filled with a low strength cement material. There is existing experience at BSO in undertaking these operations however, they create an additional activity and cost to the operations.

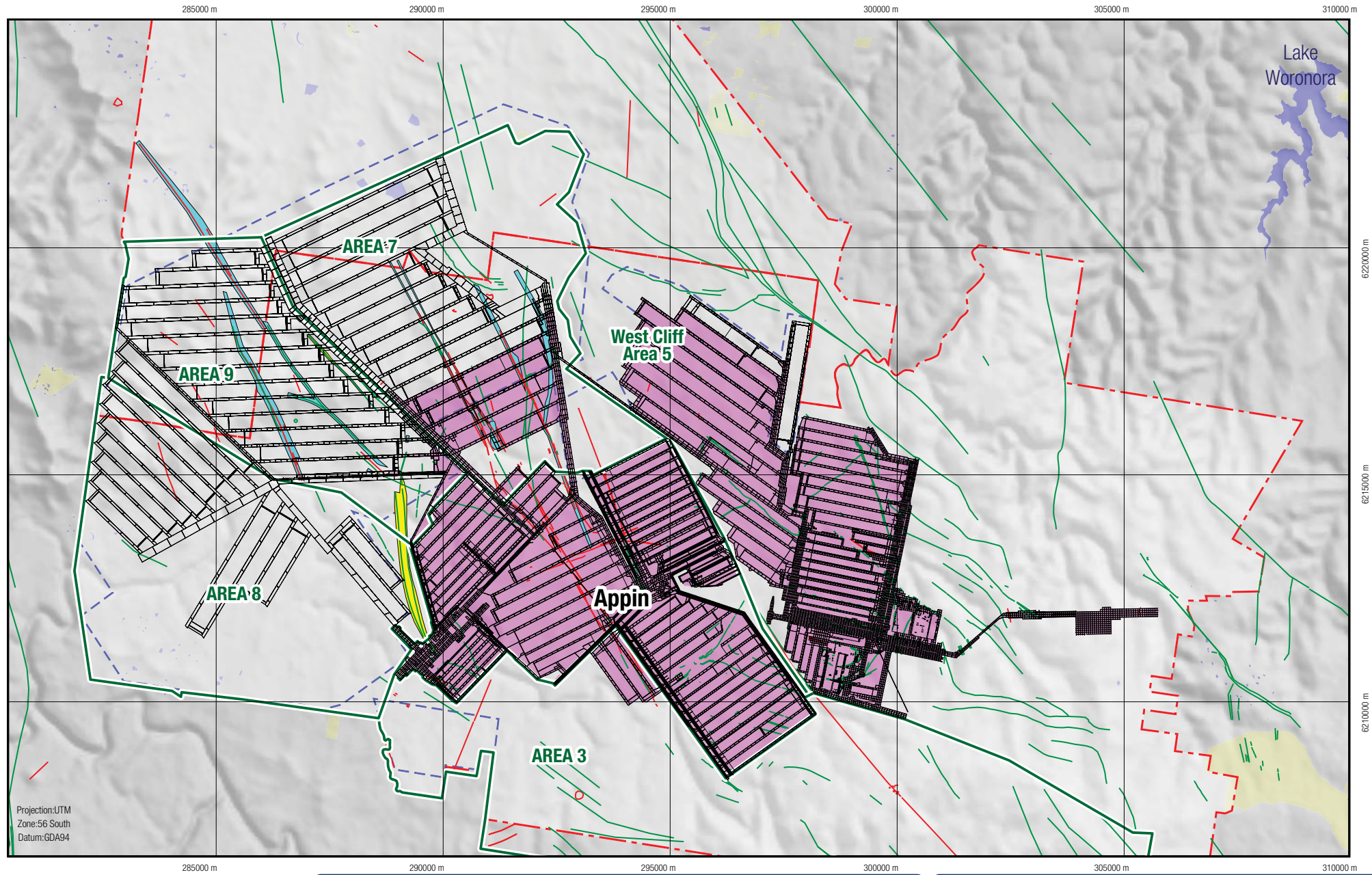

Projection: UTM
 Zone: 56 South
 Datum: GDA94

LEGEND		
	Illawarra Coal Held Boundaries	
	Development Consent Boundary	
	Faults	
	Dykes	

Derated Faults
 Derated Dykes
 BSO Approved Longwall Area
 Mined Out Areas
 National Park

0 5 km
 DO NOT SCALE THIS DRAWING - USE FIGURED DIMENSIONS ONLY. VERIFY ALL DIMENSIONS ON SITE

CLIENT

resourcing the future
 Illawarra Coal

PROJECT

NAME
ILLAWARRA COAL - COMPETENT PERSONS REPORT

DRAWING
 MINE LAYOUT - BSO

FIGURE No. 7.2	PROJECT No. ADV-SY-04120	Date March 2015
-------------------	-----------------------------	--------------------

7.2.3 Mine Gas Management

The gas environment within the BSO dictates that gas management must be well planned, properly resourced and well executed if the mines are to meet their potential production rates.

Technical Overview

Gas exists within the Bulli Seam, in the underlying seams and in overlying non-coal strata. The Bulli Seam virgin seam gas content ranges from 7 cu.m/t to 16 cu.m/t, and is typically reduced to 4 cu.m/t to 6 cu.m/t with pre-drainage of the seam. Gas composition is predominantly methane, with low proportions of carbon dioxide.

Gas drainage of the Bulli Seam is required to provide safe mining conditions, to remain in compliance with coal mining legislation and to provide the ability to meet planned production for both development and longwall extraction. Areas where higher in-situ gas content and lower permeability levels are encountered may require more intensive gas drainage and potentially longer drainage times.

Figure 7-3 and Figure 7-4 showing gas content and composition in the mining domains, indicate that the gas environment is expected to marginally improve over the life of Areas 7 and 9. The predominance of methane is indicated in Figure 7-4, with carbon dioxide significantly increasing in the north-east of Area 7. Knowledge of these parameters will improve as infill drilling is completed.

Timely and effective planning for gas management will be required, to ensure drainage and associated infrastructure is in place should gas conditions prove to be more aggressive than anticipated. Failure to do this is likely to result in increased gas delays that may adversely impact on production rates.

Depth of cover for the Bulli Seam ranges from 450 m to 850 m, increasing as mining progresses to the northwest. The GeoGAS database indicates that in the majority of underground operations in Australia, gas content increases with depth. As shown in Figure 7.3, this does not appear to be the case at Appin. Although additional exploration will help to improve the model detail, the overall trend is unlikely to significantly alter.

Permeability can be broadly defined as the rate that seam gas is emitted or flows from a specific location. It is a property of the rock or coal and normally decreases with increasing depth of cover as it is highly stress sensitive. Reduced permeability will relate to an associated reduction in seam gas desorption rate and may require a more intensive gas drainage program. Permeability is generally low in the BSO mining areas and reduces with depth.

Gas Drainage Practices

A range of gas drainage practices are employed at the site to reduce gas content and establish a safe and productive operating environment. Gas content, permeability and gas composition are all taken into account in designing the specific components and intensity of the gas drainage program.

The Appin operations use high density in seam gas drainage patterns in each longwall block, which is supplemented by surface to in seam ("STIS") drainage. Figure 7-5 illustrates the intensity of gas drilling required at Appin.

In addition, the BSO are required to manage gas migrating from strata both above and below the seam. In particular, the Wongawilli Seam, which lies below the Bulli Seam, is a significant gas reservoir feeding gas emissions during longwall operations and has historically been the primary cause of operational gas delays. Consequently, gas from the Wongawilli seam is the target of underground pre and post drainage programs, by cross measure drilling through the floor strata below the Bulli Seam.

Similarly, the gas from the Bulgo sandstone, located above the Bulli Seam, is the target of surface post drainage programs and has proved to be successful over the last few years. This has had a positive impact on production from the longwall with reduced gas delays experienced, and is planned as part as part of the ongoing gas management strategy.

Gas Drainage Controls

The gas management system includes documented and audited management plans, which lay out the controls for management of the risks associated with gas emissions. Methods, procedures and technical standards that are used to respond to gas conditions are detailed in these documents.

Figure 7-3 – Bulli Seam Contours – Gas Content (m³/t)

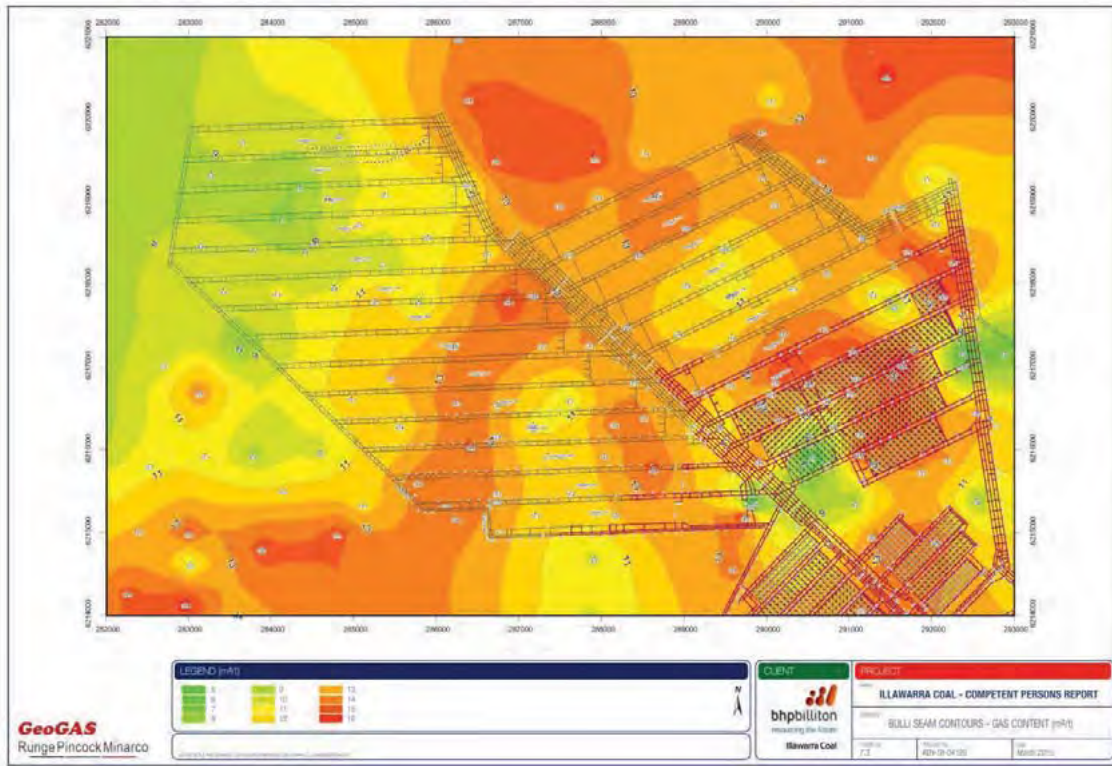
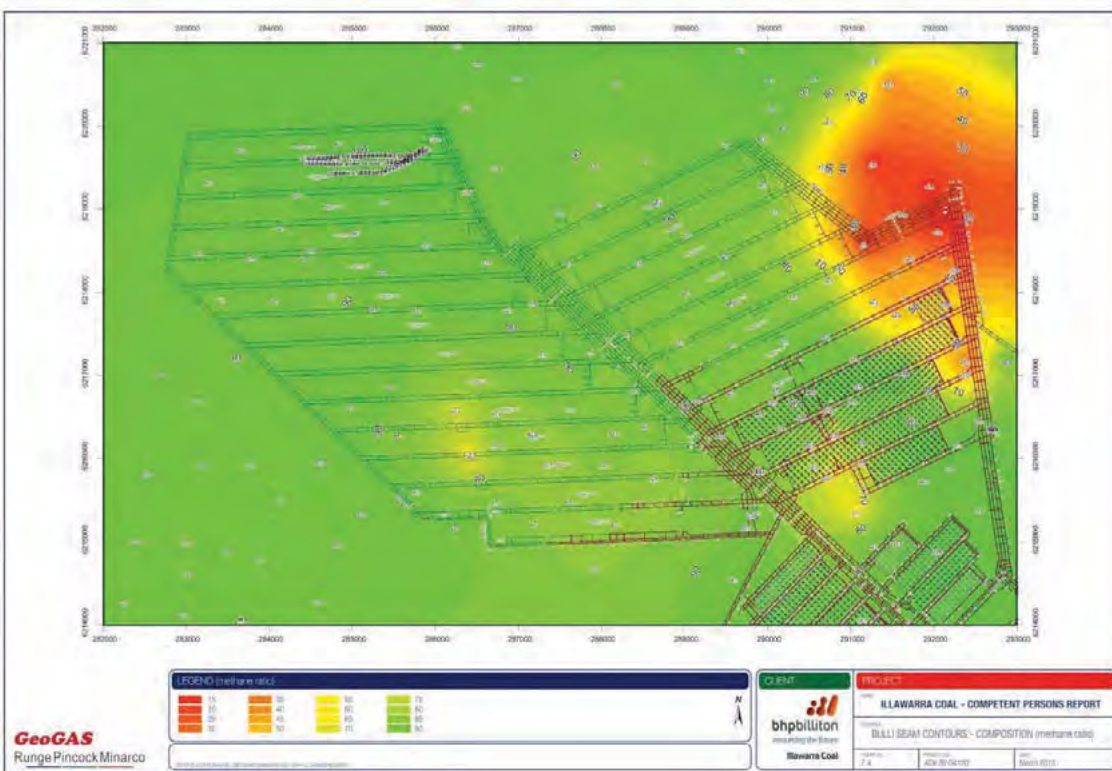
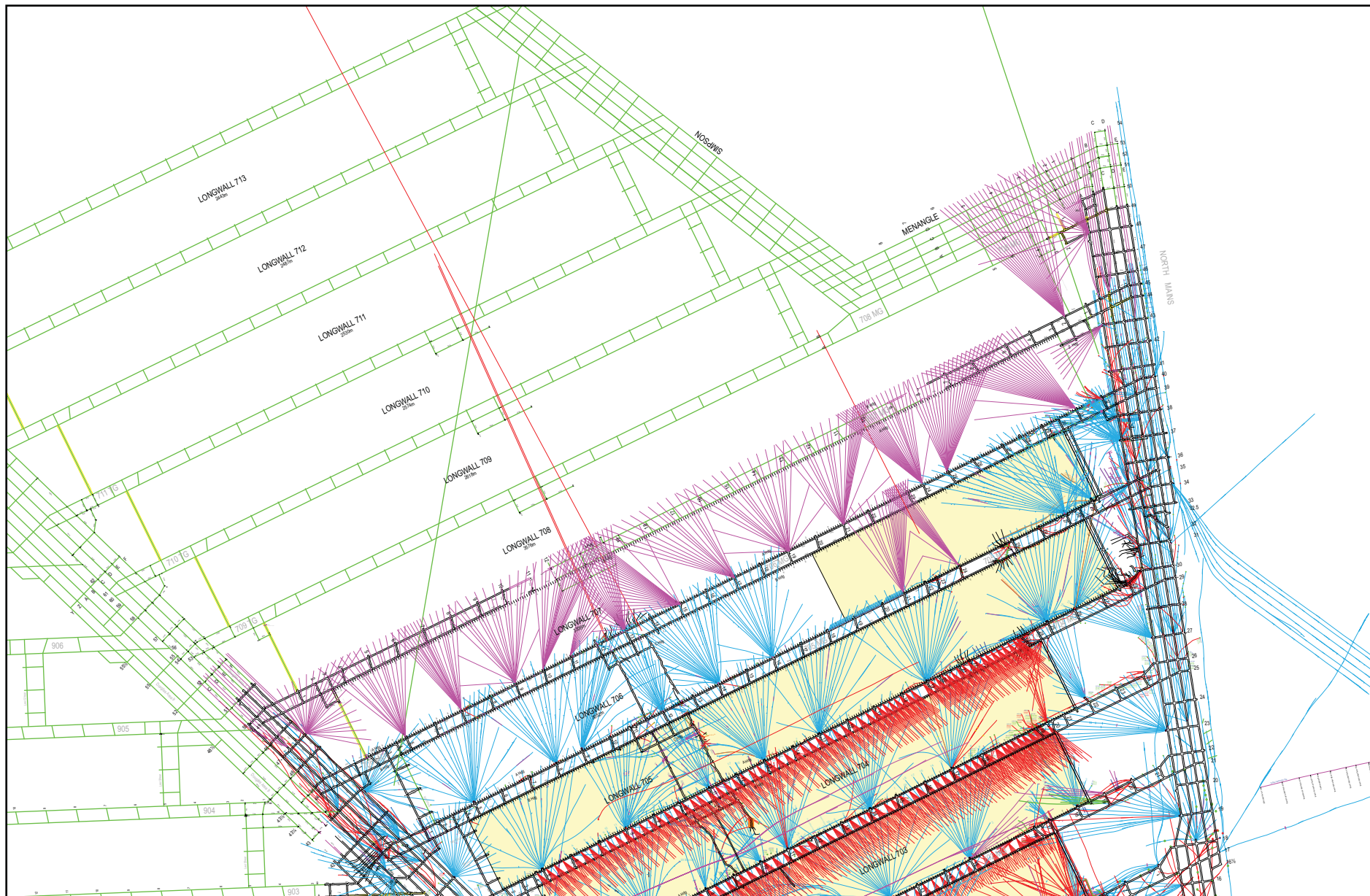

Figure 7-4 – Bulli Seam Contours – Composition (methane ratio)





LEGEND

- PLANNED IN-SEAM GAS DRAINAGE
- ACTUALS DRILLED IN-SEAM GAS DRAINAGE
- CROSS MEASURE
- MINED OUT LONGWALL



DO NOT SCALE THIS DRAWING - USE FIGURED DIMENSIONS ONLY. VERIFY ALL DIMENSIONS ON SITE.

CLIENT



PROJECT

NAME
ILLAWARRA COAL - COMPETENT PERSONS REPORT

DRAWING
SCHEDULED GAS DRAINAGE DRILLING - BSO

FIGURE No.
7.5

PROJECT No.
ADV-SY-04120

Date
March 2015

7.2.4 Mine Design and Operation

The layout of a longwall mine will significantly impact its overall production capacity. Factors such as panel width, panel length, cutting height, apparent panel grade, apparent panel cross grade and lateral extensiveness all have influence over the productivity of the longwall system.

The design of the Area 7 and Area 9 mine workings present as a logical extension to mining operations at Appin and West Cliff. The mine consists of a set of central (8 heading) mains that largely bisect the mining area with longwall panels extending off either side in a herringbone formation. Their orientation is largely selected to control the impact of the in situ horizontal stress direction.

Appin Area 7 has twelve remaining longwall panels which are approximately 315 m wide, while the fourteen panels in Area 9 are slightly narrower at 295 m. Due to either the limitations of the gas and ventilation system or the proximity of geological structure, none of the panels are longer than 3.5 km.

The design of Area 9 allows for easy extension to Area 8 to the south and extending the central mains will provide access into future mining areas to the north (Area 10).

Fundamental to the production from any longwall are the specifications of the longwall system. This includes not only the size and rated power of the longwall face equipment (generally referred to as the nameplate capacity), but also the capacity of the outbye coal clearance system. Development activities at BSO are carried out by a conventional bolter-miners and shuttle cars, while longwall extraction is undertaken by standard longwall equipment (powered supports and double ranging arm shearer).

BSO employs the uni-directional cutting system on the longwall. Although bi-directional cutting is more productive, constraints associated with gas emissions and the coal clearance dictate that the potential benefits from a change to this system are unlikely to be realised at the current time.

Area 7 and Area 9 will employ separate coal clearance systems with current mining in Area 7 delivering coal through the existing Appin coal clearance system and drift. Upon completion of mining at West Cliff and commencement of longwall mining in Area 9, coal clearance from Area 7 will be directed through the West Cliff conveyor network and coal from Area 9 will utilise the Appin coal clearance system.

7.2.5 Mine Schedules

The schedule for BSO can be broadly broken into three components, development, dyke extraction and longwall mining.

- The development schedule involves the sequencing of up to seven continuous miner units across the two main mining areas. Each area essentially employs up to three units with the seventh unit being used as required across both areas.
- Dyke extraction in the longwall blocks is scheduled post-development, and in advance of longwall mining. It involves the extraction of the hard igneous material and replacement with low strength concrete fill.
- The longwall schedule applies a single longwall unit in Appin Area 7 extracting panels sequentially from southeast to northwest. After the completion of West Cliff, longwall operations commence in Appin Area 9, also sequential mining panels from southeast to northwest.

Scheduling at BSO is based on a principle whereby unconstrained equipment productivity is modified using de-rating factors to establish a constrained productivity rate. De-rating factors are applied for depth of cover, proximity to faults and dykes, geotechnical layout factors and roadway type. The relative effect of each parameter on the overall constraining factor is based on experience at the site. Zones for the main de-rating factors (faults and dykes) are indicated on Figure 7-2.

Weekly development advance rates vary depending on the parameters outlined above, however they generally average approximately 120 m per unit/week (with a maximum of 180 m per unit/week). This rate is well within typical industry norms for similar conditions. Weekly longwall production varies according to a set of similar parameters as those used for development and averages (across both Area 7 and Area 9) approximately

60,000 t ROM per unit/week (with a maximum of 70,000 t ROM per unit/week). This figure is consistent with the total capacity of the outbye coal clearance systems. Forecast production at BSO compares well with historical rates.

RPM are of the opinion that the production rates used in the development of the schedule are both realistic and achievable especially given that the schedules are based on a series of panels that are of consistent length and similar geotechnical conditions and thus should provide extended periods of consistent production.

7.3 Dendrobium Mine

7.3.1 Mining Methods and Overview

Dendrobium Mine commenced operations in the Wongawilli Seam in 2002 to ensure continuity of supply of Wongawilli Seam coal after the closure and subsequent sale of Elouera Mine. Access to the mine workings is through an adit with the current operational areas approximately nine kilometres from the mine entrance.

Dendrobium Mine is currently operating Area 3B (Figure 7-6) consisting of ten longwall panels labelled sequentially from LW9 to LW18. As shown on Figure 7-6 the mine has previously extracted eight longwall panels from areas 1, 2 and 3A developing the mine from east to west.

A single longwall panel (LW19) remains in Area 3A and this will be extracted after the completion of Area 3B. This panel was found to be viable after recent exploration drilling better defined the boundaries of an igneous sill located between areas 2, 3A and 3B. The improved definition of this feature has also driven a change to the mine layout and the main headings in Area 3B, which were previously straight and have now been reoriented in a clockwise direction at LW15.

The remaining panels in Area 3B, with the addition of LW19 have been defined as Coal Reserves in the 2014 Competent Person Report and form the limits of assessment for the Dendrobium operation of the Illawarra Coal Reserves Valuation. Areas 3C and 4 located to the north of the current workings have been defined as Coal Resources in the 2014 Competent Person Report but certainty over their extraction has not yet reached a level to support their inclusion in the Coal Reserves.

The mine operates in an area that has been subjected to a considerable amount of igneous activity. Although igneous intrusions are typically problematic to longwall operations, the mine layout at Dendrobium has been designed to avoid the major sills and dykes and the remaining dykes that intersect planned longwall panels are not expected to represent a significant impediment to operational performance.

A large fault exists to the south of the last panel in the 3B series and a smaller structure migrates across the last three panels. Although it is judged by Illawarra Coal that the longwall will be able to mine through or in the case of LW18, adjacent to, these features, a de-rating factor has been allowed in the assessment to allow for reduced productivity.

RPM found that the technical viability for the extraction of longwall panels 10 to 19 is favourable and total mine output of up to 5 Mtpa ROM coal should be achievable in the anticipated conditions.

In recent years the mine has experienced roof failures in the entry road, the main headings and the longwall gateroads (as described in more detail under "Geotechnical Incidents" below), and these incidents have impacted on the productivity of the operation whilst remediation work was carried out. Measures have been put into place to reduce the risk of a recurrence of such events.

Historical mine performance has steadily increased since the mine commenced operation, from approximately 3.0 Mtpa to 4.5 Mtpa. Previous performance was hindered by the low number of longwall panels in each series, resulting in more development per longwall tonne and the ongoing establishment of longwall mining in virgin ground. The mine now has eight panels to extract within the same series and this will be an advantage for the operation, although the potential benefit may be tempered to some extent by deeper ground, more control measures to avoid strata failure and increasing travel distance within the operation.

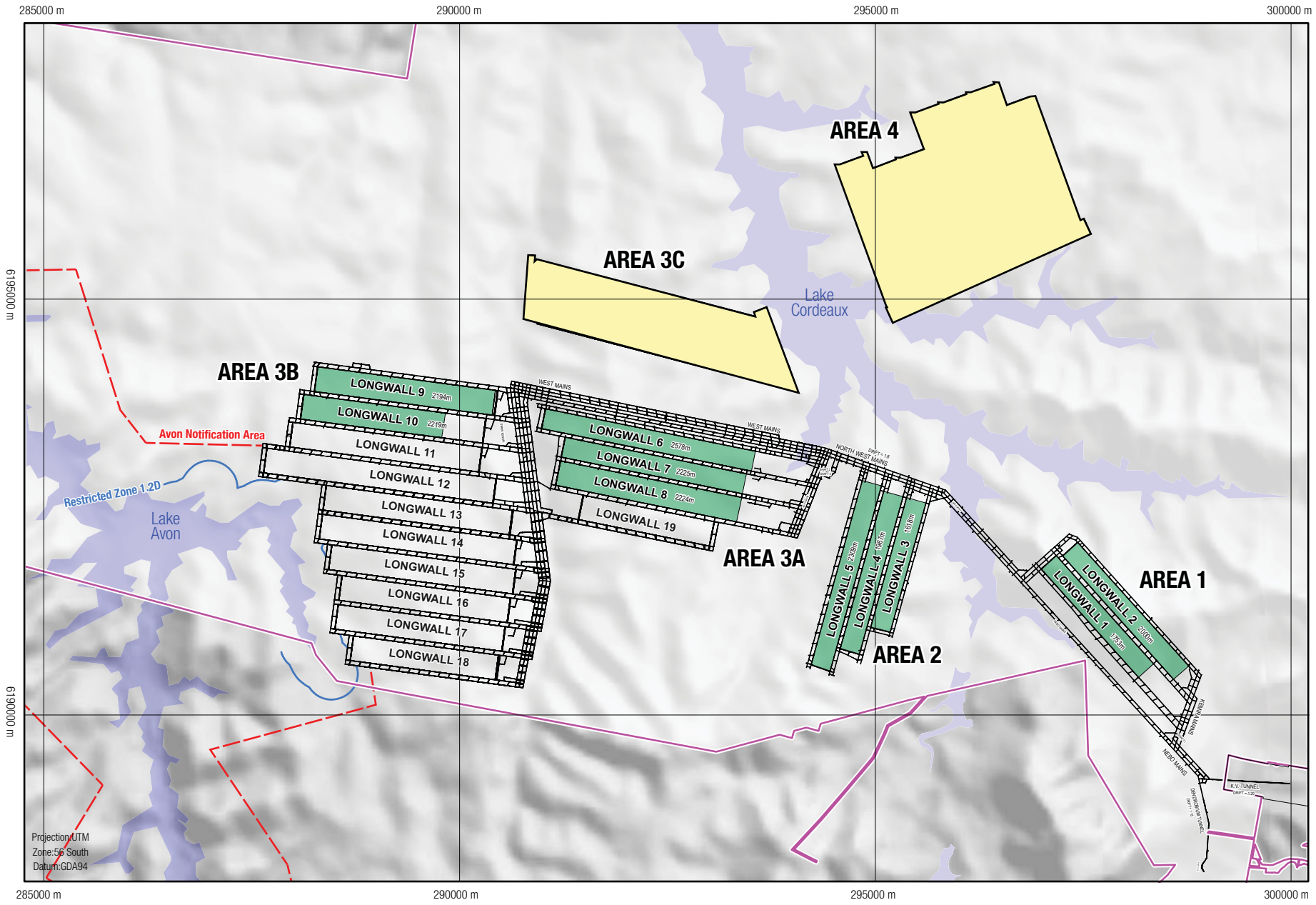

Projection: UTM
 Zone: 56 South
 Datum: GDA94

LEGEND	
	CCL768 boundary
	Mined Out Longwall Panels
	Lakes
	Avon Notification Area
	Restricted Zone 1.2D
	Potential Mine Extension Areas

0 5 km
 DO NOT SCALE THIS DRAWING - USE FIGURED DIMENSIONS ONLY. VERIFY ALL DIMENSIONS ON SITE.

CLIENT

resourcing the future

Illawarra Coal

PROJECT

NAME: **ILLAWARRA COAL - COMPETENT PERSONS REPORT**

DRAWING: **DENDROBIUM UNDERGROUND MINE LAYOUT**

FIGURE No. 7.6	PROJECT No. ADV-SY-04120	Date March 2015
-------------------	-----------------------------	--------------------

7.3.2 Geotechnical Factors

Figure 7-7 illustrates the geotechnical setting in which Dendrobium operates. The seam has been intruded by igneous material in the form of sills to the southeast and northwest of Area 3B and dykes to the north of areas 3A and 3B. A large fault (the Elouera Fault) lies to the south of Area 3B on the boundary with the Elouera Mine, and the Avon Dam, under which mining is not permitted, lies to the west.

Seam Dip

The Wongawilli Seam in Dendrobium Area 3B has a north plunging syncline with the axis across the longwall panels roughly one kilometre from the main headings. The majority of longwall mining in this area will be reasonably level with a shallow incline at the outbye ends of the panels. The modelled seam dips fall within the acceptable range for highly productive underground mechanised mining.

The 2014 Competent Person Report comments that LW5 in Area 2 mined through a seam dip of 7° with no discernible impact on productivity; seam dip of greater than 7° has not been identified in Area 3B.

Depth-related Stress

Mining at Dendrobium is currently being conducted at 350 m to 400 m below the surface, which in Australia is generally considered moderately deep and may be expected to present a low to moderately high stress environment.

Due to the cost and ease of establishing access to the working seam, longwall operations typically progress from their shallowest to deepest ground over time and experience increasingly challenging geotechnical environments. This is not the case for Dendrobium within Area 3B, as the depth of cover steadily reduces over the remaining eight longwall panels. Although there may not be a significant improvement in stress, it is reasonable to assume that depth-related stress over the series will be no worse than that currently experienced.

Faulting

The predominant fault associated with the Dendrobium operation is the Elouera Fault which lies to the south of Area 3B, on the boundary with Elouera Colliery. The fault is understood to be a complex zone of faulting with numerous individual fault planes, and a range of strike orientations with displacements ranging from 5 to 40 m. The main Elouera Fault continues in a north-westerly direction, diminishing in size as it crosses the outbye ends of longwall panels 16, 17 and 18 (Figure 7-8).

A second-order fault, splitting off from the main Elouera Fault in a WNW orientation lies to the south of LW18 and has a net throw ranging between 25 m and 40 m. A feature of this magnitude cannot practically be negotiated by longwall mining.

The three shaded zones on Figure 7-8 (Min Fault, Med Fault and Max Fault) indicate the severity of the faulting and their potential impact on mining. The blue, Min Fault, zone runs along the length of the maingate side of LW18 and cuts across the outbye ends of longwall panels 16, 17 and 18. The blue zone has been described as potentially having boggy zones and high stress, and longwall mining and development in this area will be difficult.

From the information provided it is assumed that the longwall will be capable of negotiating the Elouera Fault at the outbye ends of longwalls 16, 17 and 18 but at a reduced rate. Additional de-rating has been applied along the length of LW18 to allow for potential impacts from the proximity of the second order fault.

No other significant faulting has been identified within the Coal Reserve layout and although it is inevitable that minor faulting (less than 2 m) will be encountered, negotiation of these faults will be aided by the seam thickness which enables operations to temporarily mine out of the normal working horizon without having to encounter strata that will inhibit mining activity.

285000 m 290000 m 295000 m 300000 m

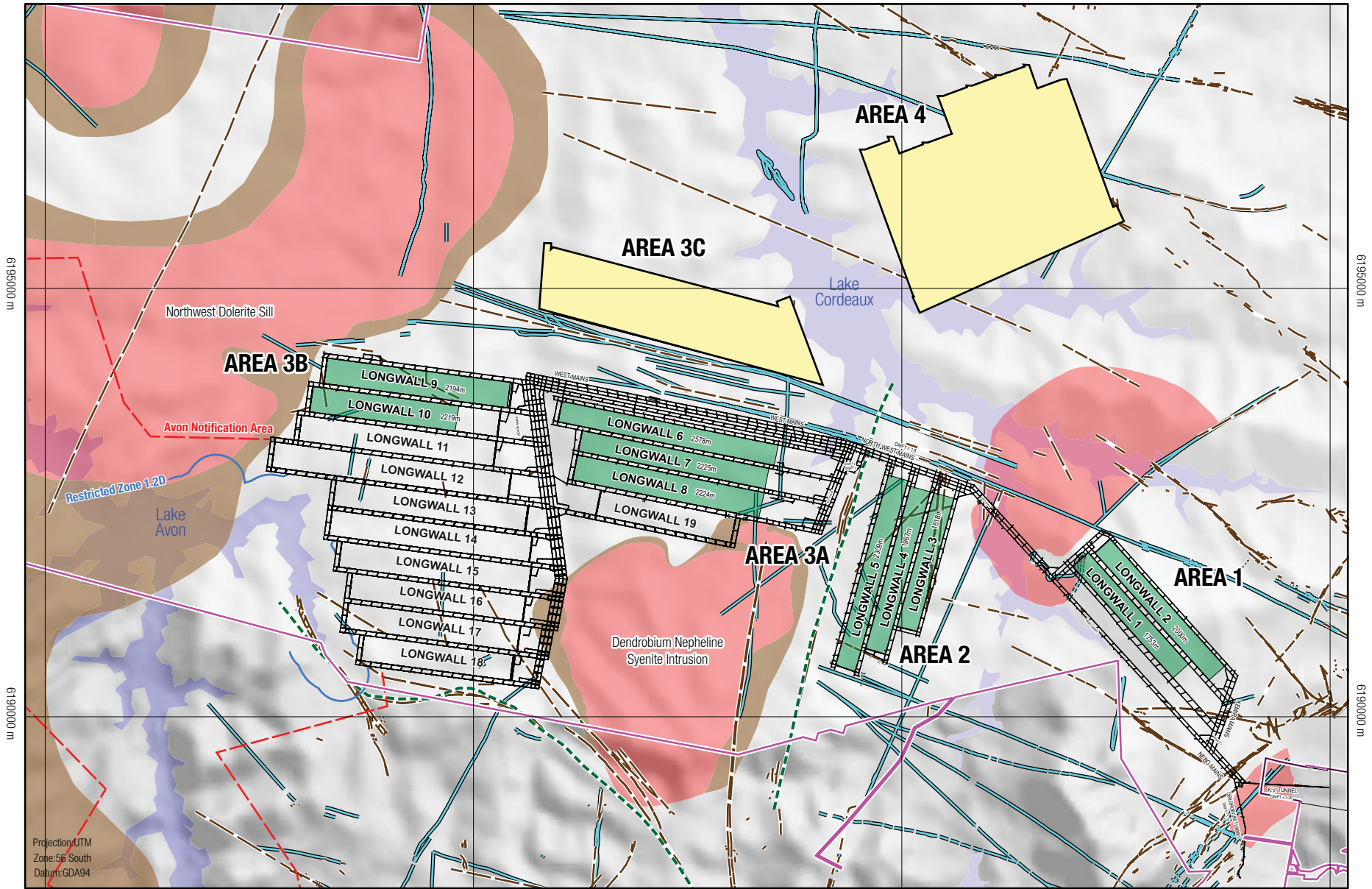

6195000

6190000

6195000

6190000

Projection: UTM
Zone: 56 South
Datum: GDA94

285000 m 290000 m 295000 m 300000 m

LEGEND

CCL768 boundary	Avon Notification Area	Interpreted Dykes
Mined Out Longwall Panels	Restricted Zone 1.2D	Sill affected WW Working Section
Lakes	Modelled Faults	Sill affected WW seam above Working Section
Interpreted Faults	Potential Mine Extension Areas	

0 5 km
DO NOT SCALE THIS DRAWING - USE FIGURED DIMENSIONS ONLY. VERIFY ALL DIMENSIONS ON SITE.

CLIENT

resourcing the future

Illawarra Coal

PROJECT

NAME: **ILLAWARRA COAL - COMPETENT PERSONS REPORT**

DRAWING: **DENDROBIUM UNDERGROUND MINE LAYOUT WITH GEOLOGICAL STRUCTURES**

FIGURE No. 7.7	PROJECT No. ADV-SY-04120	Date March 2015
-------------------	-----------------------------	--------------------

Figure 7-8 - Eloura Fault Disturbed Ground Boundaries

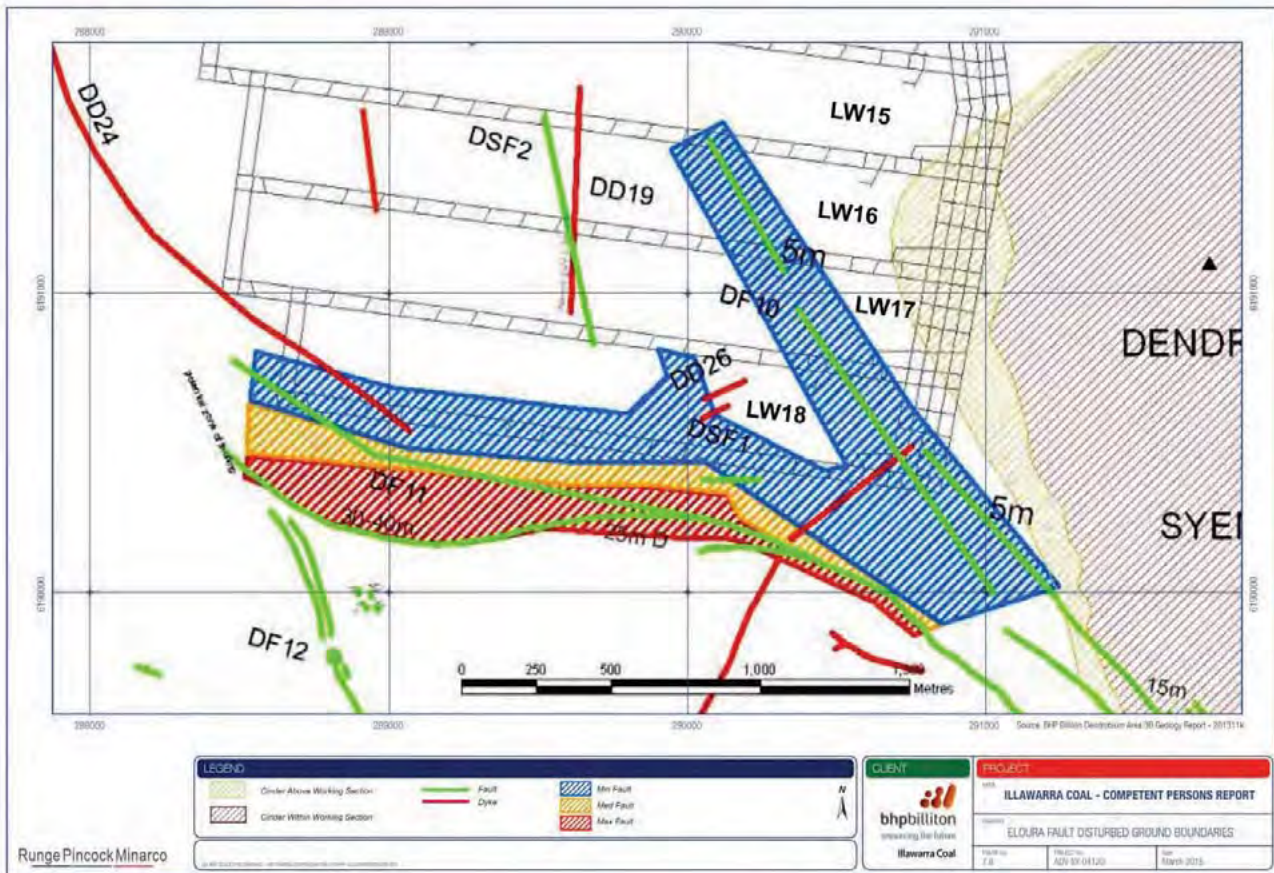

Igneous Intrusions

As discussed in **Section 7.2.2** igneous intrusions within the mining area may disrupt mining operations and must therefore be properly identified.

There are two significant sills in the vicinity of Dendrobium; the Dendrobium Nepheline Syenite Sill to the east of the Area 3B mains and the Northwest Dolerite Sill to the northwest of the Area 3B longwall panels. Understanding of the Syenite intrusion has improved through recent geological drilling which has allowed the inclusion of LW19 as an additional panel in the 3A area. This redefinition of the sill area has also required a redesign of the Area 3B mains to include a “dogleg” to avoid the intrusion at the southern end of the 3B series.

The redesign was subsequent to the 2014 Coal Reserve Statement and, as outlined in **Section 6**, RPM estimates a 6% reduction in ROM Coal Reserves is expected as a result of this change.

Dykes

Dykes at the mine are generally doleritic in composition and their size, distribution and effect on the Wongawilli Seam can be predicted with reasonable confidence based on local experience. Cinder of coal or other heating effects on either side of the dyke typically extend no further than the thickness of the dyke itself. The dykes cause localised roof instability but where they are thick, they may contain a hard unaltered core which can be an impediment to mine development.

The Dendrobium Dyke Zone to the north of Areas 3A and 3B contains numerous dyke branches and has to date formed a boundary to mining activity. The mine has been developed adjacent to this zone on the southern side. It may however, be possible to develop roadways through this zone to access resources to the north. Other dykes shown on the Area 3B mine plan have largely been projected from surface mapping and represent smaller, low confidence features, that are not expected to impact on longwall operations.

Mining Horizon

The working section, or mining horizon for Dendrobium, lies at the base of the Wongawilli Seam which is generally between 9 m and 10m thick. The working section utilised in Areas 1, 2 and 3A was selected on the basis of a working height that suited the equipment, the provision of stable floor and roof horizons, and exploitation of the most economically favourable portion of the sequence of coal plies.

The working section for the first three areas "The Standard Working Section" ranged between 3.20 m and 3.65 m in thickness, operating to stone bands at the roof and floor. The Standard Working Section expands in thickness to the west and in Area 3B it was greater than the operating range of the existing longwall equipment. In LW9, an alternative working section had to be selected but this was recently rectified on LW10 when a new set of supports with a larger operating range were delivered and commissioned at the operation.

Geotechnical Incidents

Between April 2012 and September 2014, Dendrobium experienced six major strata events, three of which were in the entry road or main headings and three in longwall gateroads.

The incidents in the main headings and access road involved failure of the roof and required the redeployment of resources to clear the fallen material and re-support the roof. The operation was able to confine the production impacts associated with these incidents to development, thereby limiting the loss of production in the short term.

Two incidents occurred in the maingate headings in 2013 and these directly impacted on the longwall for a total of eight weeks across the two incidents. The more significant of these two incidents resulted from convergence of the roof and floor to a point whereby the longwall could no longer pass. A section of conveyor belt had to be removed and the floor re-mined and the roof re-supported before longwall mining could continue. The delays associated with these strata incidents resulted in a reduction in longwall output in the order of 0.5 Mt in comparison to the previous year.

The final incident occurred in the tailgate of LW9 which is being used for ventilation purposes. Although this did not have a direct impact on longwall production, this is an important roadway in terms of the mine ventilation system and without suitable repair work, this had the potential to significantly affect the operation.

Subsequent to these incidents, there has been an increase in monitoring of roof convergence in the maingate to provide early warning of geotechnical issues that may impact on longwall performance. The operation now also allows additional time within the schedule to stop the longwall at specific points and re-mine the floor to overcome floor heave issues. It is clear that the mitigating measures implemented by Dendrobium will reduce the likelihood of similar incidents occurring in the future but it has not been possible to confirm the level of risk reduction going forward.

Higher stress concentrations are however, generally expected on the first longwall panel in previously unmined coal reserve areas, and consequently reduced productivity is usually expected in these panels. After the first panel, stress conditions are expected to improve, resulting in a more productive mining environment. The elevated output from LW10 appears to confirm this trend, although the application of new supports would have also been beneficial, by maintaining better control of the roof. The new supports are expected to be capable of managing the conditions expected for the remainder of Area 3B and for LW19.

7.3.3 Mine Gas Management

The Wongawilli Seam in Area 3B is generally characterised by low gas content, low permeability and a gas composition that is primarily methane. This provides an environment that can be managed solely by the mine's ventilation network and does not require additional gas management measures to be implemented. This has historically been the case for Dendrobium, which to date has not required the application of gas management systems.

A different domain does however appear to exist over the LW9 panel and the inbye ends of LW10, 11 and 12. This domain is illustrated on Figure 7-9 where the gas content increases from typically less than 2 cu.m/t, to between 2 cu.m/t and 4 cu.m/t. A corresponding increase in permeability appears to occur in the same area thus significantly elevating the anticipated gas emission rates. The third factor associated with this domain is a marked change in the gas composition from typically greater than 80% methane to as low as 38.5% methane.

Methane and carbon dioxide are the two main gases associated with coal seam gas and so a reduction in methane is matched by a similar increase in carbon dioxide.

Despite these domain changes the longwall has continued to operate in LW9 and LW10 without the need for intervention through gas drainage and it is anticipated that this will continue to be the case for the remainder of Area 3B.

Figure 7-9 – Wongawilli Gas Content and Composition

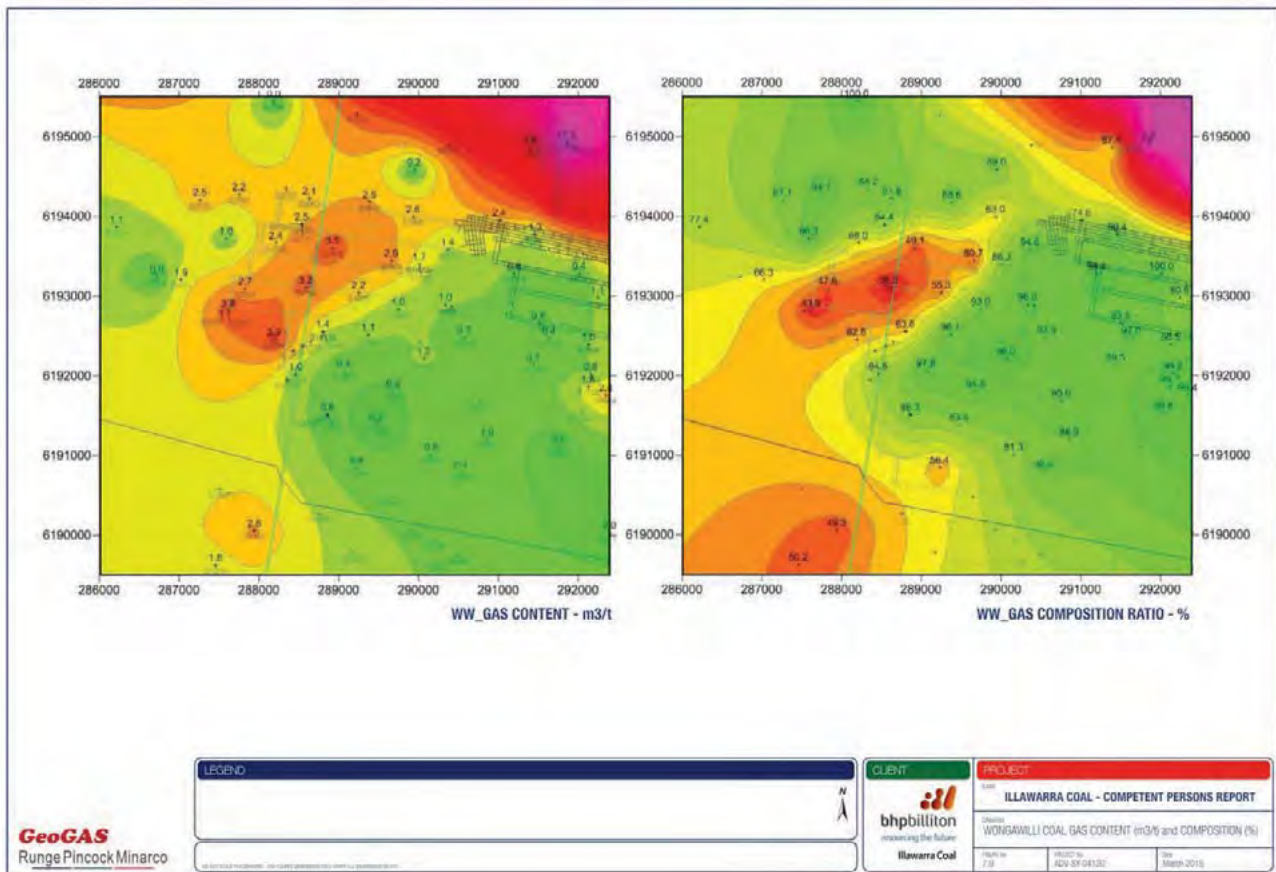

7.3.4 Mine Design and Operation

As discussed in **Section 7.3.2** and illustrated on Figure 7-7, Area 3B occupies a portion of ground located between igneous intrusions, the licence boundary and the Avon Dam. The Dendrobium Mine has been extended over nine kilometres from the surface entry point to the Area 3B main headings. Over this distance eight longwall panels have been extracted in three separate areas. The design of two or three longwall panels per area is sub-optimal from a longwall and a development perspective, but with the geological and surface constraints faced by the mine there was no opportunity to establish a more efficient design.

Area 3B extends approximately 3.6 km north to south and 2.7 km east to west, with the main headings extending from the north-eastern connection to Area 3A, in a southerly orientation along the eastern side of the block. The main headings consist of five roadways for the first four longwall panels before being reduced to four roadways. A re-orientation (dogleg) of the main headings has been designed at LW15 in order to avoid mining into the sill on the eastern side of the block. Longwall panels 300 m in width have been laid out in a similar orientation to the Area 3A panels. With ten panels located within Area 3B, this resource block provides the opportunity for more efficient mining performance than would have been possible in the past. Gateroads delineating the longwall blocks consist of two roadways and range from 3.1 km to 2.0 km in length. Continuous miners and shuttle cars are used to develop the gateroads. The layout for Area 3B is typical for an Australian longwall operation and is considered efficient with respect to both resource recovery and operational effectiveness.

Area 3C lies to the north of Area 3A and is separated from the existing operations by “The Dendrobium Dyke Zone”. Exploration data gathered to date shows that the resource on the northern side of the dyke zone has significantly higher gas content than previously mined areas and would most likely require pre-drainage prior to the commencement of mining activity in the area. At this stage the pre-drainage method and time to sufficiently drain to allow mining to commence has not been determined. For this reason Coal Resources have not been converted to a Coal Reserve in this area.

Area 4 lies to the northwest of Area 3C and represents a potential additional extension to the mine life. Coal Reserves have also not been defined over this area.

7.3.5 Mine Schedules

Longwall extraction is sequenced within Area 3B from north to south with a sole panel LW19 to be extracted from Area 3A following the completion of Area 3B. Development is conducted by two continuous miner units through to the end of 2017, after which a single unit is operated through to the end of 2021. The continuous miner sections operate independently to develop gateroads and typically achieve around 6 km per year, which is considered a sustainable average rate for this equipment and mine plan arrangement.

Historical performance has been used to consider the deliverability of the production output used in the valuation of the reserves. Longwall productivity has steadily increased as the mine has expanded, averaging 56,000 tpw in Area 1, 62,000 tpw in Area 2 and 74,000 tpw in Area 3A.

A mine schedule has been developed based on the performance achieved for LW10, whilst allowing for de-rating associated with major faulting. A reduction of 10% productivity has been applied to the last panel in the Area 3B series (LW18) and a 25% reduction in productivity where the longwall mines through the Elouera Fault at the outbye ends of the last three panels (LW16, 17 and 18).

The resulting mine output ranges from 4.5 Mt to 4.8 Mt. The average is 2.5% more than the mine’s highest output to date and peaks at 7% greater than this figure. RPM consider these increases are the result of the lack / removal of constraints historically experienced, as opposed to step improvements in operating efficiency. The changes in constraint are as follows:

- The mine layout, driven by geological conditions, is considered a primary cause of the lower production rates previously achieved by the mine. Longwall operations are designed to sequentially step from one panel to their adjacent panel and are most efficient when able to do this for an extended period. It is inevitable that longwalls will need to be relocated to new areas from time to time, but the increased activity associated with these moves carries with it additional cost, risk and potential production delays.
- Mines often experience lower productivity when moving to a new area while new installations and systems are established. The longwall operating method may need to be subtly modified when encountering new conditions, and there will be a learning period as crews and supervisors adapt to the changes.
- In addition, due to the presence of solid strata on either side of a panel in new ground, there may be increased stress and more challenging operating conditions. At Dendrobium, the first nine panels were mined across four different areas with three different panel orientations. It is likely that this would have had a detrimental impact on performance.

The production disruption in LW9, due to convergence in the maingate is typical of the kind of impact experienced by operations encountering a change to geological and geotechnical conditions when relocating to new areas. In contrast, LW10 has been highly productive and has not experienced any of the same issues as LW9.

RPM are of the opinion that the higher productivity for Dendrobium, applied to the valuation is both reasonable and achievable.

8 Equipment and Infrastructure

8.1 Bulli Seam Operation

Equipment and infrastructure at BSO reflects the history of the three separate operations which have become more integrated in recent years. The facilities and operations of the Tower mine have now been fully integrated with the Appin operation, whilst the integration of the West Cliff mine is ongoing.

The infrastructure is being interconnected where possible and the mining equipment is now being managed as a fleet across the two areas.

The BSO has sufficient development equipment to meet the current and future planned mining operations.

8.1.1 Equipment

Continuous Miners

The West Cliff operation has used two Sandvik MB610 and one Joy 12CM30 continuous miner bolters for development. With the last longwall block now being fully developed at West Cliff, efforts are being focused on the development of the West Cliff - Appin driveage. As a result, the Joy 12CM30 has been transferred to Appin, leaving the two Sandvik units working at West Cliff.

The Appin Mine has an increased development load with the need to establish mains at either end of the Area 7 panels, the new Area 9 series mains and the first of the 900 series panels. To cover this work, the mine has three Sandvik MB650, three Joy 12CM30 and one Joy 12CM12 continuous miner bolters. The Joy 12CM12 machine was acquired second hand from another operation in 2010 and is to be replaced with a Sandvik MB650 in November 2014. On completion of the connection to West Cliff an opportunity exists for some rationalisation of this fleet.

The integration of the two mines and the high level of commonality with the units in service at Dendrobium allows for a group wide approach to machine overhauls and replacements.

Shuttle Cars

Illawarra Coal has standardised with the Kopex Waratah 16 tonne capacity Waracar. These machines are locally produced in NSW offering a high level of parts and support. Eleven machines are in use across the two mines that make up the BSO.

The standardisation of the machines and the number in use allows for effective fleet management across the operations. The use of identical machines at Dendrobium further enhances this capability.

Feeder Breakers

Three feeder breakers are in use at West Cliff while the more complex development situation at Appin has eleven machines available. The machines are a mix of Stamler and Ontrak machines. The large number of machines in use will allow for effective rotation for overhaul and provide the ability to pre-install machines when establishing new development headings.

The machines in use are also similar to those in use at Dendrobium allowing for the management of the entire fleet across the two operations.

Auxiliary Fans

West Cliff has four 22 cu.m/s auxiliary fans in use, while Appin has five 18 cu.m/s and five 22 cu.m/s. The units are physically interchangeable between the different areas with the difference in capacity suiting the different ventilation requirements.

Longwall Equipment

The BSO have access to three complete sets of longwall equipment. Currently one set is installed in West Cliff panel 37, with another set to be installed into the last West Cliff panel, number 38. The third set is currently working in Appin Panel 706.

Shearer

All of the shearers used throughout the group are based on the same main body, a joy 7LS shearer. The differences between the shearers are minimal, allowing for effective rotation across the three faces at the BSO. Only minor changes are required to adapt this machine for Dendrobium. The group has access to four machines, allowing for the rotation of the spare machine through an overhaul program. This rotation and overhaul is managed by the group engineering personnel at the regional office.

Armoured Face Conveyor

The Bulli Seam operation has access to three of the five sets of AFC pans and drives to suit. Pans are re-installed to reduce longwall move durations. Pans have generally experienced low wear rates, and the ongoing rotation and overhaul is managed on a group basis. AFC drives are rotated through an overhaul scheme with spare equipment in use to allow for this to occur separate from the longwall moves. This reduces the time required for the longwall move and reduces the risk of unexpected delays in the event that major repairs are required. Commonality of this equipment across the group allows for this to be management on a fleet basis.

Supports

The BSO use three sets of roof supports across the different panels. The roof supports are being rotated through the different mining areas in an effort to match the equipment characteristics with the mining conditions.

Roof support set number 2 (PRS2) is currently in operation in Appin panel 706. On completion of this panel, the supports will be overhauled as required and moved to Appin Panel 901. As the mine progresses, these supports will be rotated between Appin 700 and 900 series panels.

Roof support set number 3 (PRS3) was originally sourced from a mine in Queensland for use at Dendrobium. While designed for a higher extraction height than is currently taken at West Cliff, these supports will work without difficulty at lower ranges. A detailed reliability improvement program has seen the number of hoses on these shields greatly reduced to reduce the number of delays experienced due to hose damage. These supports have now been fully overhauled and are to be installed into West Cliff Panel 38. Thereafter these supports will be moved to Appin Panel 902.

Roof support set number 4 (PRS4) is currently being used for the extraction of West Cliff panel 37. On completion of this panel, the supports will be overhauled and moved to Appin panel 707.

The rotation of equipment is planned in such a way that the Appin 900 series panels will have a full longwall pre-installed. This will limit the interruption required at each longwall move as the production crew changes from one panel to the next. A dedicated longwall move crew will then recover the completed panel's equipment and pre-install it on the new bock after necessary overhauls are completed.

Table 8-1 – Roof Support Moves

	Current Panel	Move 1	Move 2	Move 3
PRS2	Appin 706	Appin 901	Appin 708	Appin 904
PRS3	West Cliff 38	Appin 902	Appin 709	
PRS4	West Cliff 37	Appin 707	Appin 903	Appin 710

Source: Supplied by Illawarra Coal.

Maingate and Outbye Equipment

For each longwall installation a set of equipment is installed in the maingate and outbye consisting of:

- Beam Stage Loader;
- Crusher;
- Monorail;
- Distribution Control Box;
- Transformer;
- Control station;
- Hydraulic pump and tank, and,
- Shearer water pump.

As a group, this equipment has been standardised wherever possible to allow for rotation across the different longwall installations. Sufficient spares are available to allow for overhauls outside of longwall move times.

Coal Clearance

The BSO have a complex coal clearance arrangement that reflects the history of the original mines.

At West Cliff, development of all the longwall blocks has been completed, and only longwall production coal is being carried out from the active mining areas. The last block in the mine (Block 38) is orientated at right angles to the previous blocks and has been designed to load coal directly onto the mains belt. Development coal from the connection development to Appin is loaded onto the same system.

A series of three conveyors with capacities ranging from 2,500 to 3,500 tph will connect the Appin area to the West Cliff underground bin located at the winding shaft. This bin of 1,000 t capacity feeds into the shaft skip haulage rated at 750 tph which is the limiting component in the coal clearance arrangement. As a result, significant effort has been placed on ensuring the high reliability of the shaft and moderating the coal flow to ensure that the underground bin does not become overloaded and cause the conveyor system to shut down. A significant capital project is being run by the group engineering function to upgrade the West Cliff coal clearance system.

The coal clearance system at Appin is also a legacy of the mine history. The Tower Colliery coal hoisting shaft has been decommissioned, but is used as a downcast ventilation shaft and all of the winding equipment is still in place. Seven conveyors in series rated between 3,220 and 3,500 tph convey coal to the Appin pit top from the current Area 700 series blocks.

On completion of the link to West Cliff, the direction of mining in the Appin 700 series blocks will be reversed and this coal will be cleared via five belts to the existing West Cliff underground bin and shaft. Two additional conveyors will be required to facilitate the ongoing development of the 700 series blocks.

The Appin Area 9 longwall blocks are serviced by a series of conveyors that link into the Appin coal clearance system. At the moment these are handling only development coal and mine scheduling has been arranged so that longwall production from this area will commence only after the Appin 700 series blocks are being cleared through the West Cliff system. In this way, the two main production areas at Appin will each have their own coal clearance system.

8.1.2 Infrastructure

Power

Site Supply

The complex history of the BSO has led to a situation where the mine has a number of different supply points. These include:

- Douglas feed 11kV;
- Appin West Feed 6.6 kV, and
- Appin East feed 6.6 kV.

The ability to interconnect some areas of the mine exists to allow a measure of redundancy.

West Cliff operates on a separate circuit but will be integrated with Appin on completion of the connecting drive. This will further increase the redundancy in the system. The West Cliff supply consists of:

- No 2 Shaft 11kV;
- 11 c/t borehole 11 kV, and,
- 12 c/t borehole 11 kV.

Underground Distribution

Across the BSO, the underground workings are fitted with the expected array of cables, switchboards, transformers and distribution control boxes. The great extent of the historical workings has increased the need to maintain power in a number of different areas. Some simplification will be possible when the mining operations cease at West Cliff.

Backup Supplies

As the operation is located in a populated area, it has access to the state electricity grid and experiences a high level of power supply reliability. Backup generators / UPS are available for key equipment in the control and monitoring system, but not for ventilation or production machines. As a result of this, and the high levels of water and gas in the mine, a power failure of more than one hour can lead to significant power delays as areas are degassed and dewatered prior to re-establishment of local supply.

Gas Powered Generation

Gas drained from the mine is used for the generation of electricity by third parties. This power is fed directly to the grid. The co-location of these generating facilities make it possible for them to act as large capacity emergency power supplies. The online nature of the units would result in short switch over times. Consideration should be given to establishing a physical and contractual arrangement that allows the mine priority access to this locally generated power as a backup power supply.

Water Supply

Treated water from Sydney Water is supplied to the West Cliff, Appin East and Appin West pit top areas. This is used for surface amenities and underground for firefighting, dust suppression and motor cooling along with other miscellaneous uses. High pressure water treated is supplied to the longwall for hydraulic fluid.

Mine water is recycled through old workings as a filter and sediment trap before reuse as general water underground. Mine water brought to the surface is treated and then redirected with the Sydney Water supply for underground use.

The complex nature of the historic underground workings has resulted in a complicated water management system. Interconnections are in place between Appin East and West to provide redundancy of supply.

West Cliff is currently operated on a separate system to Appin whereby the Sydney Water supply is used in conjunction with recycled mine water. On completion of the connection drive to Appin, a further linkage will be made into that system. The end of mining operations at West Cliff will allow for simplification of the water supply at that site.

Dewatering

Appin has a complex mine dewatering system that collects water from operating areas, gas drainage and old workings. A high level of interconnection exists within the system to maximise flexibility. Old goaf areas are used for sediment trapping, filtration and storage until pumped to the surface where it is treated for re-use or discharge. Appin moves a significant amount of water and reliability of the dewatering system is required to be high.

West Cliff operates a relatively simple dewatering system that collects water in the old mining areas before it is pumped to the surface or reused underground. Water from these areas and the working areas of the mine are collected at pit bottom for pumping to the surface. Surface settlement dams are used for solids separation before the mine water is redirected for use in the coal handling plant.

Gas Drainage

The drainage infrastructure consists of a series of boreholes drilled to a depth of approximately 500 m through which methane gas is drained via a surface pipeline reticulation system connected to a gas extraction plant. After being extracted by the surface plant, the majority of the methane gas is directed, via an underground connection, to the EDL Power Station, where it is used to generate electricity. When the borehole gas flows exceed the capacity of the extraction plant and associated existing management infrastructure, and/or during plant breakdown/maintenance periods, the excess gas is flared via onsite flaring units. In an emergency, gas may be vented to the atmosphere. Depending on the quality and volume of gas extracted, it may be possible to reticulate gas to other users.

When operating, all boreholes have gas flow metering and control systems in place at the well head.

To support this extensive gas management plan, the mine is equipped with drill rigs, extraction pumps and all the necessary underground monitoring and control systems.

Communications & Monitoring

The BSO have extensive communications and monitoring systems that consist of ;

- Fixed telephone systems;
- Public address / warning systems (DAC);
- Two way radio systems;
- Fixed gas monitoring;
- Environmental monitoring;
- Equipment monitoring, and,
- Personnel tagging systems.

The system for Appin is fully integrated and available to control rooms at Appin East and West via both a dedicated SCADA system and PC access. West Cliff operate similar systems, but these are not interconnected with Appin. Direct telephone connections between the two mines are in place.

Road

Road access to both sites is good, with the road system capable of handling all trucking for raw coal delivery to the coal preparation plant, and product coal delivery to either the BlueScope steelworks or the Port Kembla Coal Terminal.

Access for delivery of equipment and materials to site is excellent. The distributed surface facilities are accessed via a network of public roads that in generally in good condition, with alternate access routes available to most sites.

Rail

There is no rail link to the BSO.

Surface works

Ventilation

Multiple ventilation shafts, both upcast and downcast exist across the BSO reflecting the amalgamation of the three historic operations. Some of these are co-located with pit top facilities, while some are remotely accessed. The ventilation shafts are in good condition and fitted with sufficient fans to ventilate the mine.

A new shaft for Appin Area 9 is under construction. New shafts are planned for the mine as the production areas expand. Suitable capital has been allocated for these. Underground booster fans are available at West Cliff to assist with mine ventilation.

Haulage Shafts / Drifts

Appin West is accessed via the Tower Mine haulage men and materials shaft. The Tower mine coal haulage shaft is no longer used, but the winding equipment and headframe are still in place.

Appin East is accessed via a slope haulage rail system. The mine has sufficient rail cars for the effective movement of personnel and materials to and from the surface.

West Cliff uses No 2 shaft for the haulage of coal to the surface. The auxiliary shaft for personnel transport is in place, but decommissioned. Drift access to West Cliff is via a slope haulage rail system and the mine has sufficient rail cars for the effective movement of personnel and materials to and from the surface.

Surface Buildings

Workshop, warehouses, offices and amenities exist at the Appin East, Appin West and West Cliff pit top areas. Appin West surface facilities are accessed only via shaft or public road, somewhat limiting their use. All of the facilities are comprehensively fitted and maintained in good condition. Sufficient working room exists at all three locations for effective operation of the men.

8.2 Dendrobium Mine

8.2.1 Equipment

Continuous Miners

Dendrobium uses three Joy 12CM30 continuous miner bolters for development. Two are fitted with plough type loading systems to reduce the unsupported area during operations, while the other is fitted with a centrifugal loading arm. The equipment record for the mine shows a fourth unit that has now been decommissioned.

Commonality between the machines at Dendrobium and those in use by the Bulli Seam Operation will allow for effective fleet management across all of Illawarra Coal.

Shuttle Cars

A total of five 16 tonne Kopex Waratah "Waracar" shuttle cars are in use at the mine. All machines are of the same make and model, and also match the machines in use at the BSO. Management of overhauls and replacements is undertaken on a fleet basis across Illawarra Coal.

Feeder Breakers

Two Stamler feeder breakers are in use at the mine. With the use of three continuous miners for development, this will result in at least one development heading loading directly onto the conveyor belt. Dendrobium also uses the continuous miners for "brushing" type operations to counteract floor heave issues. In either primary

development, or clean-up operations, the lack of a feeder breaker may result in slower development cycles through longer shuttle car discharge times. There is some risk that flat slabs of shale material may be loaded onto the coal clearance system and pose a risk of system blockages or damage outbye.

The machines in use are similar to those in use at the BSO allowing for fleet management across Illawarra Coal. An opportunity exists to transfer a machine from the BSO to Dendrobium to reduce the risks associated with loading onto the coal clearance system without the use of a feeder breaker.

Auxiliary Fans

Dendrobium has access to four auxiliary fans, two rated at 18 cu.m/s and two rated at 22 cu.m/s. This is sufficient to operate the mine and allow for some flexibility.

Longwall Equipment

The higher seam at Dendrobium results in equipment that has been optimised for this cutting height and rotation of equipment between Dendrobium and the Bulli Seam Operations is limited to those common parts, but excludes the movement of roof supports.

Shearer

The shearer at Dendrobium is based on the same machine as used at Appin and West Cliff. To accommodate the greater cutting height, the machine is modified to be sigma riding instead of toe riding, and is fitted with different down drives. This is a relatively simple operation and allows for management of the shearer fleet across the group.

Armoured Face Conveyor

Dendrobium has access to two of the five sets of AFC pans and drives. Pans are re-installed to reduce longwall move durations. Pans have generally experienced low wear rates, and the ongoing rotation and overhaul is managed on a group basis. AFC drives are rotated through an overhaul scheme with spare equipment in use to allow for this to occur separate from the longwall moves. Such a situation reduces the time required for the longwall move and reduces the risk of unexpected delays in the event that major repairs are required. Commonality of this equipment across the group allows for this to be management on a fleet basis.

Supports

The greater cutting height at Dendrobium has resulted in a dedicated set of roof support (PRS1) being installed from Block 9 in late 2012. This set is then relocated from block to block during each longwall move. Spare shields are available to allow for major maintenance, and necessary repairs are carried out during the move. Unlike the BSO, Dendrobium does not have access to a full spare set of shields, and as a result will incur longer production interruptions as the mining moves between blocks.

Table 8-2 – Roof Support Moves

	Current Panel	Move 1	Move 2	Move 3
PRS1	Dendrobium 10	Dendrobium 11	Dendrobium 12	Dendrobium 13

Source: Supplied by Illawarra Coal.

Maingate and Outbye Equipment

For each longwall installation a set of equipment is installed in the maingate and outbye consisting of:

- Beam Stage Loader;
- Crusher;
- Monorail;
- Distribution Control Box;
- Transformer;

- Control station;
- Hydraulic pump and tank, and,
- Shearer water pump.

As a group, this equipment has been standardised wherever possible to allow for rotation across the different longwall installations. Sufficient spares are available to allow for overhauls outside of longwall move times.

Coal Clearance

In comparison with the BSO, Dendrobium has a relatively simple coal clearance system. A series of belts from each development and production section deliver coal to four mains belts in series. These convey the coal via the “Kemira” drift to the Kemira Valley coal stockpile for onwards transport via rail to the coal processing plant. The conveyors are rated at 3,500 to 4,000 tph which is sufficient to meet the needs of the mine.

8.2.2 Infrastructure

Power

Site Supply

The main Dendrobium power supply from the grid is via the Kemira valley facility where a twin 33 kV feed is routed via a surface switchyard to twin 6.6 kV underground feeds. The switching arrangement allow for a high degree of redundancy. The offices, workshops and other facilities at the Dendrobium are fed via a line from this switchyard.

Underground Distribution

The underground workings are fitted with the expected array of cables, switchboards, transformers and distribution control boxes. The relatively compact area of operations has resulted in a simple system that is easy to manage. While the mine requires a significant water pumping system, the absence of high levels of gas simplifies the electrical layout.

Backup Supplies

The Dendrobium mine has a connection to the local grid and generally experiences a high level of power supply reliability. This is supported by a direct connection to BlueScope Steel’s electrical distribution system. As a result, backup power supplies are limited to UPS and small capacity generators to support critical monitoring and control systems.

Water Supply

Dendrobium is connected to the local domestic / industrial water supply for access to treated water and as a result does not need to treat this incoming feed. This treated water supply is used mainly for pit top facilities and as a feed to the longwall hydraulic system. A backup connection is available so that the rest of the mine can draw on this feed if required. A significant water recycling system is in place with grey water from the pit top area recycled for use underground. Sewerage water is disposed through the Sydney Water sewerage system.

Water from the underground working is recycled through the old Nebo and Kemira workings as a filtration and sediment trap. Following treatment, this water is then used in underground areas with the exception of longwall hydraulics. This feed is also used for general service water at the Kemira Valley coal handling facilities.

Dewatering

Local dewatering at Dendrobium is undertaken with a variety of pumps that deliver water to underground fish tanks. Mine water is then pumped in the old workings of the Nebo and Kemira mines. This effectively filters the water for re-use. Water drawn from these old workings that is not reused is discharged through a licensed discharge point. In the event of heavy rainfall, an overflow discharge point exists for the pit top sedimentation dams.

Communications & Monitoring

The Dendrobium mine has extensive communications and monitoring systems that consist of:

- Fixed telephone systems;
- Public address / warning systems (DAC);
- Two way radio systems;
- Fixed gas monitoring;
- Environmental monitoring;
- Equipment monitoring, and,
- Personnel tagging systems.

The system is fully integrated and available to control rooms at the pit top, Kemira Valley coal handling facility and via PC at the Dendrobium Coal Preparation plant. The mine has a dedicated SCADA system with PC access. Direct telephone connections between the mine and the CHPP are in place.

Road

Road access to the pit top area is via public roads with some limitations on capacity and access to meet community expectations. This requires planning, but does not interfere with operations. Road access to the Kemira Valley coal handling facilities is good. Some of the distributed mine infrastructure is located on land controlled by the Sydney Catchment Authority. Access to these areas is controlled, and must be planned with permission sought in advance. While this requires careful planning and co-ordination, to date it has not caused any major issues for operations.

Rail

A rail line links the Kemira Valley coal handling facilities with the Dendrobium Coal Handling and Processing Plant which is co-located with the BlueScope Steelworks at Port Kembla. The line is owned in part by Illawarra Coal with maintenance and operations undertaken by contractors. Operating restrictions exist for both the hours of rail use and the total volume of material that can be moved on an annual basis. The line is relatively steep and tight, with rail speeds being low. The line capacity is sufficient to meet the planned production over the life of the mine.

8.2.3 Surface Works

Shafts / Drifts

Dendrobium does not use a rope haulage system in a shaft or drift for the transport of personnel and materials.

Access to the mine is via the Dendrobium pit top along the Nebo Mains, or via the Kemira Valley site along the Kemira Mains and the Nebo mains. Some problems have been experienced with roof stability in the Nebo mains that have affected access, and remedial action has been taken to address this.

Surface Buildings

The Dendrobium pit top area was developed on the existing Nebo mine facilities. The pit top area contains all of the necessary workshops, warehouses, offices and amenities required for the mine. Located on the side of a steep hill, the pit top area is relatively small for a mine of this size. Careful management of the pit top area and the use of off-site storage is necessary to maintain efficient operations.

The Kemira Valley site is well laid out with facilities to operate and maintain the coal handling facility. This area is not used for general mine operations support. A large (140,000 t) stockpile has been built with underneath loading of trains. There are surface facilities for the maintenance and operation of this stockpile, and a number of redundant buildings on site.

9 Processing and Logistics

Illawarra Coal produces coking and energy coal products for the domestic and export markets. Bulli Seam coal is processed at the West Cliff Processing Plant and predominantly generates a coking product with a limited amount of energy coal. Wongawilli Seam Coal is processed at the Dendrobium Plant and typically 60% of the product is coking coal with the remaining 40% energy coal.

The Illawarra Blend is created by blending the Bulli and Wongawilli coking products. Any feeder coking product that has not been blended is sold on the export market as a straight Bulli or Wongawilli coal product.

The current Dendrobium Coal Reserves are forecast to be exhausted in FY2023, at which time Illawarra Coal will only produce Bulli Seam Coal. Illawarra Coal typically produces 1.5 Mtpa of energy coal and at the completion of Dendrobium will reduce to 200 ktpa of energy coal.

The projected and historical production by plant and product is provided in Table 9-1

Table 9-1 - Plant Production

Plant Production		Actual			Forecast									
		FY12(A)	FY13(A)	FY14(A)	FY15 (F02)	FY16	FY17	FY18	FY19	FY20- FY24	FY25- FY29	FY30- FY34	FY35- FY39	FY40- FY42
Coking Coal														
WCCPP	Mt (prod)	4.3	4.2	4.1	5.3	5.5	5.3	6.4	5.5	30.1	29.5	26.0	14.0	5.8
DCCPP	Mt (prod)	2.4	2.4	1.9	2.1	2.1	2.1	2.0	1.9	8.8				
Total	Mt (prod)	6.6	6.7	6.0	7.4	7.6	7.4	8.4	7.4	38.9	29.5	26.0	14.0	5.8
Energy Coal														
WCCPP	Mt (prod)	0.2	0.1	0.2	0.2	0.2	0.0	0.1	0.1	0.4	0.7	0.8	0.2	0.3
DCCPP	Mt (prod)	1.1	1.2	1.4	1.6	1.5	1.4	1.5	1.4	5.9				
Total	Mt (prod)	1.3	1.3	1.5	1.8	1.7	1.4	1.5	1.5	6.2	0.7	0.8	0.2	0.3
Total Product	Mt (prod)	7.9	7.9	7.5	9.2	9.3	8.9	10.0	9.0	45.1	30.2	26.8	14.1	6.1

Source: RPM estimate based on information supplied by Illawarra Coal.

Table 9-2 details coking and energy coal yields for each operation over the life of asset. The average coking yield is currently around 61% with Dendrobium yield at 43%, West Cliff at 65% and Appin Area 7 at 80%. The average steadily climbs over the next eight years as firstly West Cliff coal is replaced by Appin Area 9 coal which is around 84% and Dendrobium yield increases marginally as it mines into higher yielding resources.

After 2023 when the Dendrobium coal no longer contributes to the production profile the yield remains relatively stable but exhibits a slow decline as the projected yield in Area 7 declines as operations progress to the north. It is notable that the Area 7 energy coal yield increases in response to the reduction in coking yield.

Table 9-2 - Life of Asset Yield Profile*

Yield	Actual			Forecast									
	FY12(A)	FY13(A)	FY14(A)	FY15	FY16	FY17	FY18	FY19	FY20- FY24	FY25- FY29	FY30- FY34	FY35- FY39	FY40- FY42
Coking Yield													
WCCPP	70%	72%	68%	74%	79%	84%	84%	82%	84%	82%	81%	80%	74%
DCCPP	55%	53%	48%	43%	43%	44%	42%	42%	46%				
Average Coking Yield	63%	64%	60%	61%	64%	67%	68%	66%	71%	82%	81%	80%	74%
Thermal Yield													
WCCPP	4%	1%	3%	3%	2%	1%	1%	2%	1%	2%	2%	1%	4%
DCCPP	55%	53%	48%	32%	31%	29%	31%	32%	31%				
Average Thermal Yield	13%	12%	15%	15%	14%	13%	12%	14%	11%	2%	2%	1%	4%
Average Total Yield	76%	76%	76%	76%	79%	80%	81%	80%	83%	84%	84%	81%	82%

Source: RPM estimate based on information supplied by Illawarra Coal.

*Note: The yields shown on Table 9-2 are drawn from the geological model and present a realistic view of the expected yield from ROM feeds to the processing plants. It should be noted that "non-reserve material" (from Inferred Resources) is included in the mined output but treated as waste and not fed into the processing plants. The product tonnes can therefore not be replicated by multiplying ROM tonnages reported within this report by the yields presented in the table above.

9.1 Processing

9.1.1 West Cliff CHPP

The West Cliff CHPP handles all of the coal for the BSO. The plant uses a combination of crushers, screens and dense media cyclones to treat the raw coal. The product is dewatered by centrifuge, while tailings are processed in a spiral classifier before being dewatered in a filter press.

The CHPP has been upgraded and is currently in excellent condition. Access to equipment is good, and the plant is being maintained to a high standard. Reliability and operating times are good.

The current nominal capacity of the West Cliff CHPP is 1,200 tph following the completion of the upgrade project in December 2011. During the last year (up to 30th June 2014) the plant processed 5.9 Mt. The current installed capacity is considered to be adequate to meet the maximum throughput required in the life of mine plan of 8.1Mtpa

The upgrade project involved:

- Replacement of the existing fines recovery circuit (flotation);
- Increased capacity of the existing dense medium cyclone circuit;
- Increased capacity of the existing tailings and coal fines filtration system;
- Replacement of the existing coarse coal circuit (Baum jig) with a new Dense Medium Drum;
- Increased capacity of the existing materials handling system;
- Upgrade of the existing plant control system, and,
- Integrating the new automation system for additional process elements introduced as part of the project;

The expanded capacity is reflected in the nominal production rates in the current mine schedules for the BSO operations.

A major factor in processing the Bulli Seam is the removal of diluting material. The insitu coal is generally low ash but due to the nature of the roof and floor, significant quantities of diluting material can be present in the feed.

The CHPP is configured to produce two separate products a Bulli coking coal and a thermal coal that is blended with the Dendrobium coal preparation plant thermal coal to produce the Illawarra Blend 5600 energy coal.

The coarse (+50 mm) material is processed through a single dense medium drum which is sized to accommodate the fluctuations in the quantity of diluting material and to produce a single coking coal product. The -50 mm +0.5 mm material undergoes two stages of processing through dense medium cyclones with the first stage producing the coking product and the sinks material from the first stage either being discarded or processed again through a second dense medium cyclone to produce a thermal product. The fine (-0.5 mm) material is all processed through a flotation circuit to produce a coking coal product.

The flow sheet for the CHPP is shown in Figure 9-1.

Figure 9-1 – West Cliff Coal Processing Flow Sheet

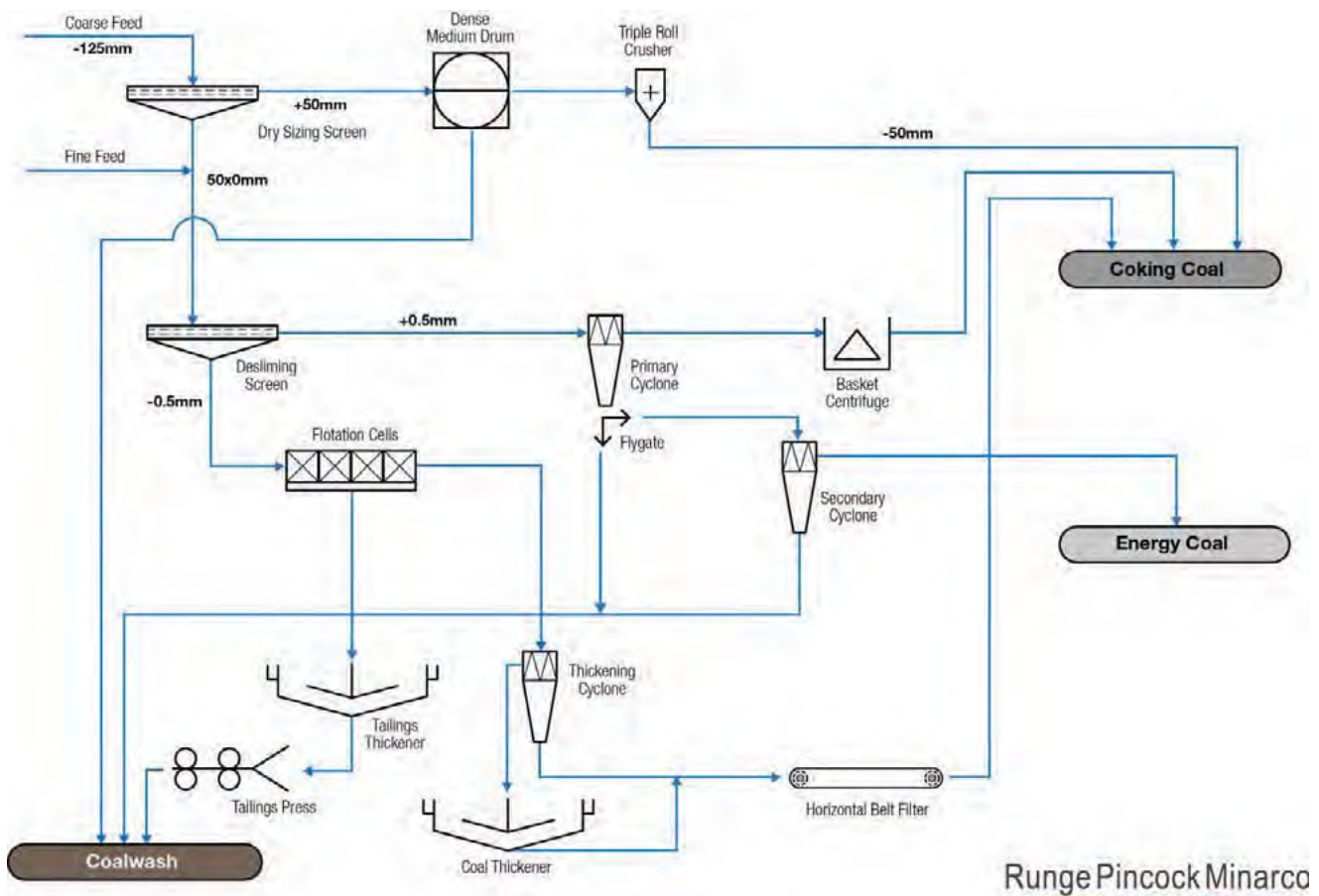

Runge Pincock Minarco

The installed equipment is considered to be both appropriate for the processing of the feed material and sized correctly to accommodate the anticipated product yields.

9.1.2 Dendrobium CHPP

The Dendrobium Coal Handling and Processing Plant is an older facility that was originally built as a part of the integrated steelworks to treat coal from a number of different mines. On the divestment of the steelworks by BHP Billiton to BlueScope, a lease of this facility was arranged. The plant is contained within the boundary of the steelworks on a relatively small, narrow footprint.

The plant is of an older design that has been upgraded many times in its life. Some redundant facilities still exist, and services (power, water, air) are supplied by the steelworks. The plant uses a series of screens, dense media cyclones and drum classifiers to treat the coal. Product coal is dewatered by centrifuge and tailings are dewatered by a belt filter.

Despite its age and limited space, the plant attains high levels of availability and reliability. While labour levels are low, the skill and experience of the workforce is high. The location of the plant in the heart of the industrial facilities of the city allows for fast and effective access to outside services when required.

The Dendrobium CHPP has a feed capacity of 720 tph. The basic configuration of the plant is shown in Figure 9-2 and is designed to produce two separate products; a Wongawilli coking coal and an energy product. The plant sits entirely within the footprint of the BlueScope steel works which limits the stockpiling space and prohibits the disposal of the preparation plant coal waste on site.

Figure 9-2 - Dendrobium Coal Handling and Processing Plant Flow Sheet

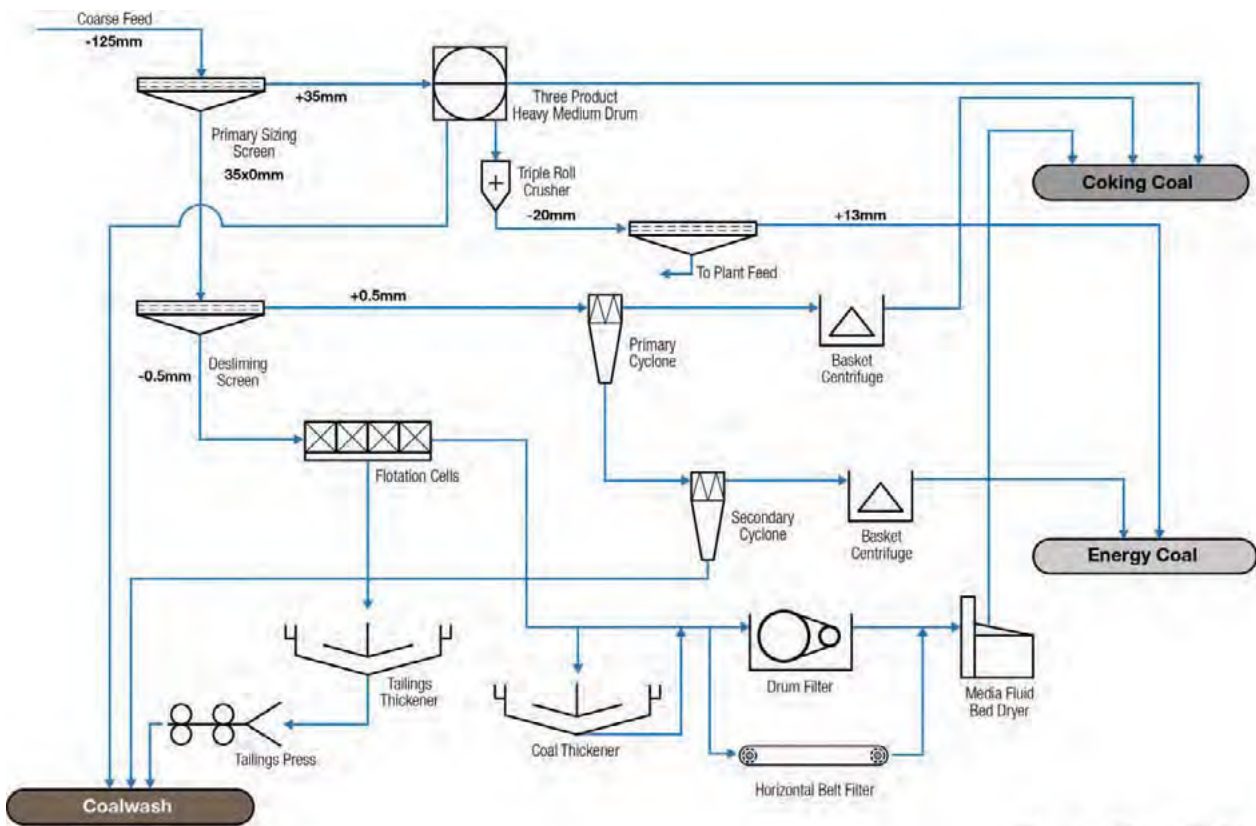

Runge Pincock Minarco

The current installed plant capacity should be sufficient to meet the maximum requirement of 5.1 Mtpa as specified in the life of mine plan. Due to a lack of ROM supply from the mine the plant's ability to maintain a throughput at this rate has not been demonstrated for a prolonged period to date although on occasions weekly average throughputs have matched or exceeded this rate. During the 2014 Financial Year the plant processed 4.0 Mt.

The rate of coal processing can fluctuate due to the variations in material size distribution delivered from the mine due to segregation of the coal as it is stockpiled at Kemira Valley. This can result in batches of coal arriving with disproportionately high percentage of course material which may necessitate the feed rate being slowed for short periods of time to avoid overloading of the drum. The ROM material also contains an unusually high portion of fines material but this is handled with the currently installed generous filter capacity in the plant.

Railing is not permitted between 11 pm and 6 am resulting in logistical considerations and a requirement to stockpile sufficient ROM material during the day to provide feed for the plant overnight. The 3,000 t live capacity in the raw coal bins is insufficient to maintain plant throughput overnight, therefore consistent continuous overnight production relies on reclaiming ROM material from the ground stockpile adjacent to the plant.

At current production rates this does not result in operational delays and would be manageable at the higher throughput identified in the life of mine plan with the use of additional reclaim machinery. This may however result in a slight increase in the raw material handling costs.

9.2 Logistics

9.2.1 West Cliff CHPP

The operation of the West Cliff CPP is heavily reliant on road transportation of both raw and product coal, approximately half the ROM feed is delivered by road from the Appin Shaft. This ROM material can either be

fed directly into the plant or stockpiled until required. There is sufficient available stockpile space for the size of the operation.

Figure 9-3 - Surface Transport Logistics

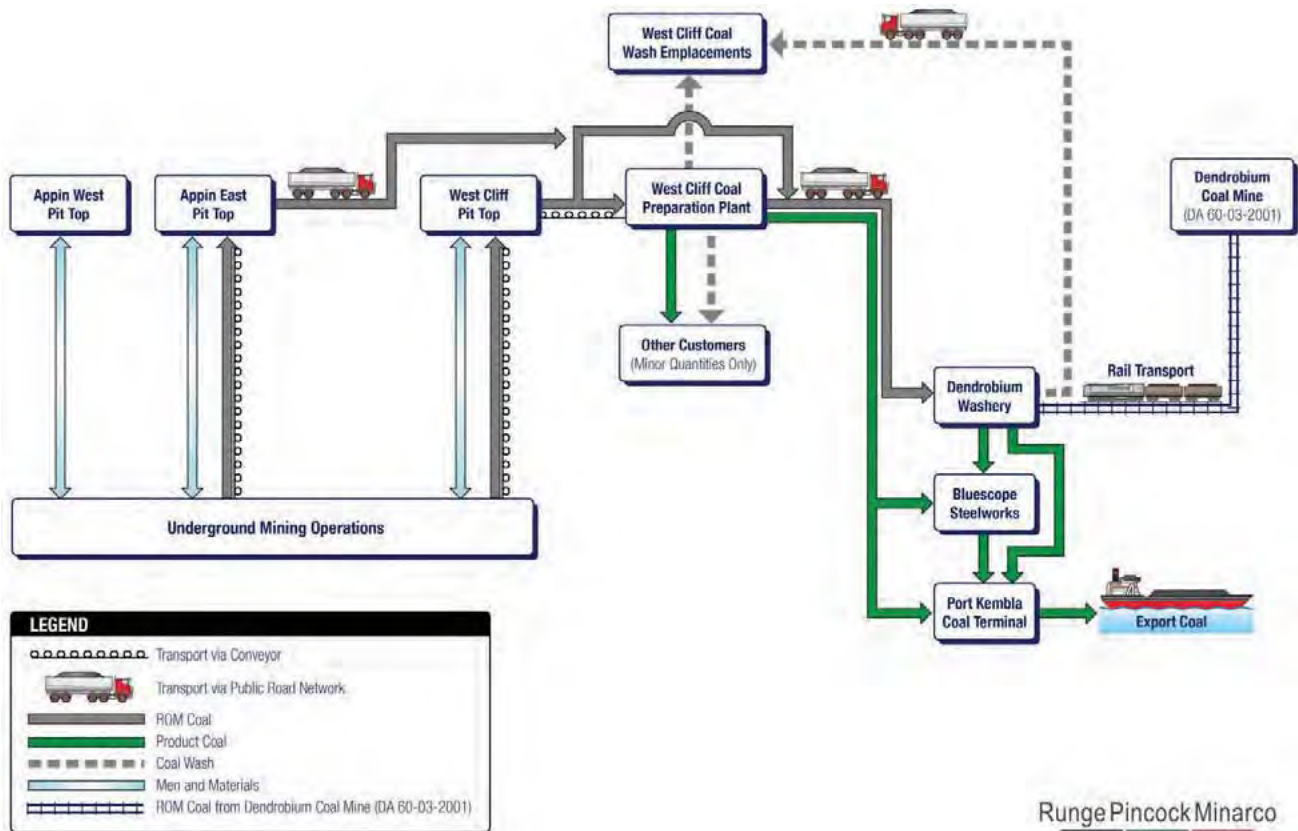

The ROM material exiting the West Cliff mine is fed either directly into the plant or onto the ROM stockpile. Both coking and thermal product coal from the CHPP are transported by road to PKCT and BlueScope steel works.

Discard material from the CHPP is hauled by truck from the plant to the on-site discard placement facility at West Cliff. While the haulage of discard material takes place entirely on the mine site, the haulage of ROM material from Appin East and product coal is via the public road network. The haulage of product material to PKCT and BlueScope is a journey of approximately 40 km descending the steep escarpment and travelling through the town of Wollongong.

The interaction of the bulk material transportation on the public road network is actively managed with respect to health and safety and community concerns. As outlined in **Section 10**, there have been some community complaints to Illawarra Coal associated with the trucking activity, and this issue is being actively managed by Illawarra Coal.

There are several haulage contracts in place with different providers. It is not anticipated that there will be any issues regarding the long term viability of the various haulage routes.

9.2.2 Dendrobium CHPP

ROM material from the Dendrobium mine is brought to the surface and stockpiled at Kemira Valley. From here it is reclaimed with the assistance of mobile machinery and transported by rail to the Dendrobium Coal CHPP situated at the BlueScope steel works where it is either stockpiled or fed directly into the ROM plant feed bins. There is a fixed annual haulage limit of 5.2 Mt and environmental licence requirements to limit overnight train movements, to comply with this requirement the last train for the day leaves the mine at 22:00h.

The haulage contract in place with Pacific National is considered sufficient to meet the planned production requirements over the life of mine plan. The coking coal product from the CHPP is transported by road a short distance to either PKCT or BlueScope. There is a contract in place with an external supplier for the road haulage.

As there is no facility for on-site disposal of the discard material from the DCPD it is transported to the West Cliff CHPP disposal facility. This is facilitated by the back loading of trucks delivering product coal to BlueScope from West Cliff CHPP.

As with the West Cliff Operation the Dendrobium CHPP is heavily reliant on road transportation of material with an estimated 30 Mt of product required to be delivered to PKCT and 10.2 Mt of waste transported to West Cliff CHPP over the remaining life of the operation.

9.3 Products

As discussed in **Section 9.1** Illawarra Coal produces a Bulli Coking product and energy coal as a by-product at the WCCPP whilst the DCPD produces a Wongawilli Coking product and energy coal on roughly a 60:40 ratio. The primary coking product, the Illawarra Blend, is a blend of both Bulli and Wongawilli Coking products.

All coking and energy coal products are placed on both the domestic and export markets.

The product schedule is provided in **Section 12** on Table 12-2.

9.3.1 Bulli Coking Coal

Coal from the West Cliff and Appin area of the mine are used to predominantly produce a Bulli Coking coal and a small amount of energy coal. The coking coal produced can be classed as premium low volatile hard coking coal with the following key features:

- High rank with reflectance of ~1.22%;
- Moderate ash levels;
- Low sulphur;
- moderate phosphorus, and,
- CSN of 6 rating it high quality.

Table 9-3 – Bulli Coking Coal Typical Analysis

Proximate Analysis	Units	As Received	Air Dried	Dry	Dry Ash Free
Total Moisture	%	8.0			
Moisture	%		1.0		
Ash	%	8.5	9.2	9.3	
Volatile matter	%	20.4	22.0	22.2	24.5
Total sulphur	%	0.37	0.40	0.40	0.45
Phosphorus	%	0.065	0.070	0.071	
Hardgrove grindability index			73.0		
Gross Specific Energy	kcal/kg	6,970	7,500	7,576	8,352

9.3.2 Wongawilli Coking Product

The Dendrobium CHPP processes the Wongawilli Seam to produce the Wongawilli coking coal product. The Wongawilli coking coal produced can be classed as premium low volatile hard coking coal with the following key features:

- High rank with reflectance of ~1.22%;
- Moderate ash levels;
- Low sulphur;
- Very low levels of phosphorus (0.005% ad);
- CSN of 9 rating it very high quality,
- Vitrinite levels of 85%, and
- High moisture (15.5%)

The typical analysis of the Wongawilli Coking Coal is shown in Table 9-4 below.

Table 9-4 – Wongawilli Coking Coal Typical Analysis

Proximate Analysis	Units	As Received	Air Dried	Dry	Dry Ash Free
Total Moisture	%	15.5			
As analysed moisture	%		1.0		
Ash	%	8.5	10.0	10.1	
Volatile matter	%	21.3	25.0	25.3	28.1
Total sulphur	%	0.51	0.60	0.61	0.67
Phosphorus	%	0.004	0.005	0.005	
Carbonisation Properties	%	As analysed	Ultimate Analysis		Dry ash free

9.3.3 Illawarra Blend

The Bulli and Wongawilli coking coals are blended to produce the Illawarra Blend coking coal. The typical analysis of the Illawarra Blend is provided in Table 9-5 below.

Table 9-5 – Illawarra Blend Coking Coal Typical Analysis

Proximate and other Analysis	Units	As Received	Air Dried	Dry	Dry Ash Free
Total moisture	%	10.0			
As analysed moisture	%		1.0		
Ash	%	8.6	9.5	9.5	
Volatile matter	%	21.2	23.2	23.4	25.9
Fixed carbon	%	60.3	68.3	67.0	74.1
Total sulfur	%	0.41	0.45	0.45	0.50
Phosphorus (%)	%	0.050	0.055	0.056	
Hardgrove grindability index			75		
Gross Specific Energy	kcal/kg	7,045	7,750	7,830	8,659

9.3.4 Energy Coal

Energy coal is primarily produced by the DCPD due to the inherent qualities of the Wongawilli feed coal from Dendrobium Mine. The energy coal produced by WCCPD is blended with that from the Dendrobium Processing Plant to produce the Illawarra 5600 energy product. The typical analysis of this product is provided in Table 9-6 below.

Table 9-6 – Illawarra 5600 Energy Product Typical Analysis

General Analysis	Units	As Received	Air Dried	Dry	Dry Ash Free
Total Moisture	%	6.0			
Moisture	%		1.0		
Ash	%	25.6	27.0	27.3	
Volatile Matter	%	18.0	19.0	19.2	26.4
Fixed Carbon	%	50.3	53.0	53.5	73.6
Total Sulfur	%	0.43	0.45	0.45	0.63
Gross Calorific Value	kcal/kg	5,801	6,110	6,172	8,486
	Mj/kg	24.29	25.58	25.84	35.53
	Btu/lb	10,441	10,996	11,107	15,272
Net Calorific Value	kcal/kg	5,600			
(Constant Volume)	Mj/kg	23.45			

9.4 Port Kembla Coal Terminal

The Port Kembla Coal Terminal exports around 10 to 11 million tonnes of coal and coke per annum (with capacity up to 15 million tonnes) and is privately managed by Port Kembla Coal Terminal Limited (PKCT) under lease to Port Kembla Port Corporation.

The terminal receives 60% of coal by rail and the remainder by truck. The truck receival facility includes two bins. Under-bin rotary arm plough feeders recover the coal from the bins.

Conveyor belts transport the coal from the rail and road receival bins to the stockyard.

The PKCT stockyard can accommodate up to 850 kt of coal although its optimal working capacity is around 600 kt tonnes. Three rail-mounted stackers remotely controlled from the Terminal’s Control Tower distribute the coal into stockpiles and it is stacked in individual vessel consignment lots.

The Terminal has two track-mounted operator-controlled bucket wheel reclaimers to reclaim the coal from the stockpiles for delivery via conveyor belts to the ship loader.

Berth 102 has two manually-operated ship loaders, which are rail-mounted. The average cargo size is 65 kt, although the berth has handled cargoes up to 166 kt.

Berth 101 has a mobile ship loading arrangement and is primarily used for coke and smaller coal vessels. Loading from this berth incurs a considerably higher operating cost but is an option for use by Illawarra Coal should berth 102 be unavailable or congested.

In addition Illawarra Coal has a memorandum of understanding with BSL to provide restricted access to its berths should berth 102 at PKCT not be available. This option tends to be rarely used in practice.

Port capacity is allocated on a first come first served basis and over the last few years Illawarra Coal has utilised approximately 40% of the port's annual capacity. As a result of this, there is an expectation that it will be required to contribute 40% of the cost of the upcoming \$330 million restoration and compliance project i.e. \$132 million. There are future plans for port expansion and some capital allowances have been made in the life of mine plan however these plans have not yet reached approval stage. At this point the capital allowances are estimates and no details have been provided on the increased capacity that would be achieved from these projects.

10 Environmental, Social & Facilities

The Illawarra Coal operations are closely regulated and subject to comprehensive review and assessment during the multiple levels of land use and operational approvals process, as described in **Section 3**. The operations are at a mature stage where systems and procedures, including for environmental and community management and regulatory compliance, are well established. Illawarra Coal implements an AS/NZ ISO 14001:2004 certified environmental management system over its sites and operations which involves plans, procedures, inspections and internal/external audits. The operations maintain a high level focus on continuing their social (as well as their regulatory) licence to operate by continuing liaison with its stakeholders and regulators as well as the government.

A high degree of scrutiny of the Illawarra Coal operations occurs by individuals and groups (both non-government organisations and government regulators). The stringent regulatory context and Illawarra Coal's corporate sustainability and disclosure policies ensure that the operations maintain the necessary transparency to stakeholders in terms of environmental and social performance. This includes extensive public reporting of assessment and compliance performance information on its website and ongoing stakeholder engagement via formal consultative committee meetings and liaison with technical and non-technical reference groups, supported by technical documentation and newsletters. In the case of BSO, it includes a soon to be closed community information "shop front" centre in Appin that is manned part-time and is used for stakeholder meetings.

Illawarra Coal's Community Partnerships Program has operated since 2004 to support community projects and initiatives in the region. Funding of the program is contributed by a levy of 3 cents per tonne of saleable coal from Appin and West Cliff.

Both BSO and Dendrobium mines maintain a community complaints register and incident reporting regime, the results of which are publicly reported.

The various components of the BSO and Dendrobium mines have been assessed for mine closure rehabilitation. Based on the relevant BHP Billiton guideline's conservative approach to such costing which includes at least a 35% contingency, the following mine closure costing estimates have been developed (refer Table 10-1)

Table 10-1 - Estimated Mine Closure Costs (AUD M)

Site	Closure Cost Estimate AUD M
Cordeaux Mine	14.8
Dendrobium Mine	26.2
West Cliff Colliery	58.7
Appin Mine	45.2
Borehole Rehabilitation	3.9
Logistics Facilities	28.6
Total including Contingency	177.6

10.1 Bulli Seam Operation

The regional environment of the BSO extends from Menangle in the north and Wedderburn in the north-east to near Picton and Maldon in the west and south-west and to the Sydney Catchment Authority area of Lake Cataract in the south-east and the redundant North Cliff No.3 and 4 Shafts within the Dharawal National Park in the east.

The BSO is located within existing tenements, principally Consolidated Coal Lease (CCL) 724, CCL 767, CCL 381 and Coal Lease (CL) 388, held by Illawarra Coal Holdings Pty Ltd or its subsidiary Endeavour Coal Pty Ltd. A number of exploration licences (including authorisations) are also held throughout the BSO area, as shown in **Annexure C**.

Annexure C also lists the key mining tenements, development consents and other permits associated with the Bulli Seam Operation. Figure 10-1 illustrates the areas covered by mining tenements for the BSO.

A range of infrastructure, improvements and private landholdings are located within the extent of the longwall mining area and surrounds, including houses and associated residential structures, railway infrastructure (Main Southern Railway), public roads and associated bridges (including Hume Highway), water supply infrastructure, gas infrastructure, telecommunications infrastructure, air strips, survey control marks, places of worship, public amenities, agriculture related facilities, rural building structures and farm facilities, industrial, commercial and business establishments, fire trails and other minor tracks. These provide a variety of environmental, engineering and social constraints that are addressed by a series of management plans.

The built environment comprising residences, buildings and various infrastructure are subject to specific management plans such as Property Subsidence Management Plans for each landholding, and involve any necessary repair work from mining subsidence being undertaken by the established process managed by the Mine Subsidence Board (MSB). Although a majority of the houses in the BSO area are within declared Mine Subsidence Districts, all houses and related built features are covered for repair costs by the MSB for physical damage caused by mining related subsidence. Major infrastructure is managed by way of detailed management plans developed in consultation with the infrastructure owner, relevant regulatory departments and the MSB. Again, Illawarra Coal has been involved in state-of-the-art subsidence monitoring, management and (if required) remediation of key infrastructure such as freeways and bridges, railway tracks and embankments, transmission lines and underground pipelines and cables.

The key watercourses in the BSO area are the Nepean River, Cataract River and Georges River and these have been a focus for environmental management in order to minimise impacts.

The main effects of the longwall mining process are conventional subsidence (especially tilts and strains) and unconventional subsidence (valley closure and upsidence). Where such effects may result in potential impacts to streams, swamps, cliff lines and ecological communities, then monitoring and actions in accordance with environmental management plans are rigorously applied. Illawarra Coal has developed industry-leading practices in relation to monitoring and remediation of a range of subsidence-related impacts on natural features. Recent monitoring has indicated that the impacts of the BSO are compliant with consent conditions and recent performance has been within the general expectations of the environmental assessments and approved management plans. Impacts from previous longwall operations continue to be monitored.

A Trigger-Action-Response-Plan (TARP) developed in consultation with relevant stakeholders is a typical process adopted in management plans by Illawarra Coal to appropriately and effectively manage the environmental impacts of its operations.

Management plans are in place for management and protection priorities for Aboriginal heritage features and items of European heritage.

In recent years, BSO monitoring data showed fluctuating levels of community complaints which have typically been dominated by noise complaints associated with mine safety gas drilling work and mobile plant undertaking earthworks. However, in the most recent annual reporting period to June 2014, the number of complaints has particularly risen in relation to alleged vehicle damage caused by stones flicked up by BSO's haul trucks and striking private vehicles. Procedures to review this issue and make necessary engineering and behavioural modifications are underway. The complaints management system is a means to constructively engage with the community and to work to rectify any problems.

The existing project approvals for BSO comprise longwall extraction in the domains of Appin Area 3 Extended, Appin Area 7, Appin Area 8, Appin West (Area 9) and West Cliff Area 5. While other mining domains were originally sought under the BSO project application (North Cliff, Appin Area 2, a larger proportion of Appin Area 3 and two panels in West Cliff Area 5), these were not considered feasible given the significant environmental constraints to the longwall mining plan and were eventually dropped from the application area.

The Stage 4 of the coal processing emplacement is also approved, albeit reduced in overall waste storage tonnage and height, as noted in the BSO project approval by the PAC dated 22 December 2011.

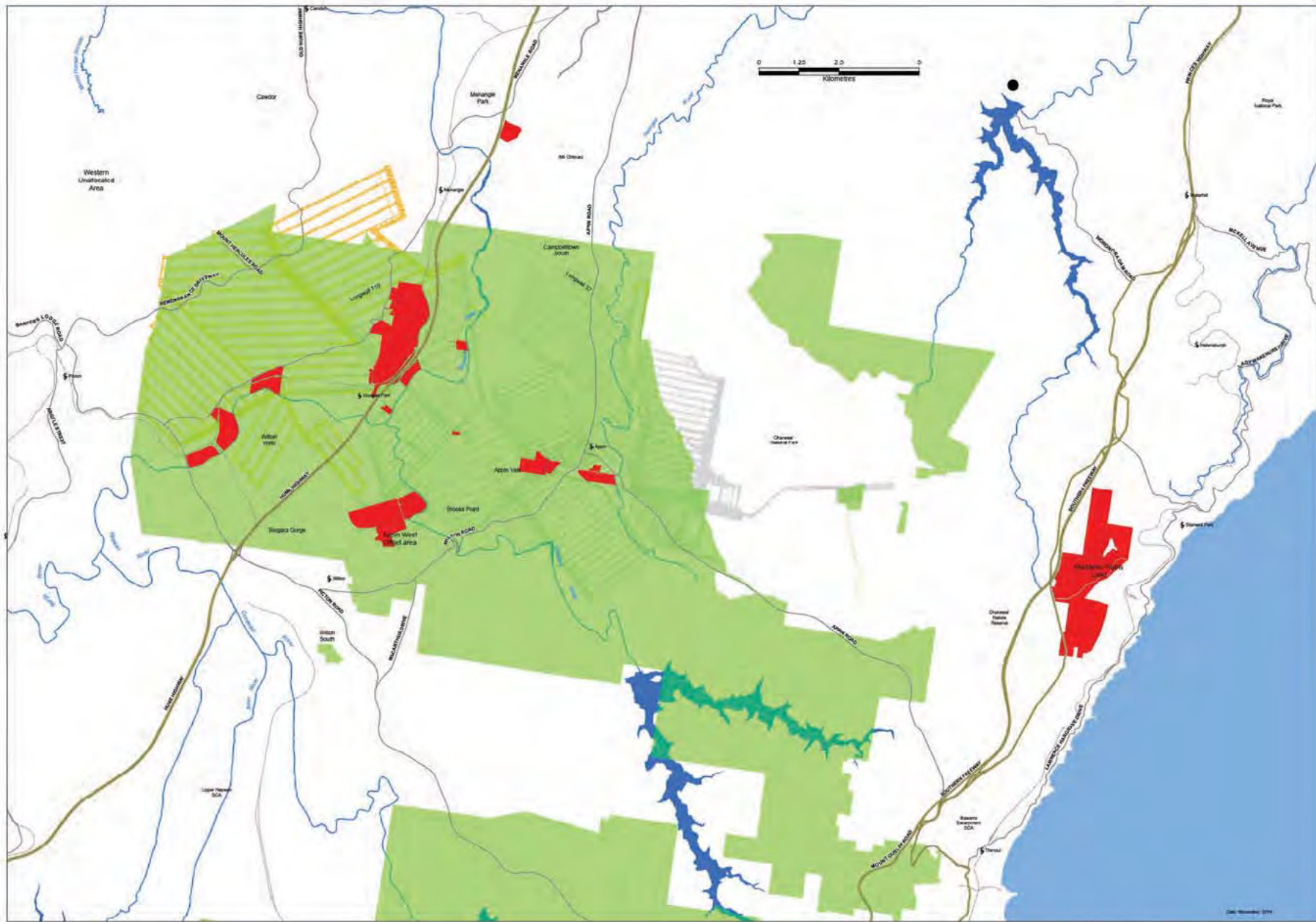

LEGEND	
■ Surface Freehold	Existing Mine Workings
■ Mining Leases	Proposed Mining

DO NOT SCALE THIS DRAWING - USE DIMENSIONS ONLY. VERIFY ALL DIMENSIONS ON SITE.

CLIENT

resourcing the future

Illawarra Coal

PROJECT

NAME: **ILLAWARRA COAL - COMPETENT PERSONS REPORT**

DRAWING: **BULLI ATLAS FREEHOLD LAND LEASES**

FIGURE No: 10.1	PROJECT No: ADV-SY-04120	Date: March 2015
--------------------	-----------------------------	---------------------

The other key elements of the approved BSO activities include:

- Upgrades of existing surface facilities and supporting infrastructure;
- Continued and expanded placement of coal processing at the four stage West Cliff Coal Preparation Plant Emplacement;
- Continued road transport of ROM coal from the Appin East pit top to the West Cliff Coal Preparation Plant;
- Continued road transport of ROM coal from the Appin East pit top and West Cliff pit top via the public road network to the Dendrobium Coal Preparation Plant at Port Kembla;
- Continued road transport of product coal from the West Cliff Coal Preparation Plant via the public road network to Blue Scope Steelworks, PKCT and local coke works;
- Ongoing surface monitoring and rehabilitation and remediation of subsidence impacts, and
- Associated minor infrastructure, plant, equipment and activities.

A range of management plans are in place to address specific areas of the BSO activities and impacts, a sample of which includes the following:

- Appin Area 7 Dyke Backfill Project - Service Boreholes Management Plan;
- Appin East to West Cliff Services Connection Management Plan;
- Air Quality and Greenhouse Gas Management Plan;
- Environmental Management Strategy;
- Heritage Management Plan;
- Gas Drainage Management Plan;
- Gas Drainage Management Plan - Appin Longwalls 706 – 708;
- Mining Operations Plan (October 2012 - September 2019);
- Noise Management Plan;
- Persoonia Hirsuta Offset Management Plan;
- Service Boreholes Management Plan;
- Surface Water Management Plan;
- Waste Management Plan;
- Shale Sandstone Transition Forest Offset Management Plan;
- Pollution Incident Response Management Plan - EPL2504;
- Broad-headed Snake Management Plan;
- Southern Brown Bandicoot Management Plan;
- Management Plan for Water Sensitive EPBC Species, and,
- West Cliff Coal Wash Emplacement Area Management Plan.

Selected areas of the future longwall domains in the BSO are subject to change in land use in response to urban development pressure. An area of rural land has been rezoned and a large multi-stage subdivision of large residences constructed around a golf course near Wilton in Appin Area 8 near the Hume Highway – Picton Rd intersection. Rezoning pressures are likely to continue in the future and this accompanies a shift in landholder demographics.

This trend could add to the existing challenges for securing land access such as for drilling surface to seam gas drainage holes. It also reinforces the importance of Illawarra Coal's recognition for the need for ongoing stakeholder engagement and maintaining a social licence to operate.

10.2 Dendrobium

The Dendrobium mine pit top is located at Mt Kembla approximately 8 km west of Wollongong on the NSW Illawarra Escarpment. It comprises administration, workshop, and people & materials access via the Dendrobium tunnel to the underground workings. The wider Dendrobium operation consists of a number of sites in addition to the mine pit top site:

- Kemira Valley coal loading facility – coal clearance via the Kemira Valley tunnel, stockpile and train loading facility and coal sizer;
- No. 1 Ventilation Shaft – originally operated as an upcast shaft but since decommissioned;
- No. 2 and 3 Ventilation Shaft – upcast ventilation shaft and fan providing fresh air to the mine for Area 3;
- Kemira Valley rail line – transport route from stockpile facilities to the Port Kembla steel works;
- Dendrobium CHPP – located within Bluescope Steelworks providing coal processing facilities for the Dendrobium coal product;
- The West Cliff coal emplacement area, and
- Mining Areas 1, 2 and 3 which are positioned between Lake Cordeaux in the north-east and Lake Avon in the south-west.

The main mining lease covering the Dendrobium operation is CCL 768. Development consent is in place for the mining domain in Area 3 (comprising the domains known as Areas 3A, 3B and 3C). Detailed longwall mining approval by way of approved SMPs in Area 3 to date extends up to and including LW 13 in Area 3B and also LW 19 in Area 3A. Detailed approval to allow mining of further longwall panels LW 14 to 19 will require an additional application by SMP and/or Extraction Plan.

The key mining tenements, development consents and other permits associated with the Dendrobium Mine are shown in **Annexure C**. Figure 10-2 illustrates the areas covered by mining tenements relevant to the Dendrobium operation.

A range of environmental management plans are in place to address issues associated with Dendrobium surface facilities and longwall mining activity:

- Air Quality Management Plan;
- Bushfire Management Plan;
- Greenhouse Gas and Energy Efficiency Plan;
- ICH Greenhouse Gas and Energy Efficiency Management Plan;
- Landscape Management Plan;
- Lightning Management Plan;

- Noise Management Plan;
- Traffic Management Plan;
- Waste Management Plan;
- Water Management Plan;
- Subsidence Management Plan;
- Asset Protection Plan;
- Groundwater Management Plan;
- Swamp Impact, Monitoring, Management and Contingency Plan;
- Watercourse Impact, Monitoring, Management and Contingency Plan; and
- Pollution Incident Response Management Plan - EPL3241.

The natural physical and ecological environmental features provide the key constraints and management challenges for the Dendrobium operation. As is the case for BSO, these management plans form the basis of a systematic approach to environmental and social management across the operation. Illawarra Coal has demonstrated significant experience in managing environmental issues associated with mining beneath water supply catchments and various types of surface landscapes.

Waterbodies, watercourses and catchments above the Dendrobium longwall area include Lake Cordeaux, Cordeaux River, Wongawilli Creek, Lake Avon, Donalds Castle Creek and Sandy Creek which are within the Sydney Water Catchment Special Areas and part of which is in the Dam Safety Committee Notification Area for Lakes Cordeaux and Avon.

The pit top area at Mt Kembla is within the catchment of American Creek and Water and Brandy Creek which flow to Allans Creek and then the Inner Harbour of Port Kembla. The pit top is located within 500 m of the Mt Kembla village.

The Kemira Valley rail line is a private facility which passes close to residential areas and its operations are subject to stringent noise restrictions, with rail movements not allowed between 11 pm and 6 am.

Apart from a few linear disturbances for infrastructure (tracks, power lines, rail easement, etc.), the surface lands above the Dendrobium planned extraction areas consist largely of undisturbed native vegetation. Areas of steep slopes, cliff lines, Aboriginal heritage sites, key watercourses, swamps and waterfalls have been delineated and mining has been planned and approved on the basis of thorough risk-based environmental assessment.

The successful protection of Sandy Creek waterfall from any adverse subsidence impacts demonstrated leading industry practice in this field of monitoring, modelling and safeguarding of the effects of subsidence on significant geomorphic features while enabling reasonable coal extraction opportunity. This recent experience builds on years of trials of innovative preventative and remedial actions for management of environmental impacts and consequences of mining subsidence. This well regarded experience in safeguarding natural features is matched by excellent subsidence management history with pipelines, freeways, bridges and transmission lines.

Further, Wongawilli Creek is afforded an appropriate degree of protection in the mine plan by the positioning of the underground main headings that separate Areas 3A and 3B to align beneath the north-south watercourse. Recent and current mining areas feature swamps and steep areas, studies to date indicate that although steep areas are reasonably common in current and future mining areas, swamps are not a major feature.

A Biodiversity Offset Strategy is in place to offset any potential ecosystem and related hydrological impacts in LW 9-13. Illawarra Coal owns appropriate lands for offsetting purposes.

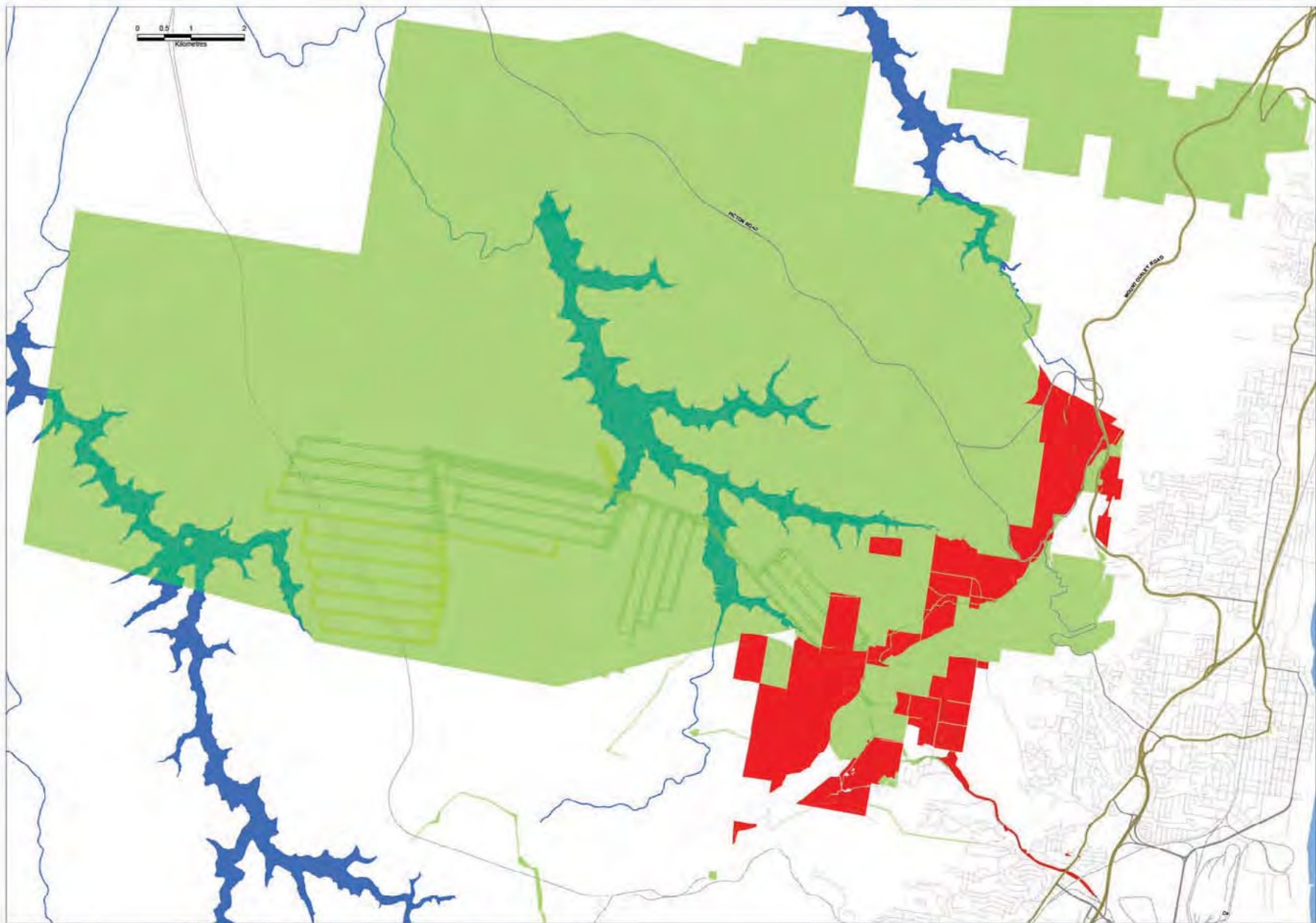

LEGEND	
■ Surface Freehold	Existing Mine Workings
■ Mining Leases	Proposed Mining

N
↑

DO NOT SCALE THIS DRAWING - USE FIGURED DIMENSIONS ONLY VERIFY ALL DIMENSIONS ON SITE

CLIENT



resourcing the future
Illawarra Coal

PROJECT

NAME
ILLAWARRA COAL - COMPETENT PERSONS REPORT

DRAWING
WONGA ATLAS FREEHOLD LAND LEASES

FIGURE No. 10.2	PROJECT No. ADV-SY-04120	Date March 2015
--------------------	-----------------------------	--------------------

11 Operating & Capital Costs

11.1 Operating Costs

The operating costs for Illawarra Coal have been developed for the main cost centres associated with the following:

- Mine Costs (underground activity to the pit head);
- Raw coal logistics (the movement of raw coal through and around surface facilities);
- Processing (the processing of Run of Mine coal to saleable product);
- Refuse emplacement (the cost of the management of waste from processing activity);
- Clean coal logistics (the management and transportation of coal product from processing plants to the port);
- Port (the tariffs and levies paid for using port facilities);
- Closure (any costs associated with the closure and rehabilitation of operations);
- Marketing; and
- G&A (General and Administration – head office and other centralised costs).

11.1.1 Mining Costs

Mining costs comprise the following components:

- Development (the cost mining main headings and gateroads to service the longwall);
- Longwall;
- Gas drainage;
- Mine services (the cost of installation and maintenance of services such as water supply, power supply, communications, underground roads, dewatering);
- Coal clearance (the installation and maintenance of all belt conveyors underground);
- Surface Services (the manning and maintenance of workshops, storage areas and other activities on the surface); and,
- Other (Overhead costs including management, technical and office staff, in some cases recharges and levies).

Table 11-1 illustrates the average life of mine unit cost rates estimates for each of the longwall mines. West Cliff and Appin Areas 7, 8 and 9 all operate in the Bulli Seam within the same mining complex and experience similar mining conditions. The Appin Areas exhibit relatively similar cost profiles, with the averages ranging between AUD 53.10/t ROM and AUD 59.60/t ROM.

The West Cliff costs are marginally lower than the other Appin Areas but this is a result of the mine reaching the end of its life. As at the 1st January 2015, a small amount of development is required at West Cliff, but for the majority its remaining mine life, there will be no further development. Gas drainage has also largely been completed and will attract minimal additional cost.

As West Cliff will be replaced by Appin Area 9 and the West Cliff surface infrastructure will continue to be used, there are no redundancy or closure costs built into the valuation model.

The Dendrobium Mine has a much lower cost profile than the BSO as a result of significantly less development requirement, no gas drainage or gas constraints on mining and a less-complex mine access and coal clearance system.

Table 11-1 –Life of Mine Mining Cost Breakdown (AUD/t ROM)

Activity	WC	Area 7	Area 8	Area 9	Dend	Weighted Average
Development	0.00	11.70	16.60	16.20	4.60	11.50
Longwall	9.50	11.90	10.60	12.50	7.50	10.70
Gas Drainage	2.20	4.70	4.00	3.80	0.30	3.60
Mine services	9.70	10.50	8.70	8.20	7.40	9.10
Coal clearance	4.10	6.00	3.60	3.40	2.00	4.10
Surface services	3.70	4.30	6.60	6.20	0.70	4.70
Other	5.90	10.50	5.80	3.40	4.80	8.40
Total	53.10	59.60	55.80	53.80	27.20	52.10

Source: RPM estimate based on information supplied by Illawarra Coal.

Figure 11-1 shows the average cost profile for the mining operations over the life of the Project. The first five forecast years are provided annually and grouped into five-years thereafter. Actual unit costs for FY2012 to FY2014 have been provided for comparison. Milestone dates where mining ceases in a particular area have been highlighted.

The elevated unit cost in FY2014 is due to:

- Lower output for the year as a result of the geotechnical incidents that occurred at the Dendrobium Mine; and,
- The increased costs associated with the development of Area 9.

There is a step improvement in cost from the first year of the forecast which is largely attributable to the cost saving initiatives implemented at the start of FY2015.

A general trend of increasing cost is observed over the life of the Project. Points of note regarding the trend are as follows:

- The closure of Dendrobium in FY2023 removes low-cost coal from the profile and results in a subsequent step increase in unit cost; and,
- Cost increases have been allowed in the model to allow for more aggressive geotechnical conditions as the Appin mines get deeper and additional costs associated with increasing travel distance for personnel and coal clearance.

Figure 11-1 – Mining Cost Profile

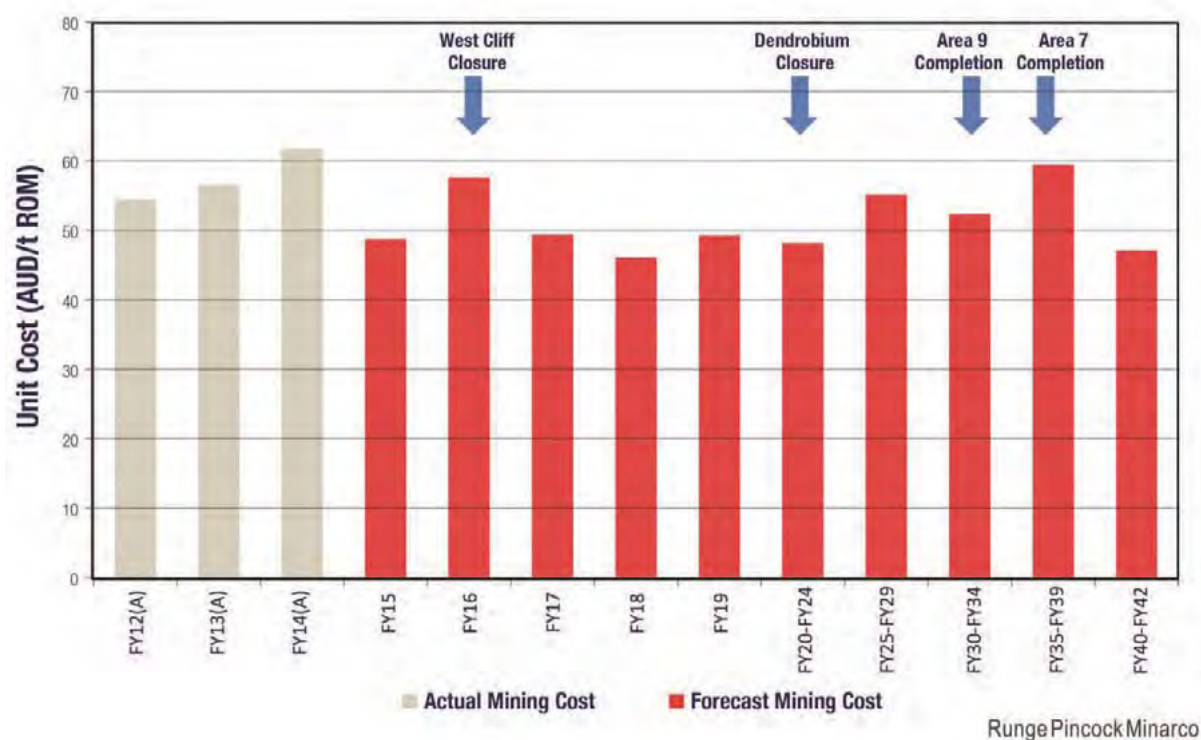

Source: RPM estimate based on information supplied by Illawarra Coal.

11.1.2 Raw Coal Logistics Costs

Raw coal logistics costs are associated with the transportation and management of ROM coal from their delivery point at the surface to the relevant processing plant. This includes stockpiling cost, trucking and rail. While three longwalls are operating the cost of raw coal logistics averages at AUD 2.25/t ROM.

Dendrobium coal incurs the highest raw coal logistics cost with stockpiling and rail cost to the Dendrobium Processing Plant at Port Kembla averaging AUD 3.75/t ROM.

The coal reporting to Appin East is the highest cost at BSO with trucking to the West Cliff Processing Plant and subsequent stockpiling averaging AUD 3.60/t ROM. In contrast the underground feed delivered through the West Cliff shaft has no trucking cost and has AUD 1.25/t ROM for stockpiling.

11.1.3 Coal Processing Costs

Coal from the BSO is processed at the West Cliff Coal Preparation Plant. The costs attributed to West Cliff Preparation Plant have been divided into processing cost and on-site logistics cost. A processing cost of AUD 3.90/t feed, has been applied with the addition of AUD 1.60/t feed, for on-site logistics, resulting in an average cost of AUD 5.50/t feed.

The Dendrobium ROM coal is processed through the Dendrobium Processing Plant for which processing costs have been estimated but due to the arrangement of the plant itself there are no on-site logistics costs. The processing costs at Dendrobium average AUD 5.30/t feed, over the life of the operation.

11.1.4 Refuse Emplacement Costs

Refuse or reject from the coal processing plants is deposited in the West Cliff emplacement area. Whilst the refuse from the West Cliff Preparation Plant can be directly disposed on the site's emplacement area, this is not possible for the Dendrobium Processing Plant which is embedded

within the steelworks site at Port Kembla. The Dendrobium Processing Plant refuse is transported by truck to the West Cliff refuse emplacement area.

The refuse emplacement cost comprises transportation from Dendrobium Processing Plant to West Cliff as well as a levy charged for waste disposal remote of the production site.

The costs incurred in the refuse emplacement average AUD 6.7 M per year or approximately AUD 3/t refuse from Dendrobium placed in the West Cliff emplacement area.

11.1.5 Clean Coal Logistics Costs

Clean or product coal logistics costs include product coal stockpile handling costs and product coal transport costs from West Cliff Processing Plant and Dendrobium Processing Plant to the customer or port facility.

The majority of the West Cliff product is transported to the Port Kembla area at a cost of around AUD 7.50/t sales. In addition a cost of AUD 0.80/t sales is incurred for stockpiling at West Cliff.

A cost of AUD 2.90/t sales is incurred on the Dendrobium product that is transported to the PKCT.

11.1.6 Port Costs

As outlined in **Section 9**, PKCT has in recent history had difficulty coping with the throughput requested of its users. To overcome this bottleneck, the owners and users have an upgrade plan to overcome this issue.

The other PKCT operating costs comprise of:

- The costs associated with ship loading through the main berth 102 at PKCT. The PKCT unit cost for this activity is expected to decrease by around 20% in the medium term, once PKCT has been reconfigured and upgraded with higher throughput capacity.
- It is also planned to make provision to load the coal destined for a domestic customer through berth 101 in 2015. There is no ongoing provision to load this annual contract tonnage to this domestic customer through berth 102 as it is felt the annual tonnage of export sales and domestic sales to this customer, along with other port users sales can be accommodated through berth 102. RPM agrees with this view.
- While loading through berth 102, before the medium term port capacity upgrade is complete, BHP Billiton has made a provision for demurrage associated with the tonnage loaded through the berth. The provision totals AUD 27.7M through to 2019. RPM agrees with this provision.
- There is also a small provision to load about 0.1 Mtpa for 8 years (2015 to 2022) through an alternate berth at PKCT at a higher rate than berth 102.

RPM considers that the PKCT costs are a fair and reasonable estimate for this activity.

11.1.7 Closure and Rehabilitation Costs

The closure and rehabilitation costs have been discussed in **Section 10** of this report. The Wongawilli mine sites of Cordeaux, Dendrobium and Dendrobium Processing Plant will require an estimated outlay of AUD 72.3 M for closure and this has been scheduled to be spent after the completion of Dendrobium mining in 2023.

The closure and rehabilitation costs associated with the Bulli Seam mining operations at Appin East and West, West Cliff and the Appin Area 9 Project surface infrastructure are estimated to cost AUD 106.9 M which is forecast to be incurred at the completion of Appin East and West mining in 2042.

In total AUD 179.2 M has been provided for mine closure and rehabilitation. RPM considers this is a fair and reasonable estimation for such costs.

11.1.8 Marketing costs

Marketing costs include a marketing commission and a marketing fee paid to a related party that market the export coking coal and export thermal coal on behalf of Illawarra Coal.

An average total marketing cost of approximately AUD 1.90/t of export coking coal and export thermal coal has been applied over the life of mine. This is considered to be a reasonable marketing cost to incur for a professional marketing service being provided and the subsequent coal price being provided by the marketing agent.

11.1.9 General Administration Costs

The General Administration (G&A) costs are associated with the cost of providing centralised management and services across the entire operation. The majority of these services are provided from the Illawarra Coal head office located in Wollongong. This services provided include corporate management, processing and logistics management, human resources, financial services, engineering services and underground technical support and long-term mine planning.

The cost of providing these services averages AUD 9/t sales while three longwalls are in operation and increases to an average exceeding AUD 20/t sales towards the end of the asset life as the number of longwalls reduces and economies of scale are lost.

11.1.10 Total Operating Costs

Table 11-2 shows the average cost breakdown for Illawarra Coal over the life of the Project. Mining is responsible for over half of the cost followed by General and Administration costs accounting for 12% of the total. Processing and clean coal logistics are the next highest contributors at just over 7% each.

As illustrated in Figure 11-2 mine costs are highly dependent upon the mines in operation and their specific activity during any period. G&A costs are largely fixed although these are reduced as the total activity and output of the business decreases over time. Closure costs impact the unit cost in the year of the Dendrobium closure and more significantly at the completion of the BSO. The remainder of the costs are largely variable relative to coal throughput.

Table 11-2 – Total Operating Costs (AUD/t sales)

Operating Unit Costs	
Mine Costs	66.80
Raw Coal Logistics	2.00
Processing	7.30
Refuse emplacement	0.40
Clean coal logistics	7.20
Port	3.60
Closure	1.10
Marketing	1.90
G&A	11.80
Total	102.10

Source: *RPM estimate based on information supplied by Illawarra Coal.*

Figure 11-2 shows the total unit cost profile over the life of the asset. Total costs typically range between AUD 90/t sales and AUD 100/t sales of the remaining life of the asset. Costs increase during FY2025 to FY2035 due to the loss of the low cost Dendrobium contribution to the blend and deeper more challenging conditions at the BSO. From FY2035 costs significantly increase as Area 7 ceases operation and economies of scale are reduced.

Figure 11-2 – Total Cost (AUD/t produced)

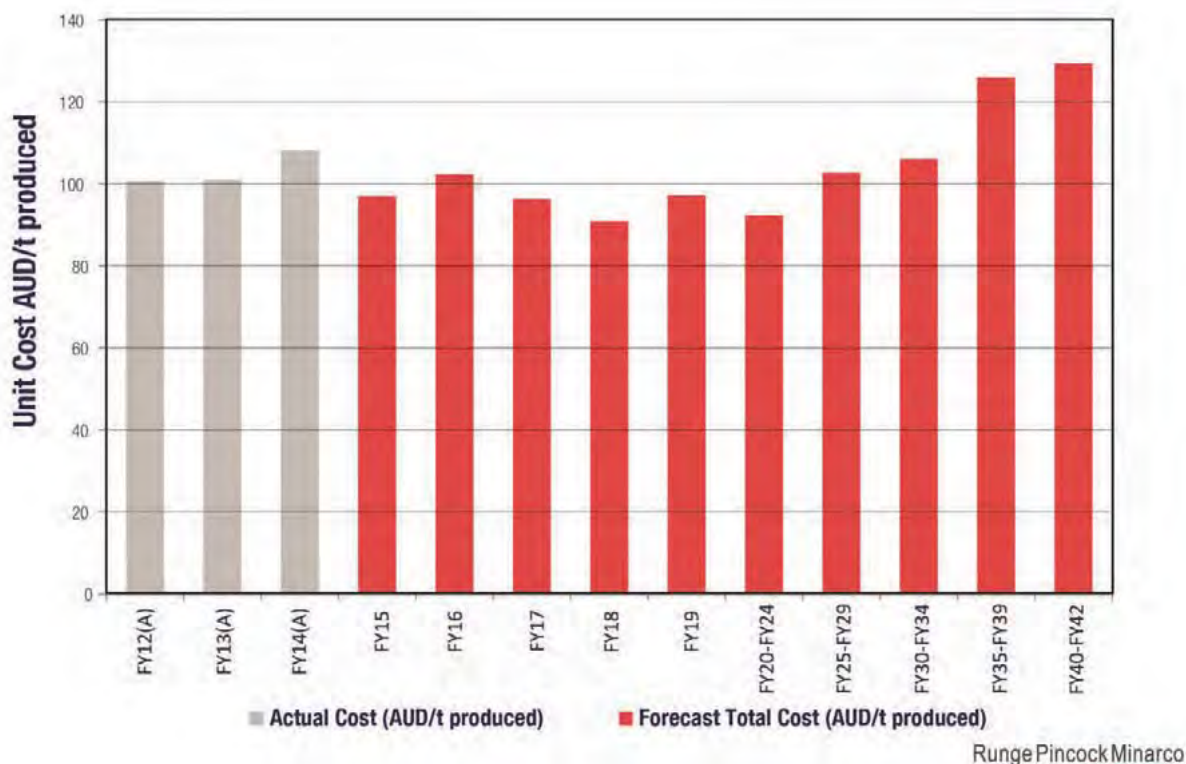

11.2 Capital Expenditure

Total capital expenditure across the life of the asset is forecast at AUD 2,997 M consisting of AUD 2,368 M in sustaining capital, AUD 407 M for major projects, and AUD 222 M in growth capital. Figure 11-3 illustrates the average annual capital spend over the life of the asset with a cumulative line inserted to plot the progression of total spend over this period.

Figure 11-3 - Illawarra Coal Capital Expenditure Plan

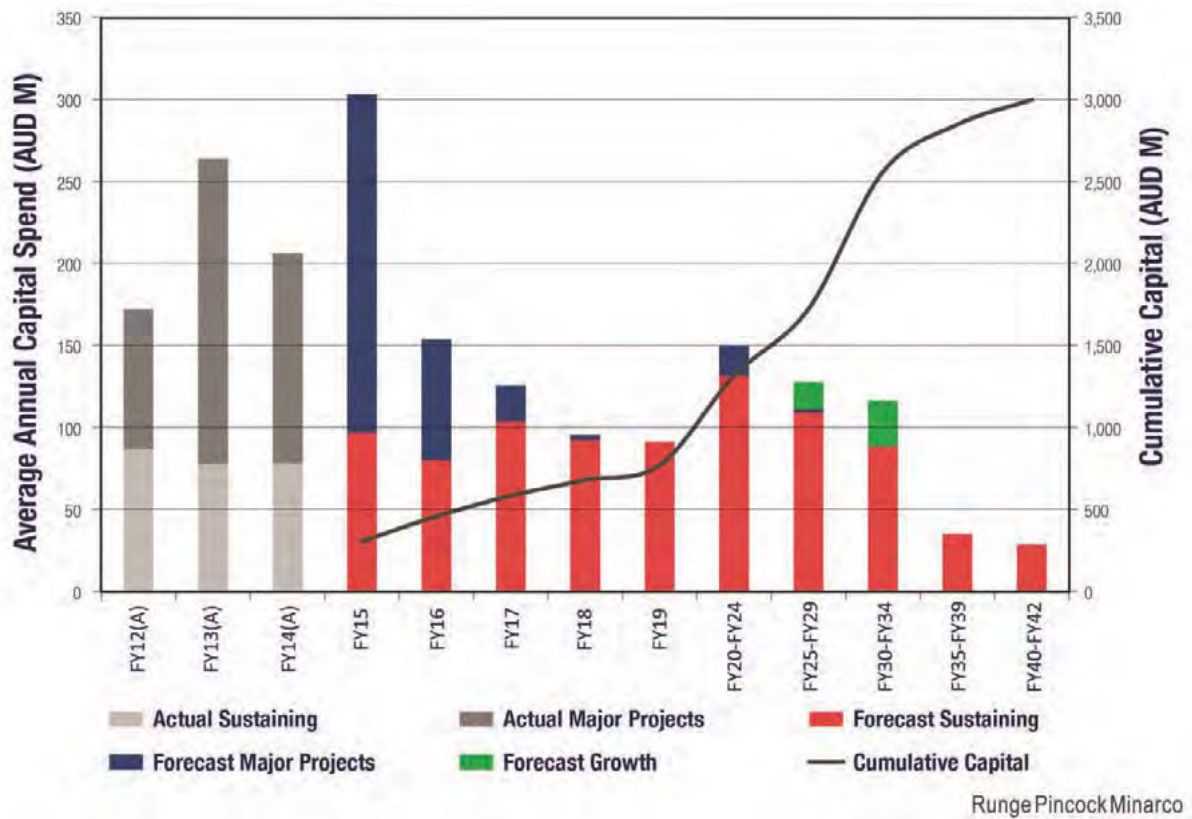

11.2.1 Major Projects

Illawarra Coal is undergoing a period of significant operational change which is reflected in an increase in capital spend on major project. The major projects identified within the valuation are listed on Table 11-3 below.

Table 11-3 – Five-Year Plan for Major Capital Projects

Project	Total Project value (AUD M)	FY2015 (AUD M)	FY2016 (AUD M)	FY2017 (AUD M)	FY2018 (AUD M)	FY2019 (AUD M)
Appin Area 9	115	85	27	3		
Additional Longwall Supports	94	94				
Mount Batten Gas Plant	36	8	26	2		

Source: Information supplied by Illawarra Coal.

- The Appin Area 9 project encompasses the remaining items necessary for the set-up of mining in this area. This includes completion of the ventilation shaft, ongoing mains development and the establishment of the first two longwall panels.
- The remaining AUD 94 M associated with the Additional Longwall Supports Project is for the overhaul of the old Dendrobium longwall powered roof supports and relocation to BSO.
- The ongoing expansion of longwall operations at Appin necessitates an associated expansion of the gas drainage infrastructure. This expansion is important from a capacity perspective as well as providing infrastructure in the locations required by mining activity. The Mount Batten Gas Plant has been identified as an important part of the system expansion and appropriate capital funds have been allocated to this project.

- As a shareholder in Port Kembla Coal Terminal Ltd, Illawarra Coal is required to fund its share of the planned restoration and compliance. The PKCT operation is required to meet all current legislative requirements and the equipment is to be restored to its original functionality. In addition, there are future plans for the potential expansion of PKCT's capacity. The expansion project is still in definition phase, however based upon Illawarra Coal's historical port usage, AUD 132 M has been included in the valuation model, over the first five years of the plan, to cover the anticipated proportion of the overall cost.

The Appin Coal Clearance Project (ACCP) has not been included in the five-year major capital projects list as further engineering work is required before the project can be authorised. The ACCP offers an opportunity to improve productivity, over and above that used in the valuation, by debottlenecking outbye coal clearance at the BSO. The Appin Drift is currently the system constraint and by regulating coal flow through the drift, and rationalising the split of coal between the Appin Drift and the West Cliff winder, the system capacity can be improved. Illawarra Coal estimate that productivity improvements between 7% and 10% can be achieved in Appin Areas 7, 8 and 9. Should the project proceed it is estimated to cost AUD120 M over 4 years, with productivity improvements anticipated from FY2019. RPM have not modelled the NPV impact of the implementation of this project.

11.2.2 Sustaining Capital

Within the valuation model an estimation of sustaining capital expenditure has been made through modelling major equipment replacements based on their expected life and an estimate of the ongoing capital needs to replace and upgrade equipment across the operation.

The mine budgeting process has identified AUD 463 M of sustaining capital requirements within the five year plan. For capital planning purposes outside of the detailed five year planning horizon, allowances have been made based on historical data for sustaining capital. The breakdown of these is listed in Table 11-4 below.

Table 11-4 – Sustaining Capital Allowances FY2020 – FY2042

Project	Total Capital Budgeting Allowance (AUD M)	Annual Capital Budget Allowance from FY20
Major Plant Refurbishment	160	AUD 53.4 M on each occurrence
General Mining	834	AUD 5.25 per ROM tonne
Conveyors	106	AUD 4.6 M per year
WCCPP	109	AUD 4.7 M per year
DCPP	24	AUD 4.7 M per year
Regional Office	121	AUD 5.25 M per year
Stage 4 Emplacement	21	Once off project
Total	1,375	

Source: Information supplied by Illawarra Coal.

As each financial year progressively enters the five year planning horizon, the general allowances will be replaced with more accurate estimates based on a specific list of projects required to sustain the operation.

Major upgrades to the WCCPP have been scheduled in FY2024, FY2029 and FY2034 at a value of AUD 53.4 M each.

The Stage 4 Emplacement project relates to the construction of a new emplacement area at West Cliff. A single capital allowance of AUD 21.2 M has been set aside for this work in F20Y31.

Ventilation Shaft Construction

As the mine expands, the ventilation load will increase necessitating the construction of additional ventilation shafts. Based on the costs associated with the construction of the Appin Area 9 ventilation shaft, each shaft is estimated to cost AUD 85.4 M. Current planning has the next shaft constructed in FY 2020 /21 and a second in FY2028.

Continuous Miner Replacements

The ongoing replacement of the operations' continuous miners is an integral part of the management of the lifecycle of these machines. The life of each machine has been estimated at 10 years with a current replacement value of AUD 6.2 M. Based on the expected development schedule of the operations and the age of the existing machines, this will result in three machines being purchased in FY2020 and four in FY2027.

Longwall Equipment Replacement

The longwall mining system is made up of a number of sub sets of equipment that are overhauled and replaced on a group basis. The major component of the longwall, the powered roof supports, are estimated to have a life of 10 years. Replacement value of a set of powered roof supports is currently estimated to be AUD106 M. Based on the current production schedule and the age of the existing equipment, three sets of new supports will be required over the life of the operation. All of these will be commissioned in the BSO and have been scheduled for FY2021, FY2029 and FY2031.

11.2.3 Growth Capital

Over and above the capital required to meet the planned mine production, it has been recognised that early expenditure will be required for the eventual move into Appin Area 8. As a result a total of AUD 222 M has been included in the plan from FY2027 to FY2032 for this project.

12 Valuation of Reserves

RPM used a Net Present Value (NPV) approach to estimate the value of the Coal Reserves at Illawarra Coal. A deterministic approach was taken with estimations taken on the valuation inputs, based on historical performance, future planned activity and RPM’s professional view of expected outcomes. Sensitivity assessment was applied to the expected outcome in order to illustrate the robustness of the asset to change in the inputs.

The Coal Reserves have been valued based on the forecast quantities remaining at 31st December 2014.

A Net Present Value estimate for the coal reserves, as forecast as at 31st December 2014, at Illawarra Coal is USD 1,517 M applying a 10% discount rate.

Figure 12-1 provides a tornado chart illustrating the robustness of the asset to +/- 10% applied to operating expenditure, capital expenditure, foreign exchange and coal price. As annotated on the chart, in all cases a positive value is maintained in all sensitivity cases. The asset is most sensitive to coal price and operating expenditure but has limited sensitivity to capital expenditure.

Figure 12-1 – Valuation Sensitivity Assessment (USD M)

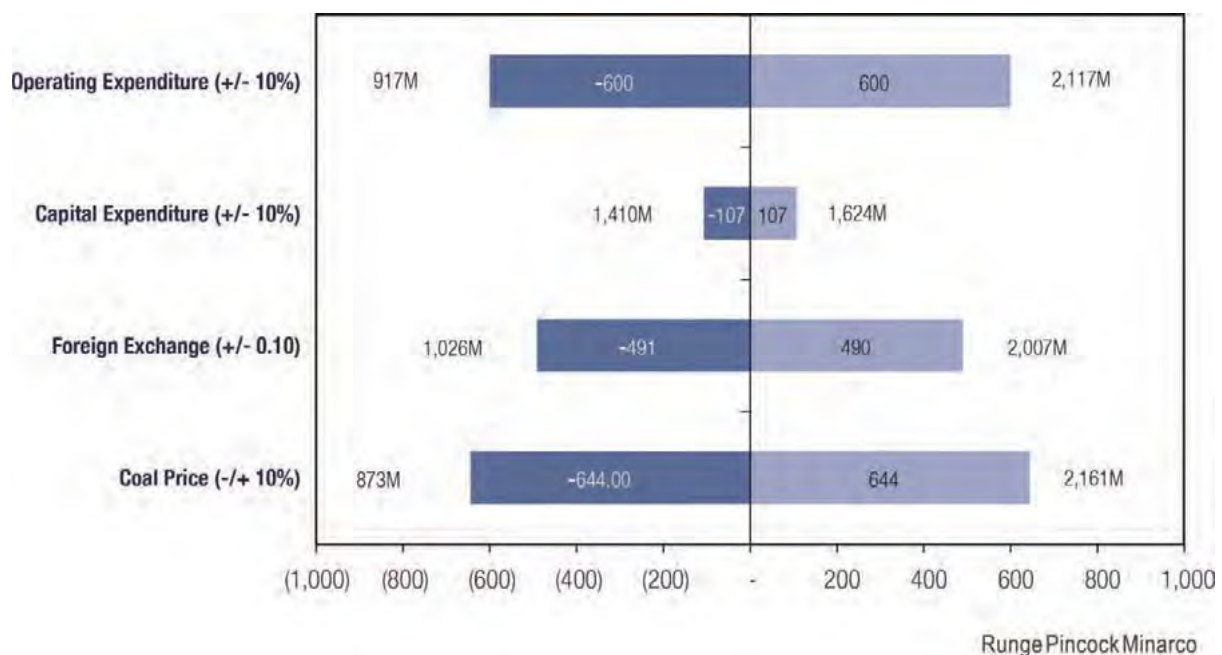

RPM completed sensitivity analysis on the current project discount rate of 10% with a sensitivity of +/- 2%. The results are as follows:

Discount Rate (%)	NPV USD M
8 %	1,748
10 %	1,517
12 %	1,330

12.1 Valuation Methodology

The valuation methodology adopted by RPM is the Net Present Value (NPV) of the discounted cash flow of the Reserves economic model. This methodology has been adopted by RPM as suitable for the mineral asset under consideration in accordance with the guidelines offered by the VALMIN Code. In selecting this methodology RPM has taken account of the following factors:

- The nature of the valuation;
- The development status of the mineral asset; and
- The extent and reliability of the available information.

RPM utilised a Project economic model developed in Microsoft Excel. The model is in real 2015 Australian dollars and is a 100% equity model.

Illawarra Coal initially developed the economic model to regularly determine and update asset value for its internal purposes. The logic within the economic model has been examined, comprehended and updated by RPM for the purposes of this valuation. RPM is satisfied that the economic model architecture is appropriate for determining asset NPV. It has been well constructed and has appropriate checking and audit mechanisms. RPM is satisfied that the mechanisms within the model are appropriate and suitable for a deterministic approach to calculating asset NPV.

As highlighted at the start of this section RPM has quantified each of the inputs, based on historical performance, future planned activity and RPM's professional view of expected outcomes. In order to conduct this quantification RPM experts relied upon documentary evidence provided by Illawarra Coal.

12.2 Valuation Modelling Parameters

12.2.1 Macro-economic parameters

The key macro-economic parameters applied in the economic model, as determined by RPM, are:

- Australian dollar inflation 2% per annum constant, from 2015 to 2042;
- US dollar inflation 2% per annum constant, from 2015 to 2042; and
- US dollar: Australian dollar foreign exchange rate (FX) is based on a consensus view (mean view) of numerous internationally recognised forecasting organisations. The 2015 FX rate is 0.87, 2016 is 0.85 and 2017 to 2042 is 0.84.

12.2.2 Production Quantities

As the Coal Reserve Valuation date is 31st December 2014, forecast production quantities are based on the Coal Reserves as at 30th June 2014 which have been depleted for coal production to 31st December 2014 and minor updates have been applied based on RPM's Coal Reserve review.

Production quantities have been imported from the XPAC production schedules. The key production quantity inputs are:

- ROM coal mined by development by mining area;
- ROM coal mined by longwall by mining area;
- ROM coal processed in the coal handling and processing plants (CHPP);
- Product coal produced from the CHPP; and
- Product available to be sold and classified as customer sales.

Table 12-1 shows the mine production figures for the last three financial years and the life of asset forecast while Table 12-2 shows the products produced over the same period.

Table 12-1 – Run of Mine Production Profile

ROM Coal Production		Actual			Forecast									
		FY12(A)	FY13(A)	FY14(A)	FY15	FY16	FY17	FY18	FY19	FY20- FY24	FY25- FY29	FY30- FY34	FY35- FY39	FY40- FY42
Total Output														
West Cliff	Mt (ROM)	2.50	2.95	2.81	2.97	3.23	0.10							
Area 7	Mt (ROM)	3.51	2.87	3.28	4.06	3.39	3.15	3.57	3.17	16.32	16.26	15.70	0.55	-
Area 8	Mt (ROM)										0.36	11.57	18.80	8.00
Area 9	Mt (ROM)	0.12	0.08	-	0.17	0.34	3.06	4.06	3.53	20.45	21.91	9.57	-	-
Dendrobium	Mt (ROM)	4.33	4.54	3.85	4.91	4.84	4.83	4.74	4.56	19.29				
Total	Mt (ROM)	10.46	10.44	9.94	12.10	11.81	11.13	12.38	11.27	56.07	38.53	36.84	19.35	8.00

Source: RPM estimate based on information supplied by Illawarra Coal.

Table 12-2 – Product Profile

Sales		Actual			Forecast									
		FY12(A)	FY13(A)	FY14(A)	FY15	FY16	FY17	FY18	FY19	FY20- FY24	FY25- FY29	FY30- FY34	FY35- FY39	FY40- FY42
Total Sales (Mt)														
Coking	Mt	6.2	7.0	5.9	7.4	7.6	7.4	8.4	7.4	39.1	29.5	26.0	14.0	6.1
Energy	Mt	1.1	1.4	1.6	1.7	1.7	1.5	1.5	1.5	6.3	0.7	0.8	0.2	0.3
Total	Mt	7.3	8.4	7.5	9.2	9.3	8.9	10.0	9.0	45.4	30.2	26.8	14.1	6.4

Source: RPM estimate based on information supplied by Illawarra Coal.

RPM notes that in the mining of the Illawarra Coal Reserves an amount of 10.9 Mt of non-reserve coal is also mined in the Appin 7, Appin 8 and Appin 9 mining area mine plans. This non-reserve is from Inferred classified Coal Resources.

For valuation purposes it is assumed that this material is waste that must be extracted as part of the mining process. Extraction costs are therefore applied but the material is removed from the process stream as soon as it reaches the surface. These resources can only be valued when their resource classification has been elevated to at least Indicated status and an assessment of modifying factors confirm their conversion to a reserve.

12.2.3 Product Coal Prices and Revenue

Product coal price forecasts for use in the economic model are derived from a consensus view (mean view) of up to 15 internationally recognised organisations that are in the business of forecasting commodity prices. The forecast coal prices were current as at October 2014.

RPM has taken the raw data published in this Consensus Forecast and manipulated it into a format suitable for input into the economic model. The two key product coal price forecasts determined are:

- The Australian Coking Coal Forecast in USD/t; and
- The Australian Steaming Coal Forecast in USD/t.

These coal prices are referred to as the benchmark coal prices for coking coal and steaming coal. The benchmark price reflects the specification of the benchmark coals being:

- Hard Coking Coal (PLV, FOB Hay Point) for coking coal; and
- Thermal Coal Newcastle (FOB 6000 kcal/kg NAR).

The consensus coal price view is produced in quarterly periods for 2 years and in calendar years for 6 years. The consensus forecasts are in nominal USD.

RPM has converted these nominal price forecast by calendar year into real price forecast by financial year. For years beyond 6 years the consensus view is provided in both nominal and real terms for the years 2020 – 2024. RPM has used the real price forecast for this period to apply to the financial year calendar of the model out to 2024.

As the economic model extends beyond 2024, RPM has extended the forecast price of 2024 to the last year 2042 as a constant price equal to the 2024 price.

The consensus price forecasts used in the economic model are outlined in Table 12-3.

Table 12-3 - Consensus Coal Price Forecasts (USD/t)

Fiscal Year	2015	2016	2017	2018	2019	2020	2021 - 2042
Coking Coal Benchmark Price	124.7	134.0	141.5	146.7	149.8	153.5	151.7
Energy Coal Benchmark Price	80.5	77.3	80.6	83.2	84.1	85.8	87.8

For the coal product sales in the economic model a discount to the benchmark coal price has been determined from historical sales and also confirmed by RPM from an examination and analysis of the specification of the coal being sold as indicated below.

- Domestic and export coking coal blend 100% of benchmark price
- Domestic and export coking coal - Bulli 97.6% of benchmark price
- Domestic and export coking coal - Wonga 96.6% of benchmark price
- Export energy coal 79.3% of benchmark price

Over the life of asset the coal sales by product type are outlined in Table 12-4.

Table 12-4 - Life of Asset Coal Sales

		Domestic	Export	Total
Coking Coal	Mt	44.2	105.5	149.7
Energy Coal	Mt		15.3	15.3
Total Coal Sales	Mt	44.2	120.8	165.0

The average coal prices realised for coal sales are outlined in Table 12-5. Over the life of asset the average realised coking price is USD 146.30/t compared to the average benchmark price over the period of USD 149.80/t. The average realised energy coal price over the life of asset period is USD 68.70/t compared to the average benchmark price over the period of USD 86.70/t.

The average realised coal price of combined coking coal and energy coal sales is USD 138.9/t.

Table 12-5 - Realised Coal Prices Estimate

		RPM Model Life of Mine	Benchmark
Coking Coal Sales	USD/t	146.30	149.80
Energy Coal Sales	USD/t	68.70	86.70
Average Coal Sales	USD/t	138.90	

The total amount of revenue generated in the model from coal sales is USD 22,873 M (AUD 27,193 M).

12.2.1 Operating Costs

The project operating costs are discussed in **Section 11.1** of the report. Over the LOM the total operating cost incurred is AUD 16,807 M at an average unit cost of AUD 102/t sales.

12.2.2 Capital costs and Depreciation

The project capital costs are discussed in **Section 11.2** of this report. Over the life of asset it is planned to spend a total of AUD 2,997 M on sustaining, development and growth capital.

The capital expenditure has been depreciated in the economic model in accordance with Australian tax legislation. Capital expenditure has been deducted as diminishing value depreciation over the life of the asset associated with the capital expenditure and allocated to the relevant depreciation pool. There are 14 pools established in the economic model to allocate capital, with depreciation periods ranging from life of asset to 2 years.

Existing tax written down values, as at 30 June 2014, are included in the economic model. The existing tax written down value is AUD 1,009 M.

Total deductions allowed for capital expenditure in the economic model is AUD 3,691 M.

12.2.3 Levies and Royalties

Levies that have been allowed in the economic model relate to:

- Coal research levy for ACARP at the rate of AUD 0.05/t sales. RPM confirms the applicability of this rate; and
- Coal mining waste levy which applies to coal refuse or reject from the DCPD which are disposed of in the West Cliff waste emplacement area. The levy is applied at the rate of AUD 13.68/t of refuse disposed. RPM confirms the applicability of this rate.

Total levies over the life of asset are AUD 91 M.

Royalty is payable to the NSW State Government on the proceeds of underground coal mining. The royalty is based on a percentage of revenue with allowable deductions for the ACARP levy and for coal processing costs. The Royalty rate applicable for underground coal mining in NSW is 7.2% where the depth of cover of the underground mine is less than 400 m and 6.2% where the depth of cover of the underground mine is greater than 400 m.

The net royalty base for the Coal Reserve is AUD 26,579 M and the royalty payable is AUD 1,695 M or AUD 10.30/t sales. The effective royalty for the reserves taking account of depth of cover is 6.39%

Total royalties and levies amount to AUD 1,786 M.

12.2.4 Assessable Income and taxation

The assessable income for income tax assessment is total revenue minus cost of goods sold, minus deductions for capital expenditure in real terms and minus royalty and levies.

The assessable income is AUD 5,005 M.

The company tax rate that is applied to the assessable income is 30%. The tax liability is AUD 1,502 M.

12.2.5 Discount Rate Estimation

For this Project, RPM has selected a discount rate of 10%. A Weighted Average Cost of Capital of 9% was derived using BHP Billiton's financing ratio and a mining sector beta. This was further increased to a 10% discount rate to allow for risks attached to an underground mining business.

12.2.6 Cash flow and NPV

The unleveraged free cash flow stream in the economic model is then converted to USD and discounted at 10%.

The estimated NPV of the Coal Reserves is USD 1,517 M.

This valuation is reflective of Illawarra Coal, based on our view of the Coal Reserves only (as forecast as at 31st December 2014). It is important to emphasise that this value does not represent the value of the Coal Reserves in the ground in isolation, but rather, incorporates the value of all of ungeared net assets contributing to the project based on a life of asset Coal Reserves production profile.

13 Risks & Opportunities

13.1 Opportunity

RPM considers that there are a number of viable improvement opportunities that have potential benefits to the Illawarra Coal business. These include:

- **Increased weekly longwall and development operating hours and rate:** For the equipment and infrastructure invested and in place at the Appin, West Cliff and Dendrobium Mines, a concerted and sustained effort to further increase weekly production hours and production rate may lift potential annual sales, reduce the amount of development hours required to meet annual longwall continuity and lower operating costs through increased production and/or less development units and/or the redeployment of people onto other essential supporting work. This latter outcome would allow a reduction in the size of the workforce lowering costs.
- **Rationalise Group Engineering Functions:** Current engineering standards are very high with some apparent high levels of redundancy and engineering input and support. Opportunity exists to review group engineering functions to reduce their cost base and also reduce capital spend and ongoing maintenance costs. One potential area is to draw down on the available spare equipment. Tighter control of engineering standards and re-use of existing equipment may assist in reducing future capital expenditure requirements.
- **Sell Redundant Assets:** Identify non-core assets, functions and services and determine their optimum value to the ongoing business. Consideration should extend to outsourcing services and functions.
- **Reduce Sustaining Capital Expenditure:** There is an estimated AUD 151 M for sustaining capital expenditure over the last five years of mining operations. There is an opportunity to reduce this amount of sustaining capital expenditure as the mines approach the end of their coal production.
- **Project Cost Saving Initiatives:** Illawarra Coal has been implementing a broad Project cost reduction initiative over the past 6 months. A range of cost savings have been identified and programmes are being implemented to achieve these. On average, Illawarra Coal has identified AUD 85 M of cost savings per year over the remaining life of asset, of which RPM has recognised on average AUD 50 M of savings per year in the valuation.
- **Coal Reserve Expansion:** There are opportunities to potentially expand the area of Coal Reserves at Illawarra Coal. Each opportunity requires additional exploration, feasibility studies and receipt of additional licences and approvals before the opportunity has the potential to be realised.
 - Illawarra Coal holds exploration title over Appin Area 10 but do not have operating approvals or Development Consent. Appin Area 10 is located northwest of Areas 7 and 9.
 - The Wongawilli Seam in the vicinity of the Cordeaux Mine. Additional feasibility studies are required to determine the potential economics of this area.
- **Execute the Appin Coal Clearance Project:** Implement the replacement of the ageing coal clearance infrastructure at the pit bottom and coal clearance drift area of Appin Mine as well de-bottleneck other parts of the BSO coal clearance system. Will result in higher production utilisation and lower operating costs.
- **New Mining Systems for Panel Development:** Significant Research and Development work has been completed by the Industry in NSW and Qld to re-engineer the extremely mature but low productivity panel development systems employed at each longwall mine. Work has

progressed to the extent that investment in finalising the design, development and implementation of this new multi-faceted system could occur in the next few years. As the Appin Mine is forecast to use up to seven development units at times over its life of mine plan, any increases to development rates or costs may provide a significant productivity, operating cost and sustaining capital cost improvement to the operation.

13.2 Risk

Mining is a relatively high risk business when compared to other industrial and commercial operations. Each business, mining operation and related support and/or downstream services or functions have unique characteristics relating to risk and opportunity that may be identified from the information available.

RPM has identified risks within the business and operations of Illawarra Coal. These risks along with potential broad controls are described in Table 13-2.

The risks are ranked as **High**, **Medium** or **Low**, and are determined by assessing the perceived consequence of a risk and its likelihood of occurring using the following definitions. The risk rating is after the implementation of the mitigating factors.

Consequence of risk:

- **Major:** the factor poses an immediate danger of a failure, which if uncorrected, will have a material effect (>15% to 20%) on the Mine cash flow and performance and could potentially lead to Mine failure;
- **Moderate:** the factor, if uncorrected, could have a significant effect (10% to 15% or 20%) on the Mine cash flow and performance unless mitigated by some corrective action, and
- **Minor:** the factor, if uncorrected, will have little or no effect (<10%) on Mine cash flow and performance.

Likelihood of risk occurring within a 7 year timeframe:

- **Likely:** will probably occur;
- **Possible:** may occur, and
- **Unlikely:** unlikely to occur.

The consequence of a risk and its likelihood of occurring are then combined into an overall risk assessment as shown in Table 13-1 to determine the overall risk rank.

Table 13-1 - Risk Assessment Ranking

Likelihood	Consequence		
	Minor	Moderate	Major
Likely	Medium	High	High
Possible	Low	Medium	High
Unlikely	Low	Low	Medium

RPM notes that in most instances, that through maintaining and/or implementing controls identified through detailed review of the business and mine's operations, existing documentation together with additional technical studies, many of the normally encountered risks may be mitigated.

Table 13-2 - Business and Mine Risk Assessment

Risk Ranking	Risk Description and Suggested Further Review	Potential Mitigants	Area of Impact
M	BSO - Seam and Strata Gas Emissions	<p>Over 40 years' experience operating in a high gas environment. The technical knowledge and understanding of the gas reservoir in, above and below the Bulli Seam means management is well equipped to mitigate the impact on future production. Controls used to eliminate or at least mitigate these occurrences include continued seam gas reservoir testing and modeling to underpin the design and timely execution of an appropriate gas drainage drilling program.</p> <p>Use of an effective gas management strategy enabling high production.</p> <p>The gas management system includes management plans. These documented and audited plans are part of the controls for management of the risks associated with gas emissions initiated by mining activity. They set out the methods, procedures and technical standards that will be used to control the working environment over the range of gas conditions anticipated through the life of the asset.</p> <ul style="list-style-type: none"> ▪ Longwall Gas Management Plan, ▪ Ventilation & Monitoring Arrangements ▪ Outburst Management Plan 	<p>Failure to meet annual production budget resulting in higher costs, lower revenue and reduced profitability.</p>

- Gas Drainage Management Plan
- Frictional Ignition Procedure.

Weekly and monthly checks on the efficiency of gas drainage activities provide the opportunity to respond to emerging conditions and help reduce production delays. This results in a strong focus on reduction of gas delays to production.

Planned annual gas drainage costs and ventilation costs appear to be adequate to meet the requirements of budget production rates.

M Geotechnical Incidents Impact Production

Inability to manage and overcome regular geotechnical incidents relating to rib and roof stability in development and longwall mining could prevent operations from meeting their annual production budgets.

Inability to manage a potentially more aggressive operating environment associated with higher vertical stresses resulting from working at increased depth.

Illawarra Coal has been dealing pro-actively and usually successfully with these issues as and when they arise over many years. This risk is a greater concern at Dendrobium Mine due to the nature of the roof and floor strata.

Periodic and incident-triggered review of strata management plans to ensure the strata support system remains sufficient to manage the operating environment.

Geotechnical incidents not only impart a safety risk on the operation but also divert resources and management focus, and incur high costs associated with clean up and re-support. Significant incidents can impact on development and longwall production and prevent the mine from achieving budget output.

M Land Acquisition for BSO Ventilation Shaft(s)

Land required for future Ventilation Shaft(s) is not available or if acquired is not in the best location for optimising mine ventilation as a result of unsatisfactory landholder engagement.

Complete Technical studies to optimally locate future shaft(s). Early pro-active engagement with landholders.

Increased capital and operating costs

M Major Service Supplier Risk – Dendrobium Processing Plant

The services to the Dendrobium Processing Plant are provided by the BlueScope Steelworks. Loss of services from BlueScope Steel provided to Dendrobium Coal Preparation and Coal Handling Plant could affect production from Dendrobium.

Long-term lease of Coal Preparation Plant and other services in place.

Temporary reduction in production and revenue. Depending on preferred solution, increase in operating and/or capital cost.

L Typical Longwall Mining Risks

Further to the specific risks stated in this table, there are common risks to almost all underground longwall coal operations. These include:

- Explosion: the risk of seam gases underground falling in an explosive range and being ignited by spontaneous combustion or other ignition source.
- Fire: out of control fire affect a significant portion of the underground workings.
- Flooding or inrush from surface water bodies or aquifers.
- Major roof collapse in the maingate, tailgate or across the longwall face resulting in an extended halt to longwall operations.
- Excessive weight on the longwall and/or soft floor resulting in the longwall mining into the floor horizon.

Illawarra Coal has established operating procedures to address these risks which are inherent to underground longwall coal mining and have been dealing pro-actively and successfully with these issues as and when they arise over many years.

Any of these events may impact production, operating and capital costs.

L - M Project Cost Saving Initiatives

Illawarra Coal has implemented a range of Project cost saving initiatives over the past 6 months. RPM has included an average of AUD 50 M savings per year in the valuation model based on this initiative. Illawarra Coal may not achieve the full forecast cost savings.

This is currently being managed by a dedicated team based at the head office liaising with site general managers to ensure that project execution plans are developed for each initiative. Progress against plan is reported and managed at a high level in the organization.

Not achieve the forecast Project cost savings resulting in higher total costs.

L New Project Ownership and Management

Illawarra Coal has maintained a significant focus on de-risking the Project from a geological, engineering, operating and compliance perspective. As the Project seeks to achieve greater operating efficiencies and cost savings, some of which have been identified by RPM as opportunities, a balance between achieving a greater productivity and a lower cost base whilst maintaining high operating standards will need to be achieved.

Corporate and management focus on increasing Project efficiency whilst maintaining high operating and technical standards.

May potentially impact on many areas of the Project.

L Dendrobium Ventilation Requirements

A potential risk for Dendrobium is an increase in historical ventilation and gas drainage requirements from the past due to higher gas emissions. Also, if there is outburst risk, additional controls will need to be applied to development activities, and these may constrain performance and increase overall costs.

Work completed to date shows this is unlikely in Area 3B. Based on the current information, within Area 3B the reservoir characteristics are unlikely to contain any material risks to future production.

Consequently no significant additional investment is required for gas management apart from the application of natural mine ventilation methods.

Exploration work to date has indicated that Area 3C has a more aggressive gas environment than Dendrobium has experienced to date. This area is however outside of the reserve estimate and is not considered further in this review.

Slow down development and longwall production. Failure to meet annual production budget resulting in higher costs, lower revenue and reduced profitability.

L Environmental Impacts

Environmental and social management of the mining operations involve comprehensive technical assessment and monitoring of natural landscape features such as swamps, cliffs and streams especially areas of the Sydney drinking water catchment. In other areas, the management of the potential effects of mining on surface features relates to rural residences and related structures as well as major linear infrastructure such as pipelines, transmission lines, railway and major roads and their related structures such as embankments and bridges. Illawarra Coal demonstrates industry leading practice in monitoring and mitigation of mining impacts on major infrastructure.

The area of future mining exhibits surface environmental management constraints that are similar to those that have been successfully addressed to date.

Despite this, there remains a risk that unforeseen damage to surface environments (hydrogeological and/or high value ecological communities, or critical infrastructure) beyond that envisaged in existing technical assessments and approval conditions may impact Illawarra Coal's ability to implement their operations as currently forecast.

Close monitoring and review of environmental impact mitigation performance and implement adaptive management responses, including remedial work and possible modification to extraction plan

Surface environments above future longwall panels.

Potential impact on the ability to implement proposed life of asset operations.

L Carbon Pricing

The Australian Government revoked the carbon tax from 1 July 2014. Within the life of asset it is possible that a cost on carbon could potentially be imposed for carbon dioxide equivalent (CO₂-e) emissions from Illawarra Coal's coal mining operations (either by way of a tax, levy or the cost of tradable emission certificates).

Nil

Project costs and operating margins.

The detail of any such potential costs cannot be foreseen and could be dependent on both domestic and international factors. It is notable that such a cost imposition would be part of a broad-based policy regime that would also affect other Australian coal operations in a manner commensurate with their emissions profile.

A1. Annexure A – Qualifications and Experience

David McMillan - Master of Engineering - Royal School of Mines - Imperial College, University of London - Executive Consultant RPM (Brisbane)

David's career spans twenty-three years, with over seventeen years of operational experience. He has extensive practical underground and open-cut coal experience working in operational, managerial and technical roles. David's operational experience extends over three continents and covers potash and coal mining. David has been with RPM for six years and currently holds the title of Executive Consultant. During this time he has lead teams in the delivery of major pre-feasibility and feasibility studies for underground coal operations in New South Wales and Queensland. He has also completed numerous technical reviews and mine optimisation studies.

David is a Competent Person for the estimation of Reserves in underground coal operations and is a Registered Professional Engineer of Queensland (RPEQ).

Greg Eisenmenger – Executive Consultant – Bachelor of Engineering (Civil) (Hons)

Greg has more than 35 years of international coal mining industry experience, with a strong technical and general management background. Greg's specific general management capabilities are drawn from involvement in the management of large mining contracts in open cut coal, management of in-house technical and engineering programs, management of the annual budgeting process for individual mine sites and the business unit level, and project development involving project definition, tendering, evaluation, award and construction supervision.

Greg is an Executive Consultant with RPM in the mining advisory space, managing coal mining project feasibility studies and undertaking independent technical reviews of mining assets being targeted by potential investors and completing valuations of coal projects.

Shaun Ayshford – Principal Resource Consultant – Bachelor of Science (Hons), C.Eng Mgmt

Shaun Ayshford is a geologist with 19 years' experience including 13 years' experience in the coal mining industry, on projects in Australia, Mongolia, South Africa, China, India and New Zealand. His experience ranges from exploration programs to geological modelling for open cut and underground coal mining projects.

He has built many JORC compliant geology models and geological databases, and compiled JORC Resource statements. A particular strength is his methodical approach to compliance auditing, due diligence and gap analyses for JORC and SAMREC resource estimates. Shaun has had several years' experience working in South Africa completing numerous SAMREC compliance audits for Anglo American since 2007. Shaun has also completed work within most of the NSW and Queensland coalfields, with hands on mining and exploration experience in the Hunter Valley.

Brendan Stats – Senior Resource Geologist, Bachelor of Science (Hons) Geology. MAusIMM, MAIG

Brendan is a Geologist with over ten years of experience in the mining industry. Brendan has a strong background in exploration, mine geology, coal quality and open cut geotechnical engineering.

Brendan has significant experience working for Rio Tinto in Australia on large open cut coal operations in Queensland and New South Wales. More recently Brendan has worked as a consultant providing services in geology, mine geology, exploration and civil projects. This work involved projects in Australia, Indonesia, South Africa, China, Mozambique and Mongolia.

Brendan has worked on mining projects from exploration, project evaluation to operating assets, as well as conducting resource estimate and reporting for listed companies.

With substantial experience in coal, Brendan meets the requirements for Qualified Person for NI 43-101 reporting and Competent Person for JORC reporting for most Coal Resources.

Lucy McMillan - Senior Processing Consultant - B. Eng. (Hons) Material Science and Engineering – Royal School of Mines- Imperial College University of London

Lucy McMillan is a metallurgist with 13 years of mineral processing and 5 years of consulting experience. Her background includes, capital and operational budget modelling, coal handling and prep plant production management, frontline supervision, plant commissioning and process optimisation in the U.K, South Africa and Australia.

Lucy's coal industry experience has included playing a key role in the development of strategic and operational plans. Building comprehensive operational and capital budgets and ensuring plant production, product quality, and budget targets were met. She has also played a leading role in the total overhaul and restructuring of existing processing plants. She has used her expertise to develop key performance indicators and improve systems used to predict and track yield and quality.

Lucy has practical experience in numerous aspects of mineral processing including dense medium separation, assessment of washability data, coal and potash flotation, on line sampling and analysis and discard disposal.

Ben Hall - Mining and Mechanical Engineer - Bachelor of Engineering (Mechanical), University of Queensland, Australia - Postgraduate Diploma of Engineering (Mining), University of Ballarat, Australia

Ben Hall is a mine maintenance and operations manager with 25 years of mining industry experience. His background includes frontline supervision, project engineering, training, maintenance planning, life cycle costing, fleet management and equipment utilization in both open-cut and underground environments across Australia. Industry sectors include coal, uranium, iron ore and base metals. Ben has developed the ability to recognize project intricacies, adapt and present innovative solutions.

As Executive Consultant with RungePincockMinarco, Ben has undertaken Feasibility Studies, Independent Technical Reviews, Expert Witness Services, Equipment selection & justification, provision of professional maintenance management advice to clients and presentation of training courses.

Prior to joining RPM, Ben held roles such as engineering manager, maintenance manager and superintendent of asset maintenance at numerous mining operations.

Peter Smith – Environmental Specialist, B.A. Environmental Science/Geomorphology/Land Management, Macquarie University; M.S. Environmental Studies, University of NSW; M.S. of Environmental Law, University of Sydney.

Peter has over thirty years' experience in Australia and overseas in environmental planning and management for mining operations, as well as for industrial and infrastructure developments. Peter's key strengths are in the provision of strategic advice to minerals industry Clients on sustainable environmental and community management, analysis and assessment of the compliance and performance of proposed and existing minerals industry operations and assisting in the development planning and approvals for new minerals industry operations.

Aaron Simonis – Bachelor of Engineering, Mining - University of Queensland, Masters of Engineering, Resource Economics - University of Queensland

With more than 15 years' experience acting in production, technical and management roles, Aaron possess wide ranging skills and expertise in the coal sector. His exposure to mining operations both in Australia, as well as internationally, provides him with a unique blend of experience across different open cut and underground mining methods, conditions and operational practices. Aaron has a strong background in project design and management as well as financial evaluation and mine planning. He is highly proficient in the use of geological modelling, mine planning, project management and financial evaluation software. Aaron possess

both undergraduate and postgraduate degrees in the fields of mine engineering and resource economics, respectively and is a Member of the AusIMM

Shoba Keys – Mine Gas Consultant –Bachelor of Engineering (Mining), UOW, Graduate Diploma Mine Ventilation (UNSW)

Shoba is a qualified Mining Engineer with more than 8 years underground coal mining and planning experience from the Illawarra region. Shoba worked underground as part of the production crews at Appin and Elouera collieries in development, longwall and gas drainage. During this time Shoba also was an appointed Control Officer and was part of the Mines Rescue brigade.

Shoba has also provided consulting services as a Geotechnical Engineer for mining and civil projects.

Shoba joined GeoGAS having previously worked with Illawarra Coal for a number of years on a project establishing a replacement mining area at Appin. This role involved ventilation, gas drainage and the mine production XPAC schedule for the Appin Area 9 project from existing mine requirements, transitioning through key ventilation milestones to life of mine.

Shoba has worked on a range of projects within GeoGAS including gas reservoir characterisation, development emission modelling and longwall emission modelling for single and multi -seam operations.

Shoba has a Graduate Diploma in Mine Ventilation from the University of NSW and a Ventilation Officers Certificate.

Dan Peel – General Manager - Bachelor of Engineering (Mining) – University of New South Wales, Unrestricted Quarry Manager (WA), Grad. Cert. Applied Finance - Kaplan, Diploma (Bus)

Dan is a mining engineer with industry experience ranging from mining contracting to technical consulting. Employed by RungePincockMinarco since 2007, Dan has specialised in strategic mine planning and technical due diligence studies. Dan has completed studies on numerous commodities including precious and base metals, iron ore and coal and has extensive working experience in Australia and Asia, where he was previously RPM's Operations Manager – Beijing office. Dan has been involved in numerous public reports prepared for the ASX, HKEx and TSX.

Prior to joining RPM, Dan worked with an open cut mining contracting firm where he gained significant open cut metal mining experience. Dan's operational roles included Quarry Manager of the BHP Billiton Jimblebar iron ore mine and Mining Superintendent of the Mt Gibson Koolan Island iron ore mine

Dan is a member of the Australian Institute of Mining and Metallurgy.

RPM Experience – Global Reports

RPM has significant experience in global stock exchange listings and transactions. Our company has completed Independent Technical Expert Reports for all major stock exchanges throughout the world. Below is a list of some of our significant transactions, with links to the circular documents, over the past 10 years which also presents the information regarding the sponsor and financial advisors.

Recent Major Mergers and Acquisitions

MMG Limited (30 June 2014)

Las Bambas Cu Mo Project, Peru, Competent Persons' Report
<http://www.hkexnews.hk/listedco/listconews/SEHK/2014/0630/LTN20140630228.PDF>

China Molybdenum Company Limited (6 November 2013)

Northparkes Au Cu Project, Central West NSW, Competent Persons' Report
www.hkexnews.hk/listedco/listconews/SEHK/2013/1106/LTN20131106492.pdf

Aston Resources Merger with Whitehaven Coal Limited Merger (ASX Code: WHC) (19 April 2012)

Scheme of Arrangement, Independent Technical Specialist Report
www.whitehavencoal.com.au/investors/documents/AstonSchemeBooklet_000.pdf

China Daye Non-Ferrous Metals Mining Ltd. (HKEx Code: 661) (8 March 2012)

Hubei Polymetallic Mine HKEx, Competent Persons' Report
www.hkexnews.hk/listedco/listconews/sehk/2012/0109/LTN20120109098.PDF

Initial Public Offerings

Huili Resources (Group) Ltd. IPO (HKEx Code: 1303) (12 January 2012) Xinjiang and Shanxi Polymetallic Mine HKEx Competent Persons' Report

www.hkexnews.hk/listedco/listconews/sehk/2012/0112/LTN20120112270.PDF

Glencore IPO LSE and HKEx (24 May 2011)

Mineral Experts Report – Colombian Coal Assets
www.hkexnews.hk/listedco/listconews/sehk/2011/0513/00805_1074520/EWPGLENCORE-20110511-41.pdf

China Polymetallic Mining Limited IPO (HKEx Code: 2133) (2 December 2011)

Yunnan Pb-Zn-Ag HKEx Competent Persons' Report
www.hkexnews.hk/listedco/listconews/sehk/2011/1214/LTN20111214250.PDF

FeOre Limited IPO (ASX: FEO) 1 November 2011

Independent Geologist's Report Ereeny Iron Project
www.hkexnews.hk/listedco/listconews/sehk/20110209/LTN20110209114.pdf

Aston Resources IPO (ASX: AZT) (6 August 2010)

Independent Technical Experts Report, Mules Creek Coal Project
www.whitehavencoal.com.au/investors/documents_astonasx/2010%20ASX%20ANOUNCE_PDF/August%202010/Replacement%20Prospectus.pdf

Perseus Mining Limited (TSX: (30th November, 2009)

Technical Report, Central Ashanti Gold project, Ghana (Technical report in support of IPO Prospectus)
http://sedar.com/GetFile.do?lang=EN&docClass=24&issuerNo=00029380&fileName=/csfsprod/data103/filings/01519387/00000002/c%3A%5CPerseus%5CPer_Tech_Rpt_C_Ashanti.pdf

Metallurgical Corporation of China Ltd. (HKEx Code: 1618) (11 September 2009)

Global Mining Assets Independent Technical Review
www.hkexnews.hk/listedco/listconews/SEHK/2009/0911/01618_632658/E133.pdf

Whitehaven Coal IPO (ASX: WHC) (June 2007)

Independent Technical Experts Report
www.whitehavencoal.com.au/investors/documents/Whitehaven_Coal_Limited_Prospectus_May2007.pdf

Xstrata IPO on LSE (June 2003)

A2. Annexure B – Glossary of Terms

ACCP - the Appin Coal Clearance Project.

Adit - a nearly horizontal passage from the surface by which a mine is entered and dewatered. A blind horizontal opening into a mountain, with only one entrance.

Angle of Dip - the angle at which strata or mineral deposits are inclined to the horizontal plane. In most localities, earth movements subsequent to deposition of the strata have caused them to be inclined or folded.

Aquifer - a bed of rock strata that contains water.

Armoured face conveyor (AFC) - an articulated chain conveyor that transports the coal along the longwall face after it has been cut by the coal shearer.

Ash - Inorganic residue after incineration of coal.

Ash Analysis - Expresses the composition of ash in terms of its oxides.

Auxiliary Fan - used in conjunction with air ducting to the direct portion of the main ventilating current to the working face.

BlueScope - BlueScope Steel steelworks site at Port Kembla.

Booster Fan - an underground installation of secondary fan(s) to assist the main fan(s) ventilating the mine.

Borehole - any deep or long drill-hole, usually associated with a diamond drill.

Brushing - digging up the bottom or taking down the top to give more headroom in roadways.

BSL - (Beam Stage Loader) A part of the longwall face equipment. Redirects the coal from the AFC through 90° to align the coal flow with the conveyor belt. Moves forward with the longwall face and forms the bridge between the moving face equipment and the fixed gate conveyor.

BSO - Bulli Seam Operation (West Cliff and Appin).

CHPP - Coal Handling Preparation Plant

Coal Handling Preparation Plant - A plant used to upgrade the quality of coal including crushing, sizing and drying.

Coal Reserves - see note below

Coal Washing - the process of separating undesirable materials from coal based on differences in densities.

Coking Coal - coal that is suitable to be used to produce coke.

Collar - the term applied to the timbering or concrete around the mouth or top of a shaft. The beginning point of a shaft or drill hole at the surface.

Continuous Miner - a machine that simultaneously extracts and loads coal / rock. This is to be distinguished from cyclic unit which must stop the extraction process in order for loading to commence.

CSN - Crucible Swelling Number.

DCPP - Dendrobium Coal Processing Plant.

Depth - the word alone generally denotes vertical depth below the surface. In the case of incline shafts and boreholes it may mean the distance reached from the beginning of the shaft or hole, the borehole depth, or the inclined depth.

Development mining - work undertaken to open up an area of an underground mine as distinguished from the work of actual mineral extraction.

Dilution - waste material adjacent to the coal seam which is 'unavoidably' mined with the coal.

Dip - the inclination of a geologic structure (bed, vein, fault, etc.) from the horizontal; dip is always measured downwards at right angles to the strike.

Downcast shaft - shaft or other mine opening which carries fresh air from the surface down to the mine workings.

Drift - a sloped entry passage into a coal mine. Drifts may start at the surface and lead to the coal seam, or be between seams in a mine.

Dyke - an intrusive igneous body which has disrupted the coal seam by cutting through it. Usually it has a sintered band of coal each side of the rock.

Energy Coal - coal used to provide heat for steam raising as part of the electricity generation process.

Fault - a slip-surface between two portions of the earth's surface that have moved relative to each other.

Fault Zone - a fault, instead of being a single clean fracture, may be a zone hundreds or thousands of metres wide. The fault zone consists of numerous interlacing small faults or a confused zone of gouge, breccia, or mylonite.

Feed - material (coal and waste) fed into the processing plant.

Feeder - a machine that feeds coal onto a conveyor belt evenly.

Fixed carbon - the part of the carbon that remains behind when coal is heated in a closed vessel until all of the volatile matter is driven off.

Flotation - wet process for the separation of coal from waste rock. The coal particles are lifted or floated to the surface by air bubbles in a liquid medium.

Floor Heave - the process of the floor of a mine beginning to lift as a result of high ground stresses.

Fluidity - the degree to which coal becomes plastic over certain temperature ranges during the carbonisation process. The measurement of "maximum fluidity" is used by some steel makers in assessing the ability of coal particles to mix with other coals in a coke oven blend. Maximum fluidity is determined by placing a sample of finely ground coal in a crucible and measuring the speed of rotation of a paddle placed within the crucible which is heated. A gravitational force is applied to the paddle and the maximum rotation of the paddle is measured to dial divisions per minute or DDPM. The temperature at which the paddle reaches maximum rotation differs for varying coal types.

Formation - any assemblage of rocks which have some character in common, whether of origin, age, or composition. Often, the word is loosely used to indicate anything that has been formed or brought into its present shape.

Frictional Ignition - caused when a blunt tool - cutter pick strikes an object or quartz bearing strata and creates a spark that is hot enough to ignite the methane.

FYxx- financial year, with xx referring to the last 2 digits of the financial year, which runs from 1/7/(xx-1) to 30/6/xx.

Gas Drainage - a process whereby a series of holes are drilled into a known gassy area, then suction is applied to the holes to draw out/dilute the gas content of the coal linked to outburst management.

Gateroad Panel Roadway - a roadway that provides access to a working panel.

GBIS - software provided by Micromine.

Goaf - the area abandoned and left to collapse after the extraction of coal - an acronym for Ground Opposite Advancing Face

Hydrocarbon - a family of chemical compounds containing carbon and hydrogen atoms in various combinations, found especially in fossil fuels.

Inbye - in the direction of the working face / ventilation.

Indicated Resources - see note below.

Inferred Resources - see note below.

In situ - in the natural or original position. Applied to a rock, soil, or fossil when occurring in the situation in which it was originally formed or deposited.

In situ density - the density of the material while it is in the ground.

Immediate Roof - the roof strata immediately above the coal bed, requiring support during the excavation of coal.

ISG - Integrated Survey Grid - a system adopted by NSW in the 1970's.

Joint - a divisional plane or surface that divides a rock and along which there has been no visible movement parallel to the plane or surface.

ktpw - thousand tonnes per week.

ktpa - thousand tonnes per year.

Lithology - the character of a rock described in terms of its structure, colour, mineral composition, grain size, and arrangement of its component parts; all those visible features that in the aggregate impart individuality of the rock. Lithology is the basis of correlation in coal mines and commonly is reliable over a distance of a few miles.

Longwall #1 - Appin Area 7.

Longwall #2 - West Cliff, moving to Appin Area 9, then moving to Appin Area 8.

Longwall #3 - Dendrobium.

Longwall Mining - one of two major underground coal mining methods currently in use. Employs a shearer and rotating cutting drums, which moves mechanically back and forth across a face of coal that is usually several hundred metres long. The loosened coal falls onto a conveyor for removal from the mine.

LWxx - Name of a longwall panel at a site, where xx is replaced by relevant numbers.

Methane - a potentially explosive gas formed naturally from the decay of vegetative matter, similar to that which formed coal. Methane, which is the principal component of natural gas, is frequently encountered in underground coal mining operations and is kept within safe limits through the use of extensive mine ventilation systems.

Measured Resources - See note below.

MGA - Map Grid of Australia - grid system currently adopted by all states in Australia.

MRD - Medium Radius Drilling - technique of drilling from the surface down to, and then along the coal seam.

MSB - Mine Subsidence Board.

Mt - million metric tonnes.

Outburst - a sudden release of gas/coal/rock due to elevated pressures. Strict controls required for drainage/approaching outburst risk zones.

Outbye - nearer to the mine entrance(s), and hence farther from the working face. Against the fresh air flow. The opposite of inbye typical statement is 'on the outbye side of something'

Panel - a coal mining block that generally comprises one operating unit. Can be continuous miners or longwall.

Parting - a layer of rock in a coal seam.

Pillar - an area of coal left to support the overlying strata in a mine; sometimes left permanently to support surface structures.

PKCT - Port Kembla Coal Terminal.

Preparation plant - a place where coal is cleaned, sized, and prepared for market. Also known as a wash plant or CHPP.

Product - coal product produced by the processing plant.

Proximate analysis - a physical, or non-chemical, test of the constitution of coal. Not precise, but very useful for determining the commercial value. Using the same sample (1 gram) under controlled heating at fixed temperatures and time periods, moisture, volatile matter, fixed carbon and ash content are successfully determined. Sulphur and Thermal Energy content are also generally reported with a proximate analysis.

Ranks of Coal - the classification of coal by degree of hardness, moisture and heat content.

Recovery - the comparison of what is actually recovered versus what was planned to be recovered. Expressed as a percentage can be either a mining recovery or a metallurgical recovery.

Reserve - see note below.

Resources - see note below.

Rib - the side of a pillar or the wall of an entry. The solid coal on the side of any underground passage. Same as rib pillar.

Roof - the overhead surface of a coal working place.

Roof Stress - unbalanced internal forces in the roof or sides, created when coal is extracted.

Royalty - the payment of a certain stipulated sum on the mineral produced.

Run-of-Mine (ROM) - raw material as it exists in the mine; average grade or quality.

Sales - coal product sold to a customer.

Sandstone - a sedimentary rock consisting of quartz sand united by some cementing material, such as iron oxide or calcium carbonate.

SCADA – Supervisory Control and Data Acquisition. A system used to monitor the underground environment.

Schedule - plan of future events. Usually numeric.

Seam - a stratum or bed of coal.

Secondary roof - the roof strata immediately above the coal seam, requiring support during the excavating of coal.

Shaft - a primary vertical or non-vertical opening through mine strata used for ventilation or drainage and/or for hoisting of personnel or materials; connects the surface with underground workings. Shafts can also connect sub-surface workings from one level to another. Therefore providing storage capacity.

Shale - a rock formed by consolidation of clay, mud, or silt, having a laminated structure and composed of minerals essentially unaltered since deposition.

Shearer - a mining machine for longwall faces that uses a rotating action to cut the material from the face as it progresses along the face.

Shift - the number of hours or the part of any day worked.

Shuttle Car - a self-discharging truck, generally with rubber tires or caterpillar-type treads, used for receiving coal from the loading or mining machine and transferring it to an underground loading point, mine railway or belt conveyor system.

Specific Energy - the energy in kilocalories or gigajoules released per kilogram of coal burned.

Steaming Coal - coal used to provide heat for steam raising as part of the electricity generation process.

STIS - Surface To In-Seam drilling. Commonly referred to as SIS.

Stress - the sub-surface strata contains three types of stresses generally due to depth, nature of the strata and other geotechnical factors. Strata stresses can be vertical, horizontal (major/minor). Stresses are closely linked to strata support systems.

Strike - the direction of the line of intersection of a bed or vein with the horizontal plane. The strike of a bed is the direction of a straight line that connects two points of equal elevation on the bed.

Subsidence - the gradual sinking, or sometimes abrupt collapse, of the rock and soil layers into an underground mine. Structures and surface features above the subsidence area can be affected.

Support - the all-important function of keeping the mine workings open. As a verb, it refers to this function; as a noun it refers to all the equipment and materials--timber, roof bolts, concrete, steel, etc.--that are used to carry out this function.

Syncline - a fold in rock in which the strata dips downward from both sides toward the axis. The opposite of anticline.

Tailgate - a subsidiary gate road to a conveyor face as opposed to a main gate. The tailgate commonly acts as the return ventilation and second means of egress airway

Thermal Coal - coal which is normally used for the generation of heat for steam raising and other general industry applications.

Ton - a short or net ton is equal to 2,000 pounds; a long or British ton is 2,240 pounds; a metric tonne is approximately 2,205 pounds.

tph - tonnes per hour.

tpw - tonnes per week.

Ultimate Analysis - precise determination, by chemical means, of the elements and compounds in coal.

Upcast Shaft - a shaft through which air leaves the mine. Usually contains gases/dust/moisture heat.

Ventilation - the provision, by means of fans, of a directed flow of fresh and return air along all underground roadways, traveling roads, workings, and service parts.

Volatile Matter - the percentage of coal which is lost as gases which coal is incinerated under standard conditions. Mostly hydrocarbons of coal.

WCCPP - West Cliff Coal Processing Plant.

Workings - the entire system of openings in a mine for the purpose of exploitation.

Working Section - the working section is the physical area of the mine where mining activities are currently taking place. For example, in an open-pit coal mine, the working section is the area between the Coal face and the point where the Trucks depart with their loads. In an Underground Coal mine, the Working Section is the area between the face and the point where the Coal is loaded onto belts or rail cars.

Note: Where the following terms are used in this report, they have the same meaning as defined in The Australasian Code for Reporting of Exploration Results, Mineral Resources and Ore Reserves (JORC Code).

A '**Mineral Resource**' is a concentration or occurrence of solid material of economic interest in or on the Earth's crust in such form, grade (or quality), and quantity that there are reasonable prospects for eventual economic extraction. The location, quantity, grade (or quality), continuity and other geological characteristics of a Mineral Resource are known, estimated or interpreted from specific geological evidence and knowledge, including sampling. Mineral Resources are sub-divided, in order of increasing geological confidence, into Inferred, Indicated and Measured categories. An 'Ore Reserve' is the economically mineable part of a Measured and/or Indicated Mineral Resource. It includes diluting materials and allowances for losses, which may occur when the material is mined or extracted and is defined by studies at Pre-Feasibility or Feasibility level as appropriate that include application of Modifying Factors. Such studies demonstrate that, at the time of reporting, extraction could reasonably be justified.

A '**Measured Mineral Resource**' is that part of a Mineral Resource for which quantity, grade (or quality), densities, shape, and physical characteristics are estimated with confidence sufficient to allow the application of Modifying Factors to support detailed mine planning and final evaluation of the economic viability of the deposit. Geological evidence is derived from detailed and reliable exploration, sampling and testing gathered through appropriate techniques from locations such as outcrops, trenches, pits, workings and drill holes, and is sufficient to confirm geological and grade (or quality) continuity between points of observation where data and samples are gathered.

A Measured Mineral Resource has a higher level of confidence than that applying to either an Indicated Mineral Resource or an Inferred Mineral Resource. It may be converted to a Proved Ore Reserve or under certain circumstances to a Probable Ore Reserve.

An '**Indicated Mineral Resource**' is that part of a Mineral Resource for which quantity, grade (or quality), densities, shape and physical characteristics are estimated with sufficient confidence to allow the application of Modifying Factors in sufficient detail to support mine planning and evaluation of the economic viability of the deposit. Geological evidence is derived from adequately detailed and reliable exploration, sampling and testing gathered through appropriate techniques from locations such as outcrops, trenches, pits, workings and drill holes, and is sufficient to assume geological and grade (or quality) continuity between points of observation where data and samples are gathered.

An Indicated Mineral Resource has a lower level of confidence than that applying to a Measured Mineral Resource and may only be converted to a Probable Ore Reserve.

An '**Inferred Mineral Resource**' is that part of a Mineral Resource for which quantity and grade (or quality) are estimated on the basis of limited geological evidence and sampling. Geological evidence is sufficient to imply

but not verify geological and grade (or quality) continuity. It is based on exploration, sampling and testing information gathered through appropriate techniques from locations such as outcrops, trenches, pits, workings and drill holes.

An Inferred Mineral Resource has a lower level of confidence than that applying to an Indicated Mineral Resource and must not be converted to an Ore Reserve. It is reasonably expected that the majority of Inferred Mineral Resources could be upgraded to Indicated Mineral Resources with continued exploration.

An **'Ore Reserve'** is the economically mineable part of a Measured and/or Indicated Mineral Resource. It includes diluting materials and allowances for losses, which may occur when the material is mined or extracted and is defined by studies at Pre-Feasibility or Feasibility level as appropriate that include application of Modifying Factors. Such studies demonstrate that, at the time of reporting, extraction could reasonably be justified. The reference point at which Reserves are defined, usually the point where the ore is delivered to the processing plant, must be stated. It is important that, in all situations where the reference point is different, such as for a saleable product, a clarifying statement is included to ensure that the reader is fully informed as to what is being reported.

A **'Proved Ore Reserve'** is the economically mineable part of a Measured Mineral Resource. A Proved Ore Reserve implies a high degree of confidence in the Modifying Factors.

A **'Probable Ore Reserve'** is the economically mineable part of an Indicated, and in some circumstances, a Measured Mineral Resource. The confidence in the Modifying Factors applying to a Probable Ore Reserve is lower than that applying to a Proved Ore Reserve.

'Coal Resource(s)' and 'Coal Reserve(s)' - The terms 'Mineral Resource(s)' and 'Ore Reserve(s)', and the subdivisions of these as defined above, apply also to coal reporting, but if preferred by the reporting company, the terms 'Coal Resource(s)' and 'Coal Reserve(s)' and the appropriate subdivisions may be substituted.

A3. Annexure C - Licences and Approvals

Bulli Seam Operations: Key Mining Tenements, Approvals and Permits

Tenement/Permit	Number	Issue Date	Expiry Date	Area	Title Holder
Coal Lease	388	22.1.1992	22.1.2034	47.2 ha	Endeavour Coal Pty Ltd (ECPL)
Mining Lease	1382	20.12.1995	19.12.2016	1.18 ha	ECPL
Mining Lease	1433	24.7.1998	23.7.2019	65.0 ha	ECPL
Mining Lease	1574	9.7.2008	30.13.2023	419.40 ha	ECPL
Mining Lease	1678	26.6.1014	20.6.2035	1,277.0 ha	ECPL
Consolidated Coal Lease	724	4.7.1991	18.12.2031	3,721.0 ha	ECPL
Consolidated Coal Lease	767	29.10.1991	8.7.2029*	207.8 km ²	ECPL
Coal Lease	381	24.10.1991	24.10.2033	58.0 ha	ECPL
Mining Purposes Lease	200	13.1.1982	13.1.2024	5,706.0 ha	EPCL
<u>Exploration Licences</u>					
Authorisation	432	12.2.1991	**Awaiting Renewal	3,306.0 ha	ECPL
Authorisation (Area 7, Appin & West Cliff)	199	23.6.1980	**27.6.2014	1,072.0 ha	Illawarra Coal Holdings Pty Ltd (ICHPL)
Authorisation (Area 3 & Appin)	201	28.6.1980	**27.6.2014	484.0 ha	ECPL
Authorisation (Area 3)	306	19.7.1983	**27.6.2014	2,910.0 ha	ECPL
Authorisation (Area 3, 7, 8, Appin)	312	10.8.1983	10.8.2018	2,910.0 ha	ECPL
Authorisation (Area 3 & Appin)	370	8.5.1986	**27.6.2014	3,129.0 ha	ECPL
Authorisation (Area 3 & Appin)	395	23.11.1987	10.8.2018		EPCL
Authorisation (Area 7, 8, 9, Appin & West Cliff)	396	28.6.1988	**27.6.2014	7,225 ha	ECPL
Authorisation (Appin & West Cliff)	397	4.8.1987	**27.6.2014	407.0 ha	ECPL
Authorisation (Area 7, 9, West Cliff & MacArthur)	248	13.5.1981	19.12.2015	5,592.0 ha	ICHPL
Exploration Licence (Area 7 & MacArthur)	4470	5.1.1993	19.12.2015	4,845.0 ha	ICHPL
Exploration Licence (West Cliff)	7249	29.11.2008	25.11.2014	31.5 ha	ICHPL
<u>Key Environmental Approvals</u>					
Appin Gas Drainage Project - Initial	08_0256	2.10.2009	Extraction Wells 15.2.2019	--	ICHPL
Appin Gas Drainage Project - 2010 (Area 7)	08_0256 MOD1	3.12.2010	Extraction Wells 15.2.2019	--	ICHPL
Appin Gas Drainage Project - 2012	08_0256 MOD2	15.2.2012	Drilling 15.2.2017 Extraction Wells 15.2.2019	--	ICHPL
Bulli Seam Operations (BSO) Project Approval (NSW Govt)	08_0150	22.11.2011	31.12.2041	--	ICHPL
BSO Approval (C'th Govt)	EPBC 2010/5350	15.5.2012	15.5.2042	--	ICHPL
No.6 Ventilation Shaft Project Approval (NSW)	10_0079	4.5.2011	4.5.2041	--	ICHPL
No.6 Ventilation Shaft Project Approval (C'th)	EPBC 2010/5722	1.4.2011	1.4.2041	--	ICHPL
Environment Protection Licence (EPL)	2504	--	--	--	ECPL
NSW Office of Water Licences	10WA117285	15.11.2011	--	--	
SMP Approval, DRE	13/1879 OUT14/9467	28.3.2014	31.3.2021	West Cliff Area 5, Longwalls 37 & 38	ICHPL
Extraction Plan Approval, DP&E	re MP08_0150	10.9.14	--	Appin Area 9: LW 901-904	ICHPL

** Awaiting Renewal

Other development consents and modifications relevant to the main BSO approval relate to a range of infrastructure:

- Douglas North Substation Project (Part3A)
- Water Supply Pipeline Project (Part3A)
- East Appin Switching Station Project (Part3A)
- West Cliff Goaf Gas Drainage Project (Part3A)
- West Cliff Fuel Facility Project (Part3A)
- West Cliff Coal Preparation Plant Project (Part3A)
- Appin Gas Drainage Project (Part3A)
- West Cliff Goaf Gas Drainage Project Modification 1 - Longwall 34 (Part3AMod)
- Appin Ventilation Shaft No. 6 Project (Part3A)
- Appin Gas Drainage Project - s75W Mod 1 (Part3AMod)
- West Cliff Goaf Gas Drainage Project Modification 2 - Longwall 34 (Part3AMod)
- West Cliff Goaf Gas Drainage Project Modification 3 - Longwall 35 (Part3AMod), and
- Appin Gas Drainage Project Modification 2 (Part3AMod)

Dendrobium: Key Mining Tenements, Approvals and Permits

Tenement/Permit	Number	Issue Date	Expiry Date	Area	Title Holder
Mining Lease	1510	24.4.2002	23.4.2023	44.03 ha	Dendrobium Coal Pty Ltd (DCPL)
Consolidated Coal Lease (comprises original Cordeaux MLs 25, 28, 23, 30, 24, Lease No.66 portion D1106)	768	29.12.2001	**18.10.2010	185.6 ha	ICHPL
Mining Lease	1566	7.9.2005	7.9.2025	5.26 ha	DCPL
<u>Key Environmental Approvals</u>					
Development Consent	DA 60-03-2001	20.11.2002	21.12.2023	--	ICHPL
Consent Modification	MOD 11-2-2001	28.2.2002	21.12.2023	--	ICHPL
Consent Modification	MOD 36-5-2002-1	15.8.2002	21.12.2023	--	ICHPL
Consent Modification	60-03-2001 MOD3	28.8.2003	21.12.2023	--	ICHPL
Consent Modification	60-03-2001 MOD4	5.4.2006	21.12.2023	--	ICHPL
Consent Modification	60-03-2001 MOD5	30.11.2006	21.12.2023	--	ICHPL
Consent Modification	60-03-2001 MOD6	8.12.2008	21.12.2030	--	ICHPL
Environment Protection Licence (EPL)	3241	August 2000	--	1 July anniversary date	DCPL
EPL (Cordeaux)	611	December 1999	--	1 November anniversary date	ECPL
Water Access Licence (NSW Office of Water)	10WA118772	1.7.2013	27.6.2018	--	
SMP Approval - Longwalls 6-8 and 19	S03/01444	28.6.2010	--	--	ICHPL
SMP Approval - Longwalls 9-13	DGTO13/42	6.2.2013	--	--	ICHPL

END OF REPORT

This page has been intentionally left blank.

ANNEXURE 6

INDEPENDENT COMPETENT PERSONS' REPORTS

4. Groote Eylandt Manganese Mine – CSA Global
-

This page has been intentionally left blank.



Date: 5 March 2015
Report No: R288.2014

Competent Person Report

BHP BILLITON - GEMCO

Groote Eylandt Manganese Mine

Australia

by
Dr Bill Shaw
FAusIMM, CPGeo, FAIG, RPGeo

Paddy Reidy
MAusIMM

Valuation effective date: 31 December 2014

For:

BHP Billiton and South32 Limited
171 Collins Street
Melbourne VIC 3000
Australia

Approved:

Electronic signature not for duplication. Electronic signature not for duplication. Electronic signature not for duplication. Electronic signature not for duplication. Electronic signature not for duplication. Electronic signature not for duplication. Electronic signature not for duplication. Electronic signature not for duplication. Electronic signature not for duplication. Electronic signature not for duplication.

J Elliott, Managing Director



Executive Summary

Introduction

This Competent Person Report (CPR) was prepared by CSA Global Pty Ltd (CSA Global) between October and December 2014 for BHP Billiton and South32 Limited on the Manganese Australia Asset held by Groote Eylandt Mining Company Pty Ltd (GEMCO). CSA Global makes the following findings for the manganese Ore Reserves on Groote Eylandt which comprise the GEMCO Asset.

There are no material flaws in the technical aspects examined by CSA Global and documented in this CPR. Appropriate technical information was provided for review and it was considered to be reasonable and sufficient.

Social Licence to Mine

Appropriate risk management procedures are in place to deal with environmental issues, including all aspects of the social licence to mine, although these can never be assured. There are no apparent issues that could materially impede production. CSA Global is advised that there are no material prosecutions pending.

Mineral Resources and Ore Reserves

BHP Billiton has prepared and documented their Mineral Resources and Ore Reserves using appropriate methodologies in Hope and Bryant (2014) and Hope (2014) collectively referred to as CP FY14 as at 30 June 2014, with Ore Reserves based on mine planning documented in BHP Billiton (2013) and referred to as the FY14 Life of Asset (LoA) plan.

GEMCO Mineral Resources depleted to 31 December 2014, using production until 31 October and forecast production in the subsequent two months, are reported for a minimum ore thickness of 1 m above a 40% Mn A Assay grade. The Grade and Yield represent the expected concentrator results for the washed product. The Mineral Resource estimate is provided below.

GEMCO Mine Mineral Resources depleted to 31 December 2014

JORC Code (2012) classification	Tonnage (Dry Mt)	Grade A Assay (Mn %)	Yield (%)
Measured	90.1	46.0	48
Indicated	46.3	43.6	47
Inferred	33.5	42.7	49
Total	169.9	44.7	48

A small Mineral Resource of 15.0 Mt with an *in situ* grade of 20.7% Mn has been defined by the Sand Tailings Project. With further test work and the demonstration that the bulk sample

has produced a saleable product it is likely that the Mineral Resources for the Sand Tailings will be defined as an Ore Reserve in future. It is not considered in the Valuation of Ore Reserves by CSA Global.

The Mineral Resource and Ore Reserve estimates for GEMCO's manganese mine at Groote Eylandt have been examined and validated by CSA Global under the JORC Code (2012). The Ore Reserves declared by GEMCO are accepted by CSA Global as a reasonable basis for depletion to 31 December 2014. The accepted Proved Ore Reserve was depleted, using production up to 31 October 2014 and forecast production to 31 December 2014, by a total of 4.56 Mt at 47.2% Mn. The Ore Reserves as depleted by CSA Global are provided below.

**GEMCO Ore Reserves at 31 December 2014
after depletion of production since 30 June 2014**

JORC Code (2012) classification	GEMCO Ore Reserves		
	Tonnes (Dry Mt)	Mn (%)	Yield (%)
Proved Ore Reserve	73.7	44.9	58
Probable Ore Reserve	16.0	42.6	57
Total Ore Reserve	89.7	44.5	58

The operation has an appropriate level of geological understanding to support the mine planning process. Geotechnical understanding is appropriate for management of the shallow mining pits (Quarries). Assumptions are used in estimating the ore production volumes, including an allowance of 5% for mining loss. Dilution is not considered due to the visual controls on ore mining.

The mine has been successfully operating for 50 years and has seen a number of Concentrator and other infrastructure upgrades and de-bottlenecking. There is capacity to produce and supply appropriate volumes and quality of products to satisfy the markets at the forecast volumes.

A number of enhancements to the Mineral Resource and Ore Reserve estimation process are currently planned including: ongoing verification of the drilling results using industry standard quality control procedures; implementation of unfolding in the Mineral Resource modelling process; investigation of alternative Yield estimation methods and re-consideration of thin interburden (INT) horizons between the MID and BOT ore horizons. Reconciliation methods have not been sufficiently well-addressed in the past and a program to improve these and use them to enhance the prediction of Lump and Fines Yields is underway.

None of these issues are expected by CSA Global to have a material detrimental impact on the forecast Life of Asset, based on the Ore Reserves.

Risk Analysis

No material key risks were identified that are not already addressed by management in their risk assessments. Risks and Opportunities are discussed in Section 3.4.8. The risks GEMCO has identified and are addressing that impact on the Ore Reserves include:

- Tailings Storage Facility planning.
- Access to J deposit and Ndunga valley will require additional environmental and Traditional Owner approvals, which may reasonably be expected to be granted.
- Production of high grade Fines from G Quarry can cause stickiness handling problems during screening and transportable moisture limit handling problems. This material is planned to be mostly mined at the end of the Mine Life and/or blended during normal production. Recovery (Yield) factors have been reasonably allowed for in the LoA plan and Ore Reserves.

Valuation

Valuation of the Ore Reserves has been carried out by CSA Global under the VALMIN Code (2005).

The assumptions used in estimating operating costs, including mining, processing, product transport, and site administration are reasonable based on provided historical data and examination of financial forecasts as part of the Valuation work done for this CPR.

Capital costs used in the financial models are considered reasonable for the proposed mine plans, development and construction schedules and the forecast production levels. There are no major unauthorised capital expenditures required to deliver the Ore Reserves.

Using the key input assumptions described above as the Base Case, CSA Global has derived an ungeared, after-tax NPV of US\$1,721 million for 100% of the GEMCO Ore Reserves over the remaining mine life of 12.5 years from 31 Dec 2014 through 30 June 2027, the end of FY27.

CSA Global has determined a Valuation for the GEMCO Asset of BHP Billiton based upon the stated Ore Reserves at 31 December 2014. A range of sensitivities relating to commodity price, the A\$/US\$ exchange rate and discount rate were undertaken on the cash flow model. The Base Case Value determined by CSA Global for BHP Billiton's 60% share of the GEMCO Asset is US\$1,033 million. GEMCO's Groote Eylandt Mine has an expected mine life of 12.5 years to the end of FY27, i.e. 30 June 2027.

Taking into consideration the opportunities to realise value above that represented by the Base Case, CSA Global considers the Preferred Value lies between the Base Case and the upper limit of the range of sensitivity studies. The Market or Fair Value for 100% of the GEMCO Asset based on the Ore Reserves is expected to lie in the range from US\$1.7B to US\$2.3B, with a most likely value of US\$2.0B. BHP Billiton's 60% share is valued in the range from US\$1.0B to US\$1.4B with a most likely value of US\$1.2B.

ESMA Reporting Requirements

This Competent Person Report must comply with the rules and requirements of the Relevant Listing Authorities including, in the case of a UKLA listing, the European Securities and Markets Authority (ESMA)'s Recommendations on consistent implementation of Commission Regulation (EC) No 809/2004 implementing the Prospectus Directive. The following information is provided in compliance with ESMA Appendix II.

Clause iii) Resources and reserves:

(3) The Mineral Resources include the Ore Reserves.

(4) No supporting assumptions are used in ensuring that mineral resource statements are deemed to be 'potentially economically mineable'. The Asset is an operating mine and only Ore Reserves are valued.

(7) The Competent Persons for this CPR visited the GEMCO Asset on Groote Eylandt for one day on 4 November 2014.

Clause ix) In relation to special factors that require reporting: the monsoonal climate is addressed in Section 2.4 and traditional land ownership in Section 2.6.7.

GEMCO Mineral Resource and Ore Reserve Statements

This CPR includes information on Mineral Resources (inclusive of Ore Reserves) as reported by Mr D Hope (MAusIMM) and Ore Reserves as reported by Mr M Bryant (MAusIMM). The information is extracted from the BHP Billiton 2014 Annual Report (BHP Billiton, 2014) and is available to view on www.bhpbilliton.com.

At the time of reporting Mr Hope is a full-time employee of BHP Billiton and Mr Bryant is employed by Bryant Mining Pty Ltd. They have the required qualifications and experience to qualify as Competent Persons for Mineral Resources under the 2012 Edition of the "Australasian Code for Reporting of Exploration Results, Mineral Resources and Ore Reserves" (JORC Code). The Competent Persons verify that their report (Hope and Bryant, 2014) is based on and fairly reflects the Mineral Resources and Ore Reserves information in the supporting documentation and agree with the form and context of the information presented.

BHP Billiton confirms that it is not aware of any new information or data that materially affects the information included in the original market announcements and, in the case of estimates of Mineral Resources and Ore Reserves, that all material assumptions and technical parameters underpinning the estimates in the relevant market announcements continue to apply and have not materially changed. BHP Billiton confirms that the form and context in which the Competent Persons' findings are presented have not been materially modified from the original market announcements.

CSA Global has relied on two primary sources of data for the Mineral Resources and Ore Reserves of the Groote Eylandt Manganese Mine:

- Hope and Bryant (2014) and Hope (2014), collectively referred to in this CPR as 'CP FY14', and
- BHP Billiton (2013), referred to in this CPR as the FY15 LoA plan.

Author and Reviewer Signatures

Principal Author:	Bill Shaw	Signature:	<p>Electronic signature not for duplication. Electronic signature not for duplication. Electronic signature not for duplication. Electronic signature not for duplication. Electronic signature not for duplication. Electronic signature not for duplication. Electronic signature not for duplication. Electronic signature not for duplication. Electronic signature not for duplication. Electronic signature not for duplication.</p> 
Valuation:	Paddy Reidy	Signature:	<p>Electronic signature not for duplication. Electronic signature not for duplication. Electronic signature not for duplication. Electronic signature not for duplication. Electronic signature not for duplication. Electronic signature not for duplication. Electronic signature not for duplication. Electronic signature not for duplication. Electronic signature not for duplication. Electronic signature not for duplication.</p> 
Contributors:	As listed in Section 1.3		
Principal Reviewer:	Jeff Elliott	Signature:	<p>Electronic signature not for duplication. Electronic signature not for duplication. Electronic signature not for duplication. Electronic signature not for duplication. Electronic signature not for duplication. Electronic signature not for duplication. Electronic signature not for duplication. Electronic signature not for duplication. Electronic signature not for duplication. Electronic signature not for duplication.</p> 
CSA Global Authorisation:	Bill Shaw	Signature	<p>Electronic signature not for duplication. Electronic signature not for duplication. Electronic signature not for duplication. Electronic signature not for duplication. Electronic signature not for duplication. Electronic signature not for duplication. Electronic signature not for duplication. Electronic signature not for duplication. Electronic signature not for duplication. Electronic signature not for duplication.</p> 
		Date	5 March 2015

Revision:

Rev No.	Date	Revisions	Author	Approved

Contents

Executive Summary	I
Introduction	I
Social Licence to Mine	I
Mineral Resources and Ore Reserves	I
Risk Analysis	II
Valuation	III
ESMA Reporting Requirements	III
GEMCO Mineral Resource and Ore Reserve Statements	IV
Author and Reviewer Signatures	V
Contents	VI
1 Introduction	1
1.1 Terms of Reference	1
1.2 Reporting Standards	1
1.3 Report Authorship	2
1.4 Prior Association and Independence	3
1.5 Declarations and Limitations	3
1.6 Abbreviations and Units	4
2 Groote Eylandt Manganese Project	6
2.1 Project History and Background	6
2.2 Location and Access	7
2.3 Infrastructure, Power and Transport	7
2.4 Climate	8
2.5 Project Tenements	9
2.6 Environment, Health and Social Licence to Operate	11
2.6.1 Baseline Ecology	11
2.6.2 Water	11
2.6.3 Hydrocarbon Contamination	12
2.6.4 Health	12
2.6.5 Potential Environmental Impacts from Mining	13
2.6.6 Mine Closure Planning	14
2.6.7 Potential Social Impacts and Considerations	15
2.7 Social and Environmental Modifying Factors for the Ore Reserves	16
3 Mineral Resources and Ore Reserves	17
3.1 Geology	17
3.1.1 Stratigraphy	17
3.1.2 Manganese Mineralisation	19
3.1.3 Mine Geology	20
3.1.4 Exploration Opportunities	22
3.2 Mineral Resource Estimation	22
3.2.1 Sampling Techniques and Data	22
3.2.2 Geological Interpretation and Modelling	28
3.2.3 Statistical and Geostatistical Analysis	30
3.2.4 Estimation of Mineral Resources	31
3.2.5 Mineral Resource Classification and Statement	34
3.2.6 Sand Tailings	37
3.3 Mining	39
3.3.1 Major Facilities	39
3.3.2 Mining Method	39
3.3.3 Mine Production and Equipment	40
3.3.4 Mine Infrastructure	41
3.3.5 Rock Mechanics and Dumping	41

3.3.6	Processing	41
3.3.7	Tailings	42
3.3.8	Water	42
3.4	Ore Reserves	43
3.4.1	Mining Impacts on the Ore Reserves	43
3.4.2	Life of Asset	43
3.4.3	Yields in the Mineral Resources and Ore Reserves	45
3.4.4	Historic Production and Expenditures	46
3.4.5	Reconciliations	46
3.4.6	Modifying Factors	48
3.4.7	Mine Schedule and Validation	49
3.4.8	Risks and opportunities	51
4	Valuation of Ore Reserves	53
4.1	Valuation Methodology	53
4.2	Manganese Market and Outlook	53
4.3	Cash Flow Modelling and Assumptions	54
4.3.1	CSA Global Approach	54
4.3.2	Commodity Pricing Assumptions	55
4.3.3	Exchange Rate Assumptions	56
4.3.4	Discount Rate Determination	57
4.3.5	Ore Production Physicals	57
4.3.6	Operating Costs	58
4.3.7	Capital Costs	59
4.4	Undiscounted Cash Flows – Base Case	60
4.5	NPV Valuation – Base Case	60
4.6	NPV Valuation – Range Analysis	61
4.7	Sensitivity Analysis	62
4.8	Project Opportunities	64
4.9	Valuation Summary	65
5	References	66

Figures

Figure 1	Location of Groote Eylandt and the GEMCO mining leases	7
Figure 2	Groote Eylandt Airport mean temperature (°C) and mean rainfall (mm)	8
Figure 3	Geology of the western edge of Groote Eylandt	17
Figure 4	Stratigraphic column showing the manganiferous sequence	18
Figure 5	GEMCO lease boundaries and Quarry locations	21
Figure 6	Drill hole location plan	24
Figure 7	Scatterplot of Field Duplicate results for A assays	25
Figure 8	Scatterplot of Laboratory Repeat results for A assays	26
Figure 9	Cross section illustrating the ore horizons in the central part of the deposit	29
Figure 10	Mineral Resource classification boundaries	36
Figure 11	Illustration of the stages of strip mining on GEMCO's mining leases	40
Figure 12	Western side of Groote Eylandt showing GEMCO planned annual mining 'buckets' for the Life of Asset plan, as optimised using Blasor, and lease boundaries.	44
Figure 13	Life of Asset production profile by expected saleable product type	45
Figure 14	Reconciliation over a 14 month period of Actual Mined to the Ore Reserves for Total Tonnes and Yield	47
Figure 15	CSA Global forecast of Mn prices	56
Figure 16	Historic and forecast A\$/US\$ exchange rates	57
Figure 17	GEMCO ore production summary in the FY15 LoA plan after removal of Inferred Mineral Resource	58
Figure 18	GEMCO operating costs in US\$	59
Figure 19	GEMCO cash costs in US\$	59

Figure 20	GEMCO capital costs	60
Figure 21	GEMCO undiscounted cash flows – Base Case	60
Figure 22	Tornado diagram showing sensitivities of Base Case to key drivers (US\$ M)	62
Figure 23	Exchange rate and Mn price variance to Base Case	62
Figure 24	Product sales and Mn price variance to Base Case	63
Figure 25	Operating costs and Mn price variance to Base Case	63
Figure 26	Capital costs and Mn price variance to Base Case	63
Figure 27	Product grades and Mn price variance to Base Case	64
Figure 28	Discount rate and Mn price variance to Base Case	64

Tables

Table 1	Tenements related to GEMCO on Groote Eylandt	9
Table 2	GEMCO stratigraphic layer codes and descriptions	28
Table 3	Surface triangulations	29
Table 4	Search neighbourhood parameters	32
Table 5	Block model parameters	32
Table 6	Density assumptions	33
Table 7	GEMCO Mine Mineral Resource classification	35
Table 8	GEMCO Mine Mineral Resources at 30 June 2014	35
Table 9	GEMCO Mine Mineral Resources depleted to 31 December 2014	35
Table 10	GEMCO Sand Tailings Mineral Resource classification method	38
Table 11	GEMCO Sand Tailings Mineral Resources	38
Table 12	Historic performance of the Concentrator since FY06	41
Table 13	Historic production and costs for the last three years (C1 as US\$/t product)	46
Table 14	Reconciliation of mining volume with resource model volume	48
Table 15	Historic Yield adjustment factors	49
Table 16	GEMCO resource model constrained by specified model attributes	50
Table 17	G Quarry Resources downgraded to Inferred for Ore Reserve determination in FY14	50
Table 18	ROM Stocks for starting point adjustment	50
Table 19	Remaining Mineral Resources on mining leases with Modifying Factors applied	50
Table 20	GEMCO declared Ore Reserves at 30 June 2014 compared to CSA Global checks	51
Table 21	GEMCO Ore Reserves at 31 December 2014 after depletion of production since 30 June 2014	51
Table 22	Annual average manganese prices for the 44% SL Mn benchmark	54
Table 23	Key assumptions in deriving a Base Case value for the GEMCO Asset	55
Table 24	Base case value for GEMCO Asset over the Life Of Mine to end of FY27	61
Table 25	Range analysis of the GEMCO Asset value over the Life Of Mine to end of FY27	61

1 Introduction

1.1 Terms of Reference

BHP Billiton is a Dual Listed Company (DLC) comprising BHP Billiton Limited and BHP Billiton Plc. BHP Billiton was created through the DLC merger of BHP Limited (now BHP Billiton Limited) and Billiton Plc (now BHP Billiton Plc), which was concluded on 29 June 2001.

BHP Billiton Limited has a primary listing on the Australian Securities Exchange (ASX) and BHP Billiton Plc has a primary listing on the London Stock Exchange, with a secondary listing on the Johannesburg Stock Exchange. In addition BHP Billiton has two American Depositary Receipt listings on the New York Stock Exchange. BHP Billiton (which for the purposes of this CPR includes BHP Billiton Limited and BHP Billiton Plc) is considering the demerger of certain aluminium, coal, manganese, nickel and silver assets (Demerger).

The demerged assets will be held by South32 Limited (South32). It is currently intended that South32 will be listed on the ASX, the Johannesburg Stock Exchange (JSE), and on the Official List of the UKLA (together, the Relevant Listing Authorities).

If BHP Billiton pursues the Demerger, public market listing documentation must be prepared to list South32 in accordance with the rules of the Relevant Listing Authorities. BHP Billiton has commissioned CSA Global to compile a Competent Person Report on their manganese Mineral Resources and Ore Reserves. This CPR is for the GEMCO Asset of BHP Billiton and may be included in the documentation relating to the Relevant Listing Authorities' admission of South32's shares to listing, including an ASX Information Memorandum, a JSE pre-listing statement and a UK prospectus (the Listing Documentation).

This report complies with the rules and requirements of the Relevant Listing Authorities (including, in the case of a UKLA listing, the European Securities and Markets Authority's Recommendations on consistent implementation of Commission Regulation (EC) No 809/2004 implementing the Prospectus Directive (the ESMA Recommendations).

The GEMCO Asset is located in the Northern Territory (NT), Australia. The material data for the project area is discussed and tenement details are provided. CSA Global has been formally advised by GEMCO that the project tenements are held in good standing and has independently verified this through appropriate enquiries. A brief overview of the projects is outlined in the report. An Independent Valuation of the GEMCO Ore Reserves is also provided.

1.2 Reporting Standards

This report is consistent with the ESMA Recommendations as prescribed in the Commission Regulation (EC) No 809/2004 implementing the Prospectus Directive.

BHP Billiton and CSA Global have used the JORC Code (2012) for reporting Mineral Resources and Ore Reserves.

The Valuation has been prepared in accordance with the VALMIN Code (2005), which is binding upon Members of the Australasian Institute of Mining and Metallurgy (AusIMM) and the Australian Institute of Geoscientists (AIG).

The authors have taken due note of the rules and guidelines issued by such bodies as the Australian Securities and Investments Commission (ASIC) and the ASX, including ASIC Regulatory Guide 111 – Content of Expert Reports and ASIC Regulatory Guide 112 – Independence of Experts.

1.3 Report Authorship

This Report has been prepared by CSA Global, a privately-owned consulting company that has been operating from Perth, Western Australia for 30 years.

CSA Global provides multi-disciplinary services to clients in the global resources industry. CSA Global's services include project generation, exploration, resource estimation, project evaluation, development studies, mining operations assistance, and corporate consulting advice such as valuations and independent technical reports. CSA Global has worked for major clients globally and many junior resource companies. CSA Global personnel have been involved in the preparation of independent reports for listed companies in most international mining jurisdictions.

The principal authors of this report are Dr Bill Shaw, Global leader - Mining and Mr Padraig Reidy, Associate Consultant.

Dr Shaw is responsible for the geology, Mineral Resources and Ore Reserves and factors that impact on them.

Bill Shaw, PhD, MGeoSc (Mineral Economics), BSc (Geology), FAIG, RPGeo (registration number 10026), FAusIMM, CPGeo (registration number 104890), has over 40 years of experience in economic geology, resource evaluation and mining. He has audited Mineral Resources and Ore Reserves to international standards including the Australasian JORC, US Securities and Exchange Commission, Canadian NI 43-101 and South African SAMREC Codes. He has been involved in the management of large evaluation projects and major audits. He is a full-time employee of CSA Global, is currently on the Joint Ore Reserves Committee (JORC) and is President of the Australian Geoscience Council.

Dr Shaw has the relevant qualifications, experience, competence and independence to be considered an Expert under the definitions provided in the VALMIN Code and a Competent Person as defined in the JORC Code (2012).

Mr Reidy is responsible for the Valuation of the Ore Reserves.

Paddy Reidy, MSc (Mineral and Energy Economics), BA (Hons, Geology), MAusIMM, has over 17 years of experience in the international resource sector with corporate experience as CEO of an ASX listed junior exploration company, and consulting experience as Principal Consultant Geologist and Associate Consultant with CSA Global. He has extensive experience in project management, scoping and feasibility studies, project review, mineral asset valuation and Mineral Resource estimation. He has held senior positions with Rio Tinto Iron Ore as an Analyst, and with Gold Fields Ltd (St Ives) as a Business Analyst and Senior Geologist and is currently an Associate of CSA Global.

Mr Reidy has the relevant qualifications, experience, competence and independence to be considered an Expert under the definitions provided in the VALMIN Code and a Competent Person as defined in the JORC Code (2012).

Dr Shaw and Mr Reidy have been supported by other contributing authors in specific discipline areas, as follows:

- Mr Paul O’Callaghan – Principal Mining Engineer with CSA Global, reviewed the Ore Reserves and provided comments related to mining.
- Mr Aaron Meakin – Principal Resource Geologist with CSA Global, reviewed the Mineral Resources and provided comments on the methodology and results.
- Ms Kim Bennett – Principal Consultant with MWH Global reviewed issues related to environment and the social license to mine.
- The Valuation was reviewed by Ms Rebecca Barry, Principal Consultant with CSA Global.
- Peer review of this report has been undertaken by Mr Jeff Elliott who is the Managing Director of CSA Global.

1.4 Prior Association and Independence

Neither CSA Global, nor the authors of this report, has or has had previously, any material interest in BHP Billiton or the mineral properties in which BHP Billiton has an interest. CSA’s relationship with BHP Billiton is solely one of professional association between client and independent consultant.

CSA Global is an independent geological and mining consultancy. This report is prepared in return for professional fees based upon agreed commercial rates and the payment of these fees is not contingent on the results of this report.

No member or employee of CSA Global is, or is intended to be, a director, officer or other direct employee of BHP Billiton. Several CSA Global employees have minor shareholdings in BHP Billiton. Such shareholdings were declared and considered not material to the independence of this report. The lead author of this report, Dr Bill Shaw, holds a beneficial interest in 1200 BHP Billiton shares. There is no agreement between CSA Global and BHP Billiton regarding CSA Global conducting further work for BHP Billiton.

1.5 Declarations and Limitations

This Competent Person Report has been prepared by CSA Global at the request of, and for the sole benefit of BHP Billiton and South32 and can be relied upon by their shareholders. Its purpose is to provide an independent technical assessment and valuation of BHP Billiton’s GEMCO Asset in the Northern Territory of Australia. The Report is to be included in its entirety within the Listing Documents to be prepared by BHP Billiton and South32 (or their advisors) in connection with the Demerger of GEMCO from BHP Billiton. It is not intended to serve any purpose beyond that stated and should not be relied upon for any other purpose.

CSA Global has consented to the inclusion of the Report within the Listing Documents in the form and context in which it is to appear. Neither the whole nor any part of the Report may be included in or with, or attached to any other documents, circular, resolution, letter or statement without the prior written consent of CSA Global as to the form and context in which it is to appear.

This report has been compiled based on information available up to and including the date of this report. The statements and opinions are based on the reference date of 31 December 2014 and could alter over time depending on exploration results, mineral prices and other relevant market factors.

The information in this report that relates to the Mineral Resources and Ore Reserves has been compiled by Dr Bill Shaw, Global Leader – Mining and who is a full-time employee of CSA Global. Dr Shaw has sufficient experience relevant to the style of mineralisation and type of deposit under

consideration and to the activity which he is undertaking to qualify as a Competent Person as defined in the JORC Code (2012). Dr Shaw consents to the disclosure of this information in this report in the form and context in which it appears.

The information in this report that relates to Valuation of the Ore Reserves has been compiled by Mr Paddy Reidy, Principal Consultant - Valuations who is an Associate of CSA Global. Mr Reidy has sufficient experience relevant to the style of mineralisation and type of deposit under consideration and to the activity which he is undertaking to qualify as an Expert as defined in the VALMIN Code (2005). Mr Reidy consents to the disclosure of this information in this report in the form and context in which it appears.

1.6 Abbreviations and Units

A\$	Australian Dollar
A\$/US\$	Australian Dollar per US Dollar, exchange rate
AAS	atomic absorption spectrometry, an assaying method
AEP	annual exceedance probability design event (rainfall)
AIG	Australian Institute of Geoscientists
ALC	Anindilyakwa Land Council
ALRA	Aboriginal Land Rights (NT) Act 1976
ASIC	Australian Securities and Investments Commission
ASX	Australian Securities Exchange
AusIMM	Australasian Institute of Mining and Metallurgy
BOT	bottom mining horizon
BPF	Bypass Fines
BPL	Bypass Lump
CIF	cost insurance freight
CPR	Competent Person Report
CRM	certified reference material
CSA Global	CSA Global Pty Ltd
DCF	discounted cash flow
DGPS	differential global positioning system
DLC	dual listed company
DME	Department of Mines and Energy (NT Government)
EL	Exploration Licence
EME	earth moving equipment
ESMA	European Securities and Markets Authority
FY14	financial year ending 30 June 2014
GEAT	Groote Eylandt Aboriginal Trust
GEEP	Groote Eylandt Expansion Project
GEM PRO	GEMCO Procedures
GEM STA	GEMCO Standards
GEMCO	Groote Eylandt Mining Company Proprietary Limited
GL	Groote Lump
GF	Groote Fines
GLD	Group Level Documents of BHP Billiton
HDPE	high density polyethylene
HMS	heavy media separation
INT	interburden mining horizon
IPART	Independent Pricing and Regulatory Tribunal
JORC	Joint Ore Reserves Committee
JSE	Johannesburg Stock Exchange

LNAPL	light non-aqueous phase liquid (diesel fuel)
LoA	Life of Asset
LOI	Loss On Ignition, an assaying procedure
MA	Mining Agreement between GEMCO and the Anindilyakwa Land Council
MID	Middle mining horizon
MLN	Mining Lease (NT)
NATA	National Association of Testing Authorities
NPV	net present value
NT	Northern Territory of Australia
OBP	Optimised Base Plan
PC02	Premium Concentrate Project (the Sand Tailings recovery project)
PCS	Primary Crusher Stockpiles
PVR	Portfolio Valuation Review (an internal BHP Billiton process)
QAQC	quality assurance and quality control (for sampling and assaying)
QKNA	quantitative kriging neighbourhood analysis, studies to validate Mineral Resource estimation
RBA	Reserve Bank of Australia
RC	reverse circulation drilling
ROM	run of mine ore
South32	South32 Limited
SPL	Special Purpose Lease
SUBBOT	potentially economic mining horizon below the BOT mining horizon
TSF	tailings storage facility
UKLA	United Kingdom Listing Authority
US\$ M	millions of US Dollars
WACC	weighted average cost of capital
XRF	x-ray fluorescence, an assaying method

Units of measurement

dmtu	dry metric tonne units
ha	hectares
km	kilometres
km ²	square kilometres
ktpa	thousands of tonnes a year
l/sec	litres a second (flow rate)
m	metres
m ³ /day	cubic metres a day (flow rate)
mAHD	metres (above) average height datum
MI	million litres
mm	millimetres
Mt	million tonnes
Mtpa	million tonnes per annum
mtu	metric tonne unit
t	tonnes
t/m ³	tonnes per cubic metre (for <i>in situ</i> dry bulk density)
tph	tonnes per hour

2 Groote Eylandt Manganese Project

2.1 Project History and Background

Groote Eylandt Mining Company Proprietary Limited (GEMCO) is an open pit mining operation on Groote Eylandt in the Northern Territory (NT), Australia. The manganese ore is mined under agreements with the Government and the Traditional Owners, for which royalties are paid that make a significant economic contribution locally, regionally and nationally.

GEMCO pays royalties of 1.25% to the Groote Eylandt Aboriginal Trust (GEAT), 1.3% to the Anindilyakwa Land Council (ALC) and 20% to the NT Government. Collectively in FY14 these will provide more than A\$ 30 million to the local economy.

Groote Eylandt is the fourth largest island in Australia (after Tasmania, Melville Is. and Kangaroo Is.). It was named by Abel Tasman in 1644 meaning 'large island' in archaic Dutch. The Traditional Owners had a nomadic and maritime culture when the Church Missionary Society first arrived at Emerald River in 1921. Acquisition of the Mission airstrip during World War II resulted in that settlement moving in 1943 to what is now Angurugu Township, south of the Angurugu River and 5 km from the estuary mouth.

Outcropping high grade manganese was discovered in the early 1960s by Bill Smith of BHP Exploration. Extensive pitting and drilling was carried out and trial parcels of the manganese ore were shipped by barge. This led to the establishment by 1967 of a mining operation with an ore washing and sorting plant.

The Concentrator is now located central to the mining operations and is 16 km south along the Rowell Highway from the Port facilities at Milner Bay for shipping to predominantly Asian customers in close proximity.

GEMCO is a joint venture company owned 60% by BHP Billiton and 40% by Anglo American and operated by BHP Billiton. All manganese mining by GEMCO is done on Groote Eylandt and GEMCO owns, operates and is the sole shipper through the Milner Bay Port. The extent of BHP Billiton's manganese business in Australia consists of GEMCO and the similarly owned and operated joint venture for manganese smelter operations in Tasmania (TEMCO). TEMCO takes approximately 10% of GEMCO's sales but as it does not have Ore Reserves, it is not considered further in this report.

The high grade ore is mined and delivered by haul truck to the Concentrator where it is crushed, screened, washed and further beneficiated by heavy media separation. In FY14 the operation delivered 4.8 Mt of manganese product.

According to the 2015 Life of Asset plan (the FY15 LoA plan) on which the current Ore Reserves (CP FY14) are based, GEMCO has a current Ore Reserves life of 12.5 years.

The GEMCO Port capacity exceeds that of the Concentrator by 0.9 Mtpa creating an opportunity to increase shipped product by: reprocessing sand tailings, mining direct shipping ore and/or blending, which are options considered in the FY15 LoA plan.

GEMCO is the world's largest single producer of manganese ore, has the lowest landed cost into important Asian Markets and produces some of the world's highest grade manganese ores. The efficiency and cost minimisation focus over the last five years in BHP Billiton has resulted in the unit cost of production being reduced from US\$1.33/dmtu to US\$1.06/dmtu.

2.2 Location and Access

Groote Eylandt is a large Australian island on the western side of the Gulf of Carpentaria, approximately 50 km from the mainland, forming the eastern border of Arnhem Land. Access is by air from Darwin and Cairns with an all-weather strip used for to operate a fly-in, fly-out 7 day roster by a significant proportion of equipment operators and planning staff.

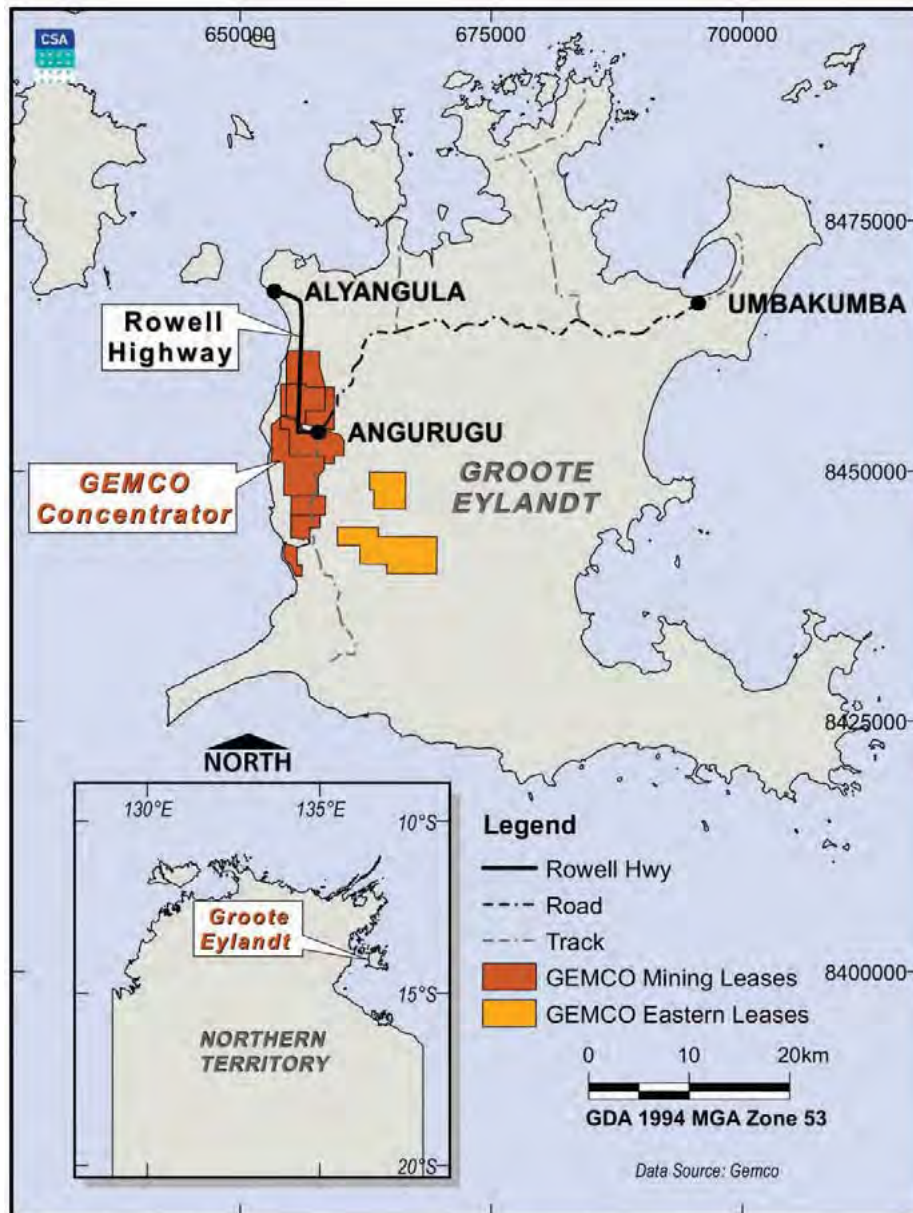

Figure 1 Location of Groote Eylandt and the GEMCO mining leases

2.3 Infrastructure, Power and Transport

Key infrastructure established by GEMCO on Groote Eylandt includes:

- Ore processing plant for beneficiation (the Concentrator)
- Stockpiles at the Concentrator, Port and related facilities
- Mine offices, workshops and associated facilities

- Rowell Highway and associated road transport facilities
- Airport and related facilities
- Milner Bay Port wharf facilities
- Communication, television and radio transmitter stations
- Rowell Highway power station
- Water treatment plant and pumping station on the Angurugu River
- Township of Alyangula, including housing, supermarket, arcade shops, police station, medical centre, school, various other accommodation and associated service utilities including sewerage and refuse treatment/disposal
- Bougainvillea Road from Dugong Beach Resort through the town of Alyangula and connecting with the Rowell Highway
- Golf course and sporting facilities west of Bougainvillea Road.

2.4 Climate

Groote Eylandt is located within the eastern section of the Arnhem Coast Region of the NT which experiences a tropical monsoonal climate characterised by distinct wet and dry seasons. The wet season is from December to March and is hot and humid with the majority of the annual rainfall falling during this period. The dry season is between April and November with warm, dry weather as a result of very dry east, southeasterly winds. The region also experiences cyclones during the wet season.

The nearest Bureau of Meteorology (BOM) weather station to the Project is located at the Groote Eylandt Airport (station number 014518). The temperature and rainfall records for the station date between 1999 and 2014. Monthly mean maximum temperatures for Groote Eylandt Airport range from 28.7 °C in July to 34.3 °C in November (Figure 2). The monthly mean minimum temperatures range from 15.0 °C in August to 25.1 °C in January. Mean monthly rainfall ranges from 333.1 mm in March to 0.9 mm in August, while the mean annual rainfall is 1,326.4 mm.

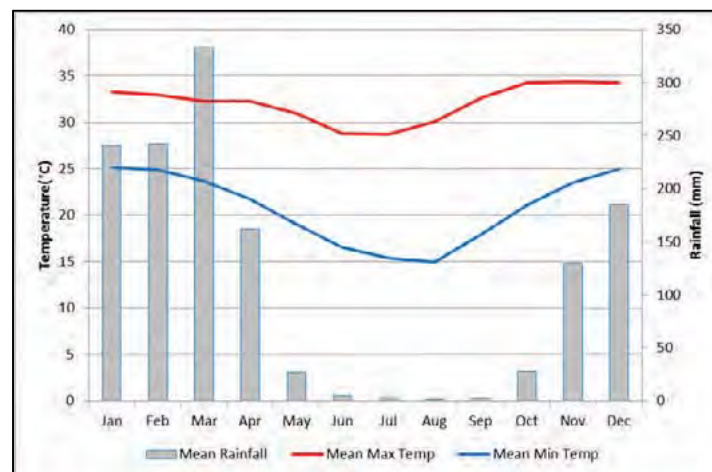

Figure 2 Groote Eylandt Airport mean temperature (°C) and mean rainfall (mm)
Source: Bureau of Meteorology website

The Average Recurrence Interval for rainfall at the Groote Eylandt Airport indicates that the expected rainfall intensity over a 72 hour period, 100 year event is 8.57 mm per hour, a total of 617 mm in three days. Cyclones may rarely have a significant short-term impact on production.

2.5 Project Tenements

A summary of GEMCO's tenements for exploration, mining and special purposes (ancillary to mining) on Groote Eylandt is provided in Table 1.

Groote Eylandt is Aboriginal owned land granted under the Aboriginal Land Rights (NT) Act 1976 (ALRA). GEMCO's obligations are chiefly embodied in various lease documents including Mineral Leases and Special Purpose Leases, a Letter of Understanding dated 13 May 1965 between GEMCO and the Commonwealth of Australia and a Mining Agreement dated 4 October 2006 between GEMCO and the Anindilyakwa Land Council. These documents cover mining operations, the township, welfare of the Traditional Owners, two Exploration Leases east of the current operations (the 'Eastern Leases') and other aspects ancillary to the Company's operations.

Table 1 Tenements related to GEMCO on Groote Eylandt

Tenement	Area	Holder	Status	Expiry	Notes
EL2455	1139.41 km ²	Groote Eylandt Mining Company Proprietary Limited	Application	Statutory two year negotiation period expires 31 October 2015	Southern half of Groote Eylandt
EL2457	1023.21 km ²	Groote Eylandt Mining Company Proprietary Limited	Application	Statutory two year negotiation period expires 31 October 2015	Northern half of Groote Eylandt
ELR28161	1249 ha	Groote Eylandt Mining Company Proprietary Limited	Granted Exploration Licence in Retention	16/11/2015	Groote Eylandt Eastern Leases (north)
ELR28162	3165 ha	Groote Eylandt Mining Company Proprietary Limited	Granted Exploration Licence in Retention	24/11/2015	Groote Eylandt Eastern Leases (south)
MLN2	1.38 ha	Groote Eylandt Mining Company Proprietary Limited	Granted Mineral Lease – Infrastructure Lease	29/09/2031	Power line, Rowell Highway and Bartalumba Bay Intersection
MLN3	1.65 ha	Groote Eylandt Mining Company Proprietary Limited	Granted Mineral Lease – Infrastructure Lease	24/07/2027	Haul Road Angurugu Creek Bridge
MLN951	1154.55 ha	Groote Eylandt Mining Company Proprietary Limited	Granted Mineral Lease	20/07/2031	C Quarry and F1 lease including explosives and magazine storage areas
MLN952	665.7 ha	Groote Eylandt Mining Company Proprietary Limited	Granted Mineral Lease	20/07/2031	D Quarry
MLN953	1464.31 ha	Groote Eylandt Mining Company Proprietary Limited	Granted Mineral Lease	20/07/2031	Dam areas, E South, A South, G Quarry and minesite
MLN956	1179.68 ha	Groote Eylandt Mining Company Proprietary Limited	Granted Mineral Lease	29/09/2031	F3 and F3 North including Ndunga and Rowell Highway
MLN957	175.23 ha	Groote Eylandt Mining Company Proprietary Limited	Granted Mineral Lease	29/09/2031	West Rowell Highway – North Angurugu Creek



Tenement	Area	Holder	Status	Expiry	Notes
MLN958	685.93 ha	Groote Eylandt Mining Company Proprietary Limited	Granted Mineral Lease	29/09/2031	F1 and F4 Quarry and Airstrip
MLN959	2113.63 ha	Groote Eylandt Mining Company Proprietary Limited	Granted Mineral Lease	29/09/2031	B Quarry and part D Quarry Road
MLN960	566.55 ha	Groote Eylandt Mining Company Proprietary Limited	Granted Mineral Lease	29/09/2031	D Quarry to Emerald River
MLN961	334.68 ha	Groote Eylandt Mining Company Proprietary Limited	Granted Mineral Lease	29/09/2031	Emerald River South
SPL 382 (Por. 1302, 1307) (Vol. 141, Fol. 4)	7.52 ha	Groote Eylandt Mining Company Proprietary Limited	Granted	29/05/2065	Associated lease S18(4a) (ALRA) Agreement over portion 1632 expiring 13/05/2022 for the purpose of storm water storage management and related activities to be conducted on SPL382
SPL 383 (Por. 1301, 1306) (Vol. 141, Fol. 7)	51.19 ha	Groote Eylandt Mining Company Proprietary Limited	Granted	29/05/2065	Associated lease (LandAssist Ref GEMCO0008) Sublease – Australian Telecommunications Commission Cth)
SPL 392 (Por. 1478) (Vol. 141, Fol. 5)	109.60 ha	Groote Eylandt Mining Company Proprietary Limited	Granted	29/05/2065	Associated leases: (LandAssist Ref GEMCO0011) Sublease – Australian Telecommunications Commission Cth). (LandAssist Ref GEMCO0012) Sublease – Groote Eylandt & Bickerton Island Enterprise Aboriginal Corporation. (LandAssist Ref GEMCO0013) Sublease – Telstra Corporation Limited. (LandAssist Ref GEMCO0015) Sublease – Amangarra Aboriginal Corporation. (LandAssist Ref GEMCO0016) Sublease – TJ McCausland.
SPL 393 (Por. 1479) (Vol. 141, Fol. 6)	89.87 ha	Groote Eylandt Mining Company Proprietary Limited	Granted	29/05/2065	Associated lease (LandAssist Ref GEMCO0009) Sublease – Telstra Corporation Limited / Australian Telecommunications Commission (Cth).

The key project risk related to tenure is the expiry date of MLNs 2, 3, 951, 953, 956, 957, 958, 959, 960 and 961 as they all expire in either 2027 or 2031. The FY15 LoA plan has embedded options that consider a mine life extension beyond FY28, hence GEMCO decommissioning and closure activities would be ongoing past the current expiry date of these tenements. BHP Billiton has flagged tenure issues as a risk however CSA Global believes that there are mitigation strategies in place that make the likelihood of losing the tenements low.

CSA Global has reviewed the tenure status on the Northern Territory Department of Mines and Energy Spatial Territory Resource Information Kit for Exploration (STRIKE) website at the 1st

December 2014. All of the Mining Leases and Exploration Leases are listed as Current. The four Special Purpose Leases (SPLs) are listed in the NT Spatial Data Directory of the Department of Lands Planning and the Environment and are also current.

2.6 Environment, Health and Social Licence to Operate

2.6.1 Baseline Ecology

Groote Eylandt is classed as tropical savannah. This climate region can be defined by a flat, grass-covered area in tropical or subtropical areas, nearly treeless in some places but generally having a mix of widely spaced trees and bushes. Savannahs have distinct wet and dry seasons, with the mix of vegetation dependent primarily on the relative length of the two seasons.

CSA Global has examined available documentation and considers that appropriate ecological, flora and fauna studies have been carried out on the GEMCO tenements for consideration in the environmental management planning process.

2.6.2 Water

GEMCO commenced the collection of water accounting data in 2011. A water management strategy has been integrated into the GEMCO LoA plan and will become part of future five year and two year plans. This will ensure catchment management and infrastructure availability for effective water usage and release is planned in compliance with regulatory and community expectations.

The mine site uses water for the Concentrator, general human consumption, washing down of vehicles/equipment and for dust suppression. The greatest consumer of water at the mine site is the Concentrator, however a significant component of this is re-used water; i.e. water that has been discharged from the plant through tailings then recovered from the Tailing Storage Facilities (TSFs) and returned to the Concentrator for re-use. Additional water for the Concentrator is obtained from a number of sources including bore fields, dewatered pit water and from the Angurugu River.

During the wet season, prolonged periods of significant rainfall may lead to a risk of water storage levels increasing and a subsequent breach of containment. GEMCO's management of water during the wet season is in line with risk management principles, with the first preference to avoid the need to discharge water by transferring water between storage facilities.

Water supply options for the life of the GEMCO operation are:

- re-use of water
- use of dewatered pit water
- abstraction from bore fields (currently D Quarry and E South bore fields)
- abstraction from the Angurugu River.

The main supply risk for the operation is the inability to abstract water from the Angurugu River which may be prompted by: a legislative requirement; limited recharge of the aquifer that feeds Angurugu River due to low rainfall; or stakeholder demands. If this were to occur, the shortfall would be made up of de-watered pit water or bore water. The risk of not being able to do this is considered low because currently the operation is dewatering volumes significantly larger than the forecast annual consumption.

GEMCO considered that the previous static water balance model was inadequate for predicting water management requirements for the mine over time. Site personnel had been unable to produce reliable life of asset water accounts for likely scenarios such as 1:100 year rainfall, drought, and extreme single rainfall events. GEMCO engaged consultants to develop a site-wide Water Balance Forecasting Model. The key outcomes were:

- Determination of the pumping capacities to mitigate 1 in 100 Annual Exceedance Probability (AEP) rainfall design events to reduce the risk of overflow from the TSFs
- Determination of the pumping capacities within the Quarries for 1 in 20 AEP design events to maintain operations and access to manganese ore
- Definition of the water storage requirements to maintain water supply to the Concentrator for a 1 in 20 AEP dry year.

2.6.3 Hydrocarbon Contamination

During construction excavation works in early 1995 a leaking fuel line was uncovered within the Milner Bay Port facility. To prevent the migration of light non-aqueous phase liquid (LNAPL) (diesel fuel) into the marine environment, a high density polyethylene (HDPE) barrier was installed across the Milner Bay foreshore to a depth of 4 metres. As part of the remediation activities, 86 pneumatically driven skimmer pumps were used over a 6 ha area to recover LNAPL. It is understood that the total LNAPL recovered between 1996 and 2003 was approximately 1.5 ML. In 2003, the LNAPL annual recovery had slowed to 17,000 l.

The LNAPL plume is described as being contained between a basin structure of Groote Eylandt beds, consisting of quartzite which prevents migration to the north, east and south of the Port facility and a HDPE barrier installed along the Milner Bay foreshore. As groundwater in this area typically ranges from 0 mAHD to 1.5 mAHD, the barrier prevents LNAPL migration into the marine environment to the west. The extent of the dissolved phase petroleum hydrocarbon contamination inland of the HDPE barrier has not been fully delineated. In April 2013 a step-wise approach was proposed to manage site remediation that included short-term (1 to 3 years), medium term (2 to 5 years) and long term (more than 3 years) measures, with a five year post-remediation monitoring programme.

A remediation plan for Milner Bay has been finalised; execution has commenced, and will be implemented from FY14 to FY18. The costs are included in the closure planning and risk assessments carried out by GEMCO.

2.6.4 Health

Air emissions are managed through the application of the GEM STA 3080 Air Emissions Management Plan. This provides a framework for the environmental management of the mining and road operations on Groote Eylandt to minimise the generation of dust. To monitor effectiveness, low volume air samplers are installed in the townships of Alyangula, Angurugu and a background station. The air samplers are monitored daily.

In line with statutory legislation GEMCO monitors mine workers' health including exposure to dust (silica and manganese) and toxic chemicals used for general industrial purposes.

The mineralogy and oxidised nature of the Groote Eylandt Manganese ores are such that fibrous minerals (such as asbestos) are not considered to be a health risk for mine workers. Some older

buildings in the Township have been found to contain asbestos building materials and appropriate safeguards are used during maintenance and/or demolition.

Several exotic mosquito species are vectors for diseases such as dengue, Ross River virus, and chikungunya. To reduce the infection risk in the Alyangula community, GEMCO conducts regular mosquito monitoring and control measures in collaboration with the Medical Entomology (ME) group of the Department of Health and Families.

2.6.5 Potential Environmental Impacts from Mining

Mining operations in the Northern Territory are authorised by the NT Government by approval of the Mine Management Plan, as outlined in Division 2 of the Mining Management Act. The GEMCO Mining Management Plan is the core document that guides the mining activity, environmental management, community aspects, risk management and ultimate closure of the mine.

Key mining impacts to land, marine and freshwater resources on the GEMCO leases are:

- landform alteration – due to blasting and mineral extraction and to a lesser extent tailings storage facilities
- vegetation clearance – during infrastructure construction, exploration drilling and overburden stripping
- dewatering of Quarries and indirect dewatering of adjacent areas
- direct and indirect discharges to water bodies
- waste and hazardous materials management.

Indirect mining impacts include:

- altered fire regimes
- feral animals
- environmental weeds.

To manage potential environmental impacts from mining, BHP Billiton has a standardised framework of Group Level Documents (GLD) and GEMCO Standards or Procedures (GEM STA or PRO) which comprise policies, standards, manuals and procedures, of which the following relevant ones were reviewed:

- GLD 009 Environment
- GLD 017 Risk Management
- GEM STA 3056 Threatened Species Management Plan
- GEM STA 3085 Land and Biodiversity Management Plan
- GEM STA 3316 Waste Management Standard
- GEM STA 22700 Rehabilitation Standard
- GEM STA 22285 FY14 Closure Plan
- GEM PRO 3181 Rehabilitation Monitoring and Evaluation Procedure
- GEM PRO 4241 Land Disturbance Tracking Procedure
- GEM PRO 21742 Rehabilitation Planning Procedure.

2.6.6 Mine Closure Planning

To address environmental impacts post-mining, GEMCO has developed the FY14 Closure Plan to meet BHP Billiton's GLD requirements. The Closure Plan outlines the key requirements for closure as:

- A closure schedule, based on the current LoA
- Post closure land and infrastructure use objectives
- Completion criteria
- Post closure land and infrastructure alternatives
- Deconstruction, demolition and demobilisation
- Design and engineering for remaining structures
- Rehabilitation and remediation of contaminated sites
- Treatment and disposal of wastes
- Human resources
- Community and external affairs
- Monitoring of rehabilitation performance, maintenance and reporting
- Risk analysis and control
- Cost estimation
- Action plans and accountabilities.

GEMCO is committed to the following high level post-closure criteria, underpinned by agreements with representatives of the Traditional Owners and a 2008 Department of Mines and Energy (DME) advisory note on mine close out objectives:

1. to leave the site in a safe condition;
2. to create stable, non-polluting and functioning landforms that are, as far as practically achievable, consistent with the surrounding landscapes and other environmental values; and
3. rehabilitation should seek to minimise environmental impacts resulting from permanent changes to the ecosystem.

The key contractual commitments to the community for mine closure are discussed in the Mining Agreement (MA) that exists between GEMCO and the Anindilyakwa Land Council which was established at mine commencement. In accordance with the MA, GEMCO will "leave the surface in a safe condition and in a reasonable contour having regard to the state of the surface area prior to the activity". Under the agreement there is a requirement for GEMCO to progressively rehabilitate disturbed land. The expectations and requirements for mine site rehabilitation during both operation and post-closure are detailed in the Rehabilitation Standard.

Milner Bay Remediation is specifically identified as a standalone item for Closure Planning. This is documented in the Milner Bay Remediation Plan as noted above (Section 2.6.3).

It is assumed that at least seven other contaminated sites will require some form of remediation prior to GEMCO leaving the site. The Land and Biodiversity Management Plan, addresses these sites. GEMCO acknowledges that it currently does not have sufficient information on the contaminated sites to accurately estimate the costs involved with remediation. However, the probabilistic approach used for forecasting closure costs combined with a closure contingency

provision of 40% is considered adequate to account for additional site remediation that may be required.

The FY14 Closure Plan is consistent with the LoA FY15 document that indicates mining operations will cease in 2027. While rehabilitation of mined-out parts of the mine site occurs on an ongoing basis, closure works for the remainder of the mine site commence in FY28 and will likely last three to five years. Ongoing post-closure monitoring is nominally planned for the period FY31 to FY51.

Since the publication of the FY14 Closure Plan, GEMCO has developed the FY16 LoA plan. The estimated cost of closure has been updated from US\$311 million (as determined in the FY14 Closure Plan) to US\$390 million. This increase is to recognise the extension of mine life in the LoA FY16 document; that is the mine is now expected to cease in 2030 as opposed to 2027. The additional cost of closure relates to rehabilitation of additional tailings produced from the extended mine life. This updated cost was used by CSA Global in preparation of the Valuation for this CPR.

2.6.7 Potential Social Impacts and Considerations

In 1964, special mining leases over portions of Groote Eylandt were granted to GEMCO by the Commonwealth Government and Traditional Owners.

GEMCO is the holder of special purpose leases for operating facilities ancillary to the actual mining operation, including Special Purpose Lease SPL382 for the Port and wharf area, SPL383 for stockpiling ore, SPL392 for the Alyangula Township and SPL393 for the green belt area surrounding the Alyangula Township.

Beyond the mine leases and government infrastructure facilities (such as the Airport and the Sea Rangers), land use on Groote Eylandt comprises the Township of Angurugu (adjacent to the mine leases), the Township of Umbakumba (on the eastern side of the island), semi-permanent collections of residences at various locations ('outstations') and traditional indigenous land uses.

The following Group Level Documents (GLD), GEMCO Standards (GEM STA) and GEMCO Procedures (GEM PRO), prepared by BHP Billiton to manage potential social impacts, were examined:

- GLD 008 Community
- GLD 017 Risk Management
- GEM STA 3070 Community Development Management Plan
- GEM STA 3174 Stakeholder Analysis and Engagement Plan
- GEM STA 22285 FY14 Closure Plan.

Processes for engaging and responding to community stakeholders are contained in the GEMCO Stakeholder Analysis and Engagement Plan. Identified stakeholder groups that may interact with the mine during its life and at mine closure include:

- GEMCO employees and contracting partners
- Anindilyakwa Land Council via the ALC Mining Liaison Committee
- Traditional Owners
- Local providers of NT Government Services (e.g. health, education, police)
- Local businesses
- Various Federal and NT government Ministers, and parliamentary members
- Government Departments and Agencies.

Access to the mining leases is vital for mining and a 'partner of choice' strategy has been adopted by GEMCO to ensure trust and integrity is maintained between Traditional Owners and GEMCO.

2.7 Social and Environmental Modifying Factors for the Ore Reserves

CSA Global considers that GEMCO has adequate systems and procedures in place that allow for the satisfactory identification of legal, tenure, environmental, social and infrastructure related issues, their relative risk and financial liability, and their influence on the ultimate value of the project. Material considerations arising from the review and qualitative assessments are:

Mine Closure Cost and Liability

The mine is planned to remain operating until at least 2030. Adequate mine closure plans and estimation of the cost of closure have been prepared in accordance with BHP Billiton's Mine Closure Standard and subject to internal reporting and review. Key items post-mining that have the highest degree of financial uncertainty are:

- successfully meeting the post-closure mine rehabilitation criteria (Section 2.6.6)
- successful remediation of hydrocarbon-contaminated areas at Milner Bay (Section 2.6.3)
- next uses for infrastructure items, once GEMCO operations have ceased (e.g. the Alyangula Township and the Airport).

The financial uncertainty of these (and other) potential impacts are adequately covered through the systematic application of probabilistic estimation techniques to forecast closure costs, as well as the inclusion of a 40% contingency to the current estimation.

Social Responsibility

Maintaining effective relationships with the Traditional Owners, the Anindilyakwa Land Council and other key local indigenous groups is of paramount importance to GEMCO. In 2008 an exploration licence application was vetoed, and locally the mining operations can be interrupted by Traditional Owners. The FY15 LoA plan indicates that community relation plans and interruption plans are in place and that extensive disruption of mining is considered to be unlikely by both GEMCO and CSA Global.

Expiry of Tenure

As outlined in Section 2.5 (Table 1) a number of leases are due to expire between October 2015 and 2031. GEMCO will have a requirement to maintain existing tenure beyond this date to allow for mine rehabilitation and post-closure monitoring to continue. The FY14 Closure Plan outlines post-closure activities continuing to 2050. The FY16 LoA plan also references potential 'unapproved capital projects' and 'other recommended opportunities' which may extend the mine life beyond the current lease expiry in 2031.

Mine Rehabilitation

Specific key environmental aspects of mine rehabilitation are:

- successful re-establishment of acceptable savannah ecosystems
- successful re-establishment of landforms that have acceptable water management
- successful remediation of contaminated lands
- successful establishment of acceptable pit void landforms
- successful establishment of acceptable tailings storage landforms
- successful relinquishment of the land to the representatives of the Traditional Owners.

3 Mineral Resources and Ore Reserves

3.1 Geology

3.1.1 Stratigraphy

Groote Eylandt is predominantly composed of a stable basement of Proterozoic sandstones and quartzites that outcrop over much of this large island. The manganese deposits are part of a blanket of Cretaceous sediments which overlie the sandstone along the western margin (Figure 3). Manganese mineralisation occurs as sedimentary layers between clay and sand beds beneath the western plains of Groote Eylandt. The mineralisation extends over a known area of approximately 50 km and is almost continuous, ranging in thickness up to 11 m.

Erosional channels in the basement are thought to have influenced both the original sedimentary deposition and supergene enrichment.



Figure 3 Geology of the western edge of Groote Eylandt
Proterozoic sandstone (brown), Cretaceous sediments (yellow)

The Cretaceous stratigraphy of Groote Eylandt is well understood following 50 years of mining. It comprises four main sequences (with approximate ages):

- Quaternary Soil (less than 3 Million years)
- Tertiary Laterite and Clay (3 to 65 Million years)
- Lower Cretaceous Sediments, the manganese mineralisation host (136 Million years)
- Mid-Proterozoic Basement (1,800 Million years).

The stratigraphic column is shown in Figure 4 which identifies the Middle Mining Horizon (MID) and Lower Mining Horizon (BOT), further discussed in Section 3.2.2.

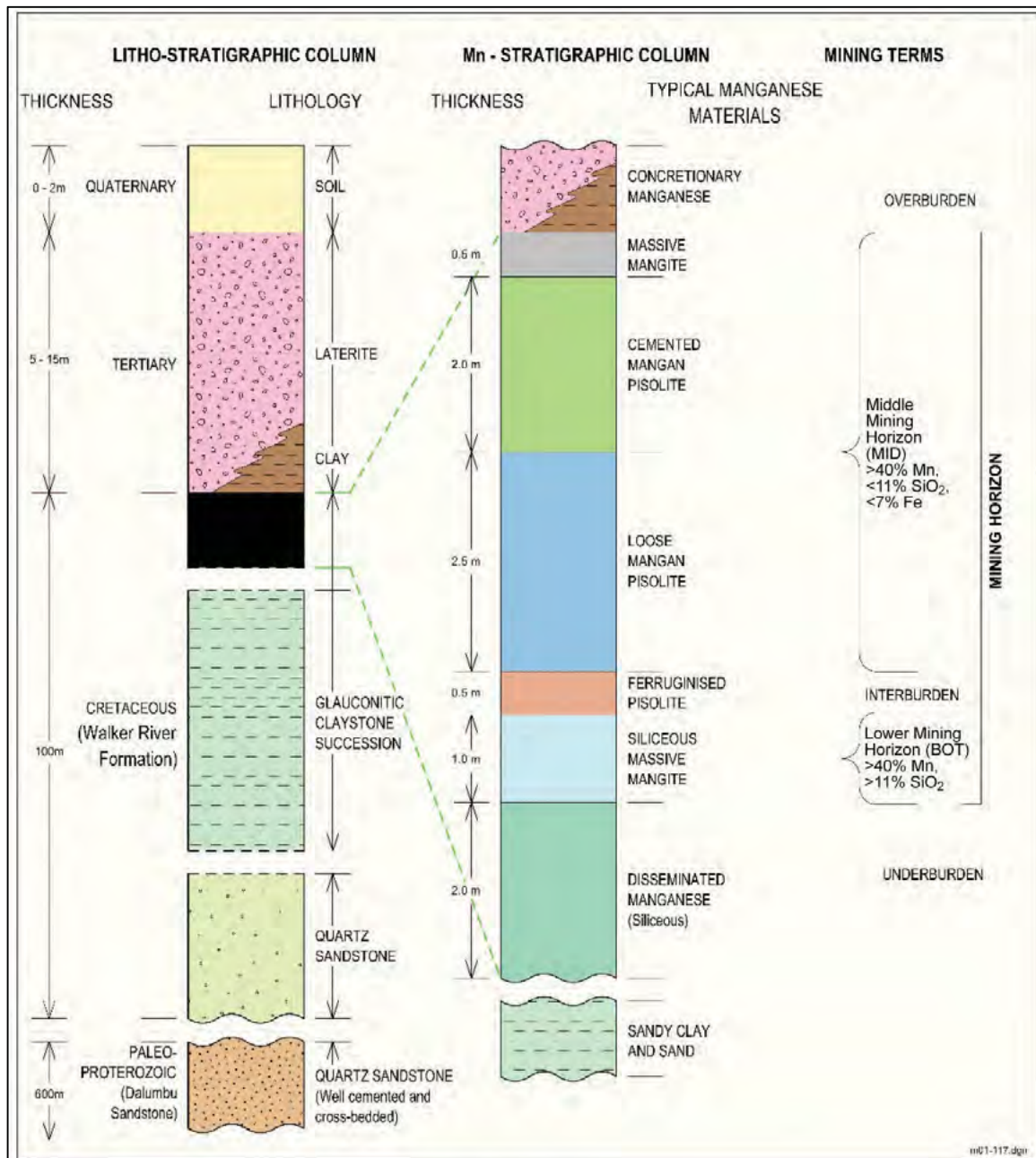

Figure 4 Stratigraphic column showing the manganese sequence

Source: Modified from Ferenczi (2001)

3.1.2 Manganese Mineralisation

Two main phases of mineralisation are evident as described below.

Phase 1 – Primary Manganese Sedimentary Deposition

Mining faces, trenches and drill core show that the manganese was deposited as a chemical precipitate in a shallow marine, high-energy environment during a period of sea level transgression and regression. This led to the formation of a laterally extensive, tabular, stratabound deposit. The primary manganese-bearing strata comprise pisolite and oolite. Pisolite is composed of pisoliths, which are greater than 2 mm in diameter; oolite is composed of oololiths which are smaller. These roundish particles were built up by chemical and/or physical accretion during wave action in relatively shallow water. Evidence to support a shallow marine environment of deposition includes normal- and reverse-graded bedding, cross-bedding and ripple marks.

Two main sedimentary facies host the manganese mineralisation. These facies have been termed the pisolite facies and siliceous facies. The broad characteristics of each are listed below consistent with published work (Frakes and Bolton, 1984; Ostwald, 1988; Pracejus and Bolton, 1992; Ferenczi, 2001).

Pisolite facies:

- Represents the dominant ore type, predominantly pyrolusite (MnO_2)
- Generally confined to palaeo-seafloor terraces close to palaeo highs
- Thickest on terraces
- Forms massive, cemented or loose pisolitic / oolitic rock types
- Stratigraphically above the siliceous facies.

Siliceous facies:

- Represents the most widespread style of primary mineralisation
- Occurs as thin bands and disseminations dispersed in clays and sands
- Consists of massive cryptomelane and pyrolusite with abundant quartz sand inclusions
- Subject to deposition of manganese from downward transport during lateritisation
- Stratigraphically below the pisolite facies.

Phase 2 – Secondary Manganese Supergene Enrichment

Following exposure, tropical weathering and lateritisation modified these soft sedimentary manganese units. Manganese, iron, silica and alumina were mobilised in the vertical profile. Pisolitic and oolitic manganese underwent partial to complete remobilisation and recrystallization which resulted in the development of cryptomelane cementation resulting in hard cemented pisolite, cemented oolite and massive mangite lithologies. This process of enrichment was accompanied in some cases by movement of kaolinite and illite clays, and silica sand, in the laterite profile. The Phase 2 supergene enrichment is subdivided into three main types of mineralisation as follows:

- massive mangite – comprised of massive manganese oxides usually occurring as a thin layer capping the mineralisation sequence. This type of mineralisation has formed from secondary enrichment and recrystallization of primary pisolitic mineralisation.
- cemented mangan pisolite/oolite – the pisoliths/oololiths are cemented by a matrix of secondary manganese oxides; usually occurring in the upper part of the mineralised sequence.

- loose mangan pisolite/oolite – the pisoliths/ooliths are weakly bound by a matrix of clays and sand.

3.1.3 Mine Geology

The mineralisation is mined as two horizons, the Middle (MID) and Bottom (BOT) ore horizons. The MID ore horizon is a massive high-grade layer comprising cemented and loose pisolitic lithologies. The BOT ore horizon is predominantly silica-rich massive manganese (massive siliceous mangite).

In some cases a non-manganiferous split can be identified between the MID and BOT, referred to as the Interburden (INT) horizon. This is potentially selectively mined and discarded as waste where the thickness exceeds 1 m and the lateral continuity is identified in the 60 m spaced drilling.

Below the BOT ore horizon there are further thin manganese bearing layers (down to 10 cm thickness) within porcellanite clays; this is referred to as the SUBBOT horizon. While not currently mined, and so not included in the Ore Reserves, there is potential to stockpile this material and use it as low grade feed. The current mining strategy of progressive strip mining means that where the SUBBOT is not currently economically recoverable, it is covered over again with backfill after extraction of the BOT horizon.

Figure 5 shows the location of the mining areas (Quarries) in relation to the leases.

There is considerable variation locally in the ore types mined on the various MLNs. To the north the F Quarries have historically been a source of premium grade Lump and Fines (48 to 51 % Mn as product) material due to the preponderance of cemented pisolite. In the centre of the deposit (closer to the Concentrator) the ores are soft, sticky, loose manganese oolite to the east (G Quarry) becoming loose pisolite in A Quarry and siliceous mangite to the west (E Quarry). To the south, D Quarry has consistently been a source of Metallurgical Lump grade ore with higher Fe and SiO₂ grades than F Quarry and consequently slightly lower Mn grades (45 to 48 % Mn as product).

The subtle grade variation in manganese across the deposit is complicated by the sandy clays associated with the ore. As this diluting material varies so does the recovery (Yield) of Lump and Fines products in the Concentrator, however the grades of product are uniform and predictable.

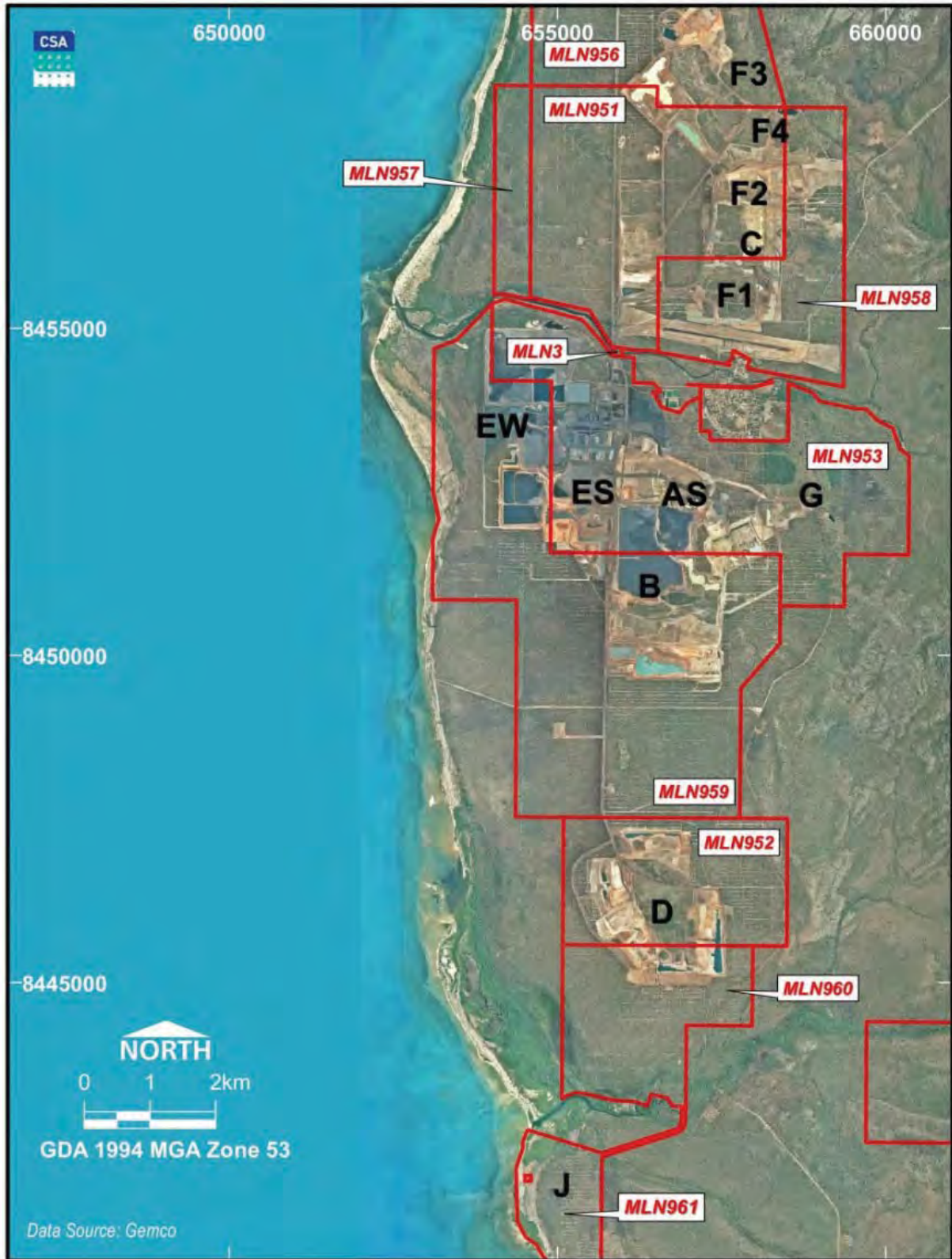

Figure 5 GEMCO lease boundaries and Quarry locations

3.1.4 Exploration Opportunities

GEMCO's key constraint is its resource size and mine life which is being addressed through substantial land access and exploration programs on Groote Eylandt and in East Arnhem Land.

In addition to the Mining Leases on Groote Eylandt, Table 1 lists a number of Exploration Licences (ELs) on Groote Eylandt, including the 'Eastern Leases' and the 'Southern Area'.

The Eastern Leases (ELR28161 and 28162) are located 25 km southeast of the township of Alyangula. GEMCO has commenced evaluation of these and has included their potential impact in internal 'range analysis' discussions. These are included in the FY14 Mineral Resource evaluated by CSA Global but are not yet part of the Ore Reserves. Negotiations to convert the Eastern Leases to mining leases have commenced. Once this is confirmed, some of the Mineral Resources may be converted to Ore Reserves and this will add approximately two and a half years to the mine life. The mine planning approach (Section 0) means that once the ore there is identified it can be fed into the mining schedule at the appropriate time. With other potential ore sources such as the Sand Tailings (see Section 3.2.6), the Eastern Leases can be considered as extending the mine beyond the FY15 LoA plan (from FY27 to FY32).

The Southern Area is located in the southwest corner of Groote Eylandt, 20 km from the Concentrator. This area was last explored during the 1960s. GEMCO has recently completed reconnaissance studies and is negotiating access prior to the granting of an Exploration Licence.

GEMCO has considerable other exploration interests on adjacent islands (Bickerton and Woodah Islands) and on the mainland of the NT adjacent to Groote Eylandt. None of these have a declared Mineral Resource and they are not considered material to this CPR evaluation of GEMCO. While in time they may create opportunities to extend the life of the GEMCO Asset, discovery of a significant new Mineral Resource would not necessarily see the ore processed in the Concentrator on Groote Eylandt nor product shipped from the Milner Bay Port. Also relevant is that Traditional Ownership also impacts most new mine development in the NT.

3.2 Mineral Resource Estimation

3.2.1 Sampling Techniques and Data

Data used to prepare the GEMCO Mineral Resource estimate (Hope and Bryant, 2014) is sourced only from drill holes using acceptable sampling techniques. Although pitting, trenching and costeans were used for early exploration, drill hole data has been collected during numerous campaigns carried out from 1967 through 2012. The quality of drilling data has varied over this period. Open hole rotary percussion and tricone drilling methods were initially used, but since 1979, reverse circulation (RC) drilling has been used. The RC drilling accounts for the majority of the data. Diamond drilling has recently commenced to verify the A Assay grades and Yields. Data from this core drilling has only been used in the Mineral Resource estimation process for geological modelling and to update *in situ* bulk densities, due to differences in the sample support and assaying methods compared to the majority of available data (RC drilling with A assays).

The integrity of the early drill hole data is subject to some uncertainty due to the sampling methods acceptable at that time. For this reason, many drill holes were removed from the database prior to geological modelling and Mineral Resource estimation. The total dataset comprised 15,573 drill holes prior to preparation of the Mineral Resource estimate. Following an assessment of data integrity, 10,955 drill holes were retained for geological modelling and 10,848 drill holes were retained for grade estimation. Drill holes used in the Mineral Resource estimate are shown in Figure

6. This shows that the part of the Mineral Resource not yet mined is substantially informed by RC drilling (post 1979 drilling).

Drill hole collars have generally been survey located using a differential global positioning system (DGPS) after completion of drilling. The drill holes are all vertical and shallow, hence downhole surveying is not carried out. The mean drill hole depth is 21 m.

Geological logging of drill holes has been routinely completed. Data has been collected in a consistent manner based on specific project requirements. Geological data is currently collected directly in digital format using rock type codes. Outcrop mapping data is also collected as required enabling projection of stratigraphic units to surface.

The vast majority of sampling has occurred at 0.5 m intervals. The full drill hole sample is currently collected directly from the cyclone. The sample cyclone is inspected and cleaned at the end of each drill hole to minimise contamination between drill holes. Samples are generally dry but are occasionally wet when the sample is retrieved from below the water table. Where samples are wet, the cyclone is cleaned at the end of each drill rod. CSA Global did not observe the sampling, sample preparation or assaying procedures due to the brevity of the site visit.

No subsampling occurs at the drill rig, other than when a field duplicate sample is collected.

Only mineralised samples are submitted for chemical analysis. Examination of 2012 drill hole data indicates that there is no clear relationship between sample recovery and manganese grade or Yield.

Laboratory sample preparation involves drying the sample followed by jaw-crushing (if required) and then riffle splitting. Two subsamples are taken. The total material in the sample interval is represented by the 'D Assay' based on a 25% split; the 75% of the split is used for the 'A Assay'.

The A Assay subsample is wet-screened using a 0.5 mm mesh (a 1 mm mesh was used from 1979 through 1983). This results in the -0.5 mm fraction being removed from the subsample. The remaining fraction is then dried, riffle split to 200 g and pulverised prior to chemical analysis. The purpose of this subsample is to provide an approximate representation of the Yield (product tonnes) and grade of material which will be recovered after mined ore passes through the site beneficiation circuit.

A Lump and Fines Yield is then calculated from the total Yield by applying a conversion factor based on lithological logging data.

The D Assay subsample is riffle split to 200 g and pulverised. The purpose of this sample is to provide a chemical representation of the *in situ* material.

Historically GEMCO has also used 'B Assay' or 'C Assay' subsamples of the A Assay to define the grade and Yield of the fraction recovered using heavy liquids (a liquid with a specific gravity greater than for example 2.8 will cause the A Assay fraction with a density less than this value to float, so that it can be rejected). An 'E Assay' based on the 1980 Calweld drilling bulk sample program was also used. While data for these assay types (B, C and E) is in the database, and was historically used to predict Yields, it is not currently used for Mineral Resource or Ore Reserve estimation.

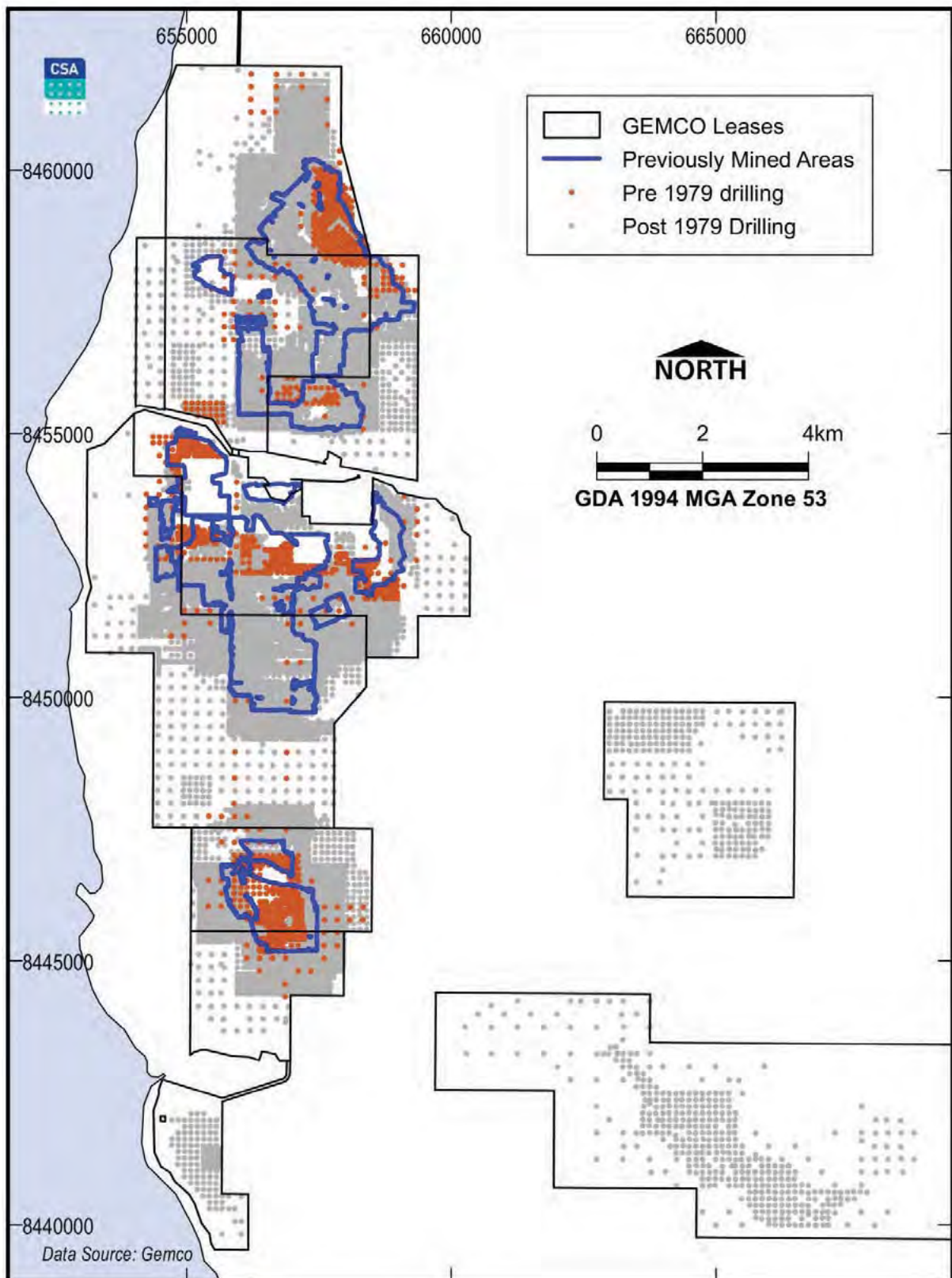

Figure 6 Drill hole location plan

The post 1979 drilling is reverse circulation drilling used for the Mineral Resource estimation

Quality assurance and quality control (QAQC) data has been collected and collated at various stages from 1994 through 2012.

Field QA procedures have primarily involved the collection of field duplicate samples. Field duplicate samples are collected using a single tier riffle splitter at the drill rig. Results for the 2013 drilling program are provided in Figure 7.

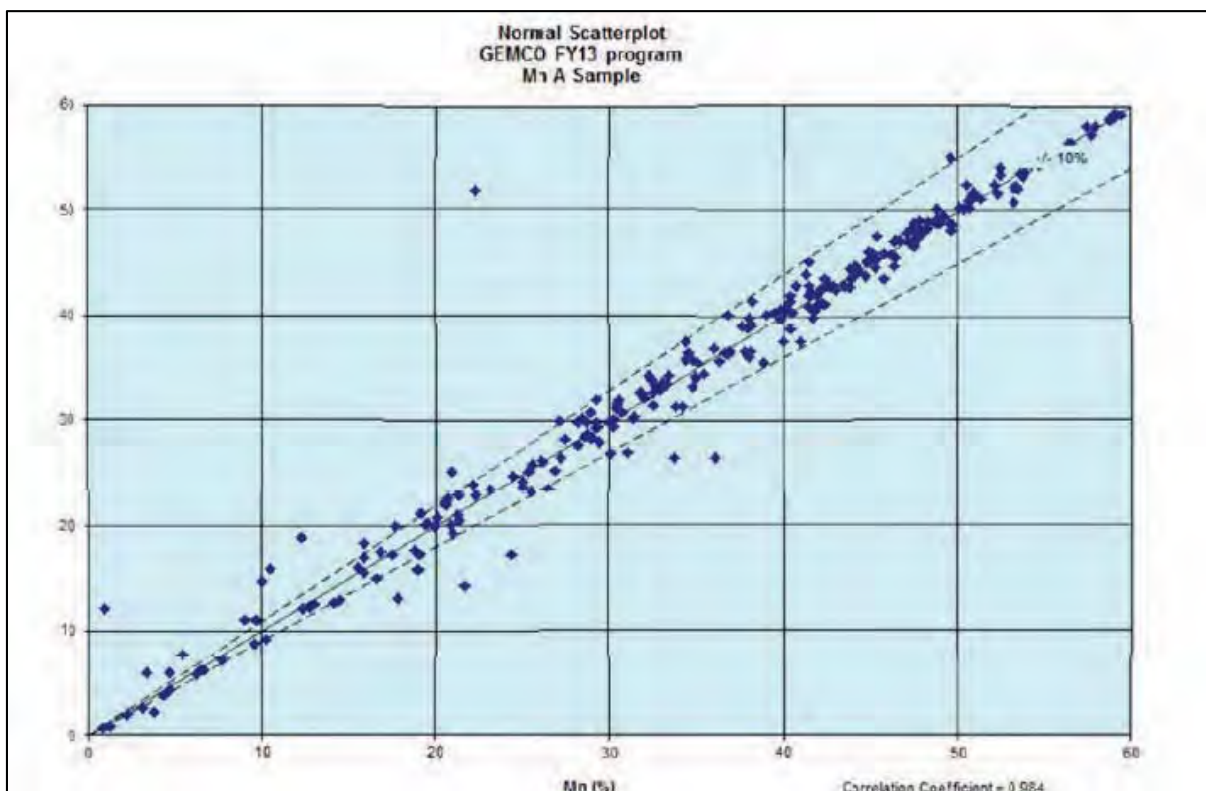

Figure 7 Scatterplot of Field Duplicate results for A assays
Source: Hope and Bryant (2014, Figure 15)

Two non-certified reference materials were created from blast hole samples which were homogenised through repeated quartering and mixing. The site laboratory was used to prepare and analyse the material. When QAQC data has been collected, field duplicates have generally been submitted at a rate of 1 in 30 samples and non-certified field reference materials have generally been submitted at a frequency of 1 in 60 samples. GEMCO has now introduced CRMs at a frequency of 1 in 30.

All samples used in the preparation of the Mineral Resource estimate were submitted to an on-site laboratory. Since 1988 borate fusion with a lithium tetraborate flux has been used to prepare glass beads for determination using x-ray fluorescence (XRF) methods. Analytical methods utilised prior to 1988 are not clear. This represents approximately 20% of the data. Assay values for Mn, Fe, SiO₂, Al₂O₃, P, K₂O, CaO, SrO, BaO, TiO₂, MgO and Na₂O concentrations have been imported into the drill hole database, although not all analytes are available for all samples. The on-site laboratory is accredited by the National Association of Testing Authorities (NATA) and is subject to external audit every 18 months.

Laboratory QA procedures have primarily involved the use of certified reference materials (CRMs), completion of internal repeats and the use of umpire laboratories. CRM and duplicate analyses are

carried out at a rate of 1 in 20 samples. All XRF results which return a greater than 5% total variance are re-assayed. Laboratory repeats for the 2013 drilling program Mn A assays are shown in Figure 8.

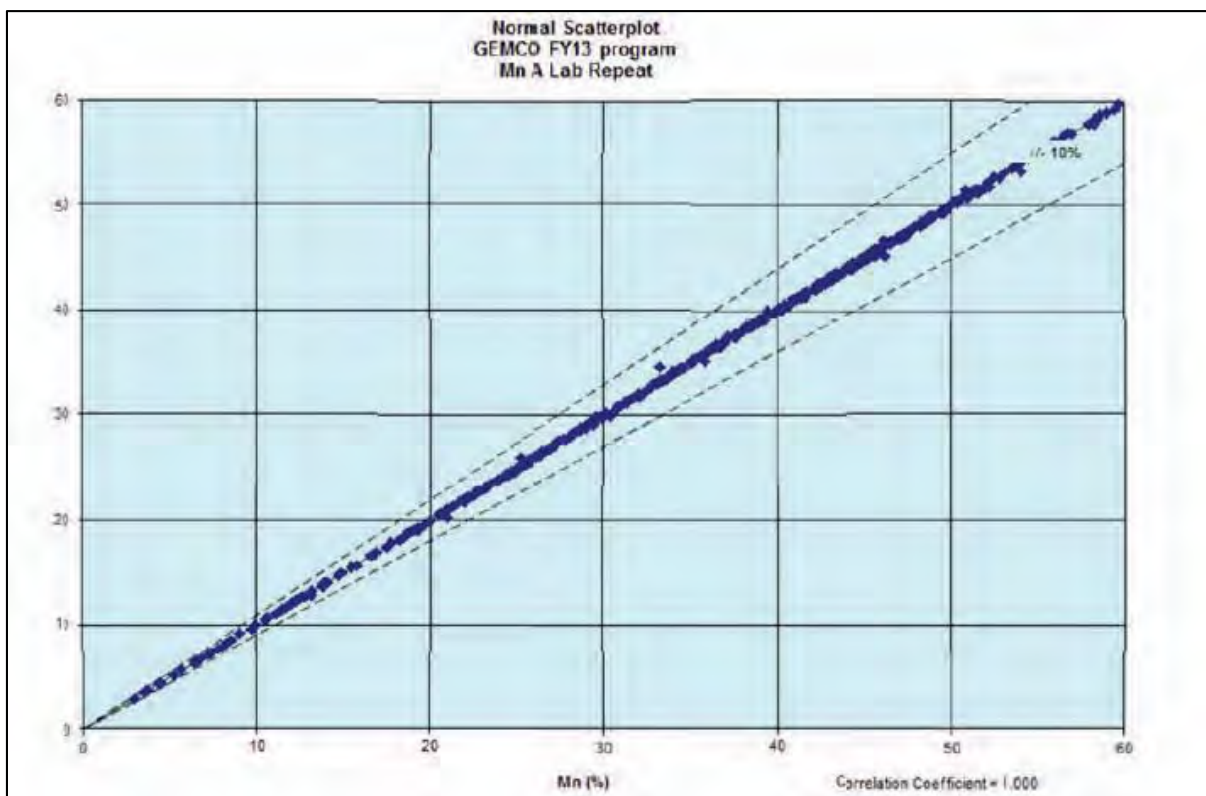

Figure 8 Scatterplot of Laboratory Repeat results for A assays
Source: Hope and Bryant (2014, Figure 16)

CSA Global Assessment

Geological and sampling data has been collected in a manner that has allowed the development of a robust geological model. Discussions with personnel on site provided assurance to CSA Global that the procedures are well understood, appropriate and auditable. Data has been provided to CSA Global for QC samples submitted from 1994 through 2006, 2010 through 2011 and 2012. No material issues were identified with the QA procedures or QC results.

QC data has not been routinely collected over the long-life of the drilling programs. Existing field QA measures involve the submission of field duplicates and non-certified reference materials. All samples are assayed at the site laboratory.

Field duplicate precision results are excellent for the A assays for Mn as shown in Figure 7. Field duplicate accuracy results indicate that for the higher grade (56% Mn) field duplicate there is no bias between the original sample and the duplicate. For the medium grade one (48% Mn) the assayed values are 1.3% Mn higher on average.

In both cases the scatter is predominantly within $\pm 1\%$ Mn. CSA Global considers that the RC sampling is unlikely to be materially biased due to the generally high values of the assays of significance (Mn, Fe, SiO₂ and Al₂O₃), the homogeneity of the ore and the fact that grades are estimated using the A Assay from which dust has been washed.

QC results for laboratory repeats are also excellent for the A assays for Mn as shown in Figure 8.

QC samples have not been routinely collected over the long period of mine development and operation. External CRMs were not submitted at all prior to the current Mineral Resource estimate being completed. Field duplicates have been collected at various times since 1994. Non-certified reference materials have been consistently submitted from 2010 onwards. Only limited non-certified reference materials were submitted prior to 2010.

CSA Global considers that it is not possible to clearly demonstrate the precision and accuracy of the analytical dataset through assessment of the available QC data. However, CSA Global considers that a reasonably high confidence can be placed in the data for the following reasons:

- The data was primarily collected by RC drilling methods which limits the potential for contamination during drilling
- The project has a long mining history, and Lump and Fines product grades broadly support the accuracy of the analytical data (Section 3.4.5)
- The laboratory has long experience in assaying this ore, is NATA accredited and is subject to regular external audits
- Recent QC data is excellent (Figure 7 and Figure 8).

CSA Global considers that the QA procedures, QC data, and production evidence, on the basis of experience with other operating ferrous metal mining operations, and the performance of the GEMCO mine over a long-period, are sufficient to demonstrate that the quality of the sampling and assaying does not pose a material risk to the ongoing development, mining or value of the project. The GEMCO drill hole database can therefore be considered to be of reasonably high quality and provides a sound basis for geological modelling and Mineral Resource estimation.

The key risk associated with the dataset is considered to be the ability of the A Assay to replicate the beneficiation processes. There are two main reasons why the A Assay results can only be regarded as an approximation of Concentrator production.

- The first issue is the effect of the drilling method on the sample. RC drilling accounts for the majority of the drilling database. Most of these RC holes have used a face-sampling hammer whereby sample material is crushed directly at the drill bit face and then moved up through the centre of the hammer. This method should generate more fine fraction material from the harder ore horizons such as Massive Mangite and Cemented Pisolite than exists *in situ*. This should lead to an underestimation of Yield in the A Assay compared to actual ore, although arguably the grade of the generated fine fraction may be the same as that for the remaining +0.5 mm fraction.
- The second issue is that A Assay sample preparation only replicates part of the beneficiation process. The A Assay is a simple wet screen of the original sample using a 0.5 mm mesh. The beneficiation plant includes primary crushing, feed preparation, drum scrubbing and heavy media separation in both the Lump and Fines circuits. The beneficiation plant should therefore be able to recover higher grades than the A Assay and may be expected to produce lower Yields.

A correction is thus required for the overall Yield estimate of Lump + Fines which is derived from the A Assay. This is currently achieved through reconciliation of A Assay estimates with plant production results. This is further discussed in Section 3.4.3.

No information is provided in the CP FY14 report to confirm the validity of the transformation of total Yield estimates from the A Assay to Lump and Fines Yields. In addition, the partitioning of grades (Mn and impurities) between the Lump and Fines fractions achieved in the beneficiation plant (the Concentrator) is not considered in the Mineral Resource estimate. Prediction of the Lump

Yield and grades, and the Fines Yield and grades, are only done at the grade/quality control phase of the mining operation when ore is being dug and sent to the crusher as direct tipped ore, or sent to the Primary Crusher Stockpile (PCS).

3.2.2 Geological Interpretation and Modelling

GEMCO have developed a geological data management system to manage and import drill hole data.

Geological logging forms the basis for geological interpretation. During logging, five alphanumeric rock type fields are available for geologists to populate. Once geological logging is loaded into the central database, these rock type fields are transformed to a lithology code. Validation processes are in place which check for any inconsistencies between geological and analytical data.

Eleven stratigraphic layers have been defined at the GEMCO mine, however all stratigraphic layers may not be present at any given location. The relationship between the stratigraphic layers and the MID and BOT ore horizons are shown in Table 2. The massive mangite, cemented pisolite and oolite, and loose pisolite and oolite stratigraphic layers are combined to form the MID ore horizon. The ferruginous pisolite band is discarded as interburden (INT) if thick enough (>1 m) or mined with the siliceous massive mangite and siliceous cemented pisolite stratigraphic layers which are combined to form the BOT ore horizon. Each of the MID, INT and BOT horizons may not exist within any given hole.

The stratigraphic column at the GEMCO mine is well understood. This has allowed computer scripts to be written which utilise geological and analytical data in the database to provide preliminary boundary locations for ore horizons and then stratigraphic layers.

Table 2 GEMCO stratigraphic layer codes and descriptions

Code	Description of lithologies	Horizon
100	Sandy clays	Overburden
200	Lateritic clays, lateritic sands and laterites	Overburden
300	Concretionary manganese and false ore horizons	Overburden
400	Top massive mangite	MID
500	Cemented pisolite and cemented oolite	MID
600	Loose pisolite and loose oolite	MID
700	Ferruginous pisolite band	BOT
800	Siliceous massive mangite and siliceous cemented pisolite	BOT
900	Disseminated manganese	SUBBOT
1000	Glauconitic sands and clays – main Cretaceous aquifer	Underburden
1100	Proterozoic quartzites and sandstones (bedrock)	Underburden

An ore horizon code is first assigned to drill hole sample intervals in two stages. The first stage involves the generation of a sequence of horizons with a start and end depth in each hole and the second stage involves attempting to identify sequence errors and correct them if required. A stratigraphic code is then applied in two stages. The first stage assigns each interval a stratigraphic code based on geological logging, analytical data and the horizon code that has been previously

assigned. The second stage involves attempting to identify sequence errors and correcting them if required. The system allows for manual override if the geologist deems that the ore horizon or stratigraphic layer codes have been incorrectly assigned during the automated scripting process.

The MID horizon is broadly defined using the following grade criteria based on the A Assay: >40% Mn, <11% SiO₂ and <7% Fe. The BOT horizon is broadly defined using: >40% Mn and >11% SiO₂. An illustrative cross-section is shown in Figure 9 with A Assay Mn grades displayed as colours on the drill hole trace and SiO₂ and Fe grades plotted as numbers on the right hand side of the drill hole

Once the ore horizon and stratigraphic layer data have been validated, data is exported in CSV format for import into Vulcan 3D geological modelling software.

Ore horizon models are critical in that they define the volume of the Mineral Resources reported and constrain grade estimation processes. A file is first generated which contains points for each surface. Known drill hole positions are maintained and points are generated between drill holes on a user-defined grid. These points and additional mapping data points are then used to generate a series of surface triangulations. The geological surfaces that were generated to support Mineral Resource estimation processes are shown in Table 3. All geological features represent the upper contact of an ore horizon or lithological unit.

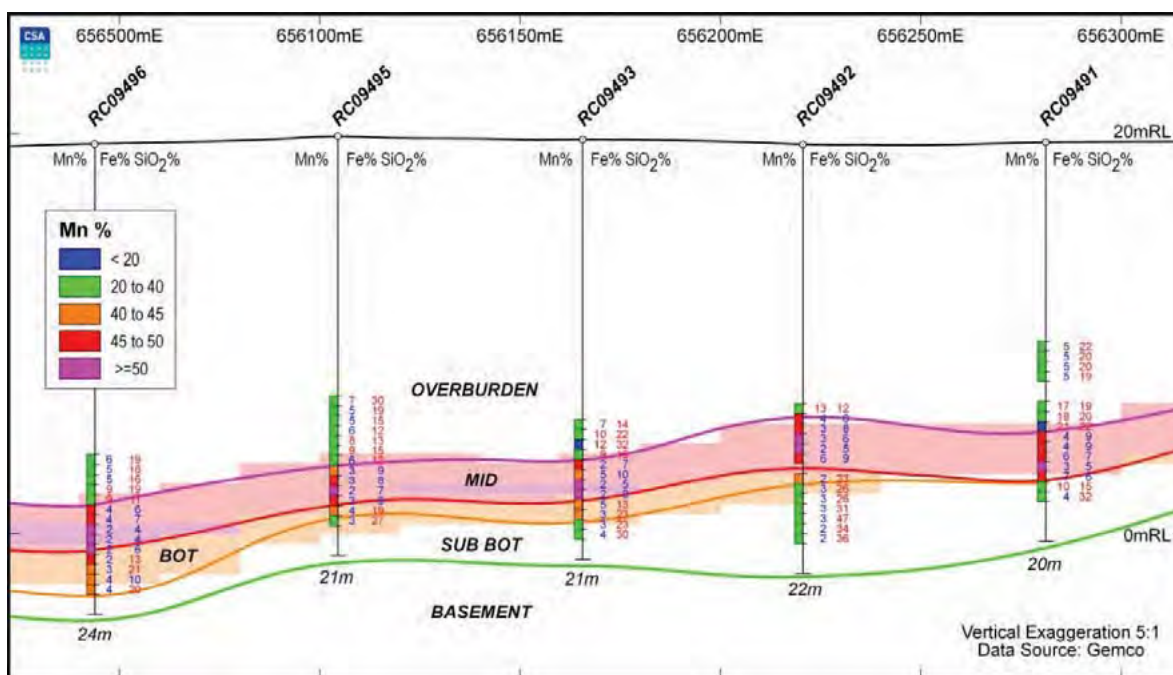

Figure 9 Cross section illustrating the ore horizons in the central part of the deposit
Facing north

Table 3 Surface triangulations

Triangulation name	Feature
grtopo13_tp.00t	Surface topography
gro200_sr.00t	Laterite and lateritic clay
gro300_sr.00t	Concretionary manganese
grm400_sr.00t	MID horizon

Triangulation name	Feature
grb700_sr.00t	BOT horizon
gru900_sr.00t	Disseminated manganese
gru1000_sr.00t	Glauconitic sands and clays
gru1100_sr.00t	Basement quartzite and sandstone

CSA Global Assessment

The GEMCO mine has a long operating history. This has led to a detailed understanding of the sedimentary and subsequent supergene origins of the manganese horizons, and definition of the stratigraphic column which controls the distribution of manganese mineralisation within the sequence.

Geological data collection techniques have been developed specifically for the project. Geological data has been collected in a consistent manner and is sufficiently detailed to allow the accurate modelling of stratigraphic horizons which host the manganese mineralisation.

The automated computer processes that use geological and analytical data to assign ore horizon and stratigraphic codes are considered appropriate for the style of mineralisation. Numerous checks are completed to ensure there are no obvious errors in the database and outputs from these automated processes are valid.

The Vulcan software that has been used for stratigraphic modelling is commonly used in the mining industry. The modules that are used within the software package are considered appropriate to prepare accurate geological surfaces.

Limited visual checking by CSA Global of geological surfaces against drill hole files was completed and no obvious errors were found.

3.2.3 Statistical and Geostatistical Analysis

No statistical analysis of the analytical dataset was completed to assess the requirement for upper grade cuts and none are applied.

Contact analysis has been carried out to assess chemical differences across key lithological contacts. Based on this study, lithological units were combined to form ore horizons, simplifying the grade estimation procedure.

Statistical analysis has been completed to support the definition of domains which define broad geographical regions with similar lithological characteristics. The more recent work completed involved compilation of univariate statistics, assessment of distribution characteristics and analysis of spatial behaviour. Various chemical constituents including Mn, Fe, SiO₂, Al₂O₃ and P were reviewed. Four areal domains have been defined based on geological understanding and statistical analysis as follows:

- Northern Domain, characterised by the influence of lateritisation processes. Primary Mn mineralisation is interpreted to have formed in a shallow marine environment.
- Central Domain, characterised by the lack of influence of lateritisation processes and greater proportion of Fines product. Primary Mn mineralisation is interpreted to have formed in a shallow marine environment.
- Southern Domain, characterised by the influence of lateritisation processes. Primary Mn mineralisation is interpreted to have formed in a shallow marine environment.

- Eastern Domain, characterised by lower grade Mn. Primary Mn mineralisation is interpreted to have formed in an estuarine sedimentary environment.

Geostatistical analysis is done to assess the spatial characteristics of the mineralisation. Experimental variograms were created for A and D sample analytes for the MID and BOT ore horizons within all four areal domains. Variogram parameters derived from this work were used for grade estimation. Manganese variography indicates a low to moderate nugget component, significant short range variability and long ranges (between 1 and 2 km).

CSA Global Assessment

It is considered appropriate that no upper cuts were applied to the data given that no significant outliers exist in the dataset.

The process adopted to define the upper and lower contacts of the zones of economic interest is supported by the analysis of chemical differences at contact boundaries. This work has been carried out in a competent manner by suitably qualified consultants.

Considerable statistical work has been carried out to characterise the broad-scale chemical and lithological differences which exist across the deposit. This has led to the definition of four separate domains which form the basis of current geostatistical work. This work has been carried out in a competent manner by suitably qualified consultants.

Geostatistical analysis was completed in 2010 based on drill hole data available at that time. While the estimation parameters should be revised when significant drilling is completed (such as from 2010 through 2012), the parameters are likely to remain consistent. Alternative approaches have been tried in the past such as unfolding of each of the stratigraphic horizons, and are to be again implemented in FY15.

3.2.4 Estimation of Mineral Resources

Drill hole samples were composited to 0.5 m prior to grade estimation.

Grades were estimated into blocks from drill hole data using Ordinary Kriging. Soft boundaries were used between the areal domains and hard boundaries were used between ore horizons.

Interburden horizons were not modelled separately nor estimated as a separate grade domain on the basis that they are spatially discontinuous. The influence of interburden samples was reduced by applying a maximum distance from the block centroid, where they are used in the kriging. Beyond the maximum distance, they are applied a kriging weight of 0 and therefore ignored during grade estimation. The maximum distance was set to 10 m.

Mn, Fe, SiO₂, Al₂O₃, P, BaO, K₂O, MgO, Na₂O, CaO, SrO and TiO₂ were estimated into blocks for both the A and D sample in addition to the Yield.

Quantitative kriging neighbourhood analysis (QKNA) was completed in 2004 and 2010 to optimise search parameters. The search parameters shown in Table 4 were adopted for the Mineral Resource estimate following the 2010 study.

Table 4 Search neighbourhood parameters

Domain	Ore horizon	Variables	Primary search ellipse	Min / max samples	Secondary search ellipse	Min / max samples
2,3,4	MID	A and D Assays	400 m X by 400 m Y by 4 m Z	8/32	1,000 m X by 1,000 m Y by 10 m Z	4/32
		Yield Variables	400 m X by 400 m Y by 4 m Z	8/20	1,000 m X by 1,000 m Y by 10 m Z	4/20
	BOT	A and D Assays	400 m X by 400 m Y by 4 m Z	8/32	1,000 m X by 1,000 m Y by 10 m Z	4/32
		Yield Variables	400 m X by 400 m Y by 4 m Z	8/20	1,000 m X by 1,000 m Y by 10 m Z	4/20
6	MID	A and D Assays	400 m X by 400 m Y by 4 m Z	4/32	1,000 m X by 1,000 m Y by 10 m Z	4/32
		Yield Variables	400 m X by 400 m Y by 4 m Z	4/20	1,000 m X by 1,000 m Y by 10 m Z	4/20
	BOT	A and D Assays	400 m X by 400 m Y by 4 m Z	4/32	1,000 m X by 1,000 m Y by 10 m Z	4/32
		Yield Variables	400 m X by 400 m Y by 4 m Z	4/20	1,000 m X by 1,000 m Y by 10 m Z	4/20

All block modelling and grade estimation was carried out using 3D geological modelling software. The impact of block size on kriging variance was examined by a Selective Mining Unit study in 2004. This was used to justify the selection of parent cell sizes which are shown in Table 5. Discretisation was set to 6 points in the X and Y dimensions and 1 point in the Z dimension resulting in 36 nodes per parent cell. An octant based search was used for the primary search pass whereby a maximum of four composites were allowed per octant. No octant based search was set for the secondary search pass and subcells were assigned the grades of parent cells.

Table 5 Block model parameters

Parameter	X	Y	Z
Parent block size (m)	120	120	0.5
Subcell size (m)	20	20	0.5
Block model minimum	653,000	8,439,500	-140
Block model maximum	660,400	8,462,300	120
Total parent cells	140	190	520

Dry *in situ* bulk density values were derived after analysis of density measurements taken on diamond drill core using water immersion methods. Density was assigned after analysis of this data according to Domain and stratigraphic code. Adopted density values are shown in Table 6. Non-ore

density values are not tabulated: material above the ore has values between 1.50 and 1.75 t/m³; material below the ore has values between 1.65 and 2.00 t/m³.

Table 6 Density assumptions

Ore Horizon	SG domain	Resource estimation domain	Dry bulk density (t/m ³)
MID	1	2	2.80
	2	2	2.80
	3	3	2.50
	4	4	3.07
	5	4	2.45
	6 & 7 (Eastern Leases)	6	2.15
BOT	1	2	2.55
	2	2	2.55
	3	3	2.40
	4	4	2.78
	5	4	2.30
	6 & 7 (Eastern Leases)	6	1.95

Block model validation following estimation involved: visual comparison with drill hole data; creation of swath plots to compare drill hole and block model mean grades for slices throughout the deposit; and comparison of drill hole and block model domain statistics.

CSA Global Assessment

The sample compositing interval is appropriate given the vast majority of data is collected at the chosen interval of 0.5 m.

The use of Ordinary Kriging is valid as there are no significant outliers in the dataset for the primary chemical constituents of interest.

Yield is a geometallurgical attribute rather than an *in situ* property of the rock and so is subject to the well understood theoretical concerns of *in situ* estimation. Conversions are used to estimate Lump and Fines Yields from the total Yield as predicted from the A Assay recovered weight. Block **I_yield** and **f_yield** values are weighted linear combinations of converted A Assay recovery values and so are considered by site to be coarse predictors of the Yields that can be expected from beneficiation in the GEMCO Concentrator.

The use of hard boundaries between ore horizons is considered appropriate given the different chemical characteristics of the two main ore horizons, which has been confirmed as valid through contact analysis.

Chemical differences across the deposit region have also been studied and this has led to the definition of four areal Domains. Soft boundaries have been used between these Domains, allowing grade estimation processes to use data either side of the boundary. This appears to be a reasonable approach given that these boundaries are not hard geological features and have been generalised from regional statistical differences. Local estimation quality has been improved by the soft boundary approach allowing the use of additional samples across the boundary positions.

The limitation applied to samples which are flagged as interburden does not appear reasonable. This has been done to reduce the influence of poorly predicted splits between the Mn horizons, however it will create a positive Mn bias within the block model ore horizons. This is not considered a material issue given that the mining of the deposit is well understood and ore control practices attempt to separate interburden material where the thickness or extent is significant, or there is very little ore underneath.

Detailed variography was completed in 2004 and again in 2010 to characterise the spatial variability of the grades and Yield. Variography was completed within each areal Domain and ore horizon. Variogram parameters derived from the 2010 study were adopted for Ordinary Kriging in the CP FY14 Mineral Resource estimate. Although the 2010 work is now out of date, in that additional data could have been used to update the study, the variogram parameters that were derived from the 2010 work are likely to remain reasonable given that the more recent data only represents a small portion of the total dataset. CSA Global completed limited checking of the experimental variograms that were generated in the studies carried out in 2004 and 2010 studies and found those for Mn, Fe, SiO₂, P, Al₂O₃, K₂O and MgO to be of reasonable quality.

The QKNA studies in 2004 and 2010 support the search neighbourhood strategies, which appear to be appropriate and well considered.

The horizontal block size of 120 m by 120 m is considered to be large given that much of the deposit has been drilled on a 60 m by 60 m grid. Further studies are required to quantify the impact of a reduction of block size on the reported global Mineral Resources and local grade estimates. This is not considered a material risk to the reported Mineral Resources.

While QAQC checks on density (including using an alternative testing method) were not provided, CSA Global considers that the history of mining production means that the operation should have good data to validate the densities adopted and the values provided are accepted. Density values assigned to the block model on the basis of lithology and areal Domains are likely to be relatively accurate on a global basis given the quantity and quality of available density data.

Limited visual checking of the block model against drill hole files was completed and no obvious errors were found. Drill hole and block model statistics were also compiled for each Domain. The block model grades compare well with the drill hole grades. This gives confidence that Mineral Resource estimation procedures have been implemented successfully.

Overall, the model is accepted as appropriate based on the current bulk mining of the MID and BOT ore horizons.

3.2.5 Mineral Resource Classification and Statement

The Mineral Resource estimate has been classified in accordance with the JORC Code (2012).

The database was closed in May 2013 and included all results from drilling completed in December 2012. No 2013 drilling is included in the database used for the current CP FY14 Mineral Resource estimate. Mineral Resources have been classified based primarily on drill spacing. Digital files were created to delineate areas where drill patterns have been achieved which were deemed by the Competent Person to be sufficient to classify Measured, Indicated and Inferred Mineral Resources. The adopted Mineral Resource classification system is shown in Table 7 and boundaries are shown in Figure 10.

Only the MID and BOT ore horizons were reported and horizons less than 1 m thick were excluded. No cut-off grade was applied when reporting material within the MID and BOT ore horizons, which are defined using A Assays greater than 40% Mn and other grade criteria (see Section 3.2.2).

Table 7 GEMCO Mine Mineral Resource classification

JORC Code (2012) classification	Drill spacing
Measured	Less than 60 m E by 120 m N
Indicated	Less than 120 m E by 120 m N
Inferred	Less than 240 m E by 240 m N

Mineral Resources at 30 June 2014 are reported in Table 8 and include the Eastern Leases. The Mineral Resources are inclusive of the Ore Reserves. There is potential to define Mineral Resources beneath the base of the BOT ore horizon, in the SUBBOT horizon, however this section of the sequence has not been representatively sampled by drill holes and is not currently regarded as recoverable.

Table 8 GEMCO Mine Mineral Resources at 30 June 2014

JORC Code (2012) classification	Tonnage (Dry Mt)	Grade A Assay (Mn %)	Yield (%)
Measured	94.6	46.1	48
Indicated	46.3	43.6	47
Inferred	33.5	42.7	49
Total	174.5	44.8	48

GEMCO Mineral Resources depleted to 31 December 2014, using production until 31 October and forecast production in the subsequent two months, are reported for a minimum ore thickness of 1 m above a 40% Mn A Assay grade. The Grade and Yield represent the expected concentrator results for the washed product. The Mineral Resource estimate is provided in Table 9.

Table 9 GEMCO Mine Mineral Resources depleted to 31 December 2014

JORC Code (2012) classification	Tonnage (Dry Mt)	Grade A Assay (Mn %)	Yield (%)
Measured	90.1	46.0	48
Indicated	46.3	43.6	47
Inferred	33.5	42.7	49
Total	169.9	44.7	48

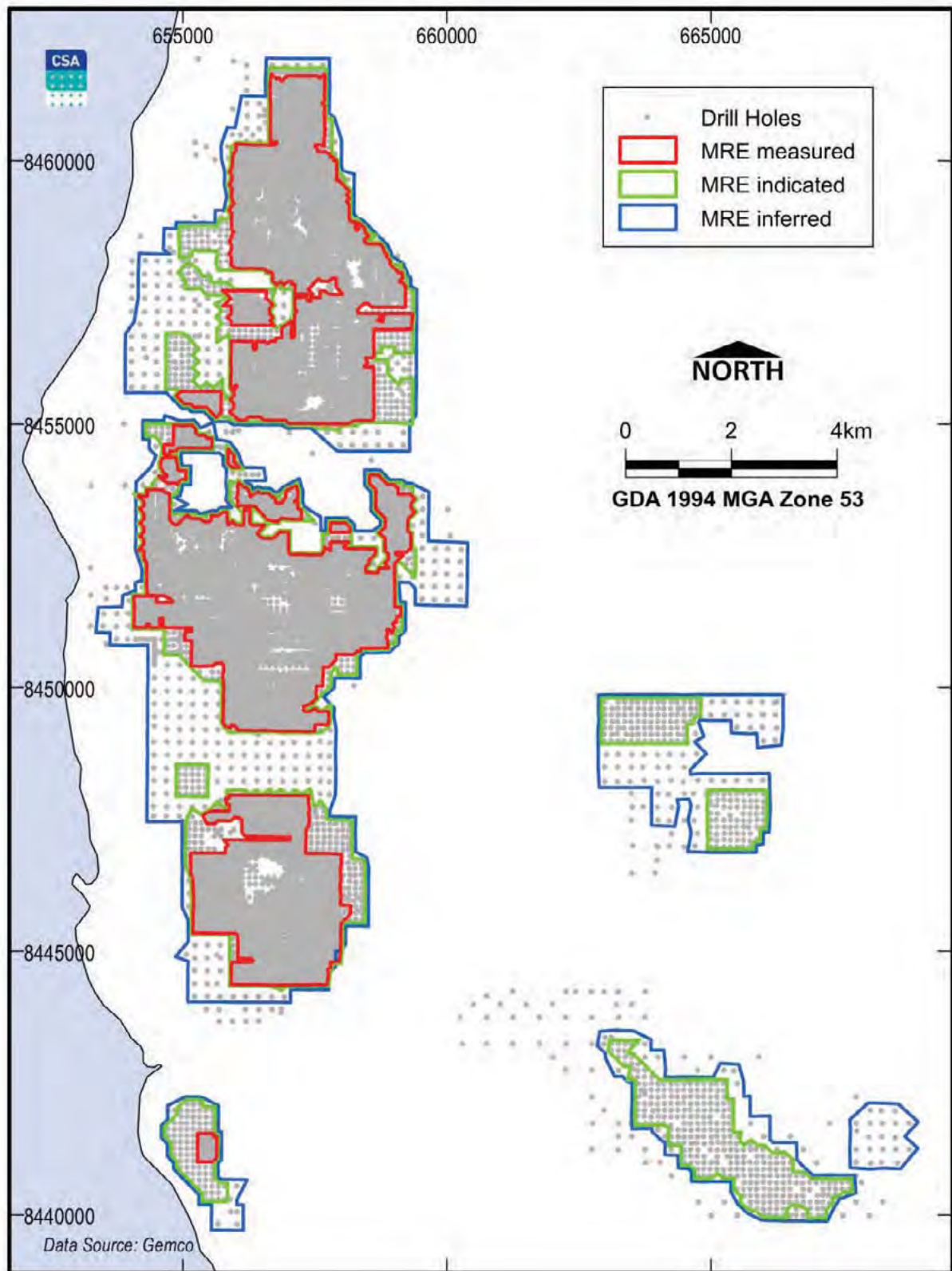

Figure 10 Mineral Resource classification boundaries

CSA Global Assessment

CSA Global was able to reproduce the Mineral Resource estimate from data provided, indicating the audit trail is robust and validating the Mineral Resource reporting procedures.

The following key assessments were made prior to forming an independent judgement on Mineral Resource confidence:

- The quality of the input drill hole data is considered to be reasonably high and provides a sound basis for geological modelling and Mineral Resource estimation.
- Controls on the mineralisation are well understood. Significant effort has been placed on recording relevant geological data in a consistent manner and systems have been established to build 3D stratigraphic models which can be considered to be accurate. Geological continuity of the MID and BOT ore horizons is locally variable but overall the deposit shows remarkable consistency and conformity with the stratigraphic model.
- Variography has been completed to describe the spatial behaviour of the variables estimated. Manganese variography results display a low to moderate nugget component, significant short range grade variability and a long range.
- A risk in the Mineral Resource estimate is considered to be the ability of the A Assay to replicate the beneficiation processes. Reconciliation results during the last two years (see Section 3.4.5) have been used by site personnel to determine Yield conversions which are applied when converting the Mineral Resources to the Ore Reserves. Thus this risk is monitored, and moderated by factoring, so it is not considered by CSA Global to have a material impact on the Ore Reserves derived from the Mineral Resources.

After due consideration of data integrity, geological continuity and grade continuity, the classification categories that have been applied are considered reasonable given the drill spacing achieved.

3.2.6 Sand Tailings

In addition to the *in situ* Mineral Resources reported in Section 3.2.5, GEMCO has prepared a Mineral Resource estimate for sand tailings (Hope, 2014) which exist in dams and stockpiles on the mining leases.

Sand tailings are currently produced as a waste product from the beneficiation plant. Sand tailings are a mixture of slimes and sand sized particles and comprises manganese (pyrolusite and cryptomelane) and silica sands with kaolinite and goethite as gangue minerals. Analysis of the sizing distribution in drill hole samples indicates 97% of material is below 2 mm in size.

Dimensions of the tailings storage facilities vary from 140 m by 300 m to 860 m by 420 m and the depth varies from 3 m to 15 m.

There were 124 vertical push probe drill holes for 1,472 m completed to sample the sand tailings. Drilling was completed on a 60 m X by 60 m Y grid and three stockpiles and one dam were tested.

Drill hole collars have primarily been survey located using a DGPS after completion of drilling. The drill holes are shallow and vertical hence downhole surveying is not carried out. All drill holes are less than 20 m.

Drill hole samples were collected every 1 m for geological logging. Each 1 m interval was split using a single tier riffle splitter and all splits were combined (composited) for a drill hole. A single composite sample was submitted for each hole to Bureau Veritas in Adelaide for XRF analysis.

Samples were generally moist to wet. A split of the original composite sample was analysed in addition to the fractions sized at -45 micron , 45 micron to 2 mm and +2 mm. In addition, Loss On Ignition (LOI) was determined and gas pycnometry was used to determine particle density.

No Field Duplicate QC samples were submitted with the drill hole samples. Laboratory QA procedures included the use of CRMs and analysis of internal repeat samples.

Data collected during the drilling program was stored in a database prior to being exported to CSV format for import into the 3D geological modelling software. Validation exercises were completed within the database and Vulcan software.

No upper cuts were applied to the data.

Topography and basement surfaces were modelled using Vulcan software.

A volume block model was created using techniques which lead to an accurate representation of the volume in the Z direction. This ensured that the basement and surfaces were honoured with a high degree of accuracy.

Grade estimation was carried out using the inverse distance squared technique with the maximum search distance set to 200 m.

A dry *in situ* bulk density of 1.8 t/m³ was assigned to the block model on the basis of pilot plant test work.

Prior to completing the Mineral Resource estimate, a reflux classifier plant was set up to process the sand material. A bulk sample of 17,000 t was processed to produce 6,500 t of concentrate which has been shipped to potential customers for test work.

Mineral Resources have been classified in accordance with the JORC Code (2012) based on drill spacing. The adopted Mineral Resource classification system is shown in Table 10. The Mineral Resource estimate for the Sand Tailings is reported in Table 11.

Table 10 GEMCO Sand Tailings Mineral Resource classification method

JORC Code (2012) classification	Drill Spacing
Measured	-
Indicated	Less than or equal to 60 m E by 60 m N
Inferred	Greater than 60 m E by 60 m N

Table 11 GEMCO Sand Tailings Mineral Resources

JORC Code (2012) classification	Tonnage (Dry Mt)	Grade D Assay (Mn %)
Measured	-	-
Indicated	12.8	20.8
Inferred	2.3	20.0
Total	15.0	20.7

CSA Global Assessment

The techniques adopted to prepare a Mineral Resource estimate for sand tailings which exist at the GEMCO mine site are considered reasonable. The reported Mineral Resource estimate is likely to be a reasonable global approximation of the sand tailings material which exists on the mine site.

Based on the information supplied, there are no drill holes completed in the areas classified as Inferred. The Inferred Mineral Resource only constitutes 2.29 Mt (15%).

A small Mineral Resource of 15.0 Mt with an *in situ* grade of 20.7% Mn has been defined by the Sand Tailings Project. With further test work and the demonstration that the bulk sample has produced a saleable product it is likely that the Mineral Resources for the Sand Tailings will be defined as an Ore Reserve in future. It is not considered in the Valuation of Ore Reserves by CSA Global (Section 4).

3.3 Mining

3.3.1 Major Facilities

Facilities on site owned and/or managed by GEMCO at Groote Eylandt include:

- 5.9 Mtpa (product) ship loader
- 5.0 Mtpa (product) beneficiation plant (the Concentrator)
- The Alyangula Township that can accommodate approximately 2,000 people
- All-weather landing strip capable of 100 seat aeroplanes (Groote Eylandt Airport).

3.3.2 Mining Method

Open pit mining has been carried out at Groote Eylandt since production commenced in 1965. The manganese orebody is relatively thin and tabular, overlain by up to 20 m of overburden. The ore thickness varies from 0.5 m up to 6.0 m.

The ore is removed by a process known as 'strip mining' which involves the use of dozers, drilling and blasting, excavators and trucks. Mine design is done in Vulcan 3D mining software based on strips that are 40 m wide and up to 1,200 m long, subdivided into 200 m long cuts. Mine optimisation is performed on a strip basis using BHP Billiton's proprietary optimisation tool Blasor.

After removing vegetation the top soil is moved onto completed mining areas ready for rehabilitation or stockpiled for later recovery. Mining is done with excavators and/or loaders, combined with haul trucks, removing the overburden to within 15 m of the expected top of mineable ore. Dozers are then used to push the remaining overburden onto the adjacent mined-out strip. The ore is mined using an excavator and trucks by top-loading. After the mined strip is back-filled (with overburden from the adjacent strip) the topsoil is replaced and revegetated. Figure 11 illustrates the mining sequence.

The use of dozers enables removal of the overburden material that comprises laterite and sandy illite/kaolinite clays that can be sticky when wet. Historically mining used scrapers for overburden stripping but the dozing sequence has proved highly efficient and the number of dozers is now built into the mine planning optimisation procedures as a capacity requirement. Available trucks exceed the truck haulage requirements and provide significant back-up for unplanned maintenance, necessary due to the remoteness of Groote Eylandt and access to supply heavy equipment only by ship/barge.

Depending on ore requirements the decision can be made to mine the orebody in a single pass or split and mine the MID and BOT horizons separately. The rock-types in these are predominantly:

- MID – high grade Mn ore consisting of massive mangite; cemented and loose pisolite; and cemented and loose oolite
- BOT – massive siliceous mangite and massive mangite.

The significant increase in Concentrator and Shiploader capacity (the latter 2.8 to 5.9 Mtpa in five years) has meant that mining has evolved from more selective methods to a bulk mining method where the upper overburden is taken to within 15 m above the ore horizon with an excavator. The remaining overburden is then pushed downwards, across and then upwards to uncover the ore and recover the adjacent mined-out strip. This is done with a series of dozers until the orebody is exposed ready for drill and blast.

Excess rainfall during the wet season is handled by scheduling mining where the ore is at higher levels and through dewatering in advance of mining. This has an impact on the short term mining schedule but not on the Ore Reserves.

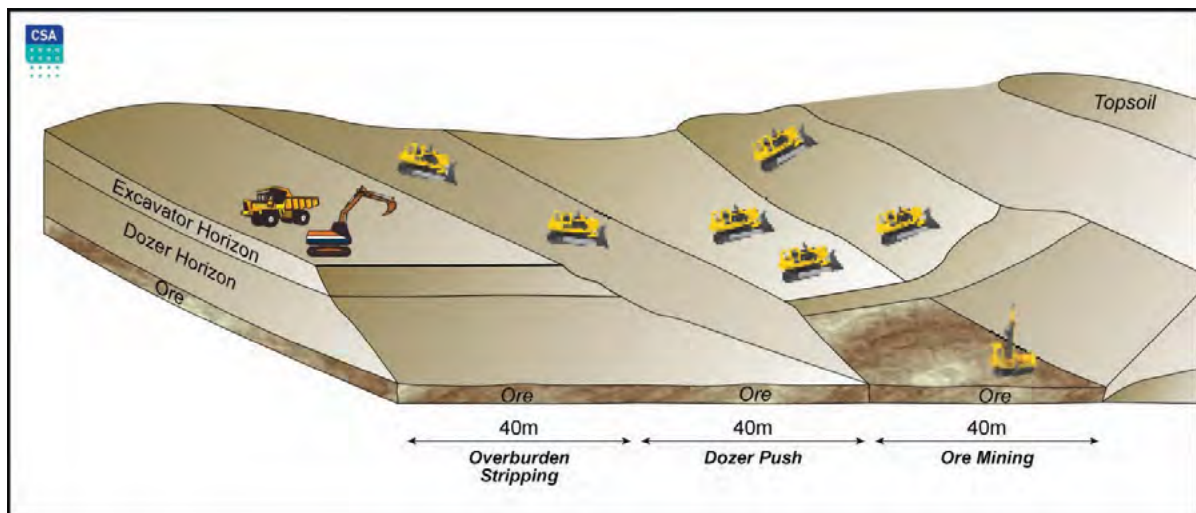

Figure 11 Illustration of the stages of strip mining on GEMCO's mining leases

3.3.3 Mine Production and Equipment

Mine production is based on the requirements of the Concentrator in terms of capacity and ore types. The Concentrator currently has an annual feed capacity of 9.5 Mtpa, planned to rise to 10.0 Mtpa in FY19.

The mining equipment available is sufficient for requirements and includes:

- Hitachi EX2500-6 excavators (250 t) x 3
- Sandvik drill rig x 1
- Caterpillar 777F haul trucks (95 t) x 29
- Caterpillar D11R dozers x 13
- Caterpillar FEL993K loaders x 3
- Kenworth road trains each hauling 200 t in four belly dump trailers x 8.

3.3.4 Mine Infrastructure

The mining is straightforward, complicated only by the requirement to have a large number of mining pits (Quarries) with open mining faces. This enables feeding consistent grades to the Concentrator by blending from uncrushed ore stockpiles and direct tipping.

Facilities to support mining include the haul roads, mobile plant workshops, explosives storage, and planning offices. A significant proportion of equipment operators and planning staff work on a fly-in, fly-out 7 day roster.

3.3.5 Rock Mechanics and Dumping

A geotechnical study was carried out by consultants in 2010 which recommended a maximum final wall slope of 60°; currently all mining areas are well within this guideline. Typically dozers work to a high-wall slope of 15 to 20° and a side-cut slope of 45° on the opposite wall. The main geotechnical risk on site is with the side walls. Undercutting these could result in localised failures making marginal ore inaccessible, but given the shallow depths of the pits it is considered that the impact of such failures on the Ore Reserve is negligible.

Mining of the thickest parts of the deposit with the thinnest overburden in the early years means that there is no requirement for permanent external waste dumps. As the strip mining process means overburden material is returned to within the final pit limits once the ore is extracted.

3.3.6 Processing

The operation is a producing mine that has been mining, beneficiating and selling product for a considerable period of time. Given that there is no expected change in the ore types or the beneficiation plant, the best indication of the future performance of the operation in upgrading the mined ore to saleable product is the historic performance of the plant (Table 12). Since 2006 the Yield has fluctuated within 2% of the average of 50.3% reported by GEMCO on a wet/wet basis. Yields for Ore Reserves (and discussed in this CSA Global report) are all reported on a dry/dry basis. As noted in Section 3.4.6 the moisture contents are assumed to be around 10%.

Table 12 Historic performance of the Concentrator since FY06

Year	Yield (%) (wet/wet basis)
FY06	52.50
FY07	51.33
FY08	50.11
FY09	49.18
FY10	48.27
FY11	51.96
FY12	48.84
FY13	52.00
FY14	48.16

Issues of mineral processing, metallurgy and geometallurgy are not further considered as there is no evidence of changes that would impact on the Ore Reserves as Modifying Factors affecting the processing of the manganese ore.

Ore is hauled from the mining Quarries for direct tipping into the crusher, or for stockpiling at the PCS. The Concentrator first separates material by a crushing, screening and scrubbing stage that removes the undersize portion (less than 0.5 mm, predominantly sands and clays) which goes to the TSF. The +0.5 mm material reports to the Heavy Media Separation (HMS) facility.

Beneficiation produces both Lump (11 to 75 mm) and Fines (0.5 to 11 mm) products which are stored in bins before road haulage to the Port stockpiles. The ore types fed to the Concentrator and the resulting Lump and Fines products are referred to interchangeably as:

- GL (Groote Lump) – requires full HMS separation
- BPL (Bypass Lump) – requires size separation only
- MF (Metallurgical Fines) – requires full HMS separation
- BPF (Bypass Fines) – requires size separation only

The GEMCO beneficiation plant was commissioned in 1972 at a rate of 1.0 Mtpa product. Over the past 5 years GEMCO has progressively expanded shipping of product from 2.8 Mtpa in FY07 to in excess of 5 Mtpa in FY13. The Groote Eylandt Expansion Project 1 (GEEP1) increased capacity to 4.2 Mtpa of product by increasing feed capacity to between 5.0 and 5.5 Mtpa (wet), so that the production bottleneck became the road haulage. GEEP2 took the capacity of the Port and road haulage to 5.9 Mtpa, and increased the Concentrator capacity to 4.8 Mtpa by installing a bypass unit around the heavy media circuits. The Concentrator is scheduled at 5.0 Mtpa in the FY15 LoA plan, having lifted the HMS capacity and shifted the bottleneck back to feed preparation. Incremental improvements in the Concentrator are expected to further increase availability at the optimal production rate. The Concentrator currently has a nominal feed rate of 1,400 tph, i.e. an annualised rate of 9.5 Mt of ore.

G Quarry (Fines) is not considered a Concentrator product. It is only screened prior to shipping and has grades around 40% Mn.

3.3.7 Tailings

Undersized material (minus 0.5 mm) from the Concentrator is sent to a number of TSFs. Tailings are approximately 50% sands and 50% slimes sized materials. The TSFs are constructed as required to meet the needs of the operation and there is no constraint on available land. The latest TSF construction is on the site of the old A South Quarry.

GEMCO engages a suitably qualified independent tailings engineer to visit the site quarterly to perform inspections, and annually for risk assessment of both operational and historic facilities, to ensure tailings facility performance and integrity. TSF11 is a planned long term slimes TSF currently being constructed to provide additional slimes tailings storage capacity in accordance with LoA plan requirements.

CSA Global has been advised that going forward the Optimised Base Plan will include an integrated TSF strategy to ensure no sterilisation of the Mineral Resources occurs and to minimise capital costs. This will include improvements in dam planning and construction using the site mining fleet. This is supplemented by a Tailings Management Study for the FY17 LoA to further optimise the TSF strategy over the life of the mine.

3.3.8 Water

The groundwater table on the GEMCO leases is usually 5 to 10 m below the ground surface. Groundwater levels are affected by seasonal recharge, most often during the wet season by direct

rainfall. Water is predominantly stored in mined-out pits that act as backup water for the Concentrator. Excess water that cannot be directed to the Concentrator or mined-out pits is infrequently pumped to nearby vegetation areas. The groundwater model estimates dewatering rates up to 45,500m³/day (0.5 l/sec) in the northern Quarries and 23,500 m³/day (0.25 l/sec) in the southern Quarries.

In the short-term, excess rainfall can have a significant impact on the mine schedule. This is balanced on site by the flexibility to move to other available mining faces that remain open and operable. This does not have a material impact on the Ore Reserves because the mine schedule can be altered to suit ground conditions. While on site it was noted that the excavator and truck combination was removing only the top 3 to 5 m of overburden. This allows the trucks to remain above the water table and the sticky floor conditions below are comfortably managed by the dozers.

3.4 Ore Reserves

3.4.1 Mining Impacts on the Ore Reserves

There have been refinements and improvements over the course of mining the Groote Eylandt manganese deposit since the 1960s, but the practices are considered to be at a level that is appropriate and suitable for the site. The bulk mining approach, and de-bottlenecking throughout the chain of production, have created significant production efficiencies and cost-reductions. While this has reduced the planned mine life based on the current Ore Reserves, it is considered unlikely that more selective mining methods to produce specialty products could add more value. Any future mining method changes are likely to occur only if they are proven to be cost beneficial. Significant changes to the GEMCO mining method are unlikely and are therefore considered not to impact on the Ore Reserves.

Mining limits are set at a minimum of 10 m from the lease boundary to the pit crest. The Ore Reserves are based on a standoff distance of 50 m from populated areas but special arrangements and on site management will be required to recover any ore closer than 500 m. Proposed mining areas are inspected by the Traditional Owners and can be sterilised for various reasons, potentially at short notice. These are defined and monitored by GEMCO's External Affairs team and may result in some disruption to the short-term scheduling (as has happened in A Quarry) but they do not materially impact on the Ore Reserves. Identified sacred sites are excluded from mining; their standoff distance is by agreement with various authorities and site management. None of these local mining adjustments pose a material risk to the Ore Reserves.

3.4.2 Life of Asset

The current Ore Reserve statement by GEMCO (CP FY14), declared on 30 June 2014, is based on the FY15 LoA (BHP Billiton, 2013) using the Optimised Base Case. The mining schedule that drives the LoA was created in the LoAstratiform version of Blasor (BHP Billiton's own software), which optimises Net Present Value (NPV) under various production constraints using the CPLEX optimisation engine. The 2013 Mineral Resource model was used with Modifying Factors applied as discussed in Section 3.4.6.

The Blasor outputs are in annual 'buckets' and these are the basis for all long-term mine planning. Figure 12 shows the LoA mining extents using a colour schematic for each year.

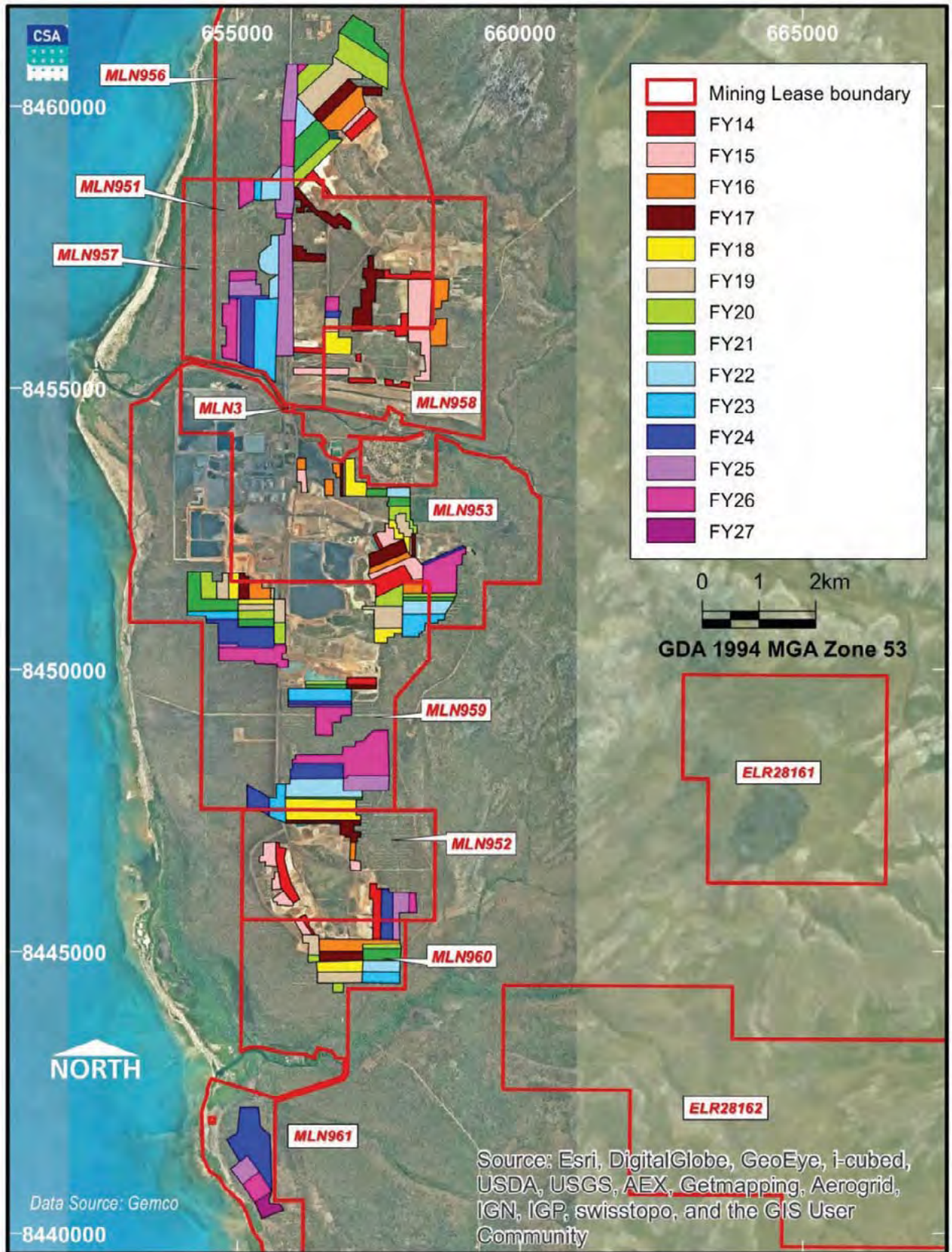

Figure 12 Western side of Groote Eylandt showing GEMCO planned annual mining 'buckets' for the Life of Asset plan, as optimised using Blasor, and lease boundaries.

The LoA production schedule developed by GEMCO is shown in Figure 13.

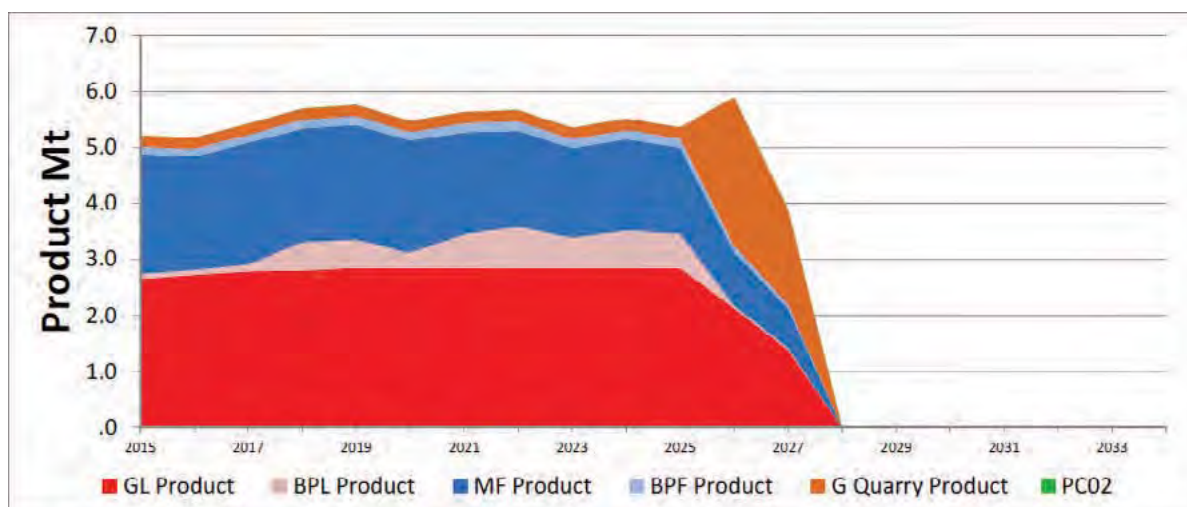

Figure 13 Life of Asset production profile by expected saleable product type

Source: GEMCO. Note that G Quarry production was excluded from the CSA Global valuation

The Ore Reserves assume a 40% washed Mn product cut-off grade and a minimum ore thickness of 1.0 m. Current site practice demonstrates that ore down to 0.5 m thickness can be mined successfully, but these mining blocks are not reported in the Ore Reserves.

The mined ore horizons contain significant material below the 40% Mn product grade which is washed out during the beneficiation process. A study completed in 2013 demonstrated that the 40% cut-off grade is appropriate for use in the Ore Reserves. CSA Global considers that the current cut-off grade of 40% Mn is suitable because there is little improvement to NPV by lowering the cut-off grade. The potential of stockpiling such lower grade material (including recovering SUBBOT material) is reviewed periodically by GEMCO as part of their opportunity assessments.

3.4.3 Yields in the Mineral Resources and Ore Reserves

The Mineral Resource model contains estimates for *in situ* grades based on the D Assay (as Mn % and minor elements). Predictions of product grades are based on the A Assay which is derived from sample weights before and after wet screening at 0.5 mm. The D Assays, A Assays and A Assay Yields are treated as grade variables in the Ordinary Kriging process of resource estimation. The Lump Yield and Fines Yield are assigned by factoring the A Assay Yield using a look-up table for the logged rock codes and the Quarry area, based on a historically established relationship. The *in situ* densities used for the Ore Reserves are those defined in the Mineral Resource estimation process based on diamond core test work (see Section 3.2.4, Table 6).

As there are no separate assayed estimates of the Lump grade and Fines grade from drill sampling, the same A Assay grade is used for both. While this does not reflect the actual partitioning of grades into Lump and Fines products (which do show minor differences in Mn, SiO₂, Al₂O₃, and P), it has been found that the grade differences are not significant and these are not factored in producing the Ore Reserves from the Mineral Resources.

Reconciliations have shown an ongoing underestimation of predicted Yield versus actual (Concentrator) Yield and so in some areas the Yields are upgraded (e.g. +15% in the A South Quarry areas) as discussed further in Section 3.4.6.

3.4.4 Historic Production and Expenditures

Table 13 shows historic production and cash costs over the last 3 years.

Table 13 Historic production and costs for the last three years (C1 as US\$/t product)

Item	Units	FY12	FY13	FY14
Concentrator Product Tonnes	Tonnes	4,306,259	5,027,138	4,776,976
Stripping Costs	U\$/t	12.54	13.48	16.08
Mining Costs	U\$/t	23.52	23.10	14.96
Production Costs	U\$/t	25.38	21.60	22.24
Haulage Costs	U\$/t	5.23	5.16	4.11
Other (Stock Movement)	U\$/t	0.02	-2.45	-0.98
Total C1 Costs		66.70	60.89	56.42

The mining cost unit rate dropped appreciably in FY14 due to several factors: more mining was done in quarries closer the Concentrator; less drill and blast was required in FY14 due to mining shallower ore; and the mining fleet was transitioning from a contractor fleet into an owner operator fleet. All of these had a positive impact on lowering costs.

Production costs have been relatively steady with FY12 having a higher unit rate due to lower concentrator tonnes being produced.

Haulage costs are those costs associated with the road train haulage of Concentrator product to the Port. There was a substantial reduction in haulage costs for FY14, predominantly due to the road train fleet going from contractor to owner operator at the start of FY14. These cost reductions are expected to continue for the remainder of the LoA.

The "Other" costs are related to inventory stockpile levels. An increase in inventory levels over the course of the year leads to a negative unit rate. These costs are a negligible portion of the C1 cost structure (1.7%).

There are no "General and Administration costs" in Table 13 because they have been distributed amongst the stripping, mining, production and haulage costs.

The overall C1 costs have shown a steady reduction in unit rates from FY12 to FY14. This is due to several factors: the operating cost improvements flowing through from the GEEP2 project; the site focus moving from growth to steady state production; and the transitioning from a contractor fleet to owner operator. These are expected to continue so that unit costs should remain in line with what was achieved in FY14 over the LoA.

3.4.5 Reconciliations

There is a clear procedure setting out the definitions and reconciliation process. Overall prediction of the manganese product grade and Concentrator Yields has historically not been an issue because of the continuity of geology, mineralisation and ore types, and the opportunity to blend material

from a number of Quarries onto the Primary Crusher Stockpiles (PCS) and again to blend products from the Concentrator on stockpiles at the Port.

The recent rapid expansion of production (Section 3.3.6) has meant that a grade control model is now required to improve short-term model predictions. Grade control practices are now being adopted but results for the grade control model are not sufficient to define trends yet.

G Quarry material is not included in the reconciliation because it does not go over the weighbridge. It currently represents a relatively insignificant proportion of production, although this may increase significantly at the end of the mine life.

Reconciliation of actual mined ore to the Ore Reserves (usually referred to as F1) was provided to CSA Global for the 14 months ending August 2014 (Figure 14).

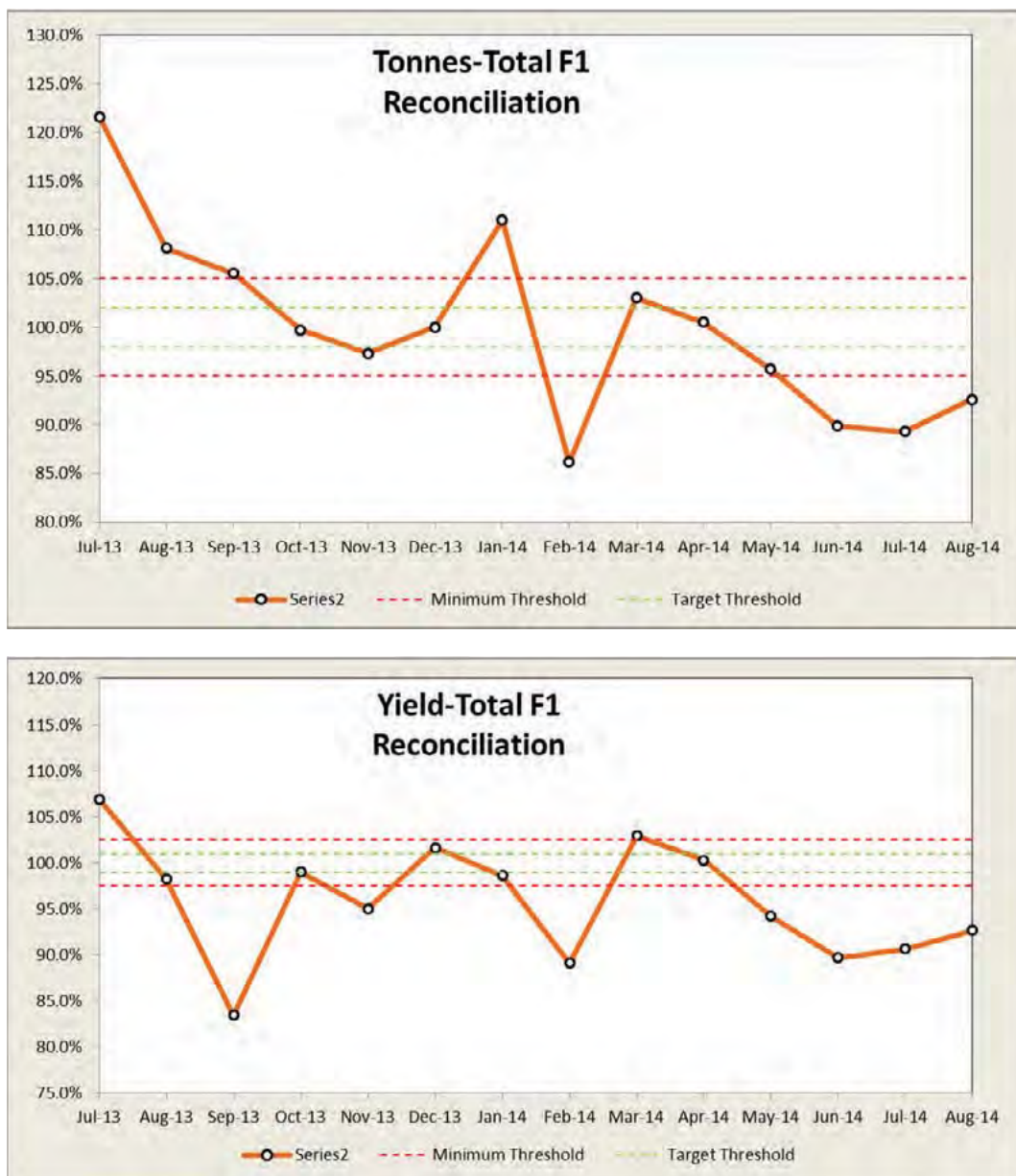

Figure 14 Reconciliation over a 14 month period of Actual Mined to the Ore Reserves for Total Tonnes and Yield

Source: GEMCO

Over this period the predictions are reasonable (as shown by the averages of the curves) with actuals being under by only 0.65% for Tonnes and under by 4.20% for Yield. While this is sufficient to assure the LoA Ore Reserves, on a monthly basis the Ore Reserves are not a reliable estimator of mined ore. It is accepted that the reconciliation process at GEMCO is complicated by the stockpiles of ROM ore (equivalent to about three months production) maintained at the PCS for blending of material types into the Concentrator and to guarantee crusher feed over the wet season.

3.4.6 Modifying Factors

There are a number of Modifying Factors used in the development of the FY14 LoA plan. These include:

- Density Adjustment – there is an *in situ* density Modifying Factor of 1.05 used to align the modelled plant feed with the actual plant feed. This factor is based on reconciliation data.
- Mining Recovery – there is a mining recovery of 0.95 applied to ore tonnes across all blocks in the Ore Reserves. This is equivalent to an ore loss of 5%. The reconciliation results in Table 14 show that this assumption is conservative.
- Mining Dilution – there is no mining dilution applied. While there may be some dilution in the mining process it is accepted that the visual control on the ore means most of it can be mined relatively cleanly and contaminants are removed by the Concentrator. Thus dilution is effectively dealt with by the Yield adjustment factor below.
- Yield Adjustment – an adjustment of 1.13 for Lump product and 1.19 for Fines product was applied to correct the 2014 Ore Reserve Yields. These adjustments are based on the last two years of reconciliation data. The adjustments are applied to the Lump and Fines Yields which are already present in the resource model. Table 15 indicates that the Yield adjustments are normally positive.
- ROM Moisture – the *in situ* and Run of Mine (ROM) moisture for tonnes fed to the Concentrator are both assumed to be 10% and this is used for mine planning. The actual moisture content can vary considerably between wet and dry seasons.

Table 14 Reconciliation of mining volume with resource model volume

Period	Survey volume A	Model volume B	Difference (A-B)/B
FY13Q1	871,968	1,078,483	-19%
FY13Q2	1,119,543	1,107,821	1%
FY13Q3	701,029	602,962	16%
FY13Q4	731,502	751,129	-3%
FY14Q1	997,760	957,021	4%
FY14Q2	827,276	830,817	0%
TOTAL	5,249,078	5,328,233	-1%

GEMCO currently reports the Ore Reserves as dry tonnes. This is expected to change in the future when an on-line moisture determination capability is introduced. This will assist with reconciliations and will not impact on Ore Reserve grades which are estimated and sold as dry metric tonne units (dmu).

Continual improvement and analysis of the Modifying Factors is ongoing. A mass balance project is currently underway that is expected to produce more accurate and consistent results and further improve confidence in the Ore Reserve Modifying Factors. None of the above Modifying Factors are of a magnitude that can materially impact on the Ore Reserve estimate developed by GEMCO.

Table 15 Historic Yield adjustment factors

Period	Lump Factor	Fines Factor
FY09	1.22	1.18
FY10	1.22	1.24
FY11	1.15	1.34
FY12	1.15	1.34
FY13	1.16	1.22
FY14	1.13	1.19

3.4.7 Mine Schedule and Validation

The Blasor optimisation process produces an optimal NPV solution as a spreadsheet defining the tonnes and grade by yearly 'buckets' which contain the various planned and numbered mining strips. These results are then used to define the long-term, medium-term and short-term planning. The consequence of this is that the Blasor output is used to report the Ore Reserve tonnes and grades and the mining schedule. However there is no 3D digital Ore Reserve model of blocks with tonnes and grades.

The Ore Reserves declared by GEMCO at 30 June 2014 were checked by CSA Global. The resource model provided by GEMCO (*grapr14.bmf*) was interrogated using a series of constraints followed by the application of the Modifying Factors (Section 3.4.6) that are used to convert the Mineral Resources to the Ore Reserves.

The constraints imposed on the resource model were as follows (model attributes are in **bold**):

- All blocks had to be fully inside the lease boundary **lease** to be included
- The ore thickness **class_thk** had to achieve a minimum of 1.0 m
- Only blocks were included that were not **mined** at 30 June 2014
- All blocks with **dom** are within the mining leases
- The Resource Category **rescat** was used for classification as Measured, Indicated or Inferred
- The stratigraphic layer **slayer** was used to define only MID and BOT mining horizons
- All mining blocks had to be within the provided pit design (Quarry strip) outlines provided by GEMCO.

The results from the above constraints are shown in Table 16 for dry tonnes. *Note that the tonnage estimates in Table 16 to Table 19 have not been rounded to reinforce that these are comparative calculations and not Ore Reserves.*

Table 16 GEMCO resource model constrained by specified model attributes

Mineral Resources	Tonnes (Dry)	Mn (%)	Yield (%)
Measured	81,300,727	45.8	48
Indicated	16,666,738	43.1	49

There is approximately 4.4 Mt (wet) of predominantly loose oolite from G Quarry that is to be mined in FY26 and FY27. In FY14 this was re-classified from Measured and Indicated down to Inferred (Table 17) and so was excluded from the Ore Reserves in FY14. This material is predominantly fine-grained sticky manganese with recovery problems during processing and handling problems during transport.

Table 17 G Quarry Resources downgraded to Inferred for Ore Reserve determination in FY14

Mineral Resources	Tonnes (Dry)	Mn (%)	Yield (%)
<i>Previously Measured</i>	4,362,383	37.6	90
<i>Previously Indicated</i>	16,105	31.2	90

These G Quarry tonnes, grades and Yields (Table 17) were subtracted from Table 16 and the ROM stocks (Table 18) were added to Table 16. Modifying Factors were then applied for density modification (+5%) mine recovery (-5%), Lump Yield (+13%) and Fines Yield (+19%) to give comparative factored Mineral Resources as shown in

Table 18 ROM Stocks for starting point adjustment

Mineral Resources	Tonnes (Dry)	Mn (%)	Yield (%)
Measured	1,994,204	31.3	55
Indicated	6,738	31.3	56

Table 19 Remaining Mineral Resources on mining leases with Modifying Factors applied

Mineral Resources	Tonnes (Dry)	Mn (%)	Yield (%)
Measured	78,740,202	46.0	54
Indicated	16,615,744	43.2	56

A comparison against the Ore Reserves declaration is provided in Table 20.

Table 20 GEMCO declared Ore Reserves at 30 June 2014 compared to CSA Global checks

JORC Code (2012) classification	GEMCO Ore Reserves			CSA Global check		
	Tonnes (Dry Mt)	Mn (%)	Yield (%)	Tonnes (Dry Mt)	Mn (%)	Yield (%)
Proved Ore Reserve	78.2	45.0	58	78.7	46.0	54
Probable Ore Reserve	16.0	42.6	57	16.6	43.2	56
Total Ore Reserve	94.3	44.6	58	95.4	45.5	54

The tonnage comparisons obtained by CSA Global from interrogating the Mineral Resource model are excellent overall but showed relative differences of up to 2% higher for grades and 7% lower for Yields. This is partially explained by allocation of small tonnages in the mining schedule to bypass the HMS part of the plant and to the large variations in Lump and Fines Yield factors for various ore types. This does indicate some uncertainty in the prediction of short-term production. Lump and Fines factors as high as 22.1% (FY10 Reserve) and Fines factors as high as 33.7% (FY12 LoA plan) have been used recently in planning.

Overall, the differences in Yield prediction are not considered material, based on the long history of mining ore from all current Quarries.

The Mineral Resource and Ore Reserve estimates for GEMCO's manganese mine at Groote Eylandt have been examined and validated by CSA Global under the JORC Code (2012). The Ore Reserves declared by GEMCO are accepted by CSA Global as a reasonable basis for depletion to 31 December 2014. The accepted Proved Ore Reserve was depleted, using production up to 31 October 2014 and forecast production to 31 December 2014, by a total of 4.56 Mt at 47.2% Mn. The Ore Reserves as depleted by CSA Global are provided in Table 21.

Table 21 GEMCO Ore Reserves at 31 December 2014 after depletion of production since 30 June 2014

JORC Code (2012) classification	GEMCO Ore Reserves		
	Tonnes (Dry Mt)	Mn (%)	Yield (%)
Proved Ore Reserve	73.7	44.9	58
Probable Ore Reserve	16.0	42.6	57
Total Ore Reserve	89.7	44.5	58

3.4.8 Risks and opportunities

G Quarry contains predominantly loose oolite (composed of ooliths, less than 2 mm diameter) and wad (amorphous, cryptocrystalline powdery MnO₂) high grade manganese ore that is poorly consolidated. Handling this material is problematic as it is sticky to mine and processing produces low Yields with loss of metal units to tailings. Currently the maximum planned mining of this material is 0.22 Mtpa which is not fed to the Concentrator but sold as direct shipping product. In

the final two years of mine life the LoA schedule allows for 4.4 Mt from G Quarry, but this is not included in the Ore Reserve estimate.

The following low-level risks to the mining plan have been identified and are not considered material to the Ore Reserves:

- The GEMCO operation is in a high rainfall zone (Section 2.4). Mine planning is geared towards preferentially mining some material in the dry season and stockpiling it at the Primary Crusher Stockpiles (PCS). Disruption to the operation by cyclone alerts can occur during the wet season, generally only for up to three days.
- A Shiploader failure would prevent product sales and would be a catastrophic event until remedied.
- Disruption of the Rowell Highway, the sealed road transport route used by road trains, would prevent product being moved to the Milner Bay Port for shipping.
- Rupture of any of the TSFs or process water dams would impact local vegetation.
- Withdrawal of approval to mine by the Government, Aboriginal Land Councils or local Traditional Owners would disrupt mining.

Opportunities exist to extend the Ore Reserves and consequently the mine life by:

- Converting the Mineral Resources for the Sand Tailings (Section 3.2.6) to Ore Reserves (capital expenditure approval and other requirements are in place or imminent; expected grades and Yields are yet to be defined).
- Creating a suitable GEMCO product for material with grades between 35% and 40% Mn that can be marketed and shipped to an agreed specification.
- Demonstrating the successful recovery and handling of the G Quarry material excluded from the Ore Reserves (the predominantly loose oolite may be blended, or bagged and direct shipped as chemical fines, etc.).
- Successfully defining an Ore Reserve in the Eastern Leases (requiring granting of all necessary approvals, further drilling, construction of haul roads, etc.).
- Successfully defining an Ore Reserve in the Southern Area (requiring successful exploration, internal capital expenditure authorisation, all necessary approvals, granting of Mining Leases, further drilling, feasibility study, etc.).
- Successful exploration of the adjacent islands and NT mainland (requiring successful exploration to define a Mineral Resource and other requirements as above).

4 Valuation of Ore Reserves

4.1 Valuation Methodology

The Code for the Technical Assessment and Valuation of Mineral and Petroleum Assets and Securities for Independent Experts Reports (VALMIN) sets out guidelines for the valuation of mineral properties. The VALMIN Code (2005) classifies mineral assets into categories which represent a spectrum from Exploration Areas where mineralisation may or may not have been identified through to Operating Mines (mineral properties, particularly mines and processing plants that have been commissioned and are in production). Under the current ASX listing rules, Operating Mines of public companies are expected to have an Ore Reserve reported under the JORC Code (2012).

Different valuation methodologies may be applied but regardless of the technique employed, consideration must be given to the perceived 'fair market valuation'. This is described in the VALMIN Code under Definition 43:

"Value is the Fair Market Value of a Mineral or Petroleum Asset or Security. It is the amount of money (or the cash equivalent of some other consideration) determined by the Expert in accordance with the provisions of the VALMIN Code for which the Mineral or Petroleum Asset or Security should change hands on the Valuation Date in an open and unrestricted market between a willing buyer and a willing seller in an 'arm's length' transaction, with each party acting knowledgeably, prudently and without compulsion."

CSA Global was commissioned to provide an independent Valuation of the Ore Reserves of GEMCO, to fulfil the requirements of the ESMA Recommendations.

The Groote Eylandt manganese mine has been in continuous operation since the 1960s and has been the subject of extensive Mineral Resource definition drilling and mine production. There are well-established Ore Reserves and a robust LoA plan. These have been assessed in detail to verify the technical soundness and economic viability of future mining operations. For Valuation, the use of differing methodologies has been considered and the discounted future cash flow (DCF) method has been selected as the most appropriate for valuing the GEMCO Asset.

4.2 Manganese Market and Outlook

The Groote Eylandt manganese product is exported from the Milner Bay Port facility to the international ferro-alloy market.

Approximately 80 per cent of ore production is sold directly to external customers, predominantly located in China, South Korea and India, and the remainder is used as feedstock in the BHP Billiton TEMCO alloy smelters. Manganese ore is sold on short-term or spot contracts, with prices linked to published indices. The commodity is not exchange traded, and prices are largely determined by supply and demand balances. Ore is priced per dry metric tonne unit (dmtu) and referenced to a benchmark ore of 44% Mn cost insurance freight (CIF).

Historically, manganese ore has traded at levels around US\$2.00/dmtu with little price volatility, until rising in 2005 with further significant price rises in 2007, before reaching a monthly peak of US\$18.40/dmtu in 2008 for medium grade Lump ore CIF China.

With a tightening in the global market balance due to a combination of rapid growth in global demand for manganese against a backdrop of tight supply, global demand reached new records as smelting facilities worldwide ramped up output to new highs and China's demand for imports rose significantly. This resulted in pressure on the supply chain, which was already at full capacity.

As a result of the global financial crisis, earlier gains in manganese ore prices were eroded and prices fell to a floor of around US\$3.50/dmtu in May 2009. A swift return of Chinese import demand and a gradual recovery in alloy production around the world underpinned a recovery in prices in late 2009 to 2010. Since then, prices have tracked a declining, or at times steady, path. Most recently (2014 H1) manganese ore prices have fallen sharply from \$5.70/dmtu to \$4.35/dmtu (Table 22).

Table 22 Annual average manganese prices for the 44% SL Mn benchmark

		2007	2008	2009	2010	2011	2012	2013	2014
Annual average price 44% Mn Lump, CIF China	US\$/dmtu	5.67	14.38	5.32	7.33	5.46	4.93	5.43	4.59

4.3 Cash Flow Modelling and Assumptions

4.3.1 CSA Global Approach

GEMCO has developed a comprehensive and detailed cash flow model based on their declared Ore Reserves at 30 June 2014. CSA Global has conducted checks and analysis of these models and found them to be a reasonable basis for Valuation of the Asset for the purposes of this report. The integrity of the cash flow models was checked as follows:

- Review of model detail, underlying assumptions and outputs with the model developers at GEMCO Brisbane.
- Review of the BHP Billiton model change log sheets over a 12 month period and NPV change documentation which was reconciled to the GEMCO FY15 LoA plan documentation and reporting.
- Independent review by CSA Global of model underlying assumptions, key drivers and outputs.
- External modelling by CSA Global of the key drivers and inputs demonstrating agreement between the model provided and this external model within $\pm 5\%$.

CSA Global has used the base of GEMCO's FY15 LoA plan and strategic cash flow model to develop a Valuation model for the Groote Eylandt mining operation and to assess the sensitivity of the project value to changes in key assumptions. CSA Global is satisfied with the integrity and operational assumptions contained within these models and has undertaken an external assurance process to ensure that the model is suitable for use in this report.

Key assumptions relating to manganese ore pricing, foreign exchange rates, and discount rates were independently determined by CSA Global and the ungeared post-tax real cash flows as at a valuation date of 31 December 2014 were discounted to derive a range of present values.

Key assumptions adopted by CSA Global in deriving a Base Case value for the GEMCO Asset are provided in Table 23.

Table 23 Key assumptions in deriving a Base Case value for the GEMCO Asset

Inputs	Amount	Unit	Source
Corporate Tax Rate	30	%	Australian corporate tax rate
Real Discount Rate	7.0 to 8.0	%	Weighted average cost of capital (WACC) - CSA
Long Term Mn Ore 44% SL Mn Benchmark CIF China	5.49	US\$/dmtu	CRU International October 2014 Mn Ore Market Outlook
Long Term Foreign Exchange Rate	0.83	A\$/US\$	Current November 2014 rate and Australian / US Economic Outlook
Capital Cost	960	US\$ M	GEMCO
Total Closure Cost	390	US\$ M	GEMCO (see Section 2.6.6)
Plant Capacity	9.5	Mtpa	GEMCO
Life of Mine Mn Ore Sales	50.9	Mt	Valuation Date 31 st December 2014 to end FY27

4.3.2 Commodity Pricing Assumptions

Assumptions regarding commodity pricing were made having regard to the manganese ore and manganese alloy market outlook to 2018 as well as historical pricing trends. Current analysis of the manganese alloy sector indicates that margins and profitability of alloy producers is likely to remain steady over the period 2015 to 2018 due to market balances (CRU, 2014).

The short term outlook for manganese ore in 2015 H1 is for a continuing period of product oversupply with stocks at major Chinese ports remaining high. This will continue to provide pressure on manganese ore prices in the short term.

The medium term outlook through 2016 and 2017 for the manganese ore market is for supply and demand to be mainly balanced, with increased import demand from China. This increased import demand is expected to result from reduced Chinese domestic production of manganese ore on the back of declining ore grades and rising costs due to more difficult mining conditions at their operations. This assumption is central to forecasts of prices rising, but not far from current levels, based upon the volume of Chinese manganese ore required in the market.

It is anticipated that where possible, China will import higher quality and potentially lower cost manganese ore from abroad, leading to a rising dependency on imports in the years ahead, with marginal Chinese production underpinning rising prices through to 2018.

Following a review of commodity research data from CRU International Limited, publicly available information, and market conditions described above, CSA Global has derived manganese ore prices of US\$4.59/dmtu for the remainder of FY15, rising to US\$4.90/dmtu in FY16, US\$5.09/dmtu in FY17, and a long term price of US\$5.49/dmtu thereafter (Figure 15).

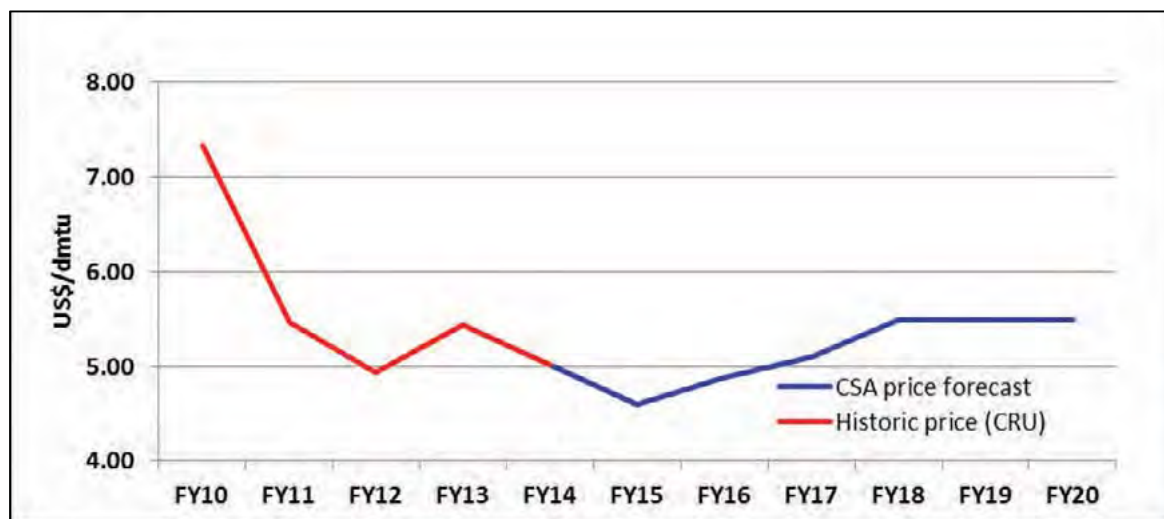

Figure 15 CSA Global forecast of Mn prices

4.3.3 Exchange Rate Assumptions

The Australian Dollar to US Dollar (A\$/US\$) exchange rate forecast has been derived using the 40 day average as at 19 November 2014 (0.8751) and the outlook for the strength of the US dollar following the 29 October 2014 announcement by the US Federal Reserve regarding the conclusion of its bond-buying program (quantitative easing). Current expectations by financial markets are for the US Federal Reserve to commence interest rate rises before the end of 2015.

The Reserve Bank of Australia (RBA) is not expected to cut the cash rate again in this cycle with the next movement forecast to involve a rate rise by mid-2015. Business investment in Australia has continued to fall from its late 2012 peak, with some positive movements in non-mining investment. It is anticipated that by the middle of 2015, the RBA will return to a monetary policy involving a rise in the official cash rate.

The Australian dollar is also influenced by the outlook for commodity prices due to Australia's role as a large commodity exporter. There is a mixed outlook for commodity prices, largely reflecting shifting demand dynamics within China. The outlook for Australia's large exports of coal and iron ore is one of further downward pressure on prices. Commodity prices heavily influence Australia's export prices and terms of trade (the ratio of export prices to import prices). This has fallen in three of the last four quarters and is likely to keep declining. The decline represents a net transfer of income from Australia to the rest of the world, thus weighing down the A\$. The terms of trade is a strong influence on the Australian currency over the medium to long term, so the A\$ will be weaker.

The A\$/US\$ exchange rate adopted as at 19 November 2014 was 0.88. CSA Global has determined that, given the factors outlined above, an exchange rate of 0.88 for the remainder of FY15 is appropriate. Thereafter, CSA Global has forecast a reduction of 0.01 year on year until FY20, and a long term exchange rate of 0.83 from FY21 (Figure 16).

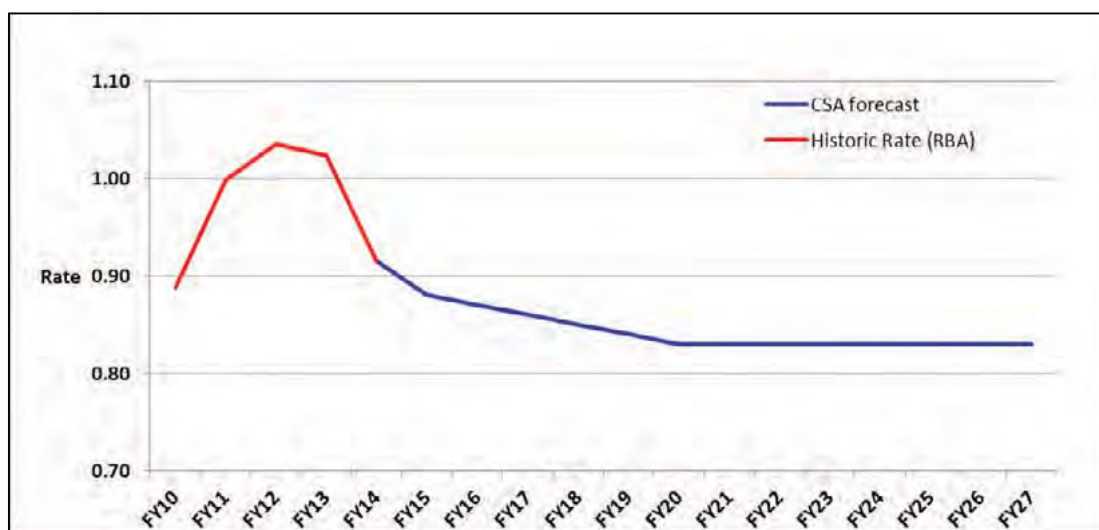

Figure 16 Historic and forecast A\$/US\$ exchange rates

4.3.4 Discount Rate Determination

The rate used to discount future cash flows to determine the NPV for valuation should represent the required market rate of return for capital invested in the project being valued.

The expected rate of return for invested capital is generally determined using the weighted average cost of capital (WACC) approach using market evidence from comparable sector companies. It is derived on a post-tax real basis.

In calculating a WACC for the GEMCO investments of BHP Billiton, CSA Global used the following inputs, since BHP Billiton's primary listing is on the ASX:

- Risk free rate of 3.3% being the Australian Government 10 year bond yield
- Market risk premium of 8.1% from the Independent Pricing and Regulatory Tribunal (IPART) August 2014 WACC update
- Debt Margin of 2.2% from IPART
- Australian inflation rate of 2.3% from the Reserve Bank of Australia (RBA)
- BHP Billiton Debt to Equity ratio of 0.41 from BHP Billiton 2014 Annual Report 2014
- BHP Billiton equity beta of 1.21 from BHP Billiton November 2014 share price

These inputs derive a post-tax real WACC of 7.5% which CSA Global has adopted as a base case discount rate. In order to model the sensitivities of the NPV to changes in discount rate, the NPV was also modelled at 7.0% and 8.0%.

4.3.5 Ore Production Physicals

The Valuation Date as at 31 December 2014 was modelled by summing the July 2014 to October 2014 actual ore production plus the planned November to December production and depleting the FY15 ore schedule by this amount.

Only Ore Reserves were used for the cash flow modelling. The July 2014 Portfolio Valuation Review (PVR) and FY15 LoA cash flow models currently used by GEMCO include Inferred Mineral Resources. These amount to 21.3 Mt which is 22% of the overall tonnes in the LoA plan.

Under the JORC Code (2012) Inferred Mineral Resources cannot be part of the Ore Reserves. These Inferred Mineral Resources were excluded from the ore production schedule for the purposes of CSA Global's Valuation of Ore Reserves. Some of this material is the production expected from G Quarry at the end of the mine life (see Section 0).

The current production schedule is detailed in Figure 17 with G Quarry and other Inferred Mineral Resources removed.

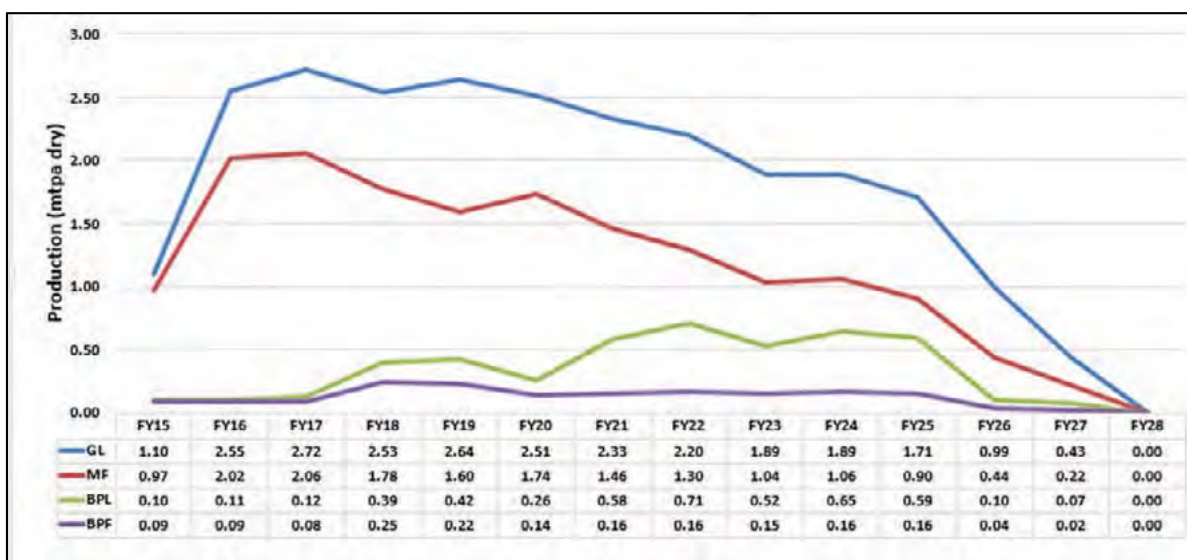

Figure 17 GEMCO ore production summary in the FY15 LoA plan after removal of Inferred Mineral Resource

4.3.6 Operating Costs

Operating costs were derived based upon the assumptions contained in the PVR (Figure 18). It can be seen from Figure 19 that the total operating cost of manganese produced rises from a low of US\$1.40/dmtu in FY18 to over US\$2.00/dmtu from FY23 onwards. This is related to the reduction in ore tonnes produced following exclusion of the Inferred Mineral Resources from the production schedule used for the purposes of this Valuation. The spike in unit operating costs in FY26 and FY27 is a result of the significant proportion of Inferred Mineral Resources excluded, being 72% and 82% of the mined ore in the last two years of the LoA plan. As resource definition drilling and mine planning studies continue these Inferred Mineral Resources are expected to become at least Indicated Resources and be included in the Ore Reserves.

The current GEMCO provision for mine closure costs is US\$ 390 million (Section 2.6.6), which was increased as part of the FY16 LoA plan completed in October 2014 and is primarily for tailings dam rehabilitation and the expected extension of the mine life.

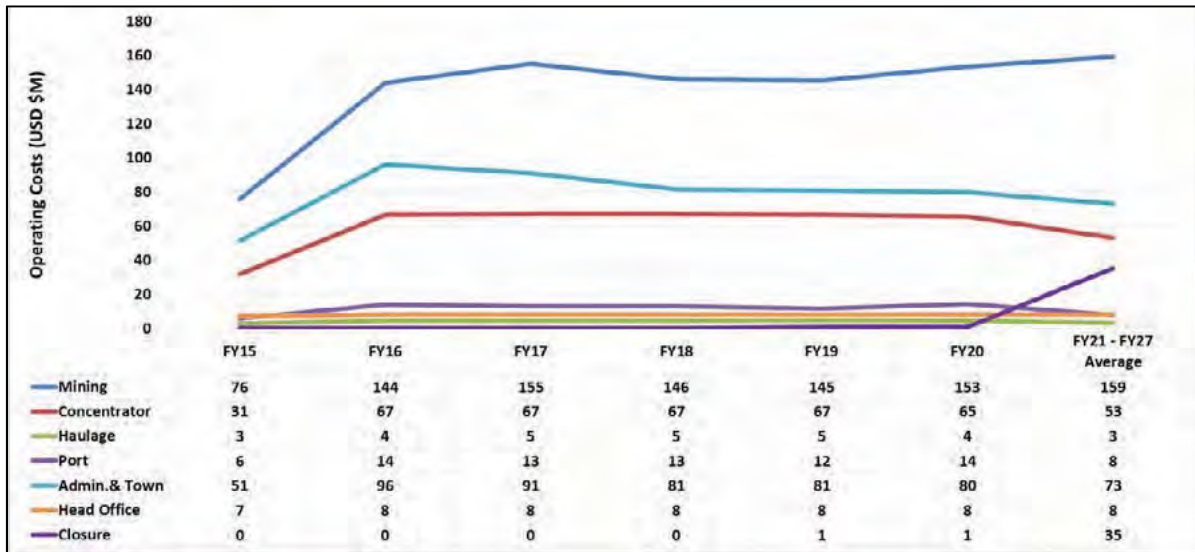

Figure 18 GEMCO operating costs in US\$

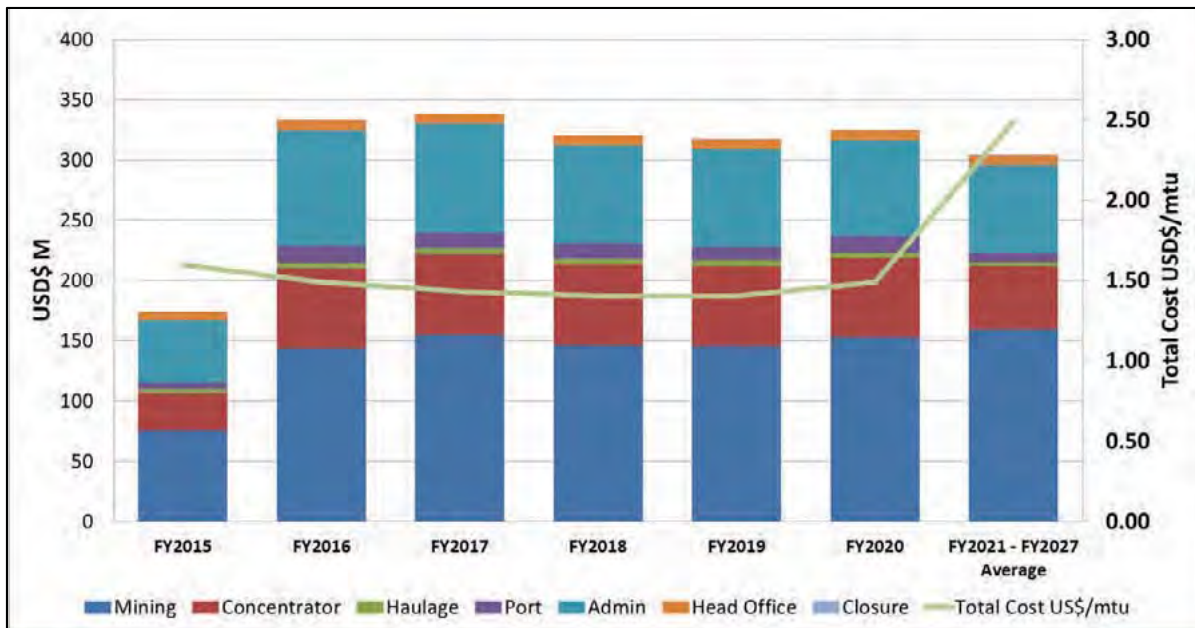

Figure 19 GEMCO cash costs in US\$

4.3.7 Capital Costs

Capital costs relating to ore production were amended to reflect the exclusion of Inferred Mineral Resources from the production schedule. Modified capital costs of US\$960M are primarily related to sustaining capital of US\$463M, tailings dam construction of US\$161M, earth moving equipment (EME) replacements of US\$123M, and pit opening capital of US\$55M (Figure 20).

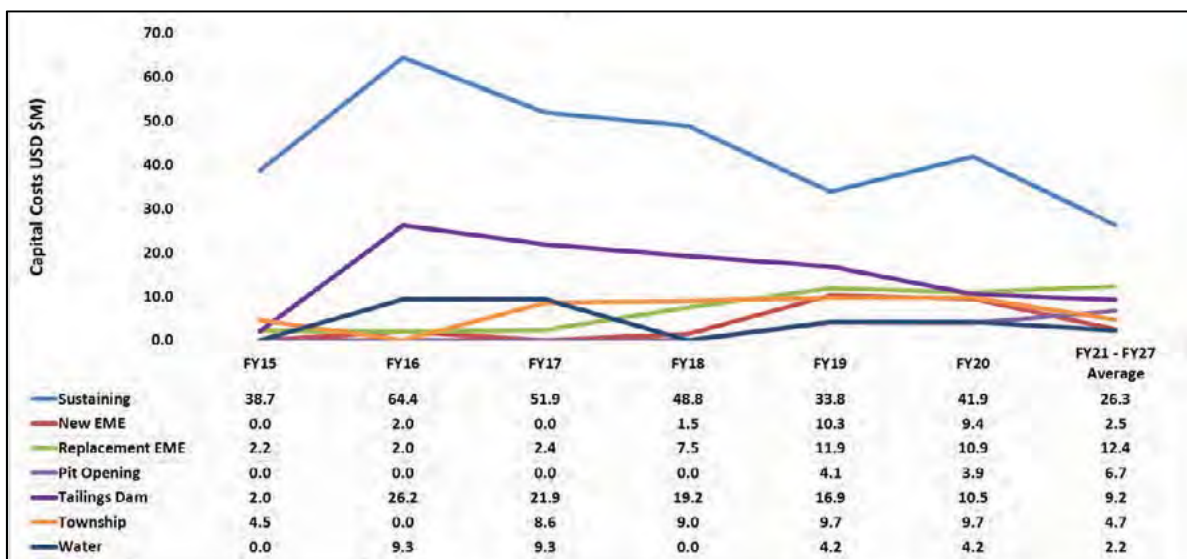

Figure 20 GEMCO capital costs

4.4 Undiscounted Cash Flows – Base Case

The profile of undiscounted cash flows over the current Life of Asset is provided in Figure 21.

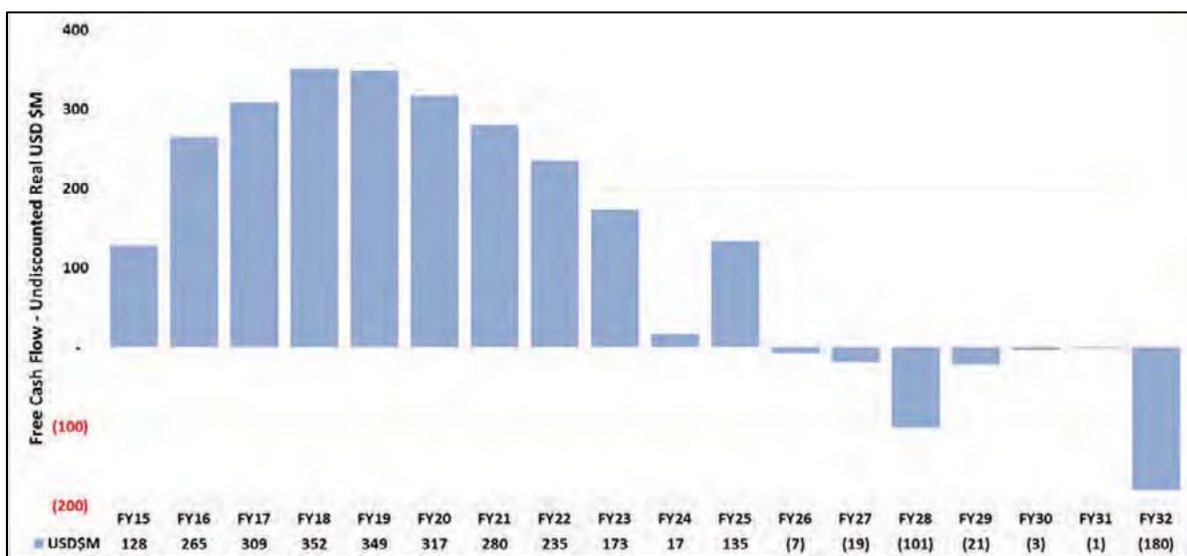

Figure 21 GEMCO undiscounted cash flows – Base Case

4.5 NPV Valuation – Base Case

Using the key input assumptions described above as the Base Case, CSA Global has derived an ungeared, after-tax NPV of US\$1,721 million for 100% of the GEMCO Ore Reserves over the remaining mine life of 12.5 years from 31 Dec 2014 through 30 June 2027, the end of FY27 (Table 24).

Table 24 Base case value for GEMCO Asset over the Life Of Mine to end of FY27

Item	Units	Amount
PHYSICALS		
Ore Reserve tonnes (dry)	Mt	89.7
Ore Reserve grade (recovered)	% Mn	44.5
Ore Reserve Yield	%	59.4
Total product tonnes (dry)	Mt	54
Total mine operating costs	US\$ M	4,392
Total unit operating costs	US\$ /mtu	1.93
Capital costs	US\$ M	960
Closure costs	US\$ M	390
Mine life	years	12.5
Discount rate	%	7.5
NPV	US\$ M	1,721

4.6 NPV Valuation – Range Analysis

Keeping the quantitative physicals (tonnes, grades and costs) the same, the Base Case assumptions were varied to reflect the economic performance of the project under lower and higher commodity prices and exchange rates.

The long term benchmark Mn ore price was varied from the base case by $\pm 10\%$, as was the A\$/US\$ exchange rate. When combined with discount factors derived from the after-tax real WACC of between 7.0% and 8.0%, a value range for 100% of the project was determined. The Base Case and Range NPVs are presented in Table 25, also showing the 60% share of GEMCO that is owned by BHP Billiton.

Table 25 Range analysis of the GEMCO Asset value over the Life Of Mine to end of FY27

Input Parameter	Units	Lower	Base	Upper
Long Term ore price 44% SL Mn Benchmark CIF China	US\$/dmtu	4.94	5.49	6.04
Long Term Exchange Rate	A\$/US\$	0.91	0.83	0.75
Real Discount Rate (WACC)	%	8.0	7.5	7.0
After-tax NPV	US\$ M	1,133	1,721	2,337
BHP Billiton share (60%)	US\$ M	680	1,033	1,402

4.7 Sensitivity Analysis

Tornado diagrams are used for deterministic sensitivity analysis to show the relative importance of input variables. Each of these are modelled separately while all other variables are held at the Base Case values. For the input parameters in Table 25, optimistic and pessimistic values were selected to describe the reasonable sensitivity range over which these inputs might vary.

From the tornado diagram Figure 22 it can be seen that the project is most sensitive to changes in the commodity price and the foreign exchange rate.



Figure 22 Tornado diagram showing sensitivities of Base Case to key drivers (US\$ M)

Since the most impact on variance is due to the Mn price, a number of two variable sensitivity analyses were performed, whereby each of the other inputs was varied with Mn price, holding all other inputs at their Base Case values. These are presented in Figure 23 to Figure 28 in order of their impact as shown in the tornado diagram (Figure 22). Each of these shows the impacts on NPV over the variation range with the Base Case NPV in blue, the lowest in red and the highest in green.

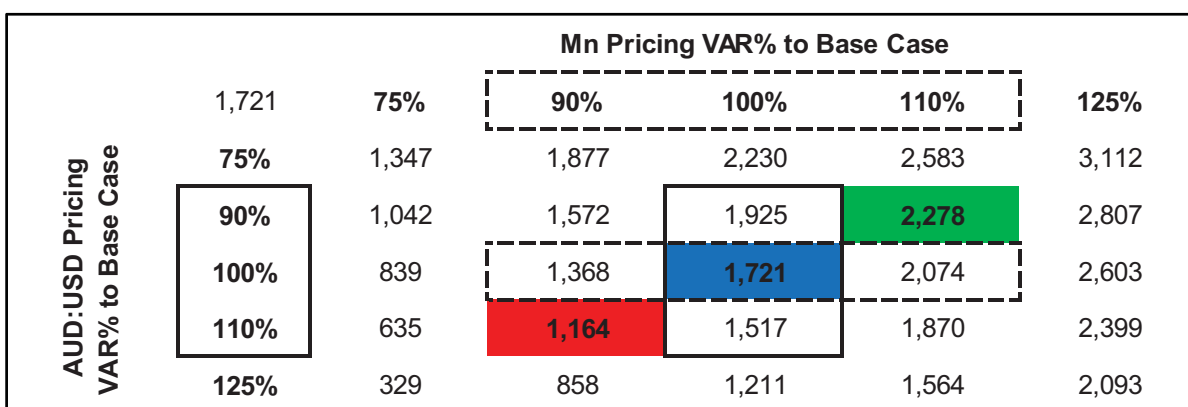

Figure 23 Exchange rate and Mn price variance to Base Case

		Mn Pricing VAR% to Base Case					
			90%	100%	110%	125%	
Product Sales VAR% to Base Case	1,721	75%					
	95%	721	1,227	1,564	1,901	2,406	
	98%	780	1,298	1,642	1,987	2,505	
	100%	839	1,368	1,721	2,074	2,603	
	103%	897	1,438	1,799	2,160	2,701	
	105%	955	1,508	1,876	2,245	2,798	

Figure 24 Product sales and Mn price variance to Base Case

		Mn Pricing VAR% to Base Case					
			90%	100%	110%	125%	
Operating Costs VAR% to Base Case	1,721	75%					
	90%	1,109	1,638	1,991	2,344	2,873	
	98%	906	1,436	1,788	2,141	2,671	
	100%	839	1,368	1,721	2,074	2,603	
	103%	771	1,300	1,653	2,006	2,536	
	110%	568	1,098	1,451	1,804	2,333	

Figure 25 Operating costs and Mn price variance to Base Case

		Mn Pricing VAR% to Base Case					
			90%	100%	110%	125%	
Capital Costs VAR% to Base Case	1,721	75%					
	90%	904	1,433	1,786	2,139	2,668	
	95%	871	1,401	1,753	2,106	2,636	
	100%	839	1,368	1,721	2,074	2,603	
	105%	806	1,335	1,688	2,041	2,571	
	110%	774	1,303	1,656	2,009	2,538	

Figure 26 Capital costs and Mn price variance to Base Case

		Mn Pricing VAR% to Base Case				
		75%	90%	100%	110%	125%
Product Grades VAR% to Base Case	1,721	75%	1,289	1,633	1,977	2,493
	98%	772	1,336	1,686	2,035	2,559
	99%	812	1,368	1,721	2,074	2,603
	100%	839	1,400	1,756	2,113	2,647
	101%	865	1,447	1,809	2,171	2,714
	103%	905				

Figure 27 Product grades and Mn price variance to Base Case

		Mn Pricing VAR% to Base Case				
		75%	90%	100%	110%	125%
Discount Rate VAR% to Base Case	1,721	75%	1,476	1,873	2,270	2,866
	5%	880	1,389	1,750	2,111	2,653
	7%	847	1,368	1,721	2,074	2,603
	8%	839	1,347	1,692	2,037	2,555
	8%	830	1,266	1,582	1,898	2,372
	10%	792				

Figure 28 Discount rate and Mn price variance to Base Case

4.8 Project Opportunities

Several opportunities exist which have been the subject of detailed planning by GEMCO, and are currently in the process of development or are planned. These include:

Production Profile

The Life of Asset planning for GEMCO is based on Mineral Resources including those in the Inferred category; these are not included in this Valuation of Ore Reserves. The GEMCO Asset has been in continuous operation for over fifty years and the controls and distribution of manganese mineralisation are well understood.

It is likely that with further drilling and planning studies, some Inferred Mineral Resources will be upgraded to a higher confidence category and become part of the Ore Reserves. The FY15 LoA plan includes 21.3 Mt of material in this category that may add to the mine life and make a significant contribution to the NPV.

Product Grade

GEMCO has historically shipped product at a higher grade than that forecast by the mining operations. This 'buffer' is to ensure that a shipment does not get delivered below specification which would result in penalties. Shipment grades above specification positively impact on the

relativity of the sale price to the benchmark price. Although not quantified for this Valuation of Ore Reserves, it would have a positive impact on the NPV of the Asset.

Premium Concentrate (PC02) Project

The FY14 Mineral Resources include Sand Tailings (Section 3.2.6). A study has been completed demonstrating the economic potential of reprocessing this material. The Premium Concentrate Project (PC02) was approved for development in August 2014 at a capital cost of US\$139 million, and as at November 2014 is in the early stage of execution, although yet to commence construction activities. PC02 is expected to be complete by the end of FY16 and ramp-up to full production of 0.5 Mtpa in FY17, increasing sales capacity from 4.8 Mtpa to 5.3 Mtpa. This will take place through the introduction of a stand-alone processing facility near the existing concentrator to produce a premium concentrate product for export sale. The expansion also involves an update to port infrastructure to handle the blending of premium concentrate with existing Fines products.

Since the Sand Tailings are not included in the Ore Reserves, PC02 is not included in this Valuation however it can be expected to have a positive impact on the NPV of the GEMCO Asset.

4.9 Valuation Summary

CSA Global has determined a Valuation for the GEMCO Asset of BHP Billiton based upon the stated Ore Reserves at 31 December 2014. A range of sensitivities relating to commodity price, the A\$/US\$ exchange rate and discount rate were undertaken on the cash flow model. CSA Global considers the ranges selected are representative of a range of reasonable outcomes for these key assumptions over the life of the Asset. The Base Case Value determined by CSA Global for BHP Billiton's 60% share of the GEMCO Asset is US\$1,033 million. GEMCO's Groote Eylandt Mine has an expected mine life of 12.5 years to the end of FY27, i.e. 30 June 2027.

CSA Global considers that current and planned opportunities will realise additional value above that presented as the Base Case Valuation of the Ore Reserves. In terms of the VALMIN Code, the Base Case NPV is a Technical Value derived from a static cash flow model, rather than a Market Value, which in CSA Global's opinion is likely to be above the Base Case.

Taking into consideration the opportunities to realise value above that represented by the Base Case, CSA Global considers the Preferred Value lies between the Base Case and the upper limit of the range of sensitivity studies.

The Market or Fair Value for 100% of the GEMCO Asset based on the Ore Reserves is expected to lie in the range from US\$1.7B to US\$2.3B, with a most likely value of US\$2.0B. BHP Billiton's 60% share is valued in the range from US\$1.0B to US\$1.4B with a most likely value of US\$1.2B.

This valuation is reflective of GEMCO's mining operations at Groote Eylandt, based on CSA Global's view in relation to manganese Ore Reserves only. It is important to emphasise that this value does not represent the value of the Ore Reserves in the ground in isolation, but incorporates the value of all ungeared net assets contributing to the project based on the Ore Reserve production profile. At GEMCO this includes the value of the mining equipment fleet, Concentrator, Milner Bay Port and all other supporting infrastructure as well as the mine, over the projected Life of Asset.

5 References

BHP Billiton, 2013. Manganese Australia FY15 LoA. Unpublished BHP Billiton report, October.

BHP Billiton, 2014. BHP Billiton Annual Report available on www.bhpbilliton.com.

CRU, 2014. Mn Ore Market Outlook, October, CRU International.

Ferenczi, P., 2001. Iron ore, manganese and bauxite deposits of the Northern Territory. Northern Territory Geological Survey, Report 13, 113 pp.

Frakes L. A. and Bolton, B. R., 1984. Origin of manganese giants: Sea-level change and anoxic-oxic history: *Geology*, v. 12, p. 83-86.

Hope, D. and Bryant, M., 2014. Competent Persons Report for GEMCO including Mineral Resources and Ore Reserves as at 30 June 2014. Unpublished BHP Billiton report, June (CP FY14).

Hope, D., 2014. Competent Persons Report for GEMCO Sand Tailings including Mineral Resources as at 30 June 2014. Unpublished BHP Billiton report, June.

JORC Code, 2012. Australasian Code for Reporting of Exploration Results, Mineral Resources and Ore Reserves. Prepared by the Joint Ore Reserves Committee of the Australasian Institute of Mining and Metallurgy, Australian Institute of Geoscientists and Minerals Council of Australia (JORC).

Ostwald, J., 1988. Mineralogy of the Groote Eylandt manganese oxides: A review: *Ore Geology Rev.*, v. 4, p. 3-45.

Pracejus, B. and Bolton, B. R., 1992. Geochemistry of supergene manganese oxide deposits., Groote Eylandt, Australia: *Economic Geology*, v. 87, p. 1310-1335.

VALMIN Code, 2005. Code for the Technical Assessment and Valuation of Mineral and Petroleum Assets and Securities for Independent Expert Reports. VALMIN Committee, a joint committee of AusIMM, AIG and MICA.

This page has been intentionally left blank.

ANNEXURE 6

INDEPENDENT COMPETENT PERSONS' REPORTS

5. Hotazel Manganese Mines – CSA Global
-

This page has been intentionally left blank.



Date: 5 March 2015
Report No: R289.2014

Competent Person Report

BHP BILLITON - HOTAZEL

Hotazel Manganese Mines

South Africa

by

Dr Bill Shaw

FAusIMM, CPGeo, FAIG, RPGeo

Paddy Reidy

MAusIMM

Valuation effective date: 31 December 2014

For:

BHP Billiton and South32 Limited
171 Collins Street
Melbourne VIC 3000
Australia

Approved:

Electronic signature not for duplication. Electronic signature not for duplication. Electronic signature not for duplication. Electronic signature not for duplication. Electronic signature not for duplication. Electronic signature not for duplication. Electronic signature not for duplication. Electronic signature not for duplication. Electronic signature not for duplication. Electronic signature not for duplication.

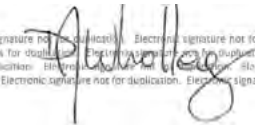
D Wholley, Director



Executive Summary

Introduction

This Competent Person Report (CPR) was prepared for BHP Billiton and South32 Limited by CSA Global Pty Ltd (CSA Global), between October and December 2014, on the Ore Reserves of Hotazel Manganese Mines (Pty) Ltd (referred to in this report as Hotazel). Hotazel consists of two operating mines (the open pit Mamatwan Mine and the underground Wessels Mine) and two non-operating mines (the underground Middelpplaats Mine and the open pit and underground Old Hotazel York Mine). Under instruction from BHP Billiton, CSA Global has not undertaken any assessment of these two operations, nor of the Metalloys smelter in Johannesburg, and these are not included in the Valuation of Hotazel.

BHP Billiton manages the Hotazel operations and holds a 44.4% interest, with Anglo American holding 29.6% and a group of Broad-Based Black Economic Empowerment companies holding the remaining 26%.

CSA Global makes the following findings for the manganese Ore Reserves at the Mamatwan and Wessels Mines in Northern Cape Province of South Africa.

There are no material flaws in the technical aspects examined by CSA Global and documented in this CPR. Appropriate technical information was provided for review and it was considered to be reasonable and sufficient.

Social Licence to Mine

Appropriate risk management procedures are in place to deal with environmental issues, including all aspects of the social licence to mine, although these can never be assured. There are no apparent issues that could materially impede production. CSA Global is advised that there are no material prosecutions pending and that all required tenements are in good standing.

Mineral Resources

BHP Billiton has prepared and documented their Mineral Resources and Ore Reserves at 30 June 2014 using appropriate methodologies in Ferreira *et al* (2014a, 2014b) collectively referred to as CP FY14, with Ore Reserves based on mine planning documented in BHP Billiton (2013) and referred to as the FY14 Life of Asset (LoA) plan.

Hotazel has an appropriate level of geological understanding to support the mine planning process at both Mines. Geotechnical understanding is appropriate for management of the Mamatwan Mine. At Wessels an issue was identified with the application of geotechnical constraints to mining. Checks by CSA Global indicate that this should not impact the long-term Ore Reserves and Valuation provided by CSA Global but further detailed mine planning work is required.

CSA Global has determined the depleted Mineral Resource for Mamatwan at 31 December 2014 by deducting actual production to 30 September and forecast production to 31 December 2014 to be as provided below. This is at a cut-off grade of 35% Mn, is inclusive of

Ore Reserves, and includes material defined in the Top Cut that may not become Ore Reserves.

Mamatwan Mineral Resources depleted to 31 December, 2014

Mineral Resource	Tonnes (Wet Mt)	Mn (%)	Fe (%)
Measured	28.5	35.5	5.1
Indicated	69.6	35.1	5.0
Total Measured + Indicated	98.1	35.2	5.0
Inferred	11.1	33.2	5.5
Total Mineral Resource	109.2	35.0	5.1

CSA Global has determined the depleted Mineral Resource for Wessels at 31 December 2014 by deducting actual production to 30 September and forecast production to 31 December 2014, to be as provided below. These Mineral Resources are inclusive of Ore Reserves, estimated using a cut-off grade of 45 % Mn for the high grade portion of the Lower Body (LB) and 37.5% Mn for the rest of the LB and for the Upper Body (UB).

Wessels Mineral Resource estimate at 31 December, 2014

Mineral Resources	Tonnage (Wet Mt)	Mn %	Fe %
Measured	14.7	44.3	12.9
Indicated	125.2	42.2	16.8
Measured + Indicated	139.9	42.4	16.4
Inferred	0.0	-	-
Total Mineral Resources	139.9	42.4	16.4

Ore Reserves

Assumptions are used in estimating the ore production volumes, including appropriate allowances for ore loss and dilution (no dilution is considered for the underground Wessels Mine). Both mines have been successfully operating for considerable time (Mamatwan since 1964 and Wessels since 1973). There is capacity to produce and supply appropriate volumes and quality of products to satisfy the market forecasts. Production at the Hotazel operations is currently constrained by allocated rail capacity.

CSA Global accepts the Ore Reserves stated by Hotazel at 30 June 2014 and has depleted them to 31 December 2014. The Mamatwan Ore Reserves estimate based on the CP FY14 report and the FY15 LoA plan, depleted to 31 December 2014 is provided below.

Mamatwan Mine Ore Reserves estimate at 31 December 2014

Category	Ore type	Cut-off grade (% Mn)	Tonnes (Wet Mt)	Mn (%)	Fe (%)
Proved	MCN Zones	35	17.3	37.7	4.4
	X Zone	35	1.5	38.3	4.7
	Total Proved	35	18.7	37.7	4.4
Probable	MCN Zones	35	41.0	37.1	4.5
	X Zone	35	2.4	36.7	4.8
	Total Probable	35	43.4	37.1	4.5
Totals by Zone	MCN Zones	35	58.3	37.3	4.5
	X Zone	35	3.9	37.3	4.8
Total Ore Reserves		35	62.2	37.3	4.5

A cut-off grade of 35% Mn is used to define mineable ore blocks.

The Wessels Ore Reserves estimate based on the CP FY14 report and the FY15 LoA plan, depleted to 31 December 2014 is shown below. The tonnage is reported as wet metric tonnes.

Wessels Mine Ore Reserves estimate at 31 December 2014

Wessels Mine Area	Proved			Probable			Total		
	Tonnes (Wet Mt)	Mn (%)	Fe (%)	Tonnes (Wet Mt)	Mn (%)	Fe (%)	Tonnes (Wet Mt)	Mn (%)	Fe (%)
UB				46.2	41.4	18.2	46.2	41.4	18.2
LB	2.9	43.8	11.9	19.9	43.9	12.9	22.8	43.9	12.8
Total	2.9	43.8	11.9	66.1	42.2	16.6	69.0	42.2	16.4

A nominal cut-off grade of 37.5% Mn is used to define mineable ore blocks but material below the cut-off grade is included where it produces a saleable blended product.

Reconciliation methods are in place and data has been provided to CSA Global indicating acceptable performance of the Ore Reserves.

Risk Analysis

Generic risks considered by Hotazel management in their risk assessments are:

- Legal compliance with permitting, tenement conditions and other laws such as the Anti Corruption Act, which are being addressed by training.
- Risks associated with Mineral Resource estimation and long-term planning, which are addressed by audits and considered in this CPR.

No material key risks were identified by CSA Global. Risks are discussed in Section 3.5.9 (Mamatwan Mine) and Section 4.4.8 (Wessels Mine).

Opportunities to enhance the mining operation under consideration by Hotazel are:

- Remote control underground load and haul equipment for Wessels Mine.
- Relocation of the in-pit crusher at Mamatwan Mine to optimise ore and waste movements.
- Upgrading the Mamatwan Mine load and haul fleet.

Valuation

Valuation of the Ore Reserves has been carried out by CSA Global under the VALMIN Code (2005).

The assumptions used in estimating operating costs, including mining, processing, product transport, and site administration are reasonable based on provided historical data and examination of financial forecasts as part of the Valuation work done for this CPR.

Capital costs used in the financial models are considered reasonable for the proposed mine plans, development and construction schedules and the forecast production levels. There are no major unauthorised capital expenditures required to deliver the Ore Reserves.

CSA Global has determined Valuations for the Mamatwan Mine and the Wessels Mine of BHP Billiton based upon the stated Ore Reserves as at 31 December 2014.

The Base Case Value determined by CSA Global for BHP Billiton's 44.4% share of the Mamatwan Asset is US\$261 million. The Mamatwan Mine has an expected mine life of 17.5 years to the end of FY32. The Market or Fair Value for 100% of the Mamatwan Asset based on the Ore Reserves is therefore expected to lie in the range from US\$324M to US\$854M, with a most likely value of US\$587M. BHP Billiton's 44.4% share, rounded to an appropriate level of precision, is valued in the range from US\$140M to US\$380M with a most likely value of US\$260M.

The Base Case Value determined by CSA Global for BHP Billiton's 44.4% share of the Wessels Asset is US\$202 million. The Wessels Mine has an expected mine life of 46.5 years to the end of FY61. The Market or Fair Value for 100% of the Wessels Asset based on the Ore Reserves is therefore expected to lie in the range from US\$187M to US\$723M, with a most likely value of US\$454M. BHP Billiton's 44.4% share, rounded to an appropriate level of precision, is valued in the range from US\$80M to US\$320M with a most likely value of US\$200M.

ESMA Reporting Requirements

This Competent Person Report must comply with the rules and requirements of the Relevant Listing Authorities including, in the case of a UKLA listing, the European Securities and Markets Authority (ESMA)'s Recommendations on consistent implementation of Commission Regulation (EC) No 809/2004 implementing the Prospectus Directive. The following information is provided in compliance with ESMA Appendix II.

Clause iii) Resources and reserves:

- (3) The Mineral Resources include the Ore Reserves.

(4) No supporting assumptions are used in ensuring that mineral resource statements are deemed to be 'potentially economically mineable'. The Assets are operating mines and only Ore Reserves are valued.

(7) The Competent Persons for this CPR visited the Mamatwan Mine on 14 October and the Wessels Mine on 15 October 2014.

Clause ix) In relation to special factors that require reporting: Broad-Based Black Economic Empowerment is considered in Section 2.8.3.

Hotazel Mineral Resource and Ore Reserve Statements

This CPR includes information on Mineral Resources (inclusive of Ore Reserves) as reported by Mr E P Ferreira (SACNASP) and Mr C Nengovhela (SACNASP), and Ore Reserves as reported by Mr D Mathebula (SAIMM). The information is extracted from the BHP Billiton 2014 Annual Report (BHP Billiton, 2014) and is available to view on www.bhpbilliton.com.

Mr Ferreira, Mr Nengovhela and Mr Mathebula are full-time employees of BHP Billiton at the time of reporting and have the required qualifications and experience to qualify as Competent Persons for Mineral Resources under the 2012 Edition of the "Australasian Code for Reporting of Exploration Results, Mineral Resources and Ore Reserves" (JORC Code). The Competent Persons verify that their reports (Ferreira *et al*, 2014a, 2014b) are based on and fairly reflect the Mineral Resources and Ore Reserves information in the supporting documentation and agree with the form and context of the information presented.

BHP Billiton confirms that it is not aware of any new information or data that materially affects the information included in the original market announcements and, in the case of estimates of Mineral Resources and Ore Reserves, that all material assumptions and technical parameters underpinning the estimates in the relevant market announcements continue to apply and have not materially changed. BHP Billiton confirms that the form and context in which the Competent Persons' findings are presented have not been materially modified from the original market announcements.

Author and Reviewer Signatures

Principal Author:	Bill Shaw	Signature:	<p>Electronic signature not for duplication. Electronic signature not for duplication. Electronic signature not for duplication. Electronic signature not for duplication. Electronic signature not for duplication. Electronic signature not for duplication. Electronic signature not for duplication. Electronic signature not for duplication. Electronic signature not for duplication. Electronic signature not for duplication.</p> 
Valuation:	Paddy Reidy	Signature:	<p>Electronic signature not for duplication. Electronic signature not for duplication. Electronic signature not for duplication. Electronic signature not for duplication. Electronic signature not for duplication. Electronic signature not for duplication. Electronic signature not for duplication. Electronic signature not for duplication. Electronic signature not for duplication. Electronic signature not for duplication.</p> 
Contributors:	As listed in Section 1.3		
Principal Reviewer:	Dan Wholley	Signature:	<p>Electronic signature not for duplication. Electronic signature not for duplication. Electronic signature not for duplication. Electronic signature not for duplication. Electronic signature not for duplication. Electronic signature not for duplication. Electronic signature not for duplication. Electronic signature not for duplication. Electronic signature not for duplication. Electronic signature not for duplication.</p> 
CSA Global Authorisation:	Bill Shaw	Signature	<p>Electronic signature not for duplication. Electronic signature not for duplication. Electronic signature not for duplication. Electronic signature not for duplication. Electronic signature not for duplication. Electronic signature not for duplication. Electronic signature not for duplication. Electronic signature not for duplication. Electronic signature not for duplication. Electronic signature not for duplication.</p> 
		Date	5 March 2015

Revision:

Rev No.	Date	Revisions	Author	Approved

Contents

Executive Summary	I
Introduction	I
Social Licence to Mine	I
Mineral Resources	I
Ore Reserves	II
Risk Analysis	III
Valuation	IV
ESMA Reporting Requirements	IV
Hotazel Mineral Resource and Ore Reserve Statements	V
Author and Reviewer Signatures	VI
Contents	VII
1 Introduction	1
1.1 Terms of Reference	1
1.2 Reporting Standards	1
1.3 Report Authorship	2
1.4 Prior Association and Independence	3
1.5 Declarations and Limitations	3
1.6 Abbreviations	4
2 Hotazel Manganese Mines	6
2.1 Project History	6
2.2 Location and Access	6
2.3 Infrastructure	7
2.4 Power	7
2.5 Transnet Rail	8
2.6 Climate, Ecology and Physiography	9
2.7 Project Tenements	10
2.7.1 Mamatwan Mine Tenure	10
2.7.2 Wessels Tenements	11
2.7.3 Hotazel York and Middelplaats Tenements	11
2.8 Environment, Health and Social Licence to Operate	12
2.8.1 Environmental Legal Liability	12
2.8.2 Health, Safety, Environment and Community	13
2.8.3 Social License to Operate and BBBEE	13
2.8.4 Closure Liability	15
3 Mamatwan Open Pit Mine	17
3.1 Regional Geology	17
3.2 Local Geology	19
3.3 Mineral Resource Estimation	20
3.3.1 Drilling, Logging and Sampling	20
3.3.2 Geological Interpretation	24
3.3.3 Geostatistical Analysis and Estimation	29
3.3.4 Mineral Resource Classification and Statement	31
3.4 Mining	33
3.4.1 Mining Method and Equipment	33
3.4.2 Mine Infrastructure and Development	36
3.4.3 Rock Mechanics and Dumping	37
3.4.4 Water	37
3.4.5 Tailings	37
3.5 Ore Reserves	38
3.5.1 Processing	38

3.5.2	Life of Asset	39
3.5.3	Historical Production and Expenditures	42
3.5.4	Reconciliations over last three years	42
3.5.5	Comparison of the blast hole model with the resource model	44
3.5.6	Modifying Factors	44
3.5.7	Cut-off grade	45
3.5.8	Mine Schedule	45
3.5.9	Risks –Mamatwan Mine	47
3.5.10	Mamatwan Ore Reserves Statement	47
4	Wessels Underground Mine	48
4.1	Local Geology	48
4.2	Mineral Resource Estimation	48
4.2.1	Drilling, Logging and Sampling	48
4.2.2	Geological Interpretation	52
4.2.3	Geostatistical Analysis and Estimation	54
4.2.4	Mineral Resource Classification and Statement	56
4.3	Mining	58
4.3.1	Major Facilities	58
4.3.2	Mining Method and Equipment	59
4.3.3	Mine Production	62
4.3.4	Mine Infrastructure and Development	62
4.3.5	Rock Mechanics	62
4.3.6	Water	63
4.3.7	Tailings	63
4.3.8	Power, Ventilation, Escape Ways, Pumping	63
4.4	Ore Reserves	64
4.4.1	Processing	64
4.4.2	Life of Asset	64
4.4.3	Historical Production and Expenditures	67
4.4.4	Wessels reconciliations	69
4.4.5	Comparisons between Mamatwan and Wessels reconciliations	70
4.4.6	Modifying Factors	71
4.4.7	Mine Schedule	72
4.4.8	Risks – Wessels Mine	74
4.4.9	Wessels Ore Reserves Statement	74
5	Valuation of Ore Reserves	76
5.1	Valuation Methodology	76
5.2	Manganese Market and Outlook	76
5.3	Cash Flow Modelling and Assumptions	77
5.3.1	Commodity Pricing Assumptions	78
5.3.2	Exchange Rate Assumptions	79
5.3.3	Discount Rate Determination	80
5.3.4	Royalties and Taxes	81
5.4	Mamatwan Asset Valuation	81
5.4.1	Mamatwan Ore Production Physicals	81
5.4.2	Mamatwan Operating Costs	82
5.4.3	Mamatwan Capital Costs	83
5.4.4	Mamatwan Undiscounted Cash Flows – Base Case	83
5.4.5	Mamatwan NPV Valuation – Base Case	83
5.4.6	Mamatwan NPV Valuation – Range Analysis	84
5.4.7	Mamatwan Sensitivity Analysis	84
5.4.8	Mamatwan Project Opportunities	87
5.4.9	Mamatwan Valuation Summary	87
5.5	Wessels Asset Valuation	88
5.5.1	Wessels Ore Production Physicals	88

5.5.2	Wessels Operating Costs	89
5.5.3	Wessels Capital Costs	89
5.5.4	Wessels Undiscounted Cash Flows – Base Case	90
5.5.5	Wessels NPV Valuation – Base Case	90
5.5.6	Wessels NPV Valuation – Range Analysis	91
5.5.7	Wessels Sensitivity Analysis	91
5.5.8	Wessels Project Opportunities	94
5.5.9	Wessels Valuation Summary	94
6	References	95

Figures

Figure 1	Location plan showing Mamatwan Mine and Wessels Mine	7
Figure 2	Location plan showing the Hotazel operations in relation to the transport corridors and ports for product shipment	8
Figure 3	Average daily temperature at Hotazel Township	9
Figure 4	Geological structures and spatial relationship between	17
Figure 5	Regional (top) and local (bottom) Mamatwan and Wessels stratigraphic profile	18
Figure 6	Mamatwan manganese bearing horizons and Zones	20
Figure 7	Plan view of drill holes used in the Mineral Resource estimate	22
Figure 8	Plan view of drill hole collars in Mamatwan Mine	25
Figure 9	Cross section A facing north centred on -27,850N -2,400E	26
Figure 10	Cross section B facing north centred on -27,965N -2,365E	27
Figure 11	Cross section C facing north centred on -29,080N -2,240E	28
Figure 12	Example of Mn variogram for seam C	30
Figure 13	3D view of the MCN Zones coloured by Mineral Resource classification	32
Figure 14	Mamatwan mine layout, aerial view facing northwest	34
Figure 15	Schematic section through the pit, indicating cuts and thicknesses	35
Figure 16	Mining face layout	36
Figure 17	Mamatwan in-pit crusher and backfill	36
Figure 18	Typical waste dump geotechnical design	37
Figure 19	Mamatwan process flow sheet	38
Figure 20	Mining schedule showing annual plan increments	39
Figure 21	ROM tonnes and feed grade	41
Figure 22	Mamatwan mine overburden profile	41
Figure 23	Mamatwan Mine tonnage and grade profile	46
Figure 24	Mamatwan Mine production profile	46
Figure 25	Plan view of 18 new drill holes used in the Mineral Resource estimate	49
Figure 26	Plan view of Wessels drill holes	50
Figure 27	3D view of drill hole data and Wessels mining Blocks (vertical exaggeration x3)	53
Figure 28	3D view facing north, showing UB (blue) and LB (green) wireframes and drilling	53
Figure 29	3D view facing north of LB Mineral Resource classification, with drill hole traces (vertical exaggeration x3)	57
Figure 30	West- east cross section indicating structural zones in Wessels Mine	59
Figure 31	Plan indicating structural zones	60
Figure 32	Development phase of the room and pillar mining layout	61
Figure 33	Ore flow at Wessels Mine and washing plant	64
Figure 34	FY15 LoA plan showing tonnes hoisted by mining area	65
Figure 35	Tonnes hoisted by ore type classification in FY15 LoA plan	66
Figure 36	Wessels Mine production history showing annual actual and budget figures and that monthly actuals (blue bars) are less than monthly budgets (red line)	68
Figure 37	Wessels tonnage reconciliation – FY14	70
Figure 38	Comparative reconciliations of Mamatwan (left) and Wessels (right) showing tonnes, Mn grade and Fe grade, all in relative terms, for F1, F2 and F3.	71
Figure 39	Mining areas influenced by middling (inter-layer) thicknesses of less than 10 m	73
Figure 40	Below COG ore included in the Life of Mine plan	73
Figure 41	CSA Global forecast of Mn prices	79

Figure 42	Historical and forecast ZAR/US\$ exchange rates	80
Figure 43	Mamatwan ore production summary	82
Figure 44	Mamatwan cash costs	82
Figure 45	Mamatwan capital costs	83
Figure 46	Mamatwan undiscounted cash flows – Base Case	83
Figure 47	Mamatwan tornado diagram of sensitivities of Base Case to key drivers (US\$ M)	85
Figure 48	Mamatwan revenue and exchange rate variance to Base Case	85
Figure 49	Mamatwan operating costs and exchange rate variance to Base Case	86
Figure 50	Mamatwan discount rate and exchange rate variance to Base Case	86
Figure 51	Mamatwan product grade and exchange rate variance to Base Case	86
Figure 52	Mamatwan capital costs and exchange rate variance to Base Case	87
Figure 53	Wessels ore production summary	88
Figure 54	Wessels operating costs	89
Figure 55	Wessels capital costs	89
Figure 56	Wessels undiscounted cash flows – Base Case	90
Figure 57	Wessels tornado diagram of sensitivities of Base Case to key drivers (US\$ M)	92
Figure 58	Wessels revenue and exchange rate variance to Base Case	92
Figure 59	Wessels operating costs and exchange rate variance to Base Case	93
Figure 60	Wessels discount rate and exchange rate variance to Base Case	93
Figure 61	Wessels product grade and exchange rate variance to Base Case	93
Figure 62	Wessels capital costs and exchange rate variance to Base Case	94

Tables

Table 1	Tenements related to the Mamatwan Mine	10
Table 2	Tenements related to the Wessels Mine	11
Table 3	Tenements related to the Hotazel York and Middelplaats Projects	12
Table 4	Closure provisions by Mine	16
Table 5	Summary of the Mamatwan drill hole database at October 2014	21
Table 6	Assays in the Mamatwan drill hole database by Zone at October 2014	21
Table 7	Summary of drill hole sample statistics for all Mn seams used in the Mineral Resource estimate	29
Table 8	Block model parameters	30
Table 9	Criteria used to classify the Mamatwan Mineral Resource estimate	31
Table 10	Mamatwan Mineral Resources at 30 June, 2014	33
Table 11	Mamatwan Mineral Resources depleted to 31 December, 2014	33
Table 12	Mamatwan major equipment fleet	35
Table 13	Summary of Mamatwan FY15 LoA plan	40
Table 14	Summary of last three years production and costs	42
Table 15	Historic tonnages used for reconciliation over the last three years	43
Table 16	Mamatwan F1 reconciliation: blast holes against Mineral Resource model	44
Table 17	Mamatwan Mine Modifying Factors in the FY15 LoA plan	45
Table 18	Mamatwan Mine Ore Reserves estimate at 31 December 2014	47
Table 19	Summary of the Wessels drill hole database at October 2014 indicating data used in the Mineral Resource estimate (MRE)	51
Table 20	Sample data in the Wessels surface drill hole database at October 2014, indicating data used in the Mineral Resource estimate (MRE)	51
Table 21	Raw drill hole sample statistics for UB and LB combined in the Mineral Resource	54
Table 22	Block model parameters	55
Table 23	Criteria used to classify the Wessels Mineral Resources	56
Table 24	Wessels Mineral Resource estimate at 30 June, 2014	58
Table 25	Wessels Mineral Resource estimate at 31 December, 2014	58
Table 26	Summary of ROM tonnes hoisted based on FY15 LoA plan	66
Table 27	Summary of ROM tonnes hoisted by ore product type, based on FY15 LoA plan	67
Table 28	Actual vs budgeted tonnes hoisted – last three years	68
Table 29	Nominal cash costs of production – last three years	68
Table 30	Production data used in FY14 reconciliation	69



Table 31	Mining Modifying Factors	72
Table 32	Ore Reserve depletion – June 2014 to December 2014	74
Table 33	Wessels Mine Ore Reserves estimate at 31 December 2014	75
Table 34	Annual average manganese prices for the 44% SL Mn benchmark	77
Table 35	Key assumptions in deriving a Base Case value for the Hotazel Ore Reserves	78
Table 36	Base case value for Mamatwan Asset over the Life Of Mine to end of FY32	84
Table 37	Range analysis of the Mamatwan Asset value over the Life Of Mine to end of FY27	84
Table 38	Base case value for Wessels Asset over the Life Of Mine to end of FY61	90
Table 39	Range analysis of the Wessels Asset value over the Life Of Mine to end of FY61	91

1 Introduction

1.1 Terms of Reference

BHP Billiton is a Dual Listed Company (DLC) comprising BHP Billiton Limited and BHP Billiton Plc. BHP Billiton was created through the DLC merger of BHP Limited (now BHP Billiton Limited) and Billiton Plc (now BHP Billiton Plc), which was concluded on 29 June 2001.

BHP Billiton Limited has a primary listing on the Australian Securities Exchange (ASX) and BHP Billiton Plc has a primary listing on the London Stock Exchange, with a secondary listing on the Johannesburg Stock Exchange. In addition BHP Billiton has two American Depositary Receipt listings on the New York Stock Exchange. BHP Billiton (which for the purposes of this report includes BHP Billiton Limited and BHP Billiton Plc) is considering the demerger of certain aluminium, coal, manganese, nickel and silver assets (Demerger).

The demerged assets will be held by South32 Limited (South32). It is currently intended that South32 will be listed on the ASX, the Johannesburg Stock Exchange (JSE), and on the Official List of the UKLA (together, the Relevant Listing Authorities).

If BHP Billiton pursues the Demerger, public market listing documentation must be prepared to list South32 in accordance with the rules of the Relevant Listing Authorities. BHP Billiton has commissioned CSA Global to compile a Competent Person Report on their manganese Mineral Resources and Ore Reserves. This report is for the mining operations of Hotazel Manganese Mines (Pty) Ltd (referred to in this report as Hotazel) and may be included in the documentation relating to the Relevant Listing Authorities' admission of South32's shares to listing, including an ASX Information Memorandum, a JSE pre-listing statement and a UK prospectus (the Listing Documentation).

This report complies with the rules and requirements of the Relevant Listing Authorities (including, in the case of a UKLA listing, the European Securities and Markets Authority's Recommendations on consistent implementation of Commission Regulation (EC) No 809/2004 implementing the Prospectus Directive (the ESMA Recommendations).

The Hotazel mining operations are located in the Republic of South Africa. The material data for the project area is discussed in the report and tenement details are provided. CSA Global has been formally advised by Hotazel that the project tenements are held in good standing (Section 2.7).

A brief overview of the projects is outlined in the report. An independent Valuation of the Ore Reserves for the Mamatwan Mine and the Wessels Mine is also provided.

1.2 Reporting Standards

This report is consistent with the ESMA Recommendations as prescribed in the Commission Regulation (EC) No 809/2004 implementing the Prospectus Directive.

BHP Billiton and CSA Global have used the JORC Code (2012) for reporting Mineral Resources and Ore Reserves.

The Valuation has been prepared in accordance with the VALMIN Code (2005), which is binding upon Members of the Australasian Institute of Mining and Metallurgy (AusIMM) and the Australian Institute of Geoscientists (AIG).

The authors have taken due note of the rules and guidelines issued by such bodies as the Australian Securities and Investments Commission (ASIC) and the ASX, including ASIC Regulatory Guide 111 – Content of Expert Reports and ASIC Regulatory Guide 112 – Independence of Experts.

1.3 Report Authorship

This report has been prepared by CSA Global, a privately-owned consulting company that has been operating from Perth, Western Australia for 30 years.

CSA Global provides multi-disciplinary services to clients in the global resources industry. CSA Global services include project generation, exploration, resource estimation, project evaluation, development studies, mining operations assistance, and corporate consulting advice such as valuations and independent technical reports. CSA Global has worked for major clients globally and many junior resource companies. CSA Global personnel have been involved in the preparation of independent reports for listed companies in most international mining jurisdictions.

The principal authors of this report are Dr Bill Shaw, Global leader - Mining and Mr Padraig Reidy, Associate Consultant.

Dr Shaw is responsible for the geology, Mineral Resources and Ore Reserves and factors that impact on them.

Bill Shaw, PhD, MGeoSc (Mineral Economics), BSc (Geology), FAIG, RPGeo (registration number 10026), FAusIMM, CPGeo (registration number 104890), has over 40 years of experience in economic geology, resource evaluation and mining. He has audited Mineral Resources and Ore Reserves to international standards including the Australasian JORC, US Securities and Exchange Commission, Canadian NI 43-101 and South African SAMREC Codes. He has been involved in the management of large evaluation projects and major audits. He is a full-time employee of CSA Global, is currently on the Joint Ore Reserves Committee (JORC) and is President of the Australian Geoscience Council.

Dr Shaw has the relevant qualifications, experience, competence and independence to be considered an Expert under the definitions provided in the VALMIN Code and a Competent Person as defined in the JORC Code (2012).

Mr Reidy is responsible for the Valuation of the Ore Reserves.

Paddy Reidy, MSc (Mineral and Energy Economics), BA (Hons, Geology), MAusIMM, has over 17 years of experience in the international resource sector with corporate experience as CEO of an ASX listed junior exploration company, and consulting experience as Principal Consultant Geologist and Associate Consultant with CSA Global. He has extensive experience in project management, scoping and feasibility studies, project review, mineral asset valuation and Mineral Resource estimation. He has held senior positions with Rio Tinto Iron Ore as an Analyst, and with Gold Fields Ltd (St Ives) as a Business Analyst and Senior Geologist and is currently an Associate of CSA Global.

Mr Reidy has the relevant qualifications, experience, competence and independence to be considered an Expert under the definitions provided in the VALMIN Code and a Competent Person as defined in the JORC Code (2012).

Dr Shaw and Mr Reidy have been supported by other contributing authors in specific discipline areas, as follows:

- Mr Jaco Lotheringen – Principal Mining Engineer with Ukwazi, reviewed the Ore Reserves and provided comments related to mining.

- Mr Malcolm Titley – Principal Resource Consultant with CSA Global, reviewed the Mineral Resource estimates and provided comments on methodology and results.
- Mr Andrew Johnstone and Mr Jacques Harris – Principal Consultants with GCS, reviewed and reported on issues related to environment and social license to mine.
- The Valuation was reviewed by Ms Rebecca Barry, Principal Consultant with CSA Global.
- Peer review of this report has been undertaken by Mr Daniel Wholley who is Global Operations Manager and a Director of CSA Global.

1.4 Prior Association and Independence

Neither CSA Global, nor the authors of this report, has or has had previously, any material interest in BHP Billiton or the mineral properties in which BHP Billiton has an interest. CSA Global's relationship with BHP Billiton is solely one of professional association between client and independent consultant.

CSA Global is an independent geological and mining consultancy. This report is prepared in return for professional fees based upon agreed commercial rates and the payment of these fees is not contingent on the results of this report.

No member or employee of CSA Global is, or is intended to be, a director, officer or other direct employee of BHP Billiton. Several CSA Global employees have minor shareholdings in BHP Billiton. Such shareholdings were declared and considered not material to the independence of this report. The lead author of this report, Dr Bill Shaw, holds a beneficial interest in 1200 BHP Billiton shares. There is no agreement between CSA Global and BHP Billiton regarding CSA Global conducting further work for BHP Billiton.

1.5 Declarations and Limitations

This Competent Person Report has been prepared by CSA Global at the request of, and for the sole benefit of BHP Billiton and South32 and can be relied upon by their shareholders. Its purpose is to provide an independent technical assessment and valuation of BHP Billiton's Hotazel operations in South Africa. The Report is to be included in its entirety within the Listing Documents to be prepared by BHP Billiton and South32 (or their advisors) in connection with the Demerger of Hotazel Mines from BHP Billiton. It is not intended to serve any purpose beyond that stated and should not be relied upon for any other purpose.

CSA Global has consented to the inclusion of the Report within the Listing Documents in the form and context in which it is to appear. Neither the whole nor any part of the Report may be included in or with, or attached to any other documents, circular, resolution, letter or statement without the prior written consent of CSA Global as to the form and context in which it is to appear.

This report has been compiled based on information available up to and including the date of this report. The statements and opinions are based on the reference date of 31 December 2014 and could alter over time depending on exploration results, mineral prices and other relevant market factors.

The information in this report that relates to Mineral Resources and Ore Reserves has been compiled by Dr Bill Shaw who is a full-time employee of CSA Global. Dr Shaw has sufficient experience relevant to the style of mineralisation and type of deposit under consideration and to the activity which he is undertaking to qualify as a Competent Person as defined in the JORC Code

(2012). Dr Shaw consents to the disclosure of this information in this report in the form and context in which it appears.

The information in this report that relates to Valuation of the Ore Reserves has been compiled by Mr Paddy Reidy who is an Associate of CSA Global. Mr Reidy has sufficient experience relevant to the style of mineralisation and type of deposit under consideration and to the activity which he is undertaking to qualify as an Expert as defined in the VALMIN Code (2005). Mr Reidy consents to the disclosure of this information in this report in the form and context in which it appears.

1.6 Abbreviations

AIG	Australian Institute of Geoscientists
AMIS	African Mineral Standards
ASIC	Australian Securities and Investments Commission
ASX	Australian Securities Exchange
AusIMM	Australasian Institute of Mining and Metallurgy
BBBEE	Broad-Based Black Economic Empowerment
CIF	cost insurance freight
CPR	Competent Person Report
CRM	certified reference material
CSA Global	CSA Global Pty Ltd
DCF	discounted cash flow
CSR	Corporate Social Responsibility
DLC	dual listed company
DMR	Department of Mineral Resources
DMS	dense media separation
EBIT	earnings before interest and tax
EME	earth moving equipment
EMP	Environmental Management Plan
ESMA	European Securities and Markets Authority
FEL	front end loader
FY14	financial year ending 30 June 2014
GLD	Group Level Documents of BHP Billiton
HMM	Hotazel Manganese Mines Pty Ltd
Hotazel	the manganese mining operations of HMM of which only Mamatwan Mine and Wessels Mine have Ore Reserves
IDS	inverse distance squared (method for resource estimation)
IPART	Independent Pricing and Regulatory Tribunal
JORC	Joint Ore Reserves Committee
JSE	Johannesburg Stock Exchange
LB	Lower Body
LHD	load haul dump mining machines
LIMS	laboratory information management system
LoA	Life of Asset
LOI	Loss on Ignition (a method of assaying)
MPRDA	Minerals and Petroleum Resources Development Act, Act No. 28 of 2002
MRA	Mining Right Application
MRE	Mineral Resource estimate
NEMAQA	South African regulatory operation licenses for air emissions



NEMWA	South African regulatory operation licenses for waste disposal
NPV	net present value
NWA	South African regulatory operation licenses for water use
OPP	ore processing plant
PVR	July 2014 Portfolio Valuation Review (Hotazel financial modelling)
QAQC	quality assurance and quality control (for sampling and assaying)
QKNA	quantitative kriging neighbourhood analysis, studies to validate Mineral Resource estimation
RBA	Reserve Bank of Australia
ROM	run of mine ore
South32	South32 Limited
TSF	tailings storage facility
UB	Upper Body
UKLA	United Kingdom Listing Authority
US\$ M	millions of US Dollars
WACC	weighted average cost of capital
ZAR M	millions of African Rand
ZAR/US\$	South African Rand per US Dollar, exchange rate

Units of measurement

dmtu	dry metric tonne unit
ha	hectares
km	kilometres
km ²	square kilometres
kt	thousand tonnes
ktpa	thousands of tonnes a year
mm	millimetres
Mt	million tonnes
Mtpa	millions of tonnes a year
mtu	metric tonne unit
sq km	square kilometres
t	tonnes
t/m ³	tonnes per cubic metre (for <i>in situ</i> dry bulk density)
tph	tonnes per hour

2 Hotazel Manganese Mines

2.1 Project History

The Kalahari Basin in Northern Cape Province, South Africa hosts 80% of the world's manganese resource endowment. The manganese mines operated by BHP Billiton are located within the Joe Morolong municipality and consist of two manganese mines: the open pit Mamatwan Mine and the underground Wessels Mine which together are referred to as the Hotazel operations of BHP Billiton's South Africa Manganese business.

Hotazel also has two non-operating mines, Middelpplaats and Old Hotazel York. Under instruction from BHP Billiton, CSA Global has not undertaken any assessment of these two operations, nor of the Metalloys smelter in Johannesburg, and these are not included in the Valuation of Hotazel. The Metalloys smelter is operated as a separate entity and is not solely reliant on the ore from Hotazel, nor is the smelter the sole customer of Hotazel.

BHP Billiton owns 60% and Anglo American owns 40% of Samancor Holdings Pty Ltd. This entity owns 76% of Samancor Manganese (Pty) Ltd with the remaining 26% held by Broad-Based Black Economic Empowerment (BBBEE) entities, which means that BHP Billiton has an effective interest of 44.4% (60% of 74%) in the two Hotazel mines that have Ore Reserves.

The operations provide employment for approximately 2000 people as employees and contractors.

Mined ore is processed into a saleable product through a crushing and wet screening operation, with some ore undergoing further processing in the form of dense media separation and sintering. Approximately 25 per cent of the ore mined is beneficiated into alloy at Metalloys, with the rest being exported via road and rail through Port Elizabeth (approximately 950 km) and Durban (approximately 1,100 km).

The Mamatwan Mine was opened in 1964 and is an open pit mine using the terrace mining method (discussed in detail in Section 3.4.1). According to the FY15 LoA plan (BHP Billiton, 2013) on which the current CP FY14 Ore Reserves (Ferreira *et al*, 2014a) are based. Mamatwan has a current Ore Reserves life of 17.5 years.

The Wessels mine was opened in in 1973 and produces higher grade ore, which is mined at 300 m below surface (discussed in detail in Section 4.2). According to the FY15 LoA plan (BHP Billiton, 2013) on which the current CP FY14 Ore Reserves (Ferreira *et al*, 2014b) are based, Wessels has a current Ore Reserves life of 46.5 years.

2.2 Location and Access

Mamatwan Mine is located approximately 25 km south of the town of Hotazel, 40 km north of Kathu and 55 km west of Kuruman, 600 km west of Johannesburg. The mine is on the farms of Mamatwan, Goold and Sinterfontein. Two provincial roads lie to the south of the mine. The road R31 between Kuruman and Hotazel, and the road N14 between Kuruman, Kathu and Olifantshoek.

Wessels mine is located at the northern end of the Kalahari Manganese Field, 80 km northwest of Kuruman.

The Mamatwan Mine and Wessels Mine locations are shown in Figure 1.

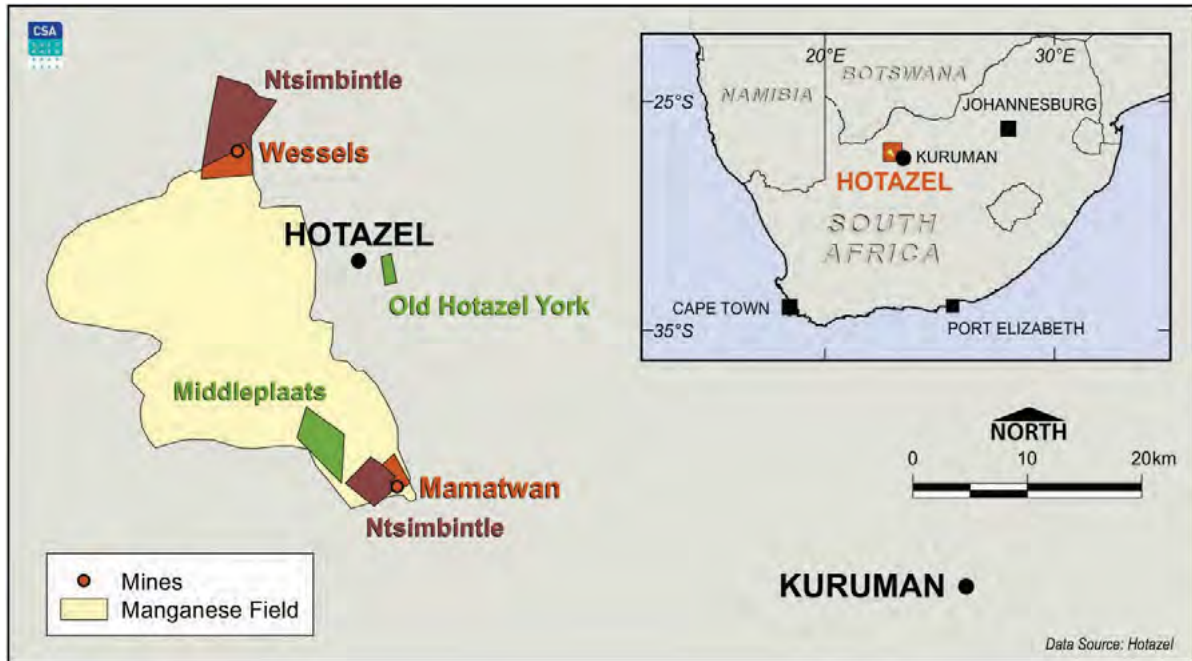

Figure 1 Location plan showing Mamatwan Mine and Wessels Mine
The Kalahari Manganese Field is shown in yellow

2.3 Infrastructure

According to the Mamatwan Environmental Management Plan (EMP), the current estimated total land disturbed for Mamatwan mine is 651 ha, which mainly consists of the mining pits and the supporting infrastructure (workshops, offices, conveyor belt systems, processing plants, waste disposal facilities, stockpiles and mine residue deposits). The site can be accessed via the R31 or the N14 roads, and ore is transported off-site using an existing railway line. Water treatment and sewerage treatment are also done on site.

The current estimated total land disturbed for the Wessels Mine is 149 ha, and this footprint consists mainly of product stockpiles, roads, slimes dams, waste rock dumps, shafts, and infrastructure (workshops, offices, conveyor belt systems, and a processing plant).

2.4 Power

In recent years electricity generation in South Africa has not been reliable. Mamatwan Mine draws significant power from the national utility Eskom (in FY14 up to 5 Mkw/h a month with a 10 MVA draw). It is expected that there will be two outages a year lasting one shift, generally advised in advance. There are generators on site supporting the Train Loading station and Reclaimer; as well as the Laboratory and other facilities for which guaranteed continuous power is required to ensure production.

The Wessels Mine has an agreement with Eskom whereby on request Hotazel will curtail demand by 10 to 20% of the maximum demand (9 MVA), in return for removal from the load-shedding schedule. This reduction occurs about six times a year and has some impact on production (no conveying of ore from underground) but it means that the mine can decide where and how to reduce load.

Wessels Mine experiences an average of 12 power dips a year, mostly in the rainy season as a result of lightning. The effect on mining activities is that the ventilation fans are interrupted and must be restarted. Standby diesel powered units are available to ensure operation of the network servers, Operational Control Centre, shaft winder and load-out station. Underground rescue stations are all linked to diesel compressors to supply fresh air.

2.5 Transnet Rail

Transnet is the state-owned, only rail service provider for the shipment of ore from the Kalahari region to the ports. Some material is moved on road by trucks, especially when rail capacity has been reduced. The transport corridors are shown in Figure 2.

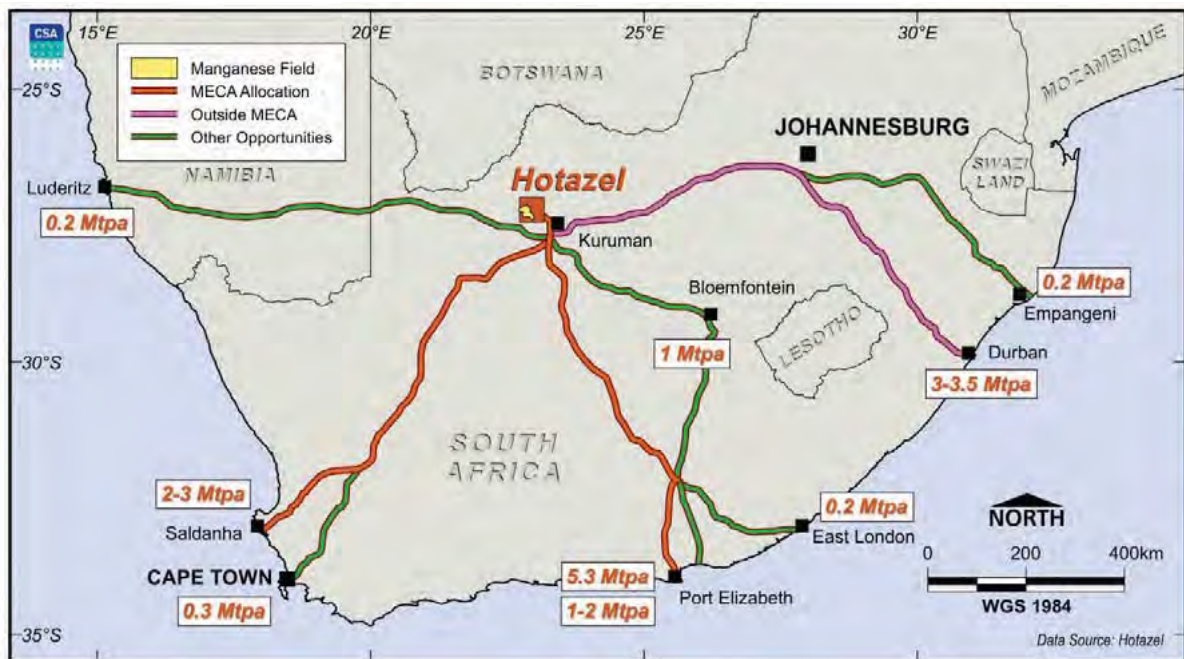

Figure 2 Location plan showing the Hotazel operations in relation to the transport corridors and ports for product shipment

The allocation of rail capacity is done by Transnet to all the producers in the Kalahari. Rail allocation to Hotazel constrains how much the Mamatwan and Wessels Mines can sell in a particular period. This impacts the production schedule but not the Ore Reserves, so it is not applied as a modifying factor. Hotazel has designed the current mining strategy to maximise revenue, which means that highest grade material is preferentially mined and railed. Without rail constraints, more high grade material, and lower grade material such as the Mamatwan Top Cut (see Section 3.5.8), could be mined and shipped as a product earlier.

Ore is railed to three ports for export mostly to Asia and Europe:

- Port Elizabeth is a Transnet operated port approximately 1,000 km from the Hotazel mines.
- Durban port is privately operated, approximately 1,200 km from the mines.
- Saldanha is a Transnet operated port, approximately 900 km from the mines.

Transnet has approved an expansion at Coega port which will create additional capacity of 16 Mtpa for ore exports by 2019, some of which will be available to Hotazel under long term take or pay contracts.

Contract negotiations between Hotazel and Transnet are in progress following the letter of award for rail volumes for the next 5 years. An agreement is expected to be concluded in the 1st quarter of calendar year 2015. The impact of the rail allocation on the business is captured in the Life of Asset plans and reflected in the volumes scheduled for each of the operations.

In a letter dated 30 September 2014 Hotazel was allocated 1.45 Mtpa, subject to the following conditions:

1. 80% of the allocated capacity will be committed, and the remaining 20% will be on an uncommitted basis. The rationale behind this is that Transnet may claw back some uncommitted capacity from time to time to enable additional participants into the channels (transport corridors).
2. The increased number of qualified customers that will be contracting with Transnet has rendered it unfeasible to accommodate all participants through one specific channel.
3. This allocation is subject to Hotazel's ability to successfully conclude a transport agreement with Transnet.
4. This capacity is allocated over a five year period, and may be extended as and when required to coincide with implementation of the 16 Mtpa rail expansion project.

Hotazel has not indicated to CSA Global that there is any expectation that this agreement will not be concluded or is otherwise a risk to continued product shipments.

2.6 Climate, Ecology and Physiography

The Kalahari Region vegetation consists of Montane Karoo grassy shrublands, Karoo grassy dwarf shrublands, Karoo succulent dwarf shrublands, and riparian thicket. High elevation (1,800 m) and relatively high rainfall (406 mm) impact on the vegetation.

There is increasing aridity away from the escarpment edge and Motane Karoo dwarf shrublands replace these mesic communities. At elevations below 800 m the precipitation is very low (175 mm) and uncertain. Hotazel normally receives about 223 mm of rain a year, mostly during summer. It receives the lowest rainfall (0 mm) in June and the highest (50 mm) in February. The monthly distribution of average daily maximum temperatures (Figure 3) shows that the average midday temperatures for Hotazel range from 19.1°C in June to 33.2°C in January.

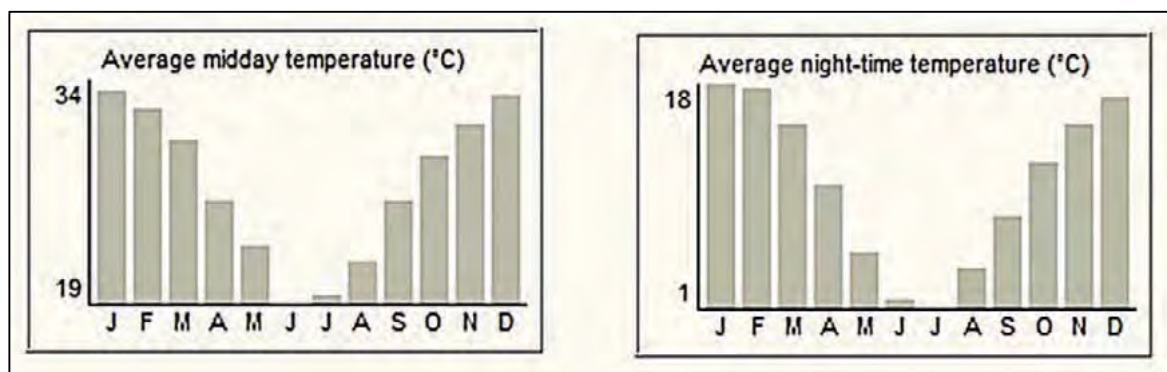

Figure 3 Average daily temperature at Hotazel Township
Source: http://www.saexplorer.co.za/south-africa/climate/hotazel_climate.asp

2.7 Project Tenements

Hotazel holds two mining licenses (Mamatwan and Wessels) and one prospecting right (Hotazel York):

- The Mamatwan mining right (Right No. 04/2006) covers an area of 1,103 ha and is valid until 5 October 2035.
- The Wessels mining right (Right No. 03/2006) covers an area of 1,069 ha and is valid until 5 October 2035.
- The Hotazel York prospecting right, which covers 146 ha, was renewed on 17 July 2014 and is valid for another three years in line with the Mineral and Petroleum Resources Development Act, Act 28 of 2002 (MPRDA).

2.7.1 Mamatwan Mine Tenure

Samancor Manganese (Pty) Ltd (in which BHP Billiton has a 60% interest) and Ntsimbintle Mining (Pty) Ltd entered into an agreement whereby Samancor Manganese (Pty) Ltd (through Hotazel Manganese Mines (Pty) Ltd) acquired Ntsimbintle's Prospecting Rights adjacent to the Mamatwan Mining Area, and similar rights adjoining Wessels Mine, in exchange for equity in Hotazel Manganese Mines (Pty) Ltd, a subsidiary of Samancor Manganese (Pty) Ltd. The rights have been transferred to and are now held by a new company called Hotazel Manganese Mines (Pty) Ltd (HMM). Between 2007 and 2009 Samancor entered into several transactions to meet its BBBEE ownership obligations. The initial transaction involved the divestment by Samancor of the Mamatwan and Wessels Mines and the divestment by Ntsimbintle of prospecting rights adjacent to those mines, to HMM in return for 91% and 9% of the equity in HMM, respectively. Following the contractual and regulatory transfer from Ntsimbintle to HMM, the rights were registered at the Department of Mineral Resources on 12 July 2012. The current mining right (as amended), the MM A. Mining Right, reflects the addition of the properties which formed part of the Prospecting Right – NC 014 PR, 4 October 2006.

The Mamatwan tenements are listed in Table 1.

Table 1 Tenements related to the Mamatwan Mine

Tenement	Holder	Date of commencement	Date of expiry	Surface rights holder(s)
Portion 4 of the Farm Adams 328 in the district of Kuruman	The Holder of MM A. Mining Right – Hotazel Manganese Mines (Pty) Ltd. (Reg No. 2007/004878/07)	6 October 2005	5 October 2035	Hotazel Manganese Mines (Pty) Ltd
Portion 5 and Portion 6 of the Farm Goold 329 in the district of Kuruman	The Holder of MM A. Mining Right – Hotazel Manganese Mines (Pty) Ltd. (Reg No. 2007/004878/07)	6 October 2005	5 October 2035	Portion 5 – Hotazel Manganese Mines (Pty) Ltd Portion 6 – Theresia and Cornelia Steyn
Portion of Portion 1 and Portion of Portion 2 of the Farm Mamatwan 331 in the district of Kuruman	The Holder of MM A. Mining Right – Hotazel Manganese Mines (Pty) Ltd. (Reg No. 2007/004878/07)	6 October 2005	5 October 2035	Portion 1 and 2 - Hotazel Manganese Mines (Pty) Ltd

Tenement	Holder	Date of commencement	Date of expiry	Surface rights holder(s)
The Farm Sinterfontein 748 in the district of Kuruman	The Holder of MM A. Mining Right – Hotazel Manganese Mines (Pty) Ltd. (Reg No. 2007/004878/07)	6 October 2005	5 October 2035	Hotazel Manganese Mines (Pty) Ltd
Portion 3 of the Farm Moab 700 in the district of Kuruman	The Holder of MM A. Mining Right – Hotazel Manganese Mines (Pty) Ltd. (Reg No. 2007/004878/07)	6 October 2005	5 October 2035	Hotazel Manganese Mines (Pty) Ltd

2.7.2 Wessels Tenements

As explained above for Mamatwan, the entity Hotazel Manganese Mines (Pty) Ltd now holds the tenements and prospecting rights relating to the Wessels Mine (Table 2).

Table 2 Tenements related to the Wessels Mine

Tenement	Holder	Date of commencement	Date of expiry	Surface rights holder(s)
The Farm Wessels 227 in the district of Kuruman	The Holder of MM A. Mining Right – Hotazel Manganese Mines (Pty) Ltd. (Reg No. 2007/004878/07)	6 October 2005	5 October 2035	Hotazel Manganese Mines (Pty) Ltd
Portions 1 and 2 of the Farm Dibiaghomo 226 in the district of Kuruman	The Holder of MM A. Mining Right – Hotazel Manganese Mines (Pty) Ltd. (Reg No. 2007/004878/07)	6 October 2005	5 October 2035	Hotazel Manganese Mines (Pty) Ltd
Portion 1 of the Farm Dikgatlong 268 in the district of Kuruman.	The Holder of MM A. Mining Right – Hotazel Manganese Mines (Pty) Ltd. (Reg No. 2007/004878/07)	6 October 2005	5 October 2035	Hotazel Manganese Mines (Pty) Ltd

2.7.3 Hotazel York and Middelplaats Tenements

A notarial deed of cession of prospecting rights dated 2007 refers to the passing of the Hotazel York Prospecting Right PR 545/2007 (HYM Pros Right) and the Middelplaats Prospecting Right – PR 347/2007, 26 January 2007 (MPM Pros Right), from Samancor Chrome Limited to Samancor Manganese (Pty) Ltd. The HYM Pros Right became effective on 26 January 2007; a Mining Right application lodged to mine the Middelplaats resource is still pending (Table 3).

Table 3 Tenements related to the Hotazel York and Middelpplaats Projects

Tenement	Holder	Date of commencement	Date of expiry	Surface rights holder(s)
Portion L1 (Portion of Portion 1) of the Farm Hotazel 280 in the district of Kuruman	Hotazel Manganese Mines (Pty) Ltd	HYM Pros Right –17 July 2014	HYM Pros Right – 16 July 2017	Portion 1 – Kerkraad van die NG Gemeente Kalahari (Hotazel)
Portion L1 (Portion of Portion 1) of the Farm York 279 in the district of Kuruman	Hotazel Manganese Mines (Pty) Ltd	HYM Pros Right –17 July 2014	HYM Pros Right – 16 July 2017	Portion 1 - Hotazel Manganese Mines (Pty) Ltd
Remaining Extent of the Farm Middelpplaats 332 in the district of Kuruman	Samancor Manganese (Pty) Ltd.	Mining Right with Minister for approval	Mining Right with Minister for approval	Saltrim Ranches (Pty) Ltd.

2.8 Environment, Health and Social Licence to Operate

2.8.1 Environmental Legal Liability

The aim of legal liability regimes (i.e. environmental legal risk) is to promote adherence to environmental principles such as precaution, prevention, duty of care and the polluter pays, as contained in environmental legislation. Every organisation has a responsibility to identify existing and emerging legislation relevant to its business and ensure that risks that may arise from the compliance requirements are well understood by the board and management.

Sound governance identifies and monitors the responsibilities and potential liabilities in terms of relevant legislative provisions and the conditions of all licences, approvals, authorisations and legal documents (e.g. the Environmental Management Plan).

The legal responsibilities of a mine originate in environmental legislation. The extent of potential liability is measured against the penalties for non-compliance. In other words, the law must be used as guideline to determine the extent of the mine's liability framework.

A generic environmental legal risk analysis was conducted which focussed on the consequences of identified risks, i.e. the consequences that may stem from non-compliance with key legislative requirements. These can range from penalties and fines, to imprisonment, withdrawal of licences, lawsuits and reputational risk which may individually and/or collectively have a fundamental impact on an organisation's corporate governance at board and business levels. It is noted that penalties for infringement of these licences as well as commencement of activities without the relevant authorisation can include (for a person convicted of an offence) a fine not exceeding R10 million or to imprisonment for a period not exceeding 10 years, or to both such fine and imprisonment; as well as cancellation of permits. The South African Government is becoming very strict in ensuring compliance with environmental legislation.

It is CSA Global's view that to determine compliance in respect of the identified Mining Rights (MM, MM A, WM, WM A) and Prospecting Right HYM, a compliance and performance assessment audit is required. The Hotazel Closure Plan (2014) refers to a number of existing operational licenses for waste disposal (NEMWA), water use (NWA), and air emissions (NEMAQA). Again, to determine compliance risk and liability a compliance audit is required. CSA Global has not conducted such audits as part of this CPR.

BHP Billiton has advised CSA Global that they have a license to operate at Mamatwan Mine and Wessels Mine, and that they comply with the license terms, conditions and legislative requirements.

2.8.2 Health, Safety, Environment and Community

BHP Billiton has a uniform and consistent set of Values and Policies that include: sustainable transformation; zero harm as a safety measure that includes all personnel on site; and proactive risk identification and mitigation, especially of those with potentially high severity.

At Mamatwan Mine this was demonstrated by ensuring that safety statistics include all contractors on site. At Wessels Mine the ventilation shaft was constructed to ensure that employee and contractor exposure to diesel particulates is greatly reduced, better managing health exposure levels.

2.8.3 Social License to Operate and BBBEE

In South Africa, Corporate Social Responsibility (CSR) is not obligatory through the South African Companies Act 61 of 1973, but the country's Policy Document and the King II and King III reports explicitly address the need and relevance for corporations to acknowledge all stakeholders and to adopt a 'triple-bottom line' approach.

The King reports constitute accepted guides of best practice in corporate governance in South Africa, focusing on social, environmental and economic concerns. The King reports' clauses are not mandatory, but they take a 'comply/apply or explain' approach so that corporations apply CSR programs or justify why they have not adopted them.

Not all CSR efforts in South Africa result from voluntary or indirect business decisions; some of them are the product of corporate compliance with the Broad-Based Black Economic Empowerment (BBBEE) legislation. The BBBEE Act forces South African-based companies to consider all stakeholders when performing their internal and external operations in an effort to eradicate social and economic inequalities inherited from the Apartheid days and to help previously discriminated groups to actively participate in the country's economy. Companies that refrain from complying with the BBBEE scorecard can obtain negative ratings, complicating their ability to operate in the country.

Between 2007 and 2009 Samancor entered into several BBBEE transactions to meet its ownership obligations. The initial transaction involved the divestment by Samancor of its Mamatwan and Wessels Mines and the divestment by Ntsembintle of prospecting rights adjacent to Mamatwan and Wessels, to HMM in return for 91% and 9% of the equity in HMM, respectively. In three further transactions, Samancor sold 17% of its shareholding in HMM to NCAB, Iziko and The HMM Education Trust. The acquisition of these shares by NCAB, Iziko and the Trust was funded by Samancor through vendor loans that are repaid via distributions from HMM attributable to these BBBEE entities.

Samancor indirectly owns 74% of HMM, so that currently BHP Billiton has an effective interest of 44.4% The remaining 26% of HMM is owned by the following BBBEE entities:

- Ntsembintle Mining (Pty) Ltd (9%)
- Iziko Mining (Pty) Ltd (5%)
- NCAB Resources (Pty) Ltd (7%)

- The HMM Education Trust (5%).

HMM has been accredited as a Level 3 BBBEE contributor by an independent accredited rating agency in June 2012. This accreditation indicates that the HMM BBBEE program is achievable.

BHP Billiton has a stated commitment in their Code of Business Conduct to both BBBEE and Transformation as a national and a company imperative. This is because it is important for the stability of South Africa and the growth of its economy, and for the company's strategic and sustainable-growth objectives.

The achievement of BHP Billiton's BBBEE and Transformation objectives can be evaluated against the following goals:

- A meaningful increase in the number of Black people, women and people with disabilities who have equity ownership and associated control when opportunities become available.
- A significant increase in the number of Black people, women and people with disabilities in executive, senior management, middle and junior management positions in the South African BHP Billiton Assets.
- Improved access to infrastructure, increased acquisition of skills, and increased participation in productive economic activities in under-developed areas in South Africa where BHP Billiton has an operational activity.
- Accelerated initiatives that build equity and equitable representation of all demographics.
- Increase BHP Billiton -led initiatives in South Africa that will promote business opportunities for Black people, women and people with disabilities through preferential procurement, beneficiation, and enterprise development and facilitate the reduction of income inequalities between and within race and gender groups.

BHP Billiton claims that their progress has improved considerably since 2009 by targeting Transformation for special attention and making Transformation targets part of their leadership's accountability. HMM's BBBEE performance is audited annually by an accredited external verification agency.

BHP Billiton relies on the BHP Billiton Development Trust South Africa to implement, coordinate and manage various sustainable development initiatives in the areas of education and training, capacity building, socio economic development and health care.

Increasing local procurement creates opportunities for local businesses to supply goods and services to them and to others, and to grow and diversify (BECSA Business Support Centre; Ba-Gaphadima Sand Mine Project).

Education has direct benefits for economic participation and health and wellbeing, and improves access to employment and business opportunities in communities. It also increases the pool of technically qualified employees (Hotazel Learner Incubator Program).

Working with stakeholders supports multiple sustainable uses of land. Examples are:

- A farming project aimed at bolstering the economic participation of communities (Surprise Farm)
- Commitment of ZAR 68 million for construction of 8 km of road to mitigate exposure to asbestos dust for one of the host communities of Hotazel in partnership with the Department of Roads and Transport (Tsineng Road). Phase 2 of the project started in 2013 for 28 km of road to connect nine villages.

Healthy communities are productive communities so the health of employee families, friends and the community at large is supported (Early Childhood Development Project; King Edward VIII Hospital and the BHP Billiton Paediatric Centre of Excellence; and the HIV & Me program in partnership with 10 school communities surrounding Hotazel).

2.8.4 Closure Liability

The legal requirements and guidelines that are applicable to closure and rehabilitation planning in South Africa, and to the Hotazel operations, include but are not limited to:

- The Minerals and Petroleum Resources Development Act, Act No. 28 of 2002 (MPRDA)
- Existing operational licenses and tenement conditions
- National Heritage Resources Act (1999)
- Guidelines for the rehabilitation of mined land.

Any mining right application (MRA) to the Department of Mineral Resources (DMR) requires financial provision to conduct rehabilitation of the operation. The assessment of the amount usually occurs during the application phase, and thereafter states the rehabilitation funding and financial provision calculations must be reviewed every year, or every two years, depending on the requirements of the DMR.

Hotazel updates the financial provisions for mine closure on an annual basis. These costs are revised in conjunction with the environmental performance assessment of the EMP for each mine every year, which must be submitted to the DMR.

The principles for mine closure, the requirements for a closure plan and the requirements to apply for a closure certificate are detailed in the Hotazel Closure Plan (2014). The defunct mines Old Hotazel York and Middelpaats do not have current approved EMPs, but updates to the financial provision costs occur with the other operations on a yearly basis. Application for mine closure certificates for the two defunct mines is planned under the MPRDA.

The cost estimation process for financial provision includes all DMR categories:

- Demolition and disposal
- Reshape and re-contour to final drained land-form
- Rehabilitation
- Hazardous waste disposal
- Human resources
- Community rehabilitation
- Pre-closure costs
- Indirect costs
- Post-closure monitoring and management.

To develop a conceptual closure plan and allocate financial provision for closure execution, the preferred final land uses for each of the Hotazel sites was determined in consultation with stakeholders. The final land-use options considered for each site in the latest Hotazel Closure Plan (2014) are:

- Mamatwan Mine - grazing land, game farming land, open space land
- Wessels Mine - grazing land, underground accommodation (prison), open space land
- Old Hotazel York Mine - rezone into residential, open space land, tourism site
- Middelplaats Mine - water retention reservoir, grazing, life-stock farming.

The closure cost models are designed to comply with DMR and corporate requirements. Cost items are revised annually by updating the quantities using survey data and by escalating the rates. Every five years an independent consultant verifies the quantities and updates the costs using market rates. Table 4 shows the financial provision in US\$ from the Hotazel Closure Plan (2014).

Table 4 Closure provisions by Mine

Item	FY14 (US\$ M)	FY13 (US\$ M)	Change (%)
Mamatwan Mine			
Accounting Provision (discounted)	69.8	66.7	5
Economic Provision (discounted)	53.2	62.4	-15
Wessels Mine			
Accounting Provision (discounted)	3.4	3.2	6
Economic Provision (discounted)	4.2	5.0	-16
Middelplaats Mine			
Accounting Provision (discounted)	1.8	1.7	5
Economic Provision (discounted)	0.9	1.1	-18
Old Hotazel York Mine			
Accounting Provision (discounted)	23.2	22.1	5
Economic Provision (discounted)	12.5	14.5	-14

The closure provisions are based on the Closure and Rehabilitation Schedules for each operation which detail the significant infrastructure and when these can be rehabilitated.

CSA Global considers that the process used by Hotazel for developing closure plans, risks and costs is appropriate. CSA Global has not audited these as that would take considerable time and extensive site access.

3 Mamatwan Open Pit Mine

3.1 Regional Geology

South African manganese deposits are currently confined to the Early Proterozoic Transvaal Supergroup, Northern Cape Province. They can be grouped into two major categories:

1. Syngenetic carbonate-rich manganese deposits interbedded with the banded iron formations (BIF) of the Hotazel Formation, colloquially called the Kalahari Manganese Field.
2. Karst-fill type manganiferous material from residual Fe-rich manganese developed in dolomites of the Campbell Rand Subgroup in the Postmasburg Fe-Mn Fields.

The Kalahari Manganese Field is situated within a structural basin, known as the Dimoten Synclinorium, plunging at an angle of 3° to 8° to the north and northwest. It extends from Mamatwan Mine in the south for approximately 40 km to Wessels Mine in the north, with an east-west extent varying between 5 and 15 km (Figure 4).

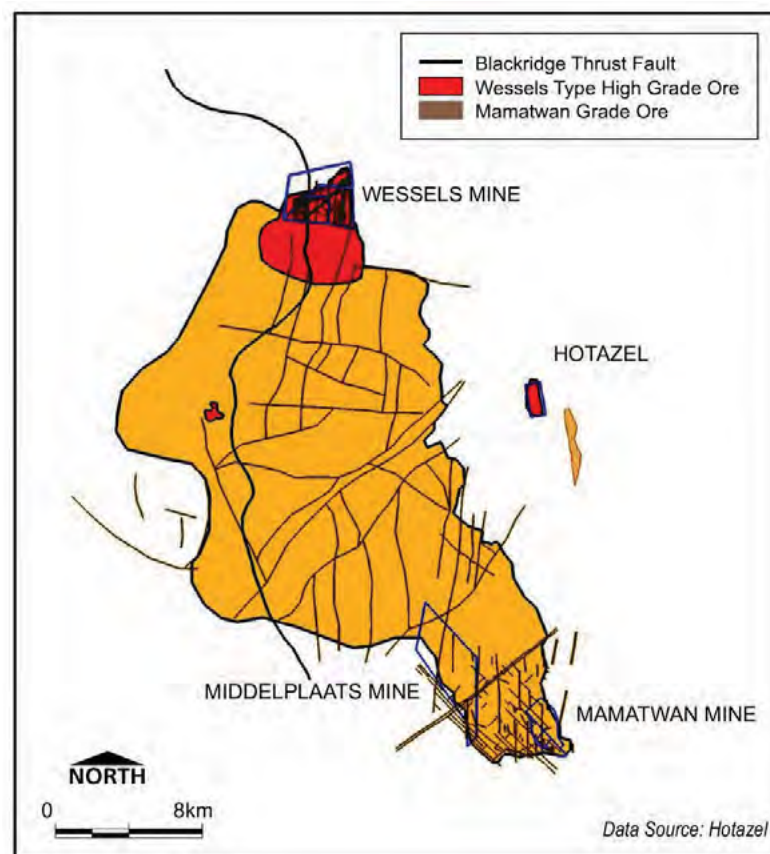

Figure 4 Geological structures and spatial relationship between Mamatwan (SE) and Wessels (N) mines

A summary of the local stratigraphic profile is presented in Figure 5 which shows the Ongeluk, Hotazel and Moidraai Formations in the Kalahari Manganese Field, including an interpretation of their depositional environment (after Beukes, 1983).

	KALAHARI SEDIMENTS	KALAHARI GROUP
	DWYKA TILLITE	KAROO SUPERGROUP
	MAPEDI SHALES & LUCKNOW QUARTZITE	OLIFANTSHOEK GROUP
	OLIFANTSHOEK UNCONFORMITY	
	HOTAZEL FORMATION	POSTMASBURG GROUP
	ONGELUK LAVA	ONGELUK FORMATION

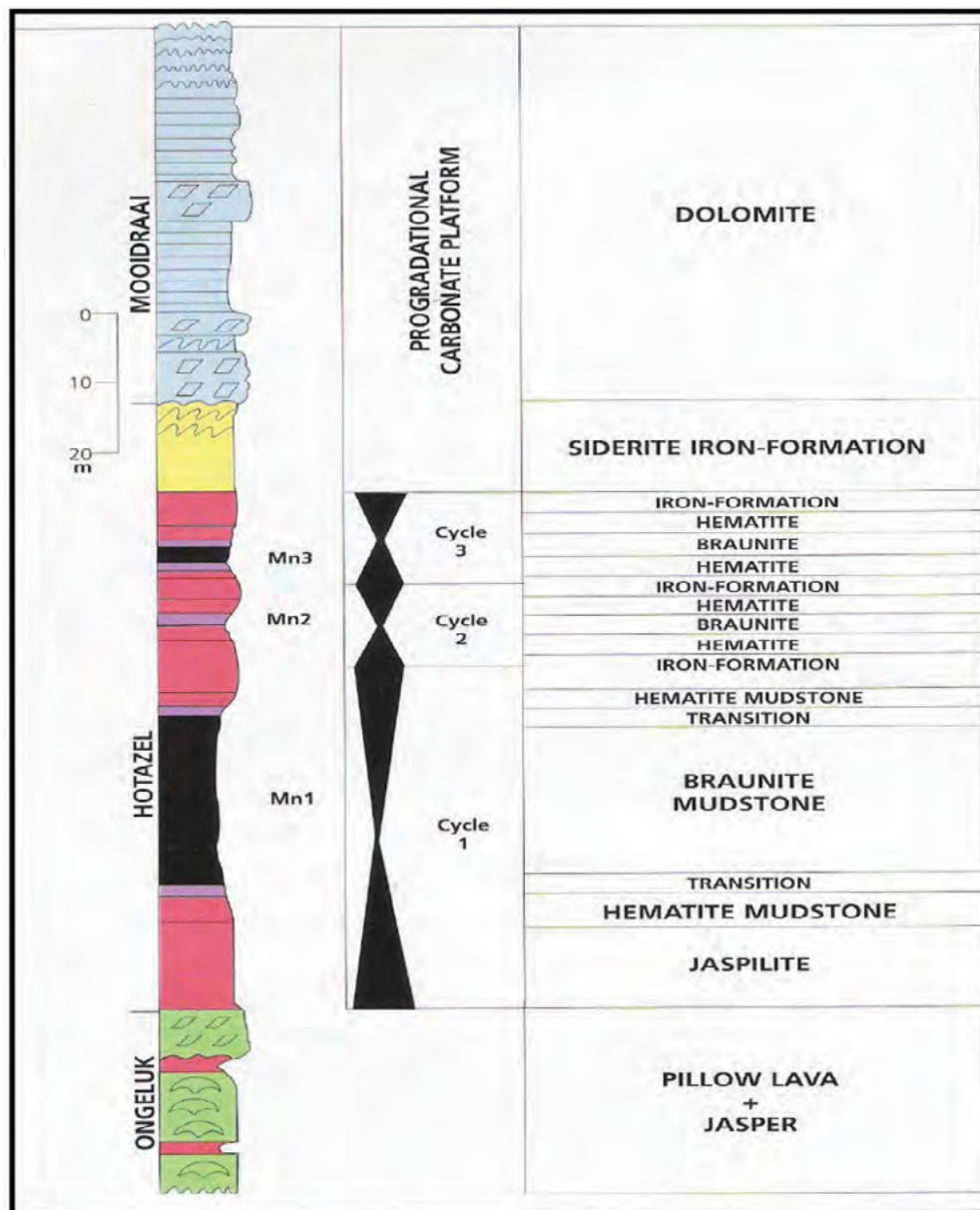

Figure 5 Regional (top) and local (bottom) Mamatwan and Wessels stratigraphic profile
Source: Hotazel

3.2 Local Geology

The manganese mineralisation at Mamatwan is hosted by the Hotazel Formation of the Postmasburg Group (Transvaal Supergroup) and occurs as stratiform bodies interbedded with banded ironstone formation. This Formation is characterized by three manganese-rich horizons, called the Lower, Middle and Upper Bodies respectively, separated by BIF.

The lowermost of the three units, the Lower Body (LB), is the only unit exposed and currently mined at Mamatwan Open Pit Mine. The Middle Body is poorly developed, often ferruginized, and carries no economic value. The Upper Body (UB) is considered to be potentially economic, with manganese scattered throughout the unit. The Kalahari Manganese Field, with specific reference to the Mamatwan type ore (rich in braunite–kutnahorite mineral assemblages) represents approximately 97% of the total manganese resource in the region (see Figure 4).

At Mamatwan Mine the LB is 37.5 m thick on average. It is subdivided into an uneconomic 19.5 m thick upper horizon (the Top Cut) containing $\pm 31\%$ Mn, with a Mn/Fe ratio of 5; a central horizon (the Manganese Cut) which is on average 19.7 m thick and contains $\pm 37.5\%$ Mn with a Mn/Fe ratio of 8.5; and a 6 m thick Basal horizon. These are subdivided into smaller seams (Zones), based on different mineralogical compositions. The Zones are visually distinguishable from each other and are identifiable by a combination of geological logging and chemical analysis. The M, C, and N Zones of the central horizon are high grade while the lower grade material of the Top Cut is represented by the V, W, X, Y and Z Zones. The Basal horizon is low grade and not considered to be potentially economic so is not part of the Mineral Resource. Figure 6 presents a schematic section through the Mamatwan manganese bearing horizons.

The ore at Mamatwan consists of banded, very fine-grained braunite-kutnahorite lutite, containing concretionary ovoids, laminae and lenticles of Mn-calcite with which hausmannite is commonly associated. Subordinate amounts of hematite, jacobsonite and rhodochrosite are also present. The relatively high Mn/Fe ratio of the economic manganese ore makes it suitable for the production of high manganese (76% Mn) alloys. The relatively high carbonate content of the ore, reflected in the CO₂ content of 12 to 16%, makes it virtually self-fluxing.

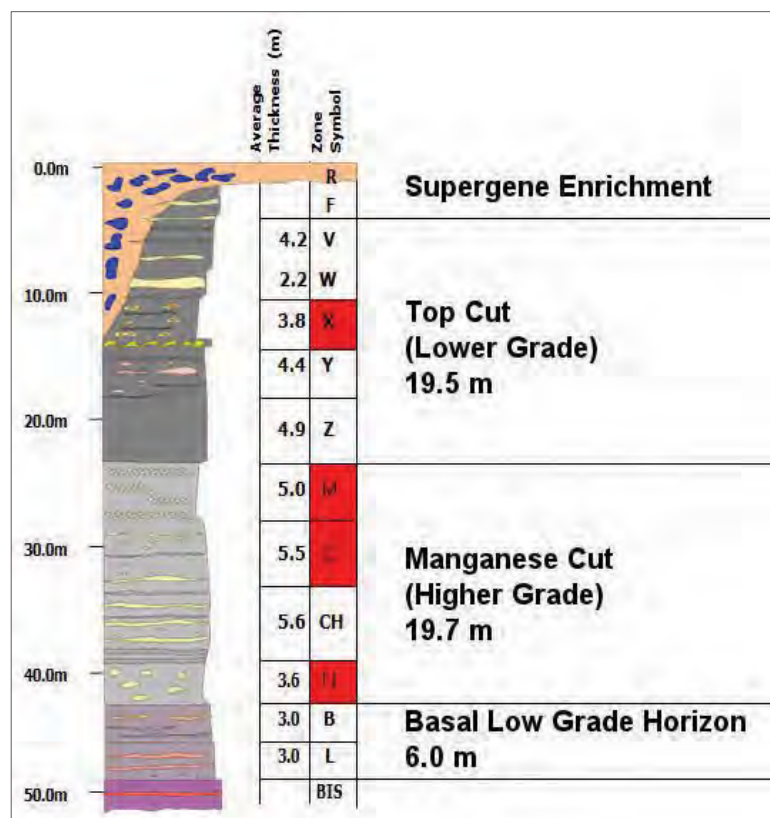

Figure 6 Mamatwan manganese bearing horizons and Zones

This shows the Top Cut (VWXYZ Zones) and the economic Manganese Cut (MCN Zones)

Source: Hotazel

3.3 Mineral Resource Estimation

3.3.1 Drilling, Logging and Sampling

Data used to construct the geological block model and estimate the Mineral Resource (Ferreira *et al*, 2014a) is obtained from surface diamond core drilling and geological mapping. Samples obtained from production blast holes are only used for grade control. A comparison of the data from blast holes with the resource model is provided in Section 3.5.5.

Exploration and development drilling in the Mamatwan Project area started in the early 1960s with first production from the mine in 1964. A summary of the database of drilling used to construct the 2013 block model that was used for the current Mineral Resource estimation is provided in Table 5 and Table 6. All samples were assayed by XRF at the Mamatwan site laboratory for Mn, Fe, SiO₂, Al₂O₃, CaO, MgO, P, S, Na₂O and K₂O. Loss on Ignition (LOI) was determined and Washability was used to define expected yield by recovered weight.

The location of all surface drilling is checked and the lithological and assay information verified by project geologists to ensure consistency in interpretation of the Zones. The majority of surface drilling has delineated both the hangingwall and the footwall of the manganese mineralisation.

All relevant drill hole geology and sample information is stored in the Micromine GeoBank Database. Collar survey data is processed and managed in MicroStation software before transfer to GeoBank.

Data validation of assay data includes: consistency of drill hole numbering; a review to ensure that Mn plus Fe does not exceed 100%; any missing and/or negative grades are checked and the data re-assayed if required; and error detection functions are run in Micromine during merging of assay and lithology intervals to ensure there is no sample duplication or overlap. All errors identified are referred back to the project geologist for correction in the primary database.

During FY13 there were 21 additional diamond drill holes completed to improve confidence in peripheral zones to the west of the Mineral Resource. A total of 17 holes have been drilled since the cut-off date for the 2013 Mineral Resource estimate. The additional holes have improved the resource definition in the deeper parts to the west and northwest of the resource.

Table 5 Summary of the Mamatwan drill hole database at October 2014

Hole group	Drill hole type	Number of drill holes	Used in Mineral Resource estimate
MA	DD	171	171
MPW	DD	2	2
G	DD	477	459
Total		650	632

Table 6 Assays in the Mamatwan drill hole database by Zone at October 2014

Unit group	Zone Code	Metres assayed	Count of samples	Metres used for MRE	Count of samples used for MRE
M, C, N Zones	M	3,711.5	3,669	3,642.3	3,594
	C	3,634.3	3,465	3,464.5	3,325
	N	1,919.0	1,858	1,868.5	1,803
X Zone	X	1,108.7	1,074	1,027.0	987
Top Cut Zone	V	1,109.4	996	1,061.0	937
	W	1,421.3	1,322	1,381.1	1,273
	Y	3,433.4	3,090	3,270.4	2,931
	Z	1,905.7	1,843	1,853.7	1,781
Total for Mn units		18,243.2	17,317	17,568.4	16,631
Total for non-Mn units		33,812.4	8,287	32,113.8	7,910
Total metres sampled		52,055.6	25,604	49,682.2	24,541
Total metres drilled		52,688.1			

A total of 18 drill holes (mainly historical) were not used for the following reasons:

- missing assay values
- incorrect lithological boundary demarcation
- missing data within the historical drill hole log
- co-ordinate verification errors.

A further 10 holes were excluded from the model as they intersected faults and hydrothermal veins. These holes were used for the geological interpretation but not the resource estimation.

The economic manganese is contained in the seams called the M, C and N Zones (MCN).

The diamond holes are drilled vertically and downhole surveys are not done due to the relatively shallow depth of drilling (average 80 m, 20th percentile 64 m and 80th percentile 94 m).

All drilling is carried out by external contractors, using BHP Billiton standards and protocols. The average drill core recovery at Mamatwan Mine is 95%. Recovery is a key component in the contractual agreement with the drilling contractor.

A plan view of the Mamatwan drill hole collars is presented in Figure 7. Drill holes used in the June 2013 Mineral Resource estimate are coloured green and those drill holes not used are coloured red. Generally the drill holes not used were drilled or sampled after the effective date of the June 2013 Mineral Resource estimate. The black outline is the pit perimeter at surface elevation (average 1,093 m above sea level) at June 2013.

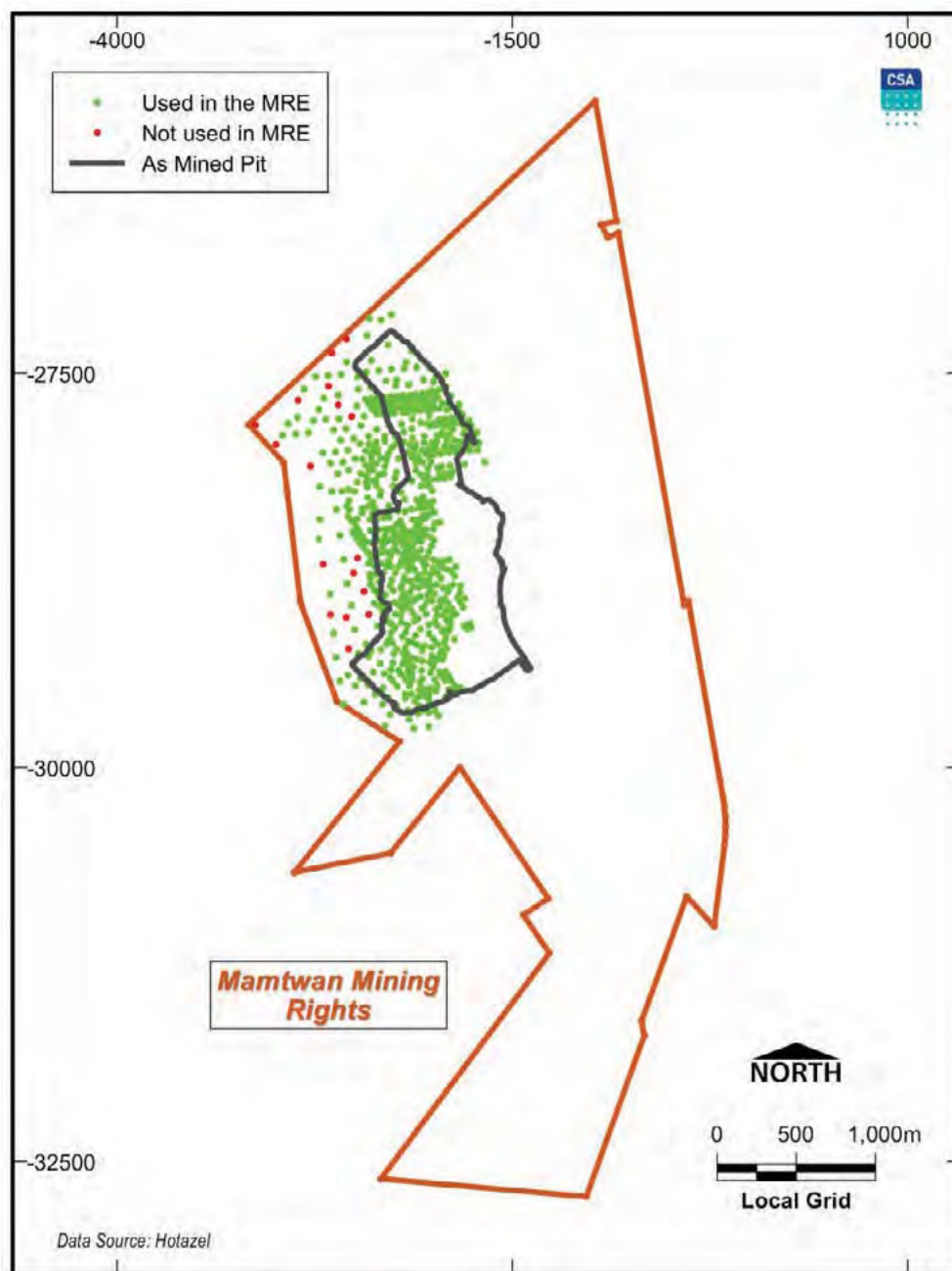

Figure 7 Plan view of drill holes used in the Mineral Resource estimate

The nominal sampling interval for diamond core is 1 m. Sample intervals are based on lithological boundaries, so can be less than or greater than 1 m depending on individual seam thickness. A review of sampling interval lengths for the M, C and N Zones shows a median and mean length of 1 m with the 10th percentile at 0.7 m and 90th percentile at 1.4 m.

All core to be sampled is split with a diamond saw, with one half sent for chemical and physical analysis, and the other stored for future reference. All sample preparation, including crushing and pulverizing, is done on site with the pulps being sent to the Mamatwan site laboratory for analysis. All recent surface drill hole core is stored in the centrally located core yard at Hotazel.

A number of historical underground drill holes (pre 1990) are not verifiable due to a policy at that time, since discontinued, not to retain core. Ongoing renovation and increase in capacity of the core yard means that all retained core is now accessible.

Physical washability tests are completed and used to optimise the dense media separation (DMS) plant settings in order gain maximum product yield, while LOI results are used in predicting ore sintering qualities.

The XRF assay results are directly fed to the geology database using a Laboratory Information Management System (LIMS).

Random duplicate samples (an average of 1 in 5 for the manganese Zones) are generated and submitted to the laboratory as part of the Quality Assurance and Quality Control (QAQC) requirements. Regular round robins with other independent laboratories are performed to ensure in-house accuracy. The Hotazel laboratories comply to ISO 9001 standards and the Mamatwan laboratory is completing the process to acquire ISO 17025 accreditation. Analytical ISO standards are employed in the determination of both Mn and Fe. Quality is maintained using samples of SARM17 (Mamatwan type), a certified reference material from Mintek for the determination of manganese grade. Quality reports are completed daily at the laboratory, showing all standards and results within the laboratory, including additional duplicates.

During FY14 new procedures which included introduction of certified reference standards were introduced to improve the QAQC process for Mamatwan. In addition, the laboratory runs an independent QAQC process. Generally the laboratory is able to reproduce the certified value to within 3 standard deviations although some outliers do occur. The new procedures address how these outliers should be managed when making decisions regarding the validity of each assay batch.

CSA Global Assessment

The sampling procedure was examined by CSA Global and was considered acceptable for the purpose of Mineral Resource estimation. Duplicate assay results indicate that the sampling protocols adopted for the sampling and assaying of the core are valid and appropriate.

It is CSA Global's opinion that any potential minor downhole survey deviations will not have any material effect on the Mineral Resource estimate as the manganese bearing horizons (Zones) are near horizontal, continuous and mined as a bulk commodity with closely spaced blast hole sampling and visual ore control during mining.

Blanks and quartz flush are not used in the sample preparation stage. It is arguable that the bulk commodity nature of manganese sample preparation may not require this Quality Assurance procedure but Hotazel has decided to implement it going forwards.

Plots showing pulverising efficiency data for the Mamatwan laboratory have been reviewed by CSA Global and demonstrate appropriate pulverising of samples in preparation for chemical analysis. The quality of pulverising was previously noted as an issue in the Snowden audit completed in 2012.

Review of duplicate assay results, certified reference material assays and pulverisation size fractions indicate that the protocols adopted for the sampling and assaying are valid and appropriate for Mineral Resource estimation.

3.3.2 Geological Interpretation

The manganese mineralised seams contain recognisable internal facies differences, identifiable on the macroscopic scale and distinguishable by a combination of geological logging and chemical analysis. The zone of manganese mineralisation is subdivided into the V, W, X, Y, Z, M, C, N, B, L and I Zones and drill core is logged accordingly. In-pit mapping of joints, faults and fissures uses survey controls to update the grade control model on a monthly basis. Faults in the pit are considered as 'soft boundaries' for estimation purposes as the minor displacements do not control grade domains.

Wireframes defining the surface of each of the manganese and other lithology seams were constructed from the drill hole logging data and truncated by the mineral lease boundary. Automation to model the seam surfaces through the use of LeapFrog implicit modelling software was investigated during FY13. This allows for quicker, reliable and more regular updates of the geological seam boundaries and the procedures are now being implemented. However, the current FY14 CP statement is based on updates of the FY13 model.

The accurate prediction of small-scale geological discontinuities (primarily the presence of sulphide-rich fissures) and local changes in Mn grade are managed daily during production mining using the close spaced blast hole samples and visual grade control data.

A plan of the drilling data and interpreted Mn seams is presented in Figure 8 showing the location of three west-east cross sections (Figure 9 to Figure 11).

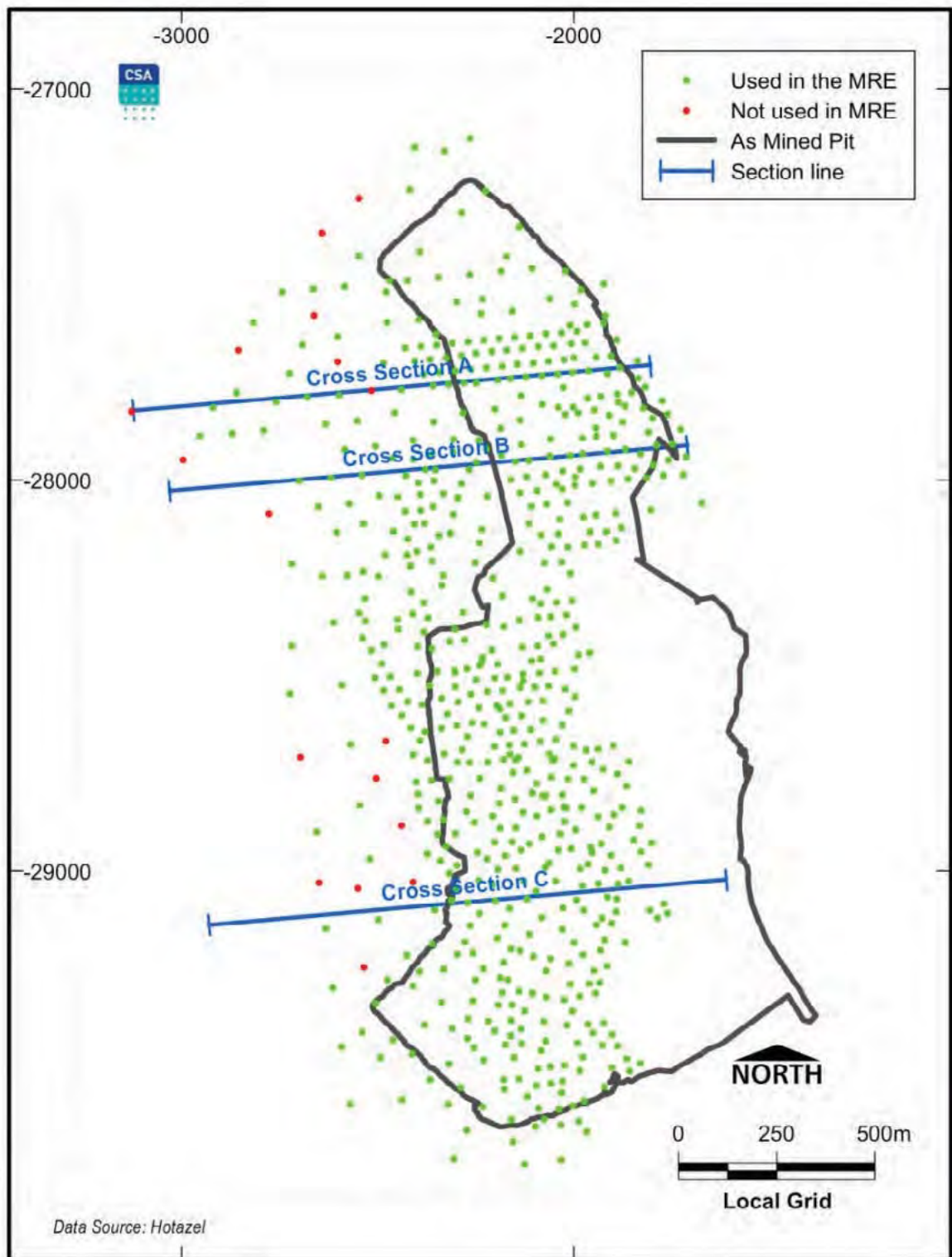

Figure 8 Plan view of drill hole collars in Mamatwan Mine
Blue lines locate the cross section lines in the following three Figures

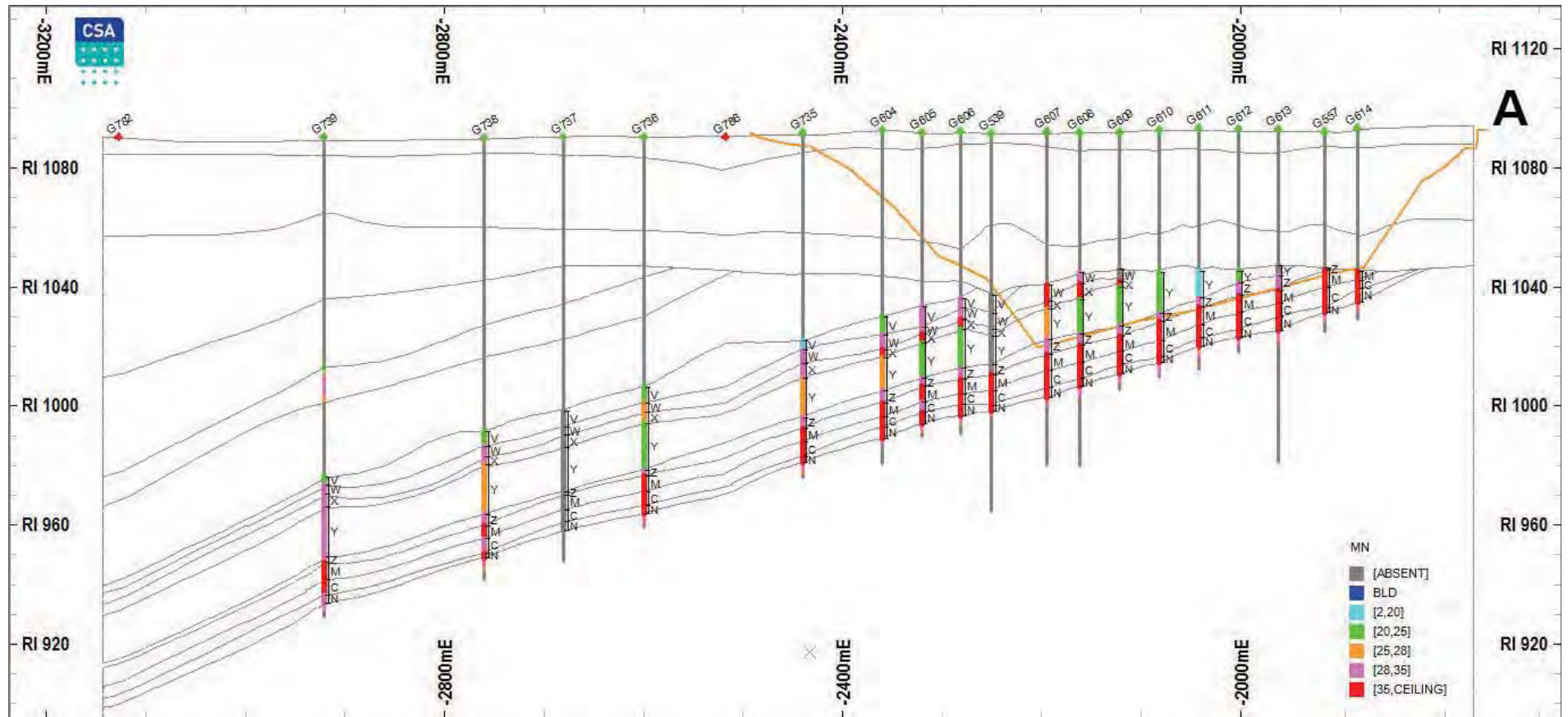

Figure 9 Cross section A facing north centred on -27,850N -2,400E
Shows pit profile and Zones (vertical exaggeration x3)
Data Source: Hotazel

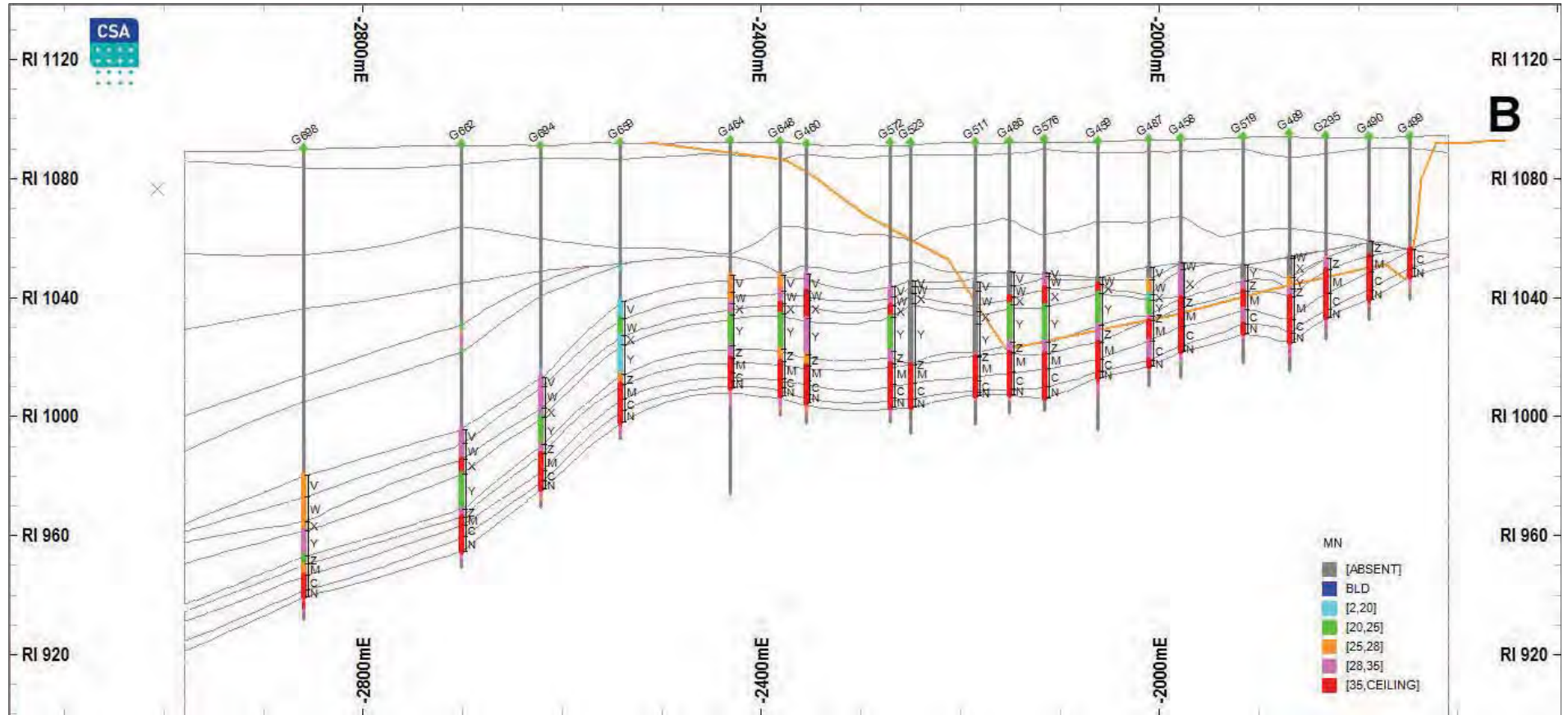

Figure 10 Cross section B facing north centred on -27,965N -2,365E
Shows pit profile and Zones (vertical exaggeration x3)
Data Source: Hotazel

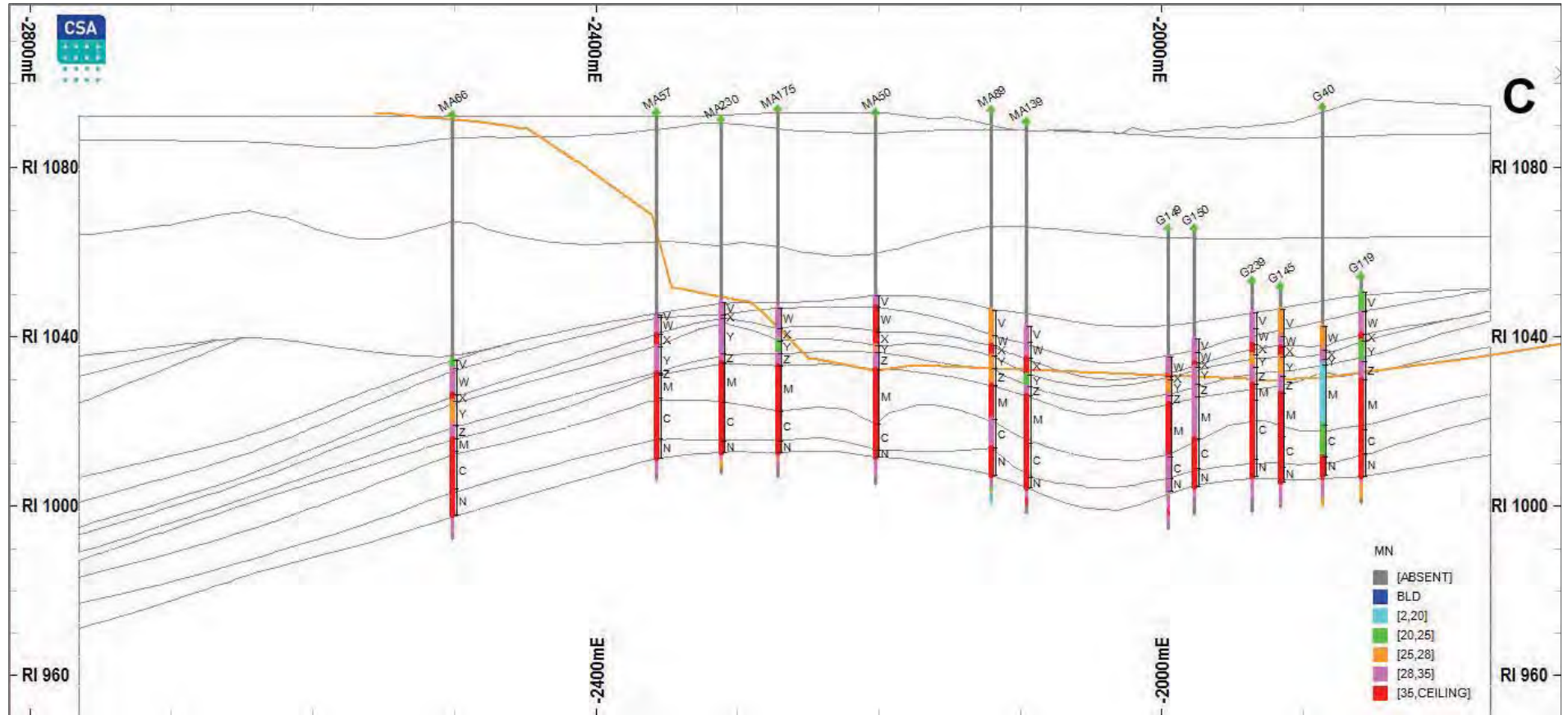

Figure 11 Cross section C facing north centred on -29,080N -2,240E
Shows pit profile and Zones (vertical exaggeration x3)
Data Source: Hotazel

3.3.3 Geostatistical Analysis and Estimation

Statistical analysis was completed for all manganese bearing seams, and for the chemical and physical variables within each seam. Each seam is considered lithologically unique with distinct geological and grade characteristics, hence it is appropriate that each seam is analysed and estimated independently of the surrounding seams. This practice is commonly referred to as 'hard boundary' grade estimation.

The grade populations for Mn generally approximate normal population distributions averaging between 30 and 37% Mn with a slight negative skew related to small populations of lower grade below 25% Mn. The Fe grade population averages between 4 and 6% Fe, with a moderate positive skew related to a small population greater than 7% Fe. A summary of the seam statistics with comments on the sample distributions is presented in Table 7. There are a number of high value outliers within the minor element statistics that will be reviewed to prevent local bias if grades for these are to be estimated in future.

Table 7 Summary of drill hole sample statistics for all Mn seams used in the Mineral Resource estimate

Variable	Mean	10 th percentile	90 th percentile	CSA Global comments
Mn	33.6	23.7	40.5	Good normal distribution, negatively skewed <15% Mn. Seam Y has lowest grade (25% Mn).
Fe	5.20	3.70	7.30	Normal distribution, positively skewed >15% Fe. Seam V has highest Fe grade at 8.6%.
SiO ₂	4.16	2.88	5.50	All Mn seams have very similar grade.
Al ₂ O ₃	0.17	0.12	0.21	All Mn seams have very similar grade. Some significant high grade outliers.
CaO	18.6	10.9	26.7	MCN lowest grade, Seam Y highest grade.
MgO	1.68	1.12	2.11	All Mn seams have very similar grade.
P	0.01	0.01	0.01	All Mn seams have very similar grade. Some significant high grade outliers are present
S	0.05	0.01	0.03	All Mn seams have very similar grade. Some significant high grade outliers.
Na ₂ O	22.7	15.0	28.9	All Mn seams have very similar grade, except for Y and V seams which are higher grade.
K ₂ O	1.22	1.00	2.00	All very low grade.
LOI	19.9	15.7	24.6	All Mn seams have very similar grade. Some significant high grade outliers.
Washability	36.7	8.0	65.5	Significant variability within seams. Seams M, C and N have highest variance.

A block model was constructed to honour the Mn seam wireframe volumes based on the criteria presented in Table 8.

Table 8 Block model parameters

Block model parameters	X	Y	Z
Parent block size (m)	10	10	1,000
Subcell size (m)	10	10	Unit seam height
Block model minimum (Local Grid)	-3,166	-29,814	888
Block model maximum (Local Grid)	-1,666	-26,914	1,888
Total parent blocks	150	290	1

Spatial statistical analysis through examination and modelling of variograms for each Mn seam was completed to derive appropriate parameters for grade estimation using Ordinary Kriging. An example of a Mn variogram for seam C is presented in Figure 12. The nugget values for Mn ranged from 3 to 32% for the various seams. The variability of the nugget values has been noted and will be investigated as part of the next Mineral Resource update. The majority of variograms for Mn, Fe and CaO were modelled using a double spherical model. The first range at around 80 m comprises 30 to 70% of the population variation. The total range varies from 275 to 550 m.

The search neighbourhood used for estimation of grade into the model blocks was as follows:

1. Spherical search radius used due to lack of directional anisotropy within the plane of each Mn seam.
2. First search range of 80 m with a minimum of 4 samples required to estimate the block grade. A maximum of 4 samples per sector was allowed with a total of 8 sectors, resulting in a maximum of 32 samples.
3. Second pass range of either 160 or 320 m depending on drill density for the specific Mn seam. The number of samples required was identical to that specified for the first search pass.
4. Third pass range was variable and defined to ensure all remaining blocks were estimated. A minimum of 1 sample was required with the same sample maximum criteria as for the previous search passes.

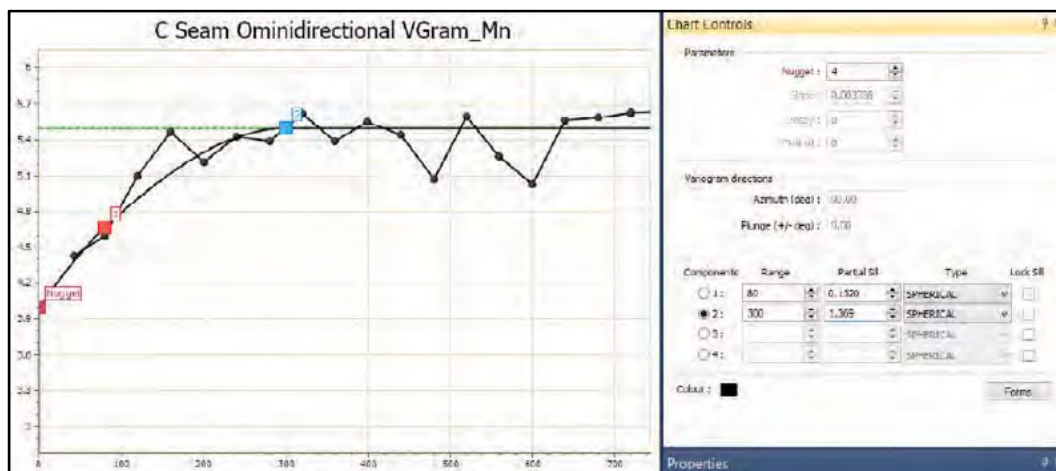

Figure 12 Example of Mn variogram for seam C
Source: Hotazel

Grade estimation parameters were verified by model validation which included: a visual check of drill hole composite grades and block grades; a statistical comparison of declustered sample grades against block model grades; and graphical swath plots comparing grade trends by grid increment within each Mn seam.

The Mineral Resource tonnage was estimated by multiplication of the volume of material above 35% Mn for the MCN and X Zones, and above 28% Mn for the balance of the Top Cut seams, by an *in situ* dry bulk density factor for each seam, as follows (t/m³): V Zone 3.28; W Zone 3.36; X Zone 3.55; Y Zone 3.22; Z Zone 3.46; M Zone 3.69; C Zone 3.60 and N Zone 3.63. The density data was obtained from analysis of representative drill core using the water immersion method with Snowrex scales.

A comparison of the data from blast holes with the resource model is provided in Section 3.5.5.

CSA Global Assessment

CSA Global has reviewed the results of the geological interpretation, sample statistical analysis and grade estimation used to construct the Mamatwan Mineral Resource model. CSA Global considers that the Mineral Resource model reflects both the geology boundaries and grade distribution defined by the drill hole sampling and geological logging.

3.3.4 Mineral Resource Classification and Statement

The Mineral Resources were classified after taking into account the guidelines specified in the JORC Code (2012) for reporting Mineral Resources. Factors considered in the classification are: geological controls and continuity of the manganese seams; internal grade variability of Mn and Fe and the predictability of contaminant grades; quality and spacing of the drill hole sampling, assaying and geological logging; consideration of physical properties such as LOI and Washability; appropriate bulk density and moisture sampling to determine the tonnage factors; and potential for the economic viability of the Mineral Resource estimate. Table 9 shows the Mineral Resource classification.

Table 9 Criteria used to classify the Mamatwan Mineral Resource estimate

JORC Code (2012) Classification	Drill spacing
Measured	Drill grid ≤ 80m, blocks estimated within first variogram range, spherical model.
Indicated	Drill grid ≤ 160m, blocks estimated within total range of variogram model.
Inferred	Drill grid ≤ 320m

A 3D view facing north is presented in Figure 13, showing the higher grade MCN Zones coloured by Mineral Resource classification with drill holes shown in red and the June 2014 open pit shown in beige.

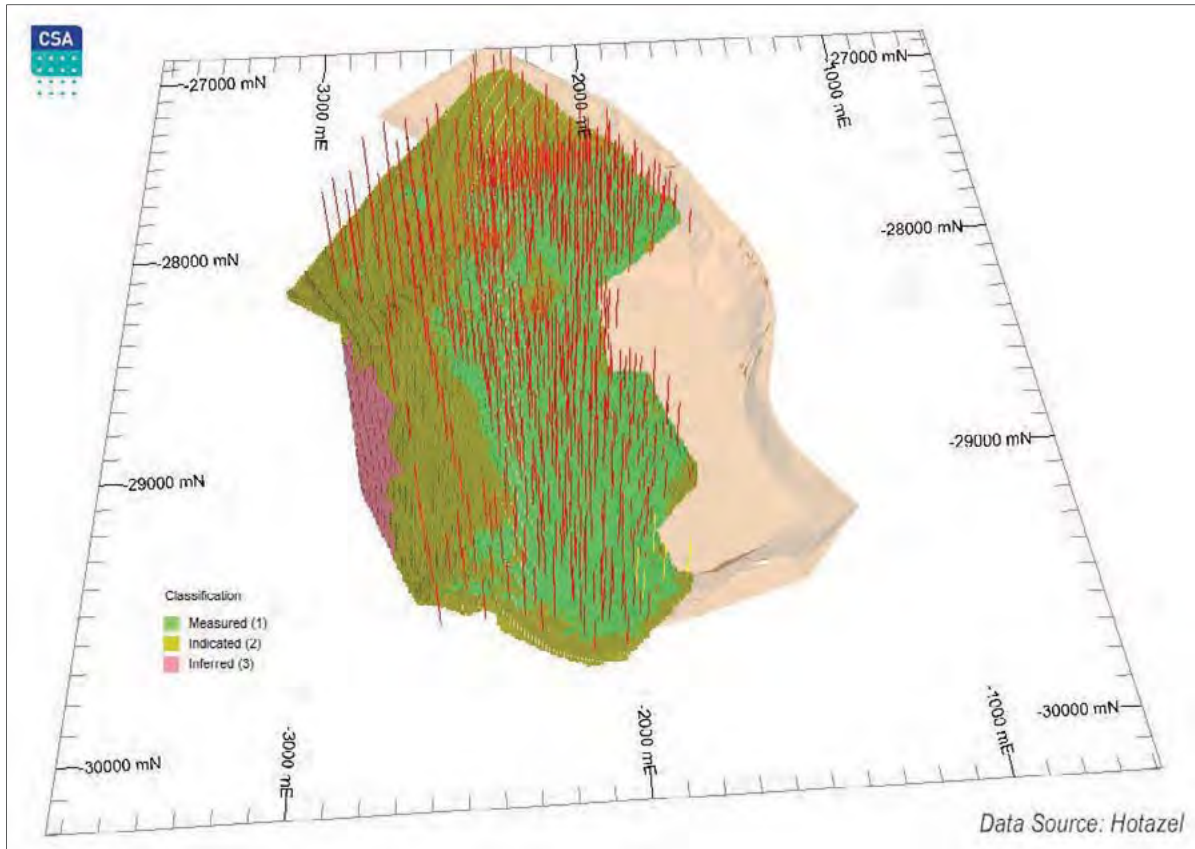

Figure 13 3D view of the MCN Zones coloured by Mineral Resource classification

CSA Global Assessment

CSA Global has carried out appropriate validations of the Mineral Resources estimated by Hotazel for Mamatwan and accepts it as appropriate for the purpose of public reporting under the JORC Code (2012). The methods used for data collection, validation, statistical analysis, grade estimation and classification are considered reasonable and the results are consistent with the data and in line with checks carried out by CSA Global.

CSA Global identified a number of issues with regard to the database, methodology and audit trail which could be enhanced for future Mineral Resource reporting but which are not considered to materially impact on the estimates.

CSA Global has validated and accepts the Mineral Resource estimate for Mamatwan at 30 June 2014 as provided in Table 10. This was estimated at a cut-off grade of 35% Mn, is inclusive of Ore Reserves, and includes material defined in the Top Cut that may not become Ore Reserves (see Section 3.5.8).

Table 10 Mamatwan Mineral Resources at 30 June, 2014

Mineral Resource	Tonnes (Wet Mt)	Mn (%)	Fe (%)
Measured	30.4	35.6	5.1
Indicated	69.6	35.1	5.0
Total Measured + Indicated	100.0	35.3	5.0
Inferred	11.1	33.2	5.5
Total Mineral Resource	111.1	35.0	5.1

CSA Global has determined the depleted Mineral Resource for Mamatwan at 31 December 2014 by deducting actual production to 30 September and forecast production to 31 December 2014 to be as provided in Table 11. This is at a cut-off grade of 35% Mn, is inclusive of Ore Reserves, and includes material defined in the Top Cut that may not become Ore Reserves (see Section 3.5.8).

Table 11 Mamatwan Mineral Resources depleted to 31 December, 2014

Mineral Resource	Tonnes (Wet Mt)	Mn (%)	Fe (%)
Measured	28.5	35.5	5.1
Indicated	69.6	35.1	5.0
Total Measured + Indicated	98.1	35.2	5.0
Inferred	11.1	33.2	5.5
Total Mineral Resource	109.2	35.0	5.1

3.4 Mining

The Mamatwan open pit has been operational since 1964. A primary crusher with a capacity of 650 tph within the pit reduces ore to less than 150 mm. The crushed ore is conveyed over a distance of 1.8 km to the primary stockpile. Various waste dumps, low grade stockpiles and product stockpiles exist.

The Mamatwan mined ore is fed to the Ore Processing Plant (OPP) for size reduction and screening. The crushed and screened ore from the OPP is sold, with a portion of it beneficiated before dispatch for sale. The processing facilities include a dense media separation plant (DMS) and a sinter plant. There is a dedicated railway siding with a conventional loading station. Mining and processing related offices are situated on site. Figure 14 shows the pit and general layout indicating stockpiles and dumps.

3.4.1 Mining Method and Equipment

Mamatwan Mine is located on the southern extremity of the Kalahari Manganese Field. The targeted manganese horizon is the LB. It is a stratiform deposit that dips at $\pm 7^\circ$ towards the west with an average depth of 80 m across the mining lease. The mining method is a conventional open pit operation with drilling, blasting, mining with excavators or loaders and hauling with rigid-frame dump trucks. This process starts with the removal of overburden to uncover the manganese ore and ends with the backfilling of overburden waste material into the exposed pit.

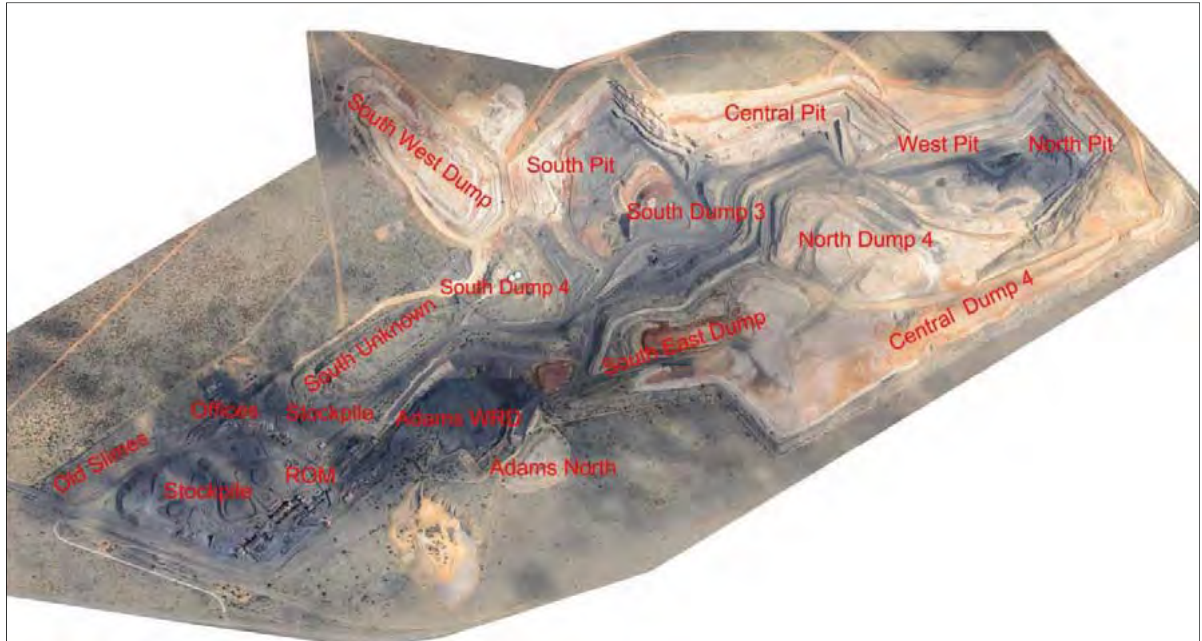

Figure 14 Mamatwan mine layout, aerial view facing northwest

Source: Hotazel

The top layer of unconsolidated sand is removed through free digging to expose the hard overburden. The overburden waste is drilled and blasted, generally in three cuts for the limestone and banded ironstone (where present). The removal of the overburden is done in narrow cutbacks of 60 to 90 m wide to expose the ore on the pit floor. These increase the efficiency of the operation by delaying the stripping of large waste volumes and provide sufficient exposed ore on a just-in-time basis. Each new cutback starts with the Kalahari lithologies and clay at the top.

The top section of the LB is considered to be uneconomic at Mamatwan and is referred to as the Top Cut. This underlies the overburden, and below it is the economic manganese ore. The Top Cut is currently drilled and blasted in a single pass but this might change in the near future once the economic X Zone is exposed. The Top Cut has historically been rolled over into the pit as backfill waste. The FY15 Life of Asset (LoA) plan includes the X Zone part of the Top Cut, where it exceeds a cut-off grade of 35% Mn and a minimum thickness of 3 m. To enable the practical accessibility of the X Zone, an additional working bench would have to be established. That means additional waste stripping to lower the overall operating slope angle and expose the X Zone for mining (Figure 15).

The economic manganese (the Manganese Cut) is currently focussed on the M, C and N Zones in the LB as shown in Figure 15. Due to the relatively shallow depth and thickness of the economic part of the LB, the economic limits of open pit mining extend to the mining right lease boundary. A cut-off grade of 35% Mn is applied to produce a ROM product at an average grade of 37.5% Mn.

A thick layer of clay material exists in the southern section of the pit and thins out towards the north. Where the thick clay layer exists the final pit slope angle and the operating slope angle are adjusted based on geotechnical and safety requirements.

Waste benches are loaded and hauled to permanent waste dumps or backfilled into the pit. The economic LB is drilled and blasted in a single bench. All drilling is carried out by drilling contractors, using track mounted percussion drills that drill blast holes dipping at 70°. A schematic of the operating pit slope is shown in Figure 15.

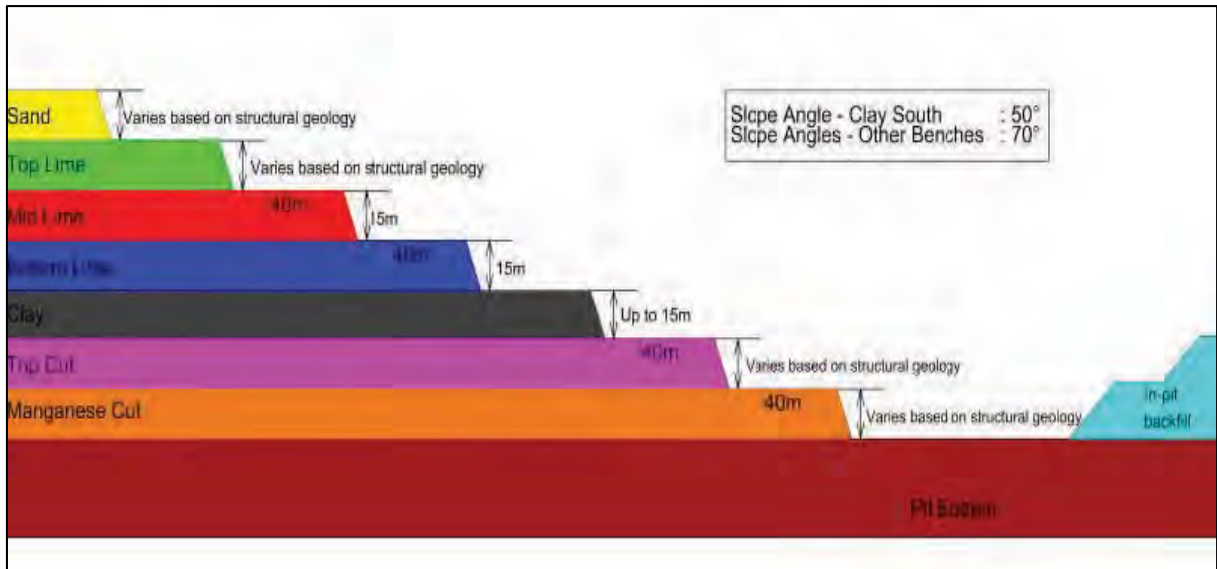

Figure 15 Schematic section through the pit, indicating cuts and thicknesses

Source: Hotazel

Loading of waste and ore is carried out by front end loaders (FELs) and excavators. Table 12 shows the existing mobile equipment fleet at Mamatwan Mine.

Table 12 Mamatwan major equipment fleet

Description	Quantity	Type
Haulers - pit	10	CAT 777D
Haulers - ROM	3	CAT 777F
Front end loaders - FEL	2	CAT 992 g
Excavators - pit	2	CAT 6030
Excavators - ROM	1	CAT 6018
Graders	2	CAT 24 m and 16H
Water trucks	1	CAT 777F
Dozers - track	3	CAT D10
Dozers - tyre	1	834H
Drill rig	4	Atlas Copco ROC L8

One of the initiatives recently implemented was to change the mining direction so that it now proceeds from south to north. The benefits of this are:

- A focussed cutback strategy is enforced that simplifies the operation.
- Stripping ratios are managed effectively to prevent peaks in waste stripping requirements.
- The ability to blend is increased and the requirement to blend is decreased, by making the mining direction parallel to the direction of grade and thickness continuity (in this case the strike of the seams).

The established mining-face configuration is shown in Figure 16.



Figure 16 Mining face layout
Source: CSA Global

3.4.2 Mine Infrastructure and Development

The ROM profile is expected to ramp-up to a steady state production of 3.8 Mtpa in FY22. The relocation of the current in-pit crusher is planned for FY25. This plan will be reassessed based on constraints recently identified by site due to the limited space available for additional infrastructure, waste dumps and stockpiles. Figure 14 shows the relative locations of some of the in-pit waste dumps and crusher.



Figure 17 Mamatwan in-pit crusher and backfill
Source: CSA Global

3.4.3 Rock Mechanics and Dumping

Figure 18 shows a typical geotechnical waste dump design with the angle of repose at 40 degrees and 20 m high lifts giving an overall slope angle of 27 degrees.

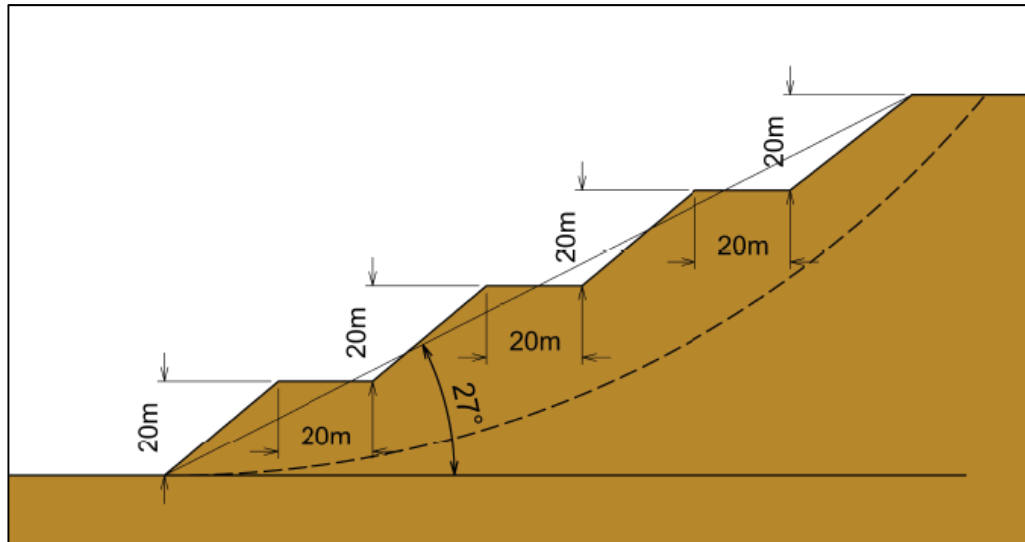

Figure 18 Typical waste dump geotechnical design

Source: Hotazel

Waste movement is a major cost driver at Mamatwan open pit. The constrained pit configuration compounds the requirement to effectively manage the complex waste dumping requirements and this impacts on haulage distances, costs and the ability to maintain ROM stockpiles for X Zone and the remaining Top Cut.

3.4.4 Water

Natural groundwater levels are below the current mining depth, resulting in a generally dry mine. The only exception is the tendency of the calcrete layers to hold water during the rainy season causing slippery road conditions. It is uncommon to encounter water at the mining face, but water does tend to accumulate in the blast holes drilled ahead of mining. Limited seepage within and below the clay layers has been observed, but at low enough levels not to affect the stability of the high walls.

Potable water requirements for Mamatwan are covered by a contract with Sedibeng water, and rely on the de-watering activities of the surrounding iron ore mines. Water is not recovered from the tailings dams, except during exceptionally heavy rain when it is returned to the plant.

3.4.5 Tailings

At Mamatwan the tailings storage facility is constructed in a mined-out pit, considered to be a stable containment area. Tailings are tipped from a conveyer belt and the advancing face is dozed to create an even surface.

3.5 Ore Reserves

3.5.1 Processing

The operation is a producing mine that has been mining, beneficiating and selling product for a considerable period of time. Given that there is no expected change in the ore types or the beneficiation plant, the best indication of the future performance of the operation in upgrading the mined ore to saleable product is the historical performance of the plant. Mineral processing, metallurgy and geometallurgy are not further considered as there is no evidence of changes that would impact on the Ore Reserves as Modifying Factors affecting the processing of the manganese ore.

The crushed ore is conveyed to the beneficiation plant to produce Lump product (40 to 75 mm), Kawasaki product (6 to 40 mm) and Fines product (1 to 6 mm) in two parallel circuits with cone crushers and double-deck sizing screens. The sized ore is stockpiled and blended to product specifications.

The DMS plant upgrades the ore prior to sintering. During the sintering process the ore is calcined and partially reduced. The sinter is stockpiled, blended, reclaimed and railed to Metalloys and other customers. The sintered product is both physically strong and chemically stable, and is the preferred feedstock for ferro-alloy production.

Figure 19 illustrates the flow of material through the Mamatwan processing facilities.

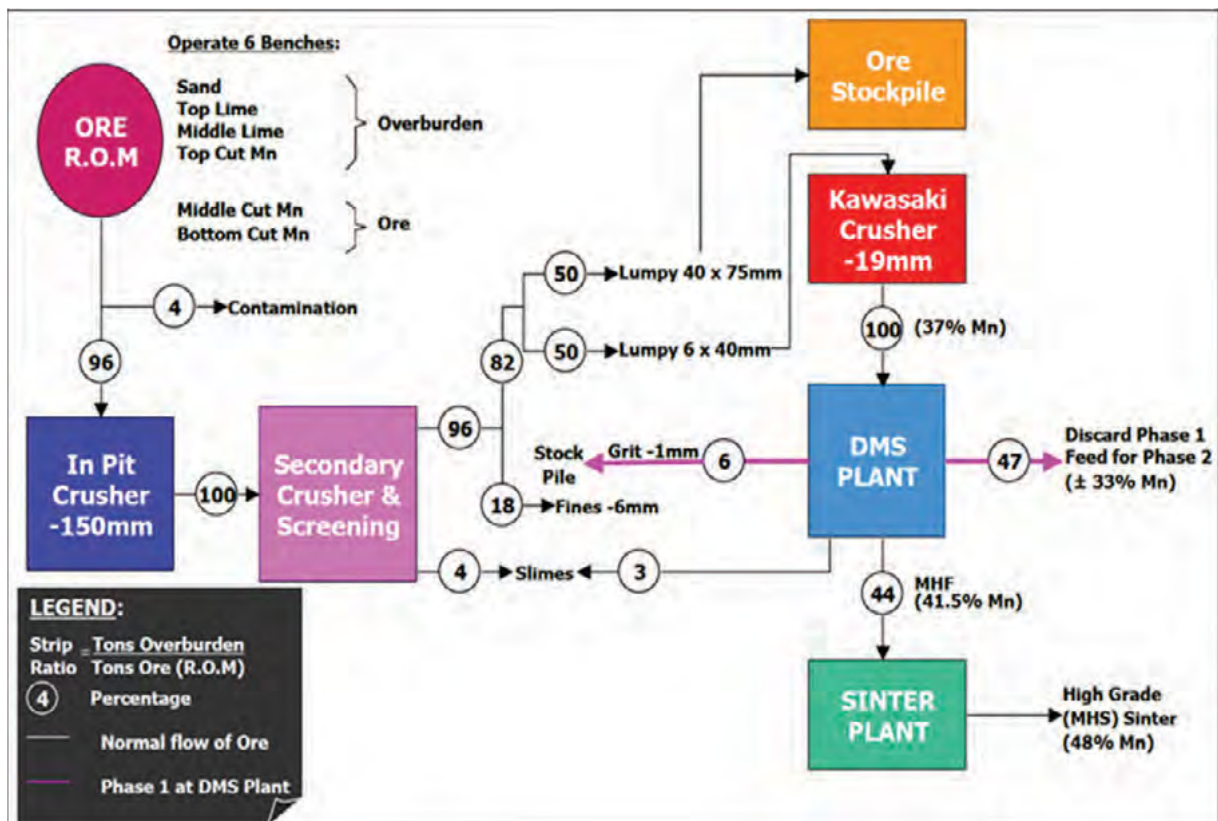

Figure 19 Mamatwan process flow sheet
Source: Hotazel

3.5.2 Life of Asset

A graphic representation of the mining schedule can be seen in Figure 20. The mining direction is towards the north and then from FY26 it advances west to the end of the mine life.

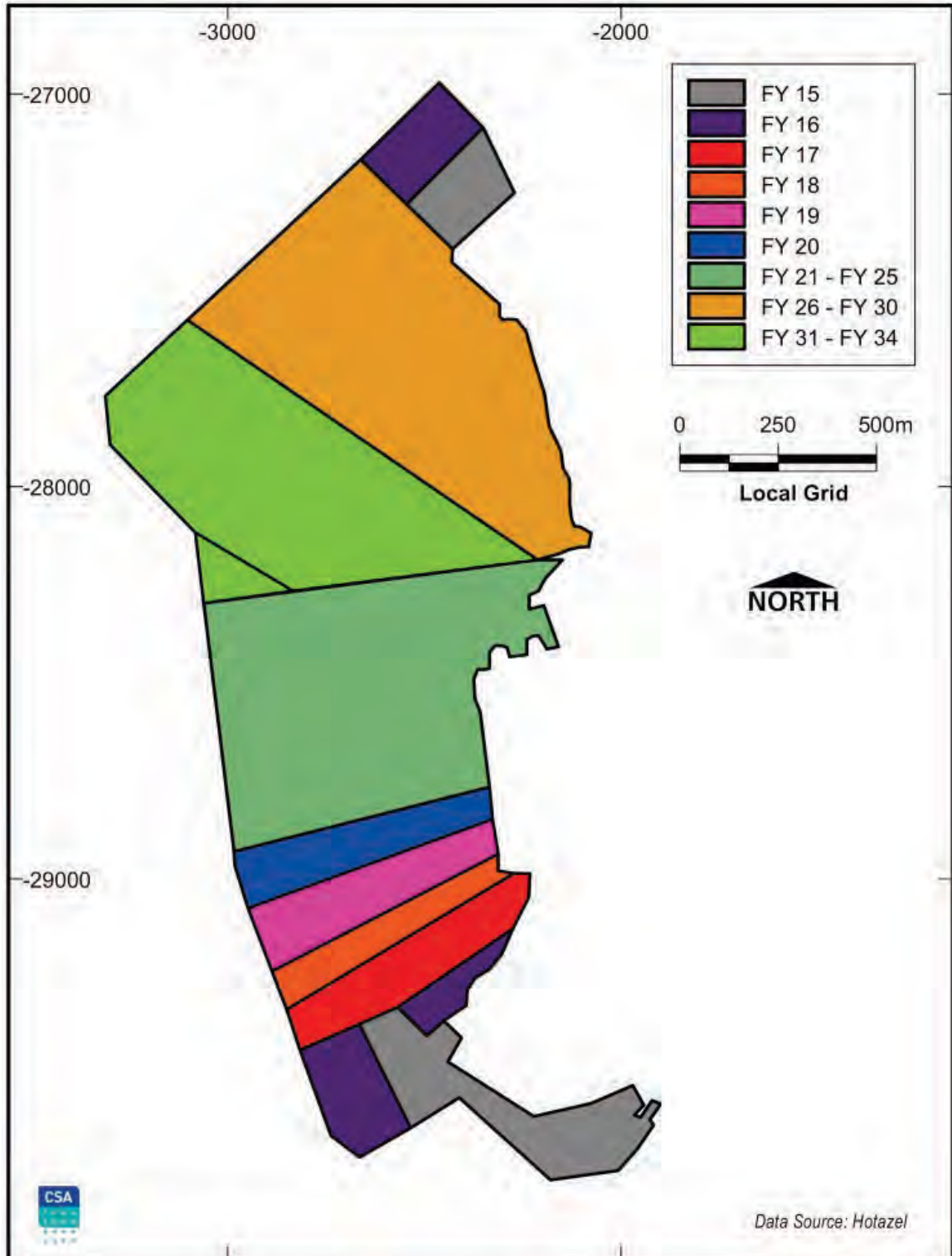

Figure 20 Mining schedule showing annual plan increments

The current production target is 3.5 Mtpa. A ramp-up is envisaged in FY21 to achieve ROM ore of 3.8 Mtpa and this is planned to remain steady until the end of the operation at an average product grade of 37.5% Mn. Table 13 shows a summary of the Mamatwan LoA plan while Figure 21 shows ROM tonnes and feed grades on an annual basis. Grades decrease from 37.5% Mn in FY25 to 36.5% Mn in FY32.

Table 13 Summary of Mamatwan FY15 LoA plan

Category	Unit	FY15	FY16	FY17	FY18	FY19	FY20	FY21	FY22	FY23
Run of Mine										
Central ROM	kt	353	-	-	2,198	1,708	3,194	2,744	3,237	2,368
North ROM	kt	323	3,221	363	-	-	-	-	-	-
South ROM	kt	2,586	-	1,452	-	-	132	-	-	-
West ROM	kt	-	-	1,447	1,085	1,359	-	782	563	1,532
Total ROM	kt	3,262	3,221	3,263	3,283	3,067	3,326	3,526	3,800	3,900
Mn	%	37.9	37.1	37.6	37.3	37.3	37.4	37.6	37.9	37.5
Fe	%	4.5	4.9	4.4	4.4	4.3	4.4	4.4	4.6	4.5
Overburden										
Central OB	kt	2,011	1,328	2,368	12,290	9,000	17,308	6,734	18,524	10,783
North OB	kt	1,198	2,979	-	-	-	-	-	-	-
South OB	kt	1,303	1,212	583	40	4	-	-	-	-
West OB	kt	14,488	12,482	15,050	5,671	10,997	2,693	20,248	1,477	9,411
Totals	kt	19,000	18,000	18,001	18,001	20,001	20,002	26,981	20,001	20,194
Stripping ratio	t:t	5.8	5.6	5.5	5.5	6.5	6.0	7.7	5.3	5.2

Category	Unit	FY24	FY25	FY26	FY27	FY28	FY29	FY30	FY31	FY32	Totals
Run of Mine											
Central ROM	kt	2,313	3,800	679	2,648	1,290	-	882	198	-	27,611
North ROM	kt	-	-	-	-	-	-	-	-	-	3,907
South ROM	kt	8	-	-	-	-	-	-	-	-	4,179
West ROM	kt	1,565	-	3,121	1,252	2,510	3,900	2,414	2,777	2,223	26,530
Total ROM	kt	3,885	3,800	3,800	3,900	3,800	3,900	3,296	2,974	2,223	62,227
Mn	%	37.5	37.6	37.2	37.4	37.1	36.9	37.0	36.5	36.4	37.3
Fe	%	4.6	4.9	4.4	4.5	4.4	4.4	4.4	4.5	4.5	4.5
Overburden											
Central OB	kt	10,653	12,572	885	4,252	514	-	-	-	-	109,221
North OB	kt	-	-	-	-	-	-	-	-	-	4,177
	kt	-	-	-	-	-	-	-	-	-	3,141
	kt	13,326	7,429	20,116	16,787	20,487	19,018	-	5,405	2,542	197,626
Totals	kt	23,979	20,001	21,000	21,038	21,002	19,018	-	5,405	2,542	314,164
Stripping ratio	t:t	6.2	5.3	5.5	5.4	5.5	4.9	-	1.8	1.1	5.0

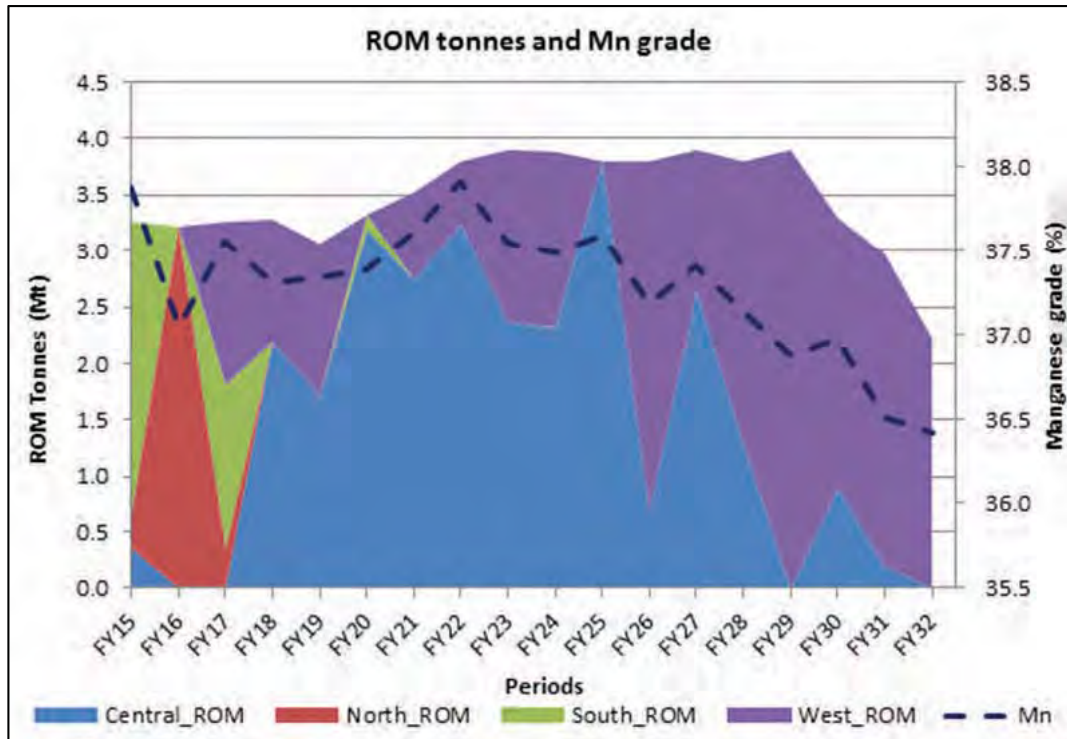

Figure 21 ROM tonnes and feed grade

Figure 22 shows the waste mining profile and stripping ratio on a yearly basis. High waste stripping is expected in FY21 and FY24 to maintain the planned ore tonnage profile.

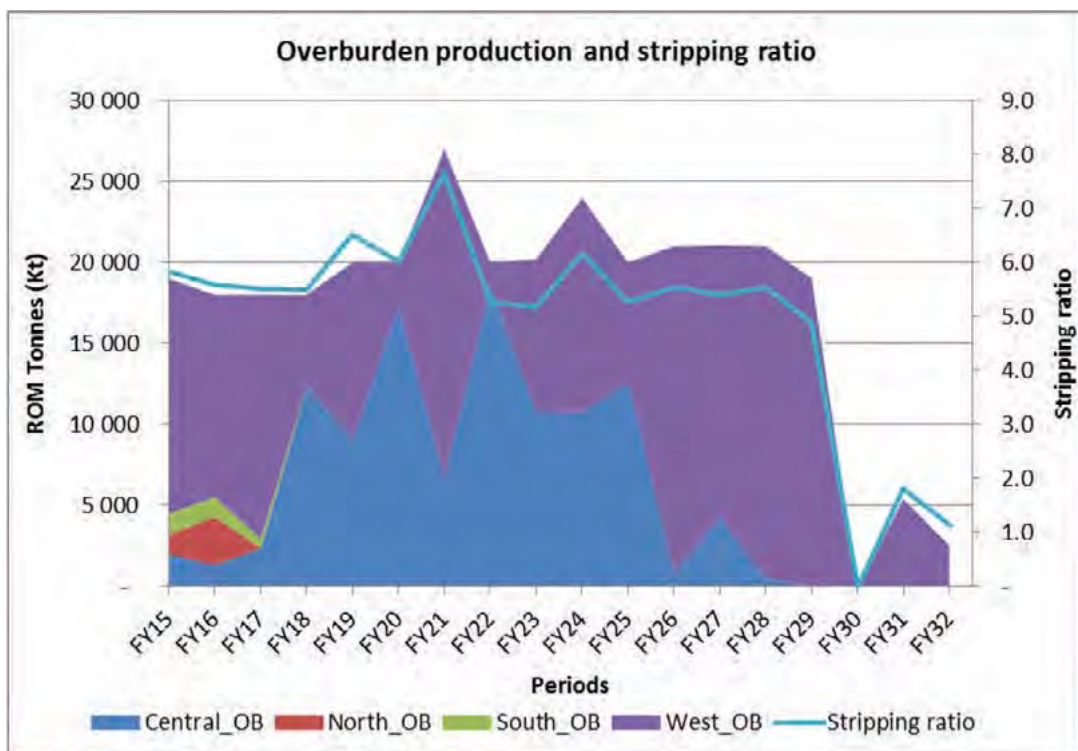

Figure 22 Mamatwan mine overburden profile

3.5.3 Historical Production and Expenditures

Table 14 shows a summary of historic production and costs. ROM ore production increased from 2.8 Mt in FY11 to 3.4 Mt in FY12 and dropped to 3.2 Mt in FY13. The ROM cost increased from 85.8 ZAR/t in FY11 to 186.7 ZAR/t in FY13. This is attributed to increases in input costs and high stripping to expose ore tonnes. Mining of overburden increased from 14.9 Mt in FY11 to 15.8 Mt in FY12 and 16.5 Mt in FY13.

Table 14 Summary of last three years production and costs

Description	Unit	FY11	FY12	FY13
Costs				
Labour	ZAR M	37.75	46.45	116.70
Fuel	ZAR M	31.90	52.39	81.53
Maintenance - Plants	ZAR M	42.88	47.79	91.77
Drilling	ZAR M	9.01	11.15	22.27
Loading & Hauling	ZAR M	41.02	67.79	122.70
Explosives	ZAR M	16.42	21.59	43.30
Infra Allocation	ZAR M	53.57	88.27	160.75
Stock Movements & Other	ZAR M	4.05	9.55	-49.06
Total	ZAR M	236.60	344.98	589.95
Production				
Overburden	kt	14,854	15,818	16,469
ROM Production	kt	2,757	3,425	3,160
Quality Product (from plant)	kt	2,909	3,373	3,078
M1L	kt	1,270	1,673	1,660
M1L Kawasaki	kt	1,027	1,102	939
M1 Fines	kt	612	599	480
Mamatwan Total Saleable Current Plan	kt	1,457	1,821	1,668
M1L	kt	1,270	1,673	1,660
M1 Fines	kt	187	147	8

3.5.4 Reconciliations over last three years

Table 15 summarises tonnages defined in the Mineral Resources, Ore Reserves and actual mine production over the last three years. Three reconciliation processes were followed:

- F1: The ratio of the grade control model with the Ore Reserve model
- F2: The ratio of the process feed with the grade control model
- F3: The ratio of actual production with the Ore Reserve model, as a measure of how well the long-term estimate predicts the actual production.

Comparative reconciliations over a two year period since the start of FY13 are available for both Mamatwan and Wessels and have been graphed by CSA Global to show F1, F2 and F3 for the tonnes, Mn grade and Fe grade, all as relative percentages (see Section 4.4.4, Figure 38). Overall these indicate reasonable conformity of the Production to Ore Reserves (F3) and the Grade Control to Ore Reserves (F1). As expected there is mostly good correlation of F2 and F3.

Table 15 Historic tonnages used for reconciliation over the last three years

Category	2012		2013		2014		Remarks
	Tonnes (kt)	Mn (%)	Tonnes (kt)	Mn (%)	Tonnes (kt)	Mn (%)	
Estimated global resource depletion	2,912.0	37.6	3,278.4	37.9	3,555.9	37.7	Delineation and estimation of mined-out areas in global resource model
Estimated global reserve depletion	2,912.0	37.6	3,227.2	36.7	3,521.8	37.7	Mined-out global reserve, estimation from MineSight model
Estimated grade control reserve depletion	2,918.4	37.1	3,369.9	37.1	3,239.6	37.1	Mined-out grade control reserve, estimation from MineSight model
Surveyed mine movement	2,974.2	37.1	3,566.8	37.1	3,090.6	37.1	Blast blocks survey tonnes. Grades from grade control model
Tonnes ROM hauled from pit	3,037.1	37.1	3,411.3	37.1	3,048.8	37.1	From ROM weightometer
ROM feed into OPP	3,050.5	37.1	3,413.6	37.1	3,006.5	37.1	From ROM weightometer
Total tonnes quality product produced	2,902.2	37.0	3,347.0	37.1	2,947.9	37.0	Weighted average grade, tonnages from plant weightometers
Total tonnes M1L lump produced	1,444.7	37.1	1,737.5	37.3	1,664.7	37.2	Product grade from plant samples
Total tonnes M1L 6x40 produced	1,005.5	37.0	1,052.3	37.0	842.5	37.0	Product grade from plant samples
Total tonnes M1 Fines produced	452.0	36.7	557.2	36.4	430.7	36.4	Product grade from plant samples
Quality product opening stock (M1L, 6x40 and fines)	190.7	38.2	130.5	37.0	418.5	37.1	Weighted M1L, 6x40 and M1F grades from the respective financial years
Total tonnes to Kawasaki crushers for DMS	987.6	37.0	1,005.9	37.0	825.5	37.0	Grades from 6x40 mm product
Fines to Sinter	358.4	36.7	366.0	36.4	490.6	36.4	Grades from -6 mm fines product
Railings / Stock depletion	2,973.1	37.2	3,056.4	37.1	2,932.7	37.1	OPP and railings grades from the respective financial years
Quality product closing stock	130.5	37.2	418.2	37.1	388.4	37.0	OPP and railings grades from the respective financial years
Total tonnes sinter produced	630.1	45.8	642.5	46.7	688.6	46.3	Weighted grades of products MHS, MMS and MSS
Sinter opening stock	34.6	46.5	18.9	45.8	34.0	46.7	Previous financial year's weighted grades of MHS, MMS and MSS
Sinter railings / Stock depletion	640.5	45.9	627.3	46.8	573.2	46.2	OPP and railings grades from the respective financial years
Sinter closing stock	44.5	45.9	34.0	46.7	77.7	46.3	Weighted grades of products MHS, MMS and MSS for the respective financial years.

In FY12 and FY13 the tonnes of product reconciled against the Ore Reserve (F3) in **bold font** in Table 15, were within 4% and the grade was respectively lower by 0.6% and higher by 0.4% Mn. In FY14 the total tonnes produced were lower than the estimated Ore Reserve depletion (i.e. that was mined) by 16% and the grade was lower by 0.7% Mn.

3.5.5 Comparison of the blast hole model with the resource model

A check on the blast holes used for short-term (grade control) modelling is provided in Table 16 and indicates that the tonnes and grade are satisfactorily predicted by the resource modelling on a quarterly basis.

Table 16 Mamatwan F1 reconciliation: blast holes against Mineral Resource model

Green: within ±5%, Yellow: within ±10%, - indicates no data.

	Tonnes (t)	Mn (%)	Fe (%)	CaO (%)
FY13 Q1	100.80	96.80	98.00	-
FY13 Q2	102.10	97.30	96.60	-
FY13 Q3	98.60	98.00	99.30	-
FY13 Q4	96.10	99.20	102.60	-
FY14 Q1	101.80	98.30	96.00	-
FY14 Q2	103.70	98.80	99.30	-
FY14 Q3	103.90	98.50	98.60	93.50
FY14 Q4	103.30	98.50	101.20	105.30
FY15 Q1	103.70	99.40	96.10	99.10
FY15 Q2	100.30	99.50	95.40	104.70

3.5.6 Modifying Factors

The mining related Modifying Factors are based on current assumptions, appropriate estimation models and historic performance. These factors include dilution, ore loss, geotechnical parameters, cut-off grades and environmental considerations and requirements.

The Modifying Factors applied to the Mamatwan Life of Mine plan to convert the Mineral Resource to the Ore Reserve are summarised in Table 17. These are accepted as appropriate by CSA Global.

Table 17 Mamatwan Mine Modifying Factors in the FY15 LoA plan

Modifying Factors	Amount (%)	Notes
Geological losses (M, C and N Zones)	6	Losses due to dykes and faults. Applied as a global loss.
Geological losses (X Zone)	6	Losses due to dykes and faults. Applied as a global loss.
Boundary pillar losses	1.7	Mamatwan has a right of ingress on the neighbouring property which enables sufficient waste stripping for optimal Ore Reserve extraction up to the existing mining right boundary
Slimes losses	4	
Dilution	0	The seam thickness is approximately 20 m with clear visual controls. Zero dilution is assumed. This does not consider the unevenness of the floor, the practicality of mining and equipment operator efficiencies.
Ore loss	2	Losses of ore due to the unevenness of the floor.
Fines losses	2	Losses due to fines generated at the secondary crusher screening plant
Cut-off thickness	3 m	This is relevant to the X Zone only. Approximately 44% of the X Zone is below the practical mining thickness of 3 m. This material is mined as a unit as part of the Top Cut and dumped as waste. Mining with excavators or shovels would cause significant dilution. Currently Front End Loaders (FELs) are envisaged for loading the X Zone.

3.5.7 Cut-off grade

A tonnage and grade profile was constructed by CSA Global to illustrate the effect of material below the stated cut-off grade (Figure 23). A total of 3% of the MCN Mineral Resource is below the established cut-off grade. The cut-off applied to the MCN and X Zone of 35% Mn is based on current marketable product requirements.

3.5.8 Mine Schedule

The mine design and production schedule were developed using MineSight software. Several objectives were used to optimise the production profile:

- Produce a constant Lump product grade of 37.5% Mn
- Minimise the stripping ratio
- Minimum mining height of 3 m on X Zone
- Follow a prescribed mining direction.

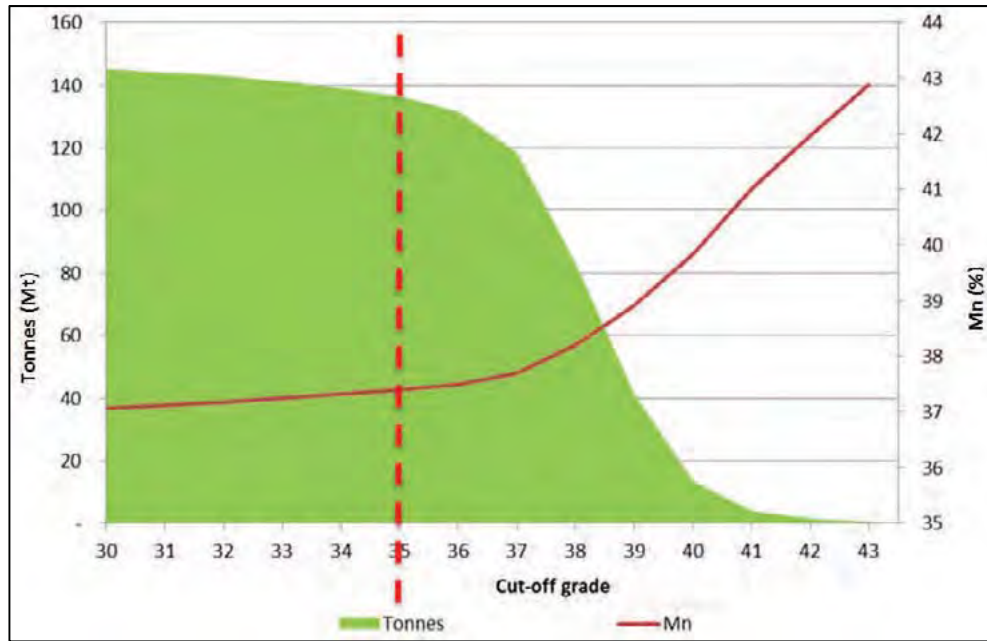

Figure 23 Mamatwan Mine tonnage and grade profile
The red dashed line is the 35% Mn cut-off grade

Overburden mining in the Central, North and South Blocks takes place at a similar depth while the MCN in the West Block lies deeper requiring more overburden stripping. Figure 24 shows the ore and waste production profile for Mamatwan operation.

Investigation is underway into mining the full Top Cut to provide a low grade stockpile for future processing at the end of the life of the operation.

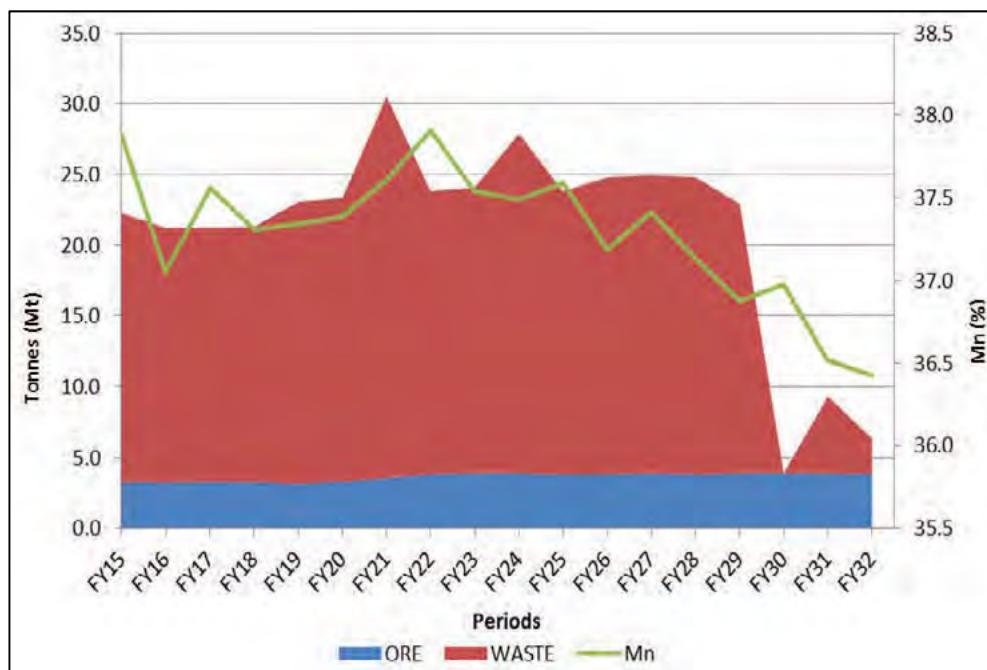

Figure 24 Mamatwan Mine production profile

3.5.9 Risks –Mamatwan Mine

CSA Global Assessment

The risks to the sustained production at an optimised cost profile can be summarised as follows:

- Export rail capacity is currently a bottleneck to production. A steady state of production at 3.8 Mtpa ROM is envisaged once the constraint eases.
- There is 3.9 Mt of X Zone material identified as ore in the LoA plan and Ore Reserve. It is considered that this will not be mined as proposed in the CP FY14 report but that it is still likely to be recovered at the end of mine life if the Top Cut is mined and stockpiled as low grade material. This is considered by CSA Global to be the more likely scenario but has not been demonstrated sufficiently at this stage.
- The establishment of an additional bench to access the X Zone as ore requires additional stripping and the lowering of the operating pit slope angle. This would result in a spike in the strip ratio without an overall increase in production.
- Future domestic sales requirements may impact on production.
- Mining capacity is based on the location of the in-pit crusher. Movement of the crusher will be a big issue at some stage during the LoA. It is planned for FY25.
- The clay above the Top Cut reaches a thickness of 15 m in some areas of the pit. This means more stripping for the same ore production profile due to the lower operational and final pit slope angles. Ongoing assessment and monitoring of the clay is required on an ongoing basis to ensure that this can be done safely and cost effectively.

None of these risks are considered by CSA Global to have a material impact on the Ore Reserves over the projected life of the Mamatwan Mine.

3.5.10 Mamatwan Ore Reserves Statement

The Ore Reserves for Mamatwan Mine have been examined and validated by CSA Global under the JORC Code (2012). CSA Global accepts the Ore Reserves stated by Hotazel at 30 June 2014 and has depleted them to 31 December 2014. The Mamatwan Ore Reserves estimate based on the CP FY14 report and the FY15 LoA plan, depleted to 31 December 2014 is provided in Table 18. The end of month September 2014 surface and three months forecast to end of year 2014 were used to deplete the Ore Reserve estimate.

Table 18 Mamatwan Mine Ore Reserves estimate at 31 December 2014

Category	Ore type	Cut-off grade (% Mn)	Tonnes (Wet Mt)	Mn (%)	Fe (%)
Proved	MCN Zones	35	17.3	37.7	4.4
	X Zone	35	1.5	38.3	4.7
	Total Proved	35	18.7	37.7	4.4
Probable	MCN Zones	35	41.0	37.1	4.5
	X Zone	35	2.4	36.7	4.8
	Total Probable	35	43.4	37.1	4.5
Totals by Zone	MCN Zones	35	58.3	37.3	4.5
	X Zone	35	3.9	37.3	4.8
Total Ore Reserves		35	62.2	37.3	4.5

A cut-off grade of 35% Mn is used to define mineable ore blocks.

4 Wessels Underground Mine

4.1 Local Geology

A discussion of the regional geology was provided above in Section 3.1.

Wessels Mine extracts high grade (above 47% Mn) manganese ore. The ore is typically coarse-grained, shiny, massive or vuggy, with the principal minerals being hausmannite and braunite II (Wessels-type ore), as opposed to primary, lower grade braunite further to the south in the Kalahari Basin (Mamatwan-type ore). The current interpretation is that the Wessels-type ore was formed by hydrothermal alteration of primary Mamatwan-type ore and that the alteration took place along a system of post-Olifantshoek, north-south and east-west striking normal faults.

Figure 4 showed the local fault structures and relative positions of the Mamatwan and Wessels mines. The stratigraphy conforms to that in the Kalahari Manganese Field (see Figure 5).

4.2 Mineral Resource Estimation

A geological block model dated June 2013 was constructed and used in the estimation for the CP FY14 Mineral Resource statement (Ferreira *et al*, 2014b).

There were 18 diamond drill holes added to the database which were used to update the geology and grade estimate for the new model. The new drilling concentrated primarily on the northern sub-outcrop of the Hotazel Formation as part of an ongoing resource development programme.

4.2.1 Drilling, Logging and Sampling

Data used to construct the geological block model and estimate the Mineral Resource is primarily from surface diamond core drilling, chip samples obtained from production face sampling and geological mapping. Underground drill holes are typically drilled oblique or parallel to the ore and are used for structural interpretation and delineation of mining, not for Mineral Resource estimation.

The primary manganese resource is contained in the 2 seams called the Upper Body (UB) and Lower Body (LB). The average thickness of these Mn seams ranges from 4.5 to 5.5 m.

All holes since 2009 were assayed at the site laboratory by XRF for a selection of Mn, Fe, SiO₂, Al₂O₃, CaO, MgO, P, S, Na₂O, BaO and K₂O. Prior to 2009 only Mn and Fe were assayed by XRF, with the exception of selected samples which were assayed off-site. In 2009 ICP was introduced at the Mamatwan laboratory, allowing the full suite of elements to be done routinely.

The average surface drill hole spacing is 100 m. There are 320 surface drill holes that intersect the UB, and 230 that intersect the LB. The 18 recent drill holes shown in Figure 25 were added to the database for the Mineral Resource estimate. This Figure also shows the limits of the UB and LB wireframes that constrain the mineralisation for the Mineral Resource estimation, and the mining block names.

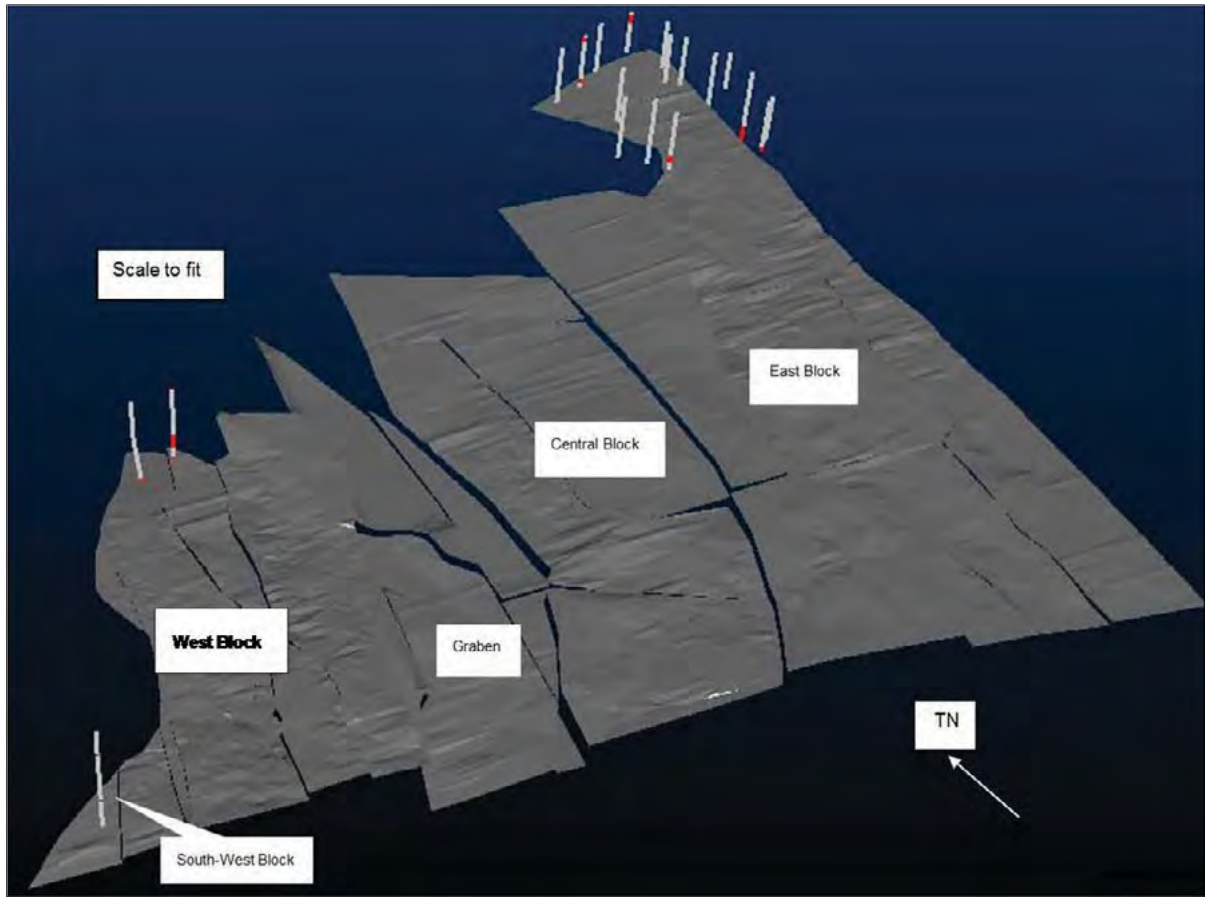

Figure 25 Plan view of 18 new drill holes used in the Mineral Resource estimate
Also showing the mining Blocks and wireframes of LB. Source: Hotazel

There were 19 drill holes excluded from the Mineral Resource estimate for the following reasons:

1. Missing assay values
2. Incorrect lithological boundary demarcation
3. Hole abandoned during drilling.

A plan view of the Wessels drill hole collars is presented in Figure 26. Drill holes which intersect either UB, LB or both and were used in the June 2013 Mineral Resource estimate are coloured green, and those drill holes not used are coloured blue. All other holes in the database are coloured red.

All drilling is carried out by external contractors who are required to comply with BHP Billiton standards and protocols. The average drill core recovery at Wessels Mine is 95%. Recovery is a key component in the contractual agreement between the Company and the drilling contractor. The location of all surface drilling is checked and the down hole survey, lithology and assay information is verified by project geologists to ensure consistency in interpretation of UB and LB positions.

Underground LB mining faces are chip sampled usually as two channels, one to the left and one to the right of the centre line, perpendicular to the dip direction of the face. This procedure is repeated after every blast, i.e. every 2.5 to 3.1 m. Each channel is 10 cm wide and 5 cm deep and divided into one metre intervals within the ore, starting at a central marker called the grade line, with variable length samples taken at the hangingwall and footwall contacts respectively.

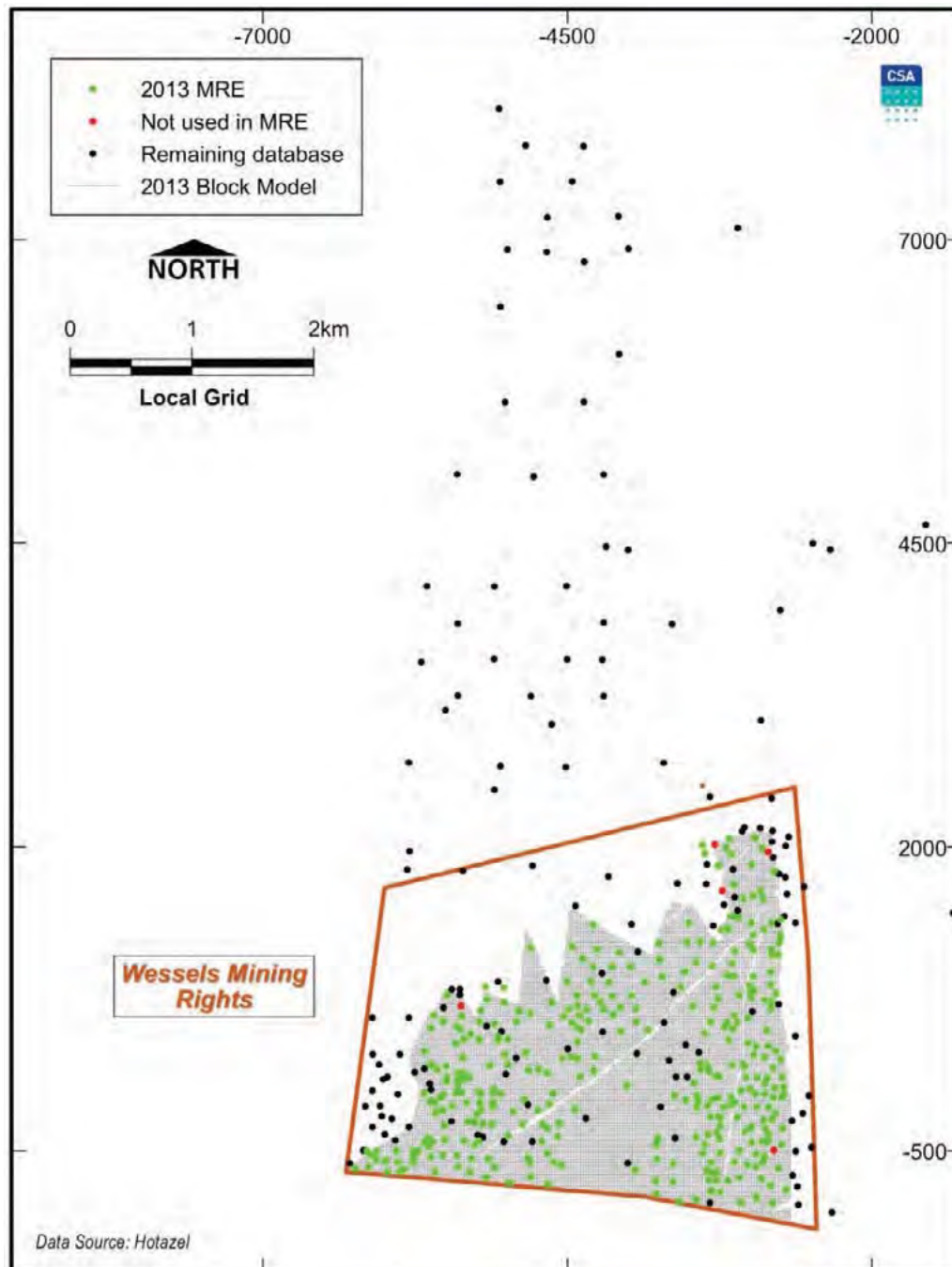

Figure 26 Plan view of Wessels drill holes
*Red – holes outside UB or LB; Blue – holes in UB or LB not used for the MRE;
 Green –holes intersecting UB or LB and used for the MRE*

The face-sampling database consists of 495,549 samples from the LB West Block, Central Block and East Block (Figure 25). The historical face sampling data before 1995 is not available, reducing confidence in the evaluation of the remnant pillars in the central and south-eastern areas of the mine. A program has been put in place for sampling of the remnant resource pillars in the old areas, where accessible. All relevant drill hole geology and sample information is stored in the Micromine GeoBank database. Collar survey data is processed in Microstation before transfer to GeoBank.

Data validation of assay data includes: consistency of drill hole numbering; a review to ensure that Mn + Fe does not exceed 100%; a check on any missing and/or negative grades with reassaying if required; and execution of a hole summary and errors detection function during merging of assay and lithology intervals in Datamine to ensure no sample duplication or overlap exists. All errors identified are referred back to the project geologist for correction in the primary database.

Table 19 and Table 20 present summary data for the surface drill holes used to construct the geology model.

Table 19 Summary of the Wessels drill hole database at October 2014 indicating data used in the Mineral Resource estimate (MRE)

Hole group	Count of drill holes	Metres of drilling	Count used in MRE	Metres of drilling used in MRE
D	18	4,000.0	6	1,524.9
DB	66	17,036.8	38	10,409.0
DK	24	6,207.9	12	3,665.0
DUB	11	269.6	11	269.6
J	11	687.6	-	-
UB	153	3,857.0	142	3,622.8
W	190	67,006.9	132	51,147.1
WEX	34	11,381.0	-	-
WUB	9	184.3	9	184.3
Grand Total	516	110,630.9	350	70,822.7

Table 20 Sample data in the Wessels surface drill hole database at October 2014, indicating data used in the Mineral Resource estimate (MRE)

Unit group	Metres assayed	Count of samples	Metres used in MRE	Count of samples used in MRE
WSL UB	1,199.7	2,302	1,199.7	2,302
WSL LB	991.6	1,830	968.8	1,803
Total for Mn units	2,191.3	4,132	2,168.5	4,105
Total for non-Mn units	2,230.2	3,337	2,154.3	3,251
Total metres sampled	4,421.5	7,469	4,322.8	7,356
Total metres drilled	110,630.9			

The nominal sampling interval for diamond core was 0.5 m historically and is now 1 m, with samples cut at lithological boundaries. A review of sample lengths within UB and LB seams shows a median length of 0.5 m and a mean length of 0.62 m with the 10th percentile at 0.23 m and 90th percentile at 1 m.

All core to be sampled is split with a diamond saw, with one half sent for chemical and physical analysis, and the other stored for future reference. All sample preparation, including crushing and pulverizing, is done on site with the pulps being sent to the site laboratory for assay. All recent surface drill hole core is stored in the centrally located core yard at Hotazel. Some historical core drilled prior to 1995 is no longer available but this is from mined-out areas at Wessels.

Mamatwan and Wessels Mines use the same core yard and sample preparation facility at Hotazel Township. Different site laboratories are used but the practices of XRF assaying with LIMS data capture are the same for both mines.

Random duplicate samples (an average of 1 in 5 for the Mn seams) are generated and submitted to the laboratory as part of the QAQC requirements. Regular round-robins with other independent laboratories are performed to ensure in-house accuracy. Precision and accuracy of Mn and Fe analysis is validated against African Mineral Standards (AMIS) certified reference materials (AMIS 0402, 0403, 0404, 0406 and 0407). Quality Control reports are completed daily at the laboratory, showing all standards and results within the laboratory.

CSA Global Assessment

The sampling procedure has been previously audited by independent consultants. It was examined by CSA Global and is considered acceptable for the purpose of Mineral Resource estimation.

Review of duplicate assay results, certified reference material and pulverisation size fractions indicate that the sampling protocols adopted for the sampling and assaying of drill hole core and face samples are valid and appropriate for Mineral Resource estimation. Blanks which are normally part of sample preparation procedures are not used, due to the consistent grade of ore and contaminants. CSA Global does not consider this to be material.

Plots showing pulverising efficiency data for the Wessels laboratory are used to demonstrate adequate pulverising of samples in preparation for chemical analysis. These were previously noted as an issue in 2012. CSA Global considers that monitoring of pulverising still requires some improvement but is not considered a material risk.

4.2.2 Geological Interpretation

Geological interpretation is based on diamond drilling, underground mapping and face sampling. Substantial knowledge has been accumulated since 1973 when Wessels Mine came into production. Local tonnes and grade predictions can be impacted by small-scale geological structures which are managed on a daily basis during mine production.

The UB and LB are divided into 4 domains. The domain boundaries are defined by the major fault blocks identified in the LB: West, Graben, Central and East. Each domain reflects the local structural setting which controls the orientation, anisotropy and ferruginisation of the ore. The West and East Blocks are currently better sampled than the Central and Graben Blocks. A 3D view of the Wessels domains is presented in Figure 27. Wireframes defining the top and bottom of both the UB and LB were constructed from the drill hole data and truncated by the mineral lease boundary.

Figure 28 is a 3D perspective view facing north showing surface and underground drilling related to the UB and LB wireframes (note the vertical exaggeration is times 3).

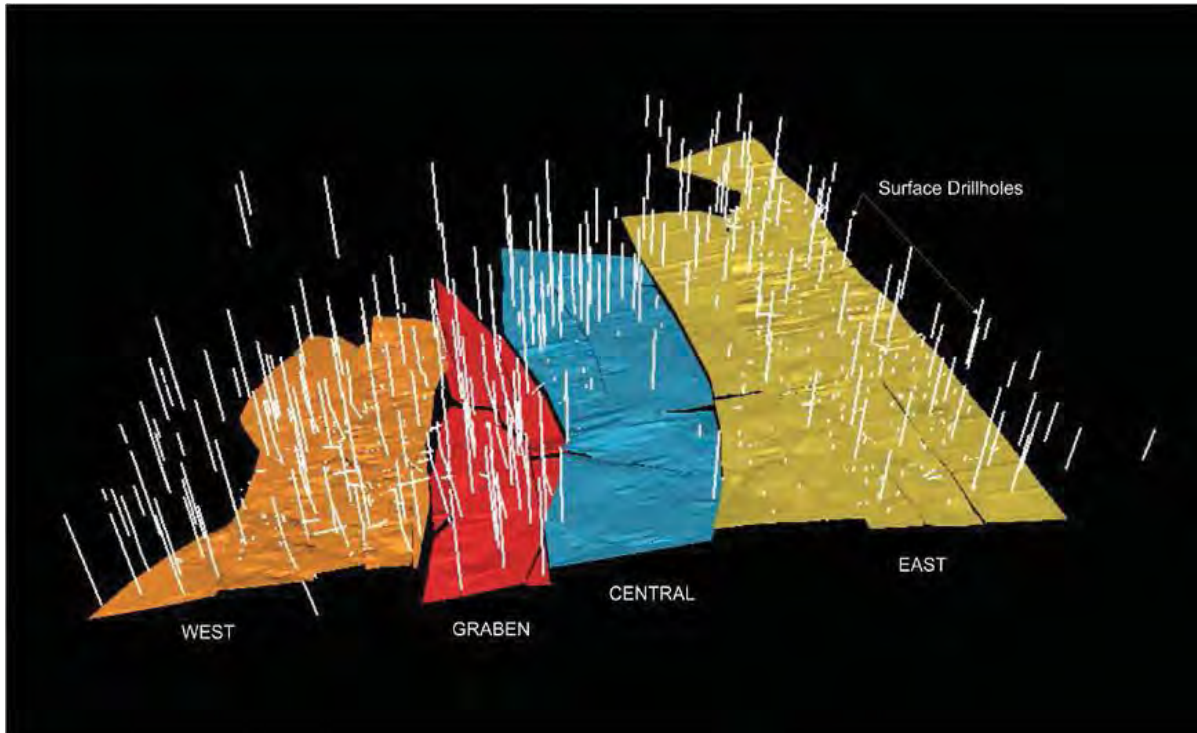

Figure 27 3D view of drill hole data and Wessels mining Blocks (vertical exaggeration x3)
Source: Hotazel

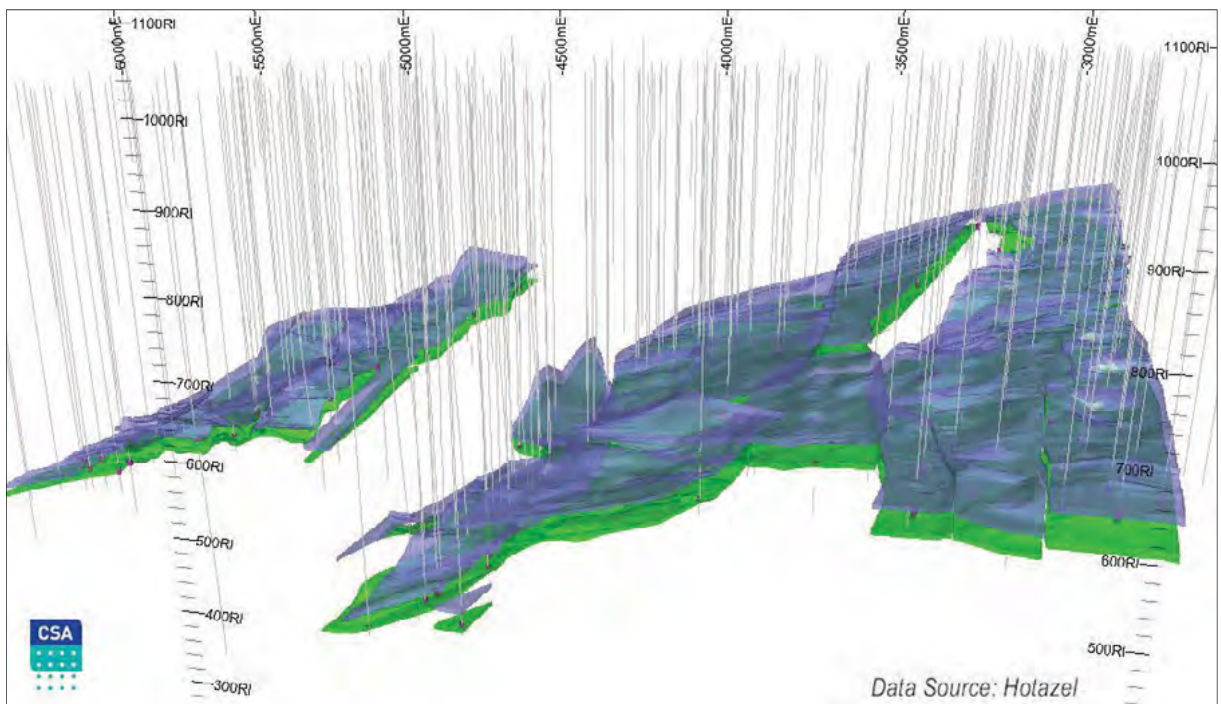

Figure 28 3D view facing north, showing UB (blue) and LB (green) wireframes and drilling
(vertical exaggeration x3)

4.2.3 Geostatistical Analysis and Estimation

Statistical analysis of both the drill hole and face sample data was completed for the UB and LB manganese seams. The UB and LB are lithologically different with distinct geological and grade characteristics, so they were treated independently, i.e. the UB and LB were considered as 'hard boundaries' for grade estimation.

A number of studies (both by site personnel and by external consultants) have been completed to determine how best to use face samples from underground development for grade estimation in the Mineral Resource estimate. The current adopted procedure is to use a 20 m by 20 m 2D declustering process which results in compositing the 403,051 valid face samples to around 3,000 composite grade points. Comparative statistics were completed to ensure the composites are representative of the raw sample grades.

A review of the drill hole samples containing manganese mineralisation within the UB and LB was completed. A summary of the results are presented in Table 21. This suggests that, as noted above for Mamatwan (Section 3.3.3), there are outliers in the minor element data that should be reviewed if grades for these are to be estimated in future. This is expected to impact on local estimates but is not considered by CSA Global to be material for the Mineral Resource overall.

Table 21 Raw drill hole sample statistics for UB and LB combined in the Mineral Resource

Variable	Mean	10%	90%	CSA Global comments
Mn	41.10	28.70	51.60	Normal distribution, negatively skewed <25% Mn, LB on average 2% higher Mn grade.
Fe	17.50	7.00	31.10	Normal distribution, positively skewed >30% Fe, UB on average 4% higher Fe grade.
SiO ₂	3.20	1.29	6.71	Too few (62) samples to derive any conclusions.
Al ₂ O ₃	0.37	0.14	0.64	Strong positive skew >1.5% Al ₂ O ₃ .
CaO	6.17	2.60	10.97	Normal distribution, positive skew >12% CaO, LB on average 2% higher CaO grade.
MgO	0.82	0.30	1.73	Strong positive skew.
P	0.04	0.01	0.07	Strong positive skew.
S	0.13	0.01	0.29	Strong positive skew.
Na ₂ O	0.21	0.01	0.40	Too few (49) samples to derive any conclusions.
K ₂ O	0.30	0.01	0.02	Too few (49) samples to derive any conclusions.
BaO	0.72	0.04	1.87	Too few (49) samples to derive any conclusions.

The manganese grades approximate normal population distributions averaging between 40% (UB) and 42% (LB) Mn with a slight negative skew related to small populations of Mn below 25%. The Fe grade population averages between 19% (UB) and 15% (LB) Fe and shows a strong positive skew related to a population of Fe samples greater than 30%. There are also a number of significant outliers within the minor element data.

A block model was constructed to honour the UB and LB wireframe volumes based on the parameters presented in Table 22.

Table 22 Block model parameters

Block model parameters	X	Y	Z
Parent block size (m)	20 (LB) 20 (UB)	20 (LB) 20 (UB)	500
Subcell size (m)	20	20	Unit seam height
Block model minimum (Local Grid)	-6,329	-1,114	497
Block model maximum (Local Grid)	-2,329	2,886	997
Total parent blocks	200 (LB) 100 (UB)	200 (LB) 100 (UB)	1

Ordinary Kriging of the Wessels deposit was deemed inappropriate by a consultant during trials that showed a high percentage of negative kriging weights and poor kriging efficiency. For this reason the grade interpolation is done using the inverse distance squared (IDS) method.

The 20 m by 20 m block size for Wessels is not meant to be a reflection of the effective mining unit size which is the mining advance for a blast of 2.7 m on an 8 m face of height 5 m. The block size does not impact on the quality of the estimation and the resource model does not reflect the expected daily variability of mining faces.

Spatial statistical analysis by examination and modelling of variograms for the UB and LB Mn seams was completed to derive orientations and search distances for IDS estimation, by domain for Mn and Fe. The orientation of the major axis was 095° with a plunge of 2° towards 275°. The variogram ranges for Mn in the LB were:

- West Block - 325 m along strike and 242 m across strike.
- Graben Block - 516 m spherical.
- Central and East Block - 500 m along strike and 380 m across strike.

The search criteria used for estimation of grade into the model blocks were a first search range of 50 m along strike and 30 m across strike, with a minimum of 4 and a maximum of 20 samples. Although the drill hole spacing is 100 m and the variogram range is also large, the use in the modelling of underground chip sampling data with a 3 m spacing means that the initial search range identifies predominantly the chip sampling data in the vicinity of the current mining faces. A second search range was used with twice the first range and a third pass with four times the first range. The number of samples for the subsequent passes was identical to the first search. This populated all LB and UB blocks in the current Mineral Resource model.

Grade estimation parameters were verified by model validation which included: a visual check of drill hole composite grades and block grades; a statistical comparison of declustered sample grades against block model grades; and graphical swath plots comparing grade trends by grid increment within each Mn seam.

In the FY14 Mineral Resource, grades for Mn and Fe were estimated for all blocks in both the LB and UB. The deleterious elements Fe, SiO₂, Al₂O₃, CaO, MgO, P and S were estimated only in the LB model for blocks where adequate sampling was available, varying from 70 to 93% of model blocks depending on the element.

An average *in situ* dry bulk density of 4.23 t/m³ was obtained from 1,053 samples from representative drill core and used to convert the volumes of ore to tonnes. Ore was defined as

above 37.5% Mn for UB and above 45% Mn for LB. Density was measured using the water displacement method. The same average density value of 4.23 t/m³ was used for the LB and UB.

4.2.4 Mineral Resource Classification and Statement

The Mineral Resources were classified after taking into account the guidelines specified in the JORC Code (2012) for reporting Mineral Resource estimates. Factors considered in the classification were: geological controls and continuity of UB and LB Mn seams; internal grade variability of Mn and Fe and the predictability of contaminant grades; quality and spacing of the drill hole sampling, assaying and geological logging; appropriate bulk density and moisture sampling to determine the tonnage factors; and potential for economic viability. Table 23 shows the Mineral Resource classification criteria.

Table 23 Criteria used to classify the Wessels Mineral Resources

Mineral Resources	Parameters
Measured	30 to 50m extension from mined-out areas, based on the variogram range at 66.6% of the population variance.
Indicated	The entire UB resource plus LB material that is not Measured. The sample spacing is within the range of the variogram model.
Inferred	There is no Inferred Mineral Resource defined currently at Wessels. The mine is lease constrained. Normally this would be material that is the focus of further exploration or development drilling.

A 3D view facing north showing the LB Mn seam coloured by Mineral Resource estimate classification with drill holes shown in light grey is presented in Figure 29.

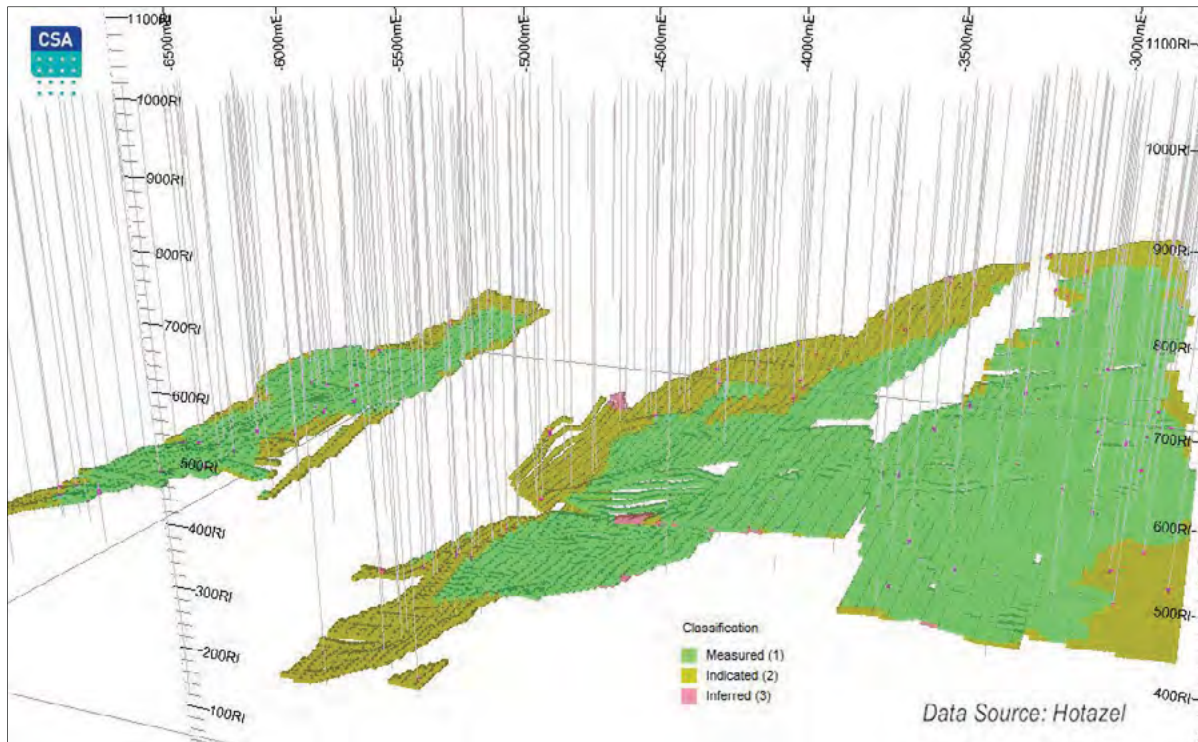

Figure 29 3D view facing north of LB Mineral Resource classification, with drill hole traces
(vertical exaggeration x3)

CSA Global Assessment

CSA Global has carried out appropriate validations of the Mineral Resource estimated by Hotazel for Wessels and accepts it as appropriate for the purpose of public reporting under the JORC Code (2012). CSA Global has reviewed these results and considers that the Mineral Resource estimate reflects both the geology boundaries and grade distribution defined by the drill hole sampling and geological logging. The methods used for data collection, validation, statistical analysis, grade estimation and classification are considered reasonable and the results are consistent with the data and in line with checks carried out by CSA Global.

CSA Global identified a number of issues with regard to the database, methodology and audit trail which could be enhanced for future Mineral Resource estimate reporting but which are not considered to materially impact on the estimates. These issues include:

- Use of a single dry *in situ* bulk density for converting volumes to tonnes for all high grade Mn material.
- Use of the face sampling channel data for the Mineral Resource estimate means that short-term (grade control) modelling data is also used for the long-term (Mineral Resource) modelling. This renders the reconciliations less useful. Comparing models built from different data sets would demonstrate the accuracy of the resource model (which is based on the drill sampling from surface for the majority of the material mined in the LoA plan).
- Reconsideration of using Ordinary Kriging to estimate the model grades, if the channel samples are excluded from the Mineral Resource estimate.

- Consideration of outlier values when estimating Fe and minor element grades (SiO_2 , Al_2O_3 , CaO , MgO , P , S , Na_2O , BaO and K_2O).

CSA Global accepts the Wessels Mineral Resource estimate at 30 June 2014 in Table 24. These Mineral Resources are inclusive of Ore Reserves, and were estimated using a cut-off grade of 45 % Mn for the high grade portion of the LB and 37.5% Mn for the rest of the LB and for the UB.

Table 24 Wessels Mineral Resource estimate at 30 June, 2014

Mineral Resources	Tonnage (Wet Mt)	Mn %	Fe %
Measured	15.2	44.2	12.9
Indicated	125.2	42.2	16.8
Measured + Indicated	140.4	42.4	16.4
Inferred	0.0	-	-
Total Mineral Resources	140.4	42.4	16.4

CSA Global has determined the depleted Mineral Resource for Wessels at 31 December 2014 by deducting actual production to 30 September and forecast production to 31 December 2014, to be as provided in Table 25. These Mineral Resources are inclusive of Ore Reserves, estimated using a cut-off grade of 45 % Mn for the high grade portion of the Lower Body (LB) and 37.5% Mn for the rest of the LB and for the Upper Body (UB).

Table 25 Wessels Mineral Resource estimate at 31 December, 2014

Mineral Resources	Tonnage (Wet Mt)	Mn %	Fe %
Measured	14.7	44.3	12.9
Indicated	125.2	42.2	16.8
Measured + Indicated	139.9	42.4	16.4
Inferred	0.0	-	-
Total Mineral Resources	139.9	42.4	16.4

4.3 Mining

4.3.1 Major Facilities

The massive tabular manganese ore body at Wessels is 300 m below the surface. It is accessed through vertical and twin decline shaft systems and mining uses the mechanized room and pillar

method. The vertical shaft is used primarily as a personnel and material hoisting facility while ore is conveyed to surface through the inclined shaft. Both act as intake ventilation shafts.

The ore is blasted and front end loaders, matched with 25 t dump trucks, deliver the ore to underground primary crushers situated in the East and West Blocks. An additional crusher is being installed for the Central Block. Ore is conveyed from the various crushers to a central ore handling system consisting of storage silos close to the vertical and inclined shafts. From here the ore is transported by a cable belt conveyor up the 14 degree incline to the washing and screening plant on surface.

4.3.2 Mining Method and Equipment

Mining is focused on the Lower Body (LB) and the Upper Body (UB) horizons. Only the LB is currently extracted, with extraction of the UB planned for later during the mine life. Various access points to the UB currently exist due to structural faulting and localized exploratory mining. The mine production is divided into the East, Central, Graben and West Blocks based on structural zones (Figure 30).

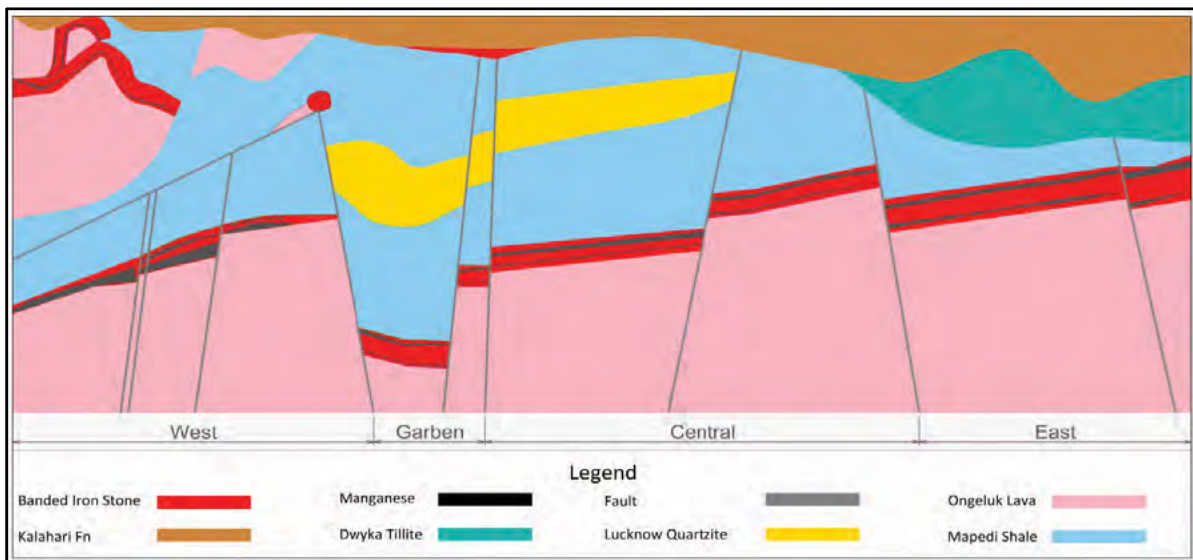

Figure 30 West- east cross section indicating structural zones in Wessels Mine

Source: Hotazel

The current mining areas include stoping operations in the East and West Blocks with initial development and infrastructure establishment in the Central Block. The relative location of the various structural blocks in plan can be seen in Figure 31.

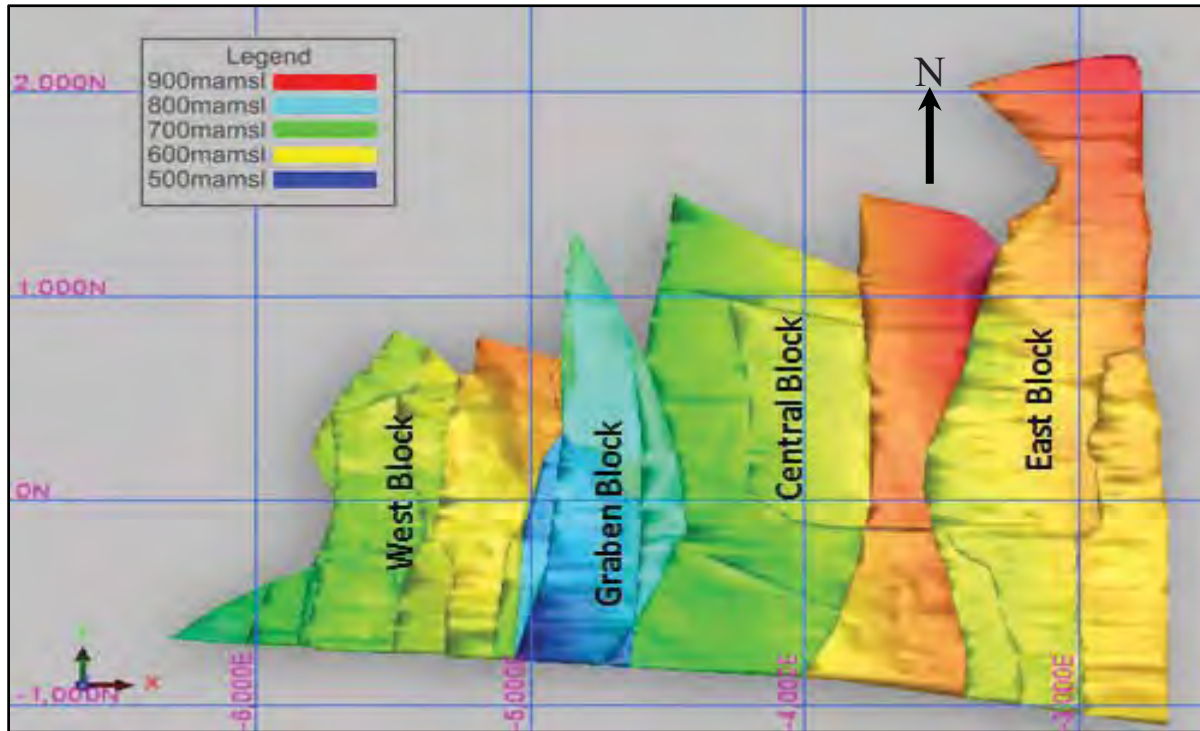

Figure 31 Plan indicating structural zones
Source: Hotazel

Pillar dimensions are 8 m x 8 m in the West and Central Blocks and 6 m x 6 m in the East Block with 8 m wide rooms throughout, to meet geotechnical requirements. The mining height varies from a minimum of 3.5 m to a maximum of 5.5 m, predominantly constrained by equipment operating requirements and physical ore body thickness.

Blasted ore is loaded using Load Haul Dump (LHD) machines onto 25 t articulated trucks which transport ore to a conveyor system in the mine. Primary ore crushing is conducted underground with ore storage in underground silos from where it is transported to surface by conveyor. The current room and pillar mining method at Wessels Mine is conventional and consists of: preparation, drilling, charging, blasting, mucking, cleaning and support. The mining strategy is to block development areas to establish through-flow ventilation and increase flexibility of the various grade products produced. High grade faces are mined, stockpiled and conveyed using timed hoisting schedules. Figure 32 shows a typical room and pillar mining layout at Wessels Mine.

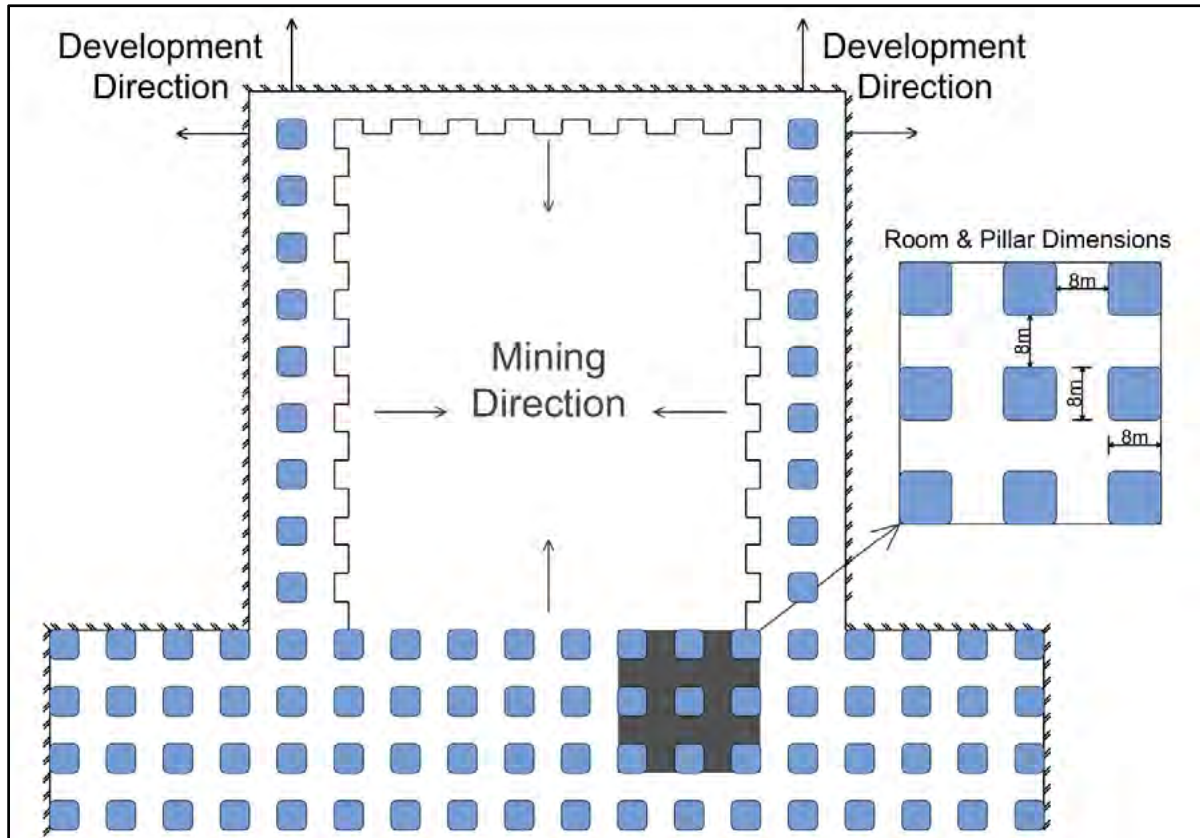

Figure 32 Development phase of the room and pillar mining layout
Source: Hotazel

Extensive face sampling is conducted to determine the ROM grade and qualities of the ore prior to extraction to determine the silo destination.

The mechanised underground mining equipment fleet comprises:

- Haul Trucks – Sandvic and CAT AD30
- Load Haul Dumpers (LHDs) – CAT R13-1700
- Roofbolters – Atlas Copco
- Drill Rigs – Boart Longyear
- Dozer – CAT
- Grader – Wright
- Scaler
- Light duty vehicles

Based on the current production requirements the equipment fleet should not pose any production constraints. With the anticipated build-up in the production profile to 1.5 Mtpa of ROM ore by FY17 the equipment requirement will be re-evaluated to ensure sufficient flexibility in mining operations.

4.3.3 Mine Production

The production capacity is constrained by the two primary crushers totalling 1.2 Mtpa ROM situated in the West and East Block mining areas. Increased crushing capacity will be established to a total of 1.5 Mtpa ROM once the planned Central Block infrastructure is completed.

Wessels ROM production is driven by product quality requirements to produce a high grade product at 47% Mn or a low grade product at 42% Mn. Stringent grade control measures are applied to produce high grade products using a 45% Mn cut-over grade (an upper grade limit). Lower grade products are defined above a cut-off grade of 37.5% Mn plus additional ore below the cut-off that can be blended into a W4 product. An additional 18% of this below cut-off grade ore can be blended to deliver an on-specification W4 product over the life of the operation. Four main products are produced at Wessels Mine:

- W1L – High grade Lump product (6mm-75mm size fraction)
- W1F – High grade Fines product (0.5mm-6mm size fraction)
- W4L – Low grade Lump product (6mm-75mm size fraction)
- W4F – Low grade Fines product (0.5mm-6mm size fraction)

Mine planning and production sequencing is based on a payability ratio. This is the ratio of high grade ROM ore relative to total ROM ore production for any given period. A payability of 35% is targeted which implies that 35% of the ROM hoisted is classified as high grade ore.

The only beneficiation required is crushing, screening and washing to produce a final saleable product. Of the blasted ore, 12% goes to Fines product (W1F and W4F) and 12% is lost to slimes.

4.3.4 Mine Infrastructure and Development

The current production is mainly focused in the East and West Blocks with initial development started in the Central Block. The East and West mining areas are each equipped with underground primary crushers with a third crusher scheduled in the Central Block for commissioning at the end of FY16.

Depletion of the West Block is scheduled for FY20 with the East Block depletion in FY22 based on the FY15 LoA plan. The planned production rates from the West and East Blocks decrease due to the increasing distance from current infrastructure. As the production declines in the existing areas, replacement and ramp-up of production is scheduled in the Central Block area. From here the focus moves to the UB with development scheduled for FY22. The UB contributes approximately 68% of the tonnes in the overall LoA plan. The remaining manganese ore in the Graben Block is scheduled for extraction at the end of the mine life due to the substantial capital requirement in terms of decline development and infrastructure establishment.

4.3.5 Rock Mechanics

The region is characterised by irregular basins and domes as well as nappe structures and recumbent folding, intimately related to the thrust system. Dips are gentle, normally less than 10°. Faulting is dominated by north-south and ENE–WSW trending systems of horst-and-graben structures and extensional structures, which may display scissor-type displacement. Fault displacements vary in scale from centimetres to metres. Subvertical displacements of up to 150 m

have been recorded. Differential movement parallel or sub-parallel to bedding planes also occurs. These are commonly defined at Wessels Mine as shear planes.

Dykes are primarily orientated in a northeast–southwest direction, often following older fault surfaces. Thicknesses vary from tens of centimetres to several metres (up to 70 m has been recorded) and are normally 20 to 30 metres. The dykes are commonly bostonite which is structurally stable when fresh but which can alter to softer material.

Pillars at Wessels Mine are designed to firstly support the overburden up to the surface and to also ensure safe working spans underground. To ensure overall stability of the mine the pillars are designed at a sufficient size to ensure that the full load of the overburden up to surface is supported. Substantial unmined areas exist particularly in the East Block due to low grade ore, poor ground conditions, dykes, faults, etc., the effects of which are not included in the pillar design strategy.

The pillar design is based on the tributary area theory for pillar loading. This means that the ‘dead weight’ of the overburden rock is distributed evenly over the pillars, ignoring the effect of the unmined areas mentioned above.

A geotechnical study conducted in 2007 by consultants to investigate the opportunity of mining the UB after the LB is extracted, referred to as multi-seam extraction, indicated that:

- Mining with inter-layer thicknesses of less than 10 m should be avoided.
- The mining sequence for the seams is not critical.
- Factors of safety should be at least 1.7 for pillar designs where the inter-layer thickness between the UB and LB horizons (referred to as ‘middling’) is less than 16 m.
- Mining heights in multi seam areas should be limited to 6.5 m.

The study indicated that a majority of the UB located in the East and Central Blocks would be extractable, with approximately 60% of the West Block resource area unavailable for mining due to middling thicknesses of less than 10 m. This is further discussed in Section 4.4.7.

4.3.6 Water

The mine has experienced some potable water supply shortages. Engagement with the local water supply authority was initiated to plan current and further operational requirements. Underground service water and structural water seepage is contained in large underground dams situated on the down dip or southern portion of the mining area.

4.3.7 Tailings

The tailings containment dam at Wessels covers an area of 450 by 230 m. It is constructed from granular manganese fines and clays so the walls are highly unlikely to liquefy or cause drainage problems. The Hotazel tailings containment areas have no history of instabilities over the past 30 years of mining. Tailings are pumped onto the top to evaporate.

4.3.8 Power, Ventilation, Escape Ways, Pumping

Continuity of power supply for safety appears appropriate and was discussed in Section 2.4.

Ventilation and escape ways are all considered to be sufficient for the purpose of ensuring mine safety but CSA Global has not audited these and does not claim the expertise to do so.

The mine is relatively dry and has appropriate pumping as required.

The Central Block of the LB is currently being developed and future infrastructure will be focused on the UB and then the Graben Block. Mining of the Graben Block will require a twin decline system for access as well as ore storage, crushing and ventilation infrastructure.

4.4 Ore Reserves

4.4.1 Processing

The operation is a producing mine that has been mining, beneficiating and selling product for a considerable period of time. Given that there is no expected change in the ore types or the beneficiation plant, the best indication of the future performance of the operation in upgrading the mined ore to saleable product is the historical performance of the plant. Mineral processing, metallurgy and geometallurgy are not further considered as there is no evidence of changes that would impact on the Ore Reserves as Modifying Factors affecting the processing of the manganese ore.

The ROM ore is crushed by underground primary crushers to -150 mm size. The ore is conveyed to the plant at surface where a secondary cone crusher reduces it to -75 mm. It is then screened and washed to produce various marketable manganese products. These are stockpiled after the washing plant based on size and grade specifications. Figure 33 illustrates the ore flow at Wessels Mine.

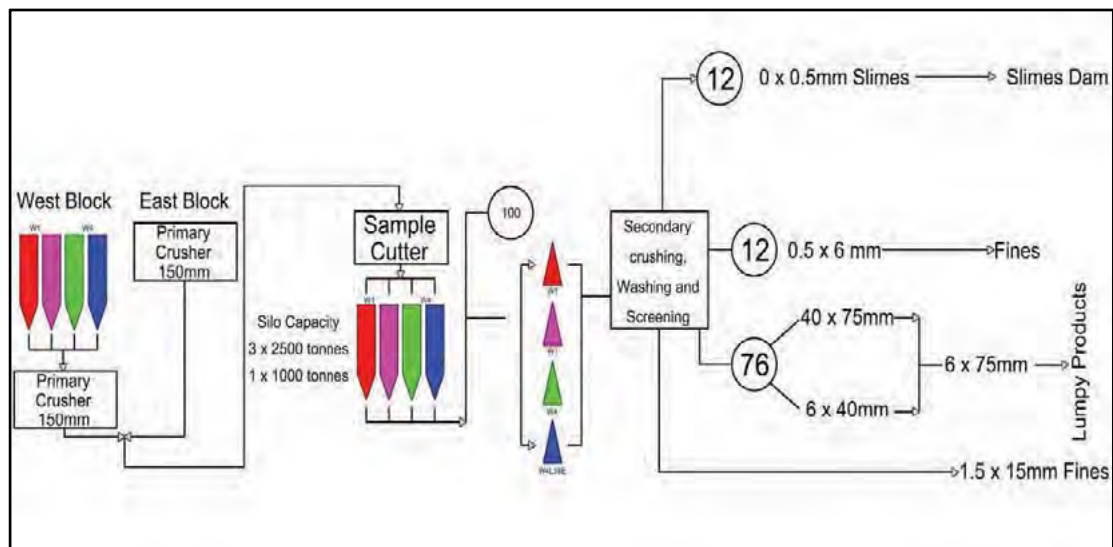

Figure 33 Ore flow at Wessels Mine and washing plant

Source: Hotazel

4.4.2 Life of Asset

The Wessels Mine FY15 LoA plan is shown in Figure 34 indicating the total ROM tonnes to be hoisted, by mining area. Production is scheduled at 1.1 Mtpa ROM for FY15 and FY16 with a planned increase to 1.5 Mtpa ROM from FY17. The anticipated production increase is maintained throughout the scheduled life of the operation.

Current mining is focused in the East and West Blocks of the LB with development in progress in the Central Block. Mining of the UB is scheduled to start in FY22 with the LB and UB in the Graben Block scheduled towards the end of the mine life. The majority of the ore is planned from the UB, approximately 68% on a tonnage basis. Limited mining has occurred from the UB horizon as it is primarily medium to lower grade ore.

Note that the LoA production schedule extends out to FY66 but includes some lower-grade material (9.1 Mt of W4L38 product) below the cut-off grade of 37.5% Mn. For the Valuation by CSA Global, based on the Ore Reserves of Wessels Mine (see Section 5.5), this material was excluded resulting in a mine life of 46.5 years until 30 June 2061, the end of FY61.

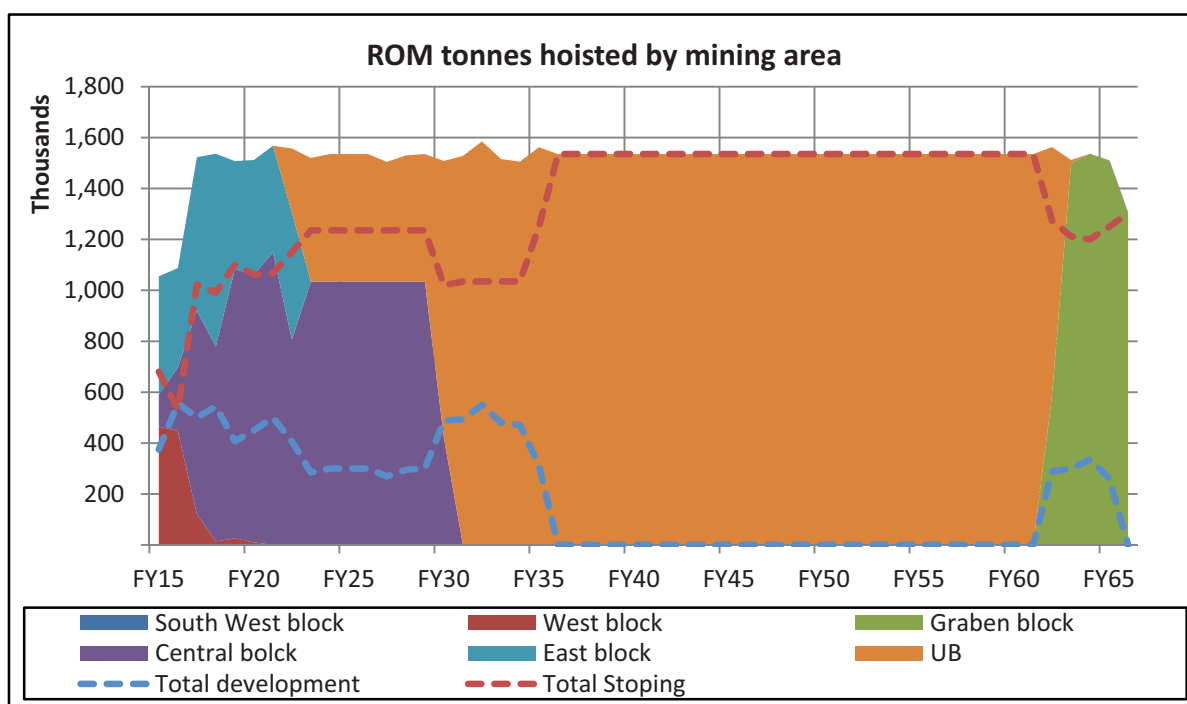

Figure 34 FY15 LoA plan showing tonnes hoisted by mining area

Table 26 shows a summary of the ROM tonnes scheduled in the FY15 LoA plan.

Figure 35 indicates the ore scheduled by ore type classification based on the FY15 LoA plan. The high grade (>47% Mn) W1 product is maintained in the LoA plan into FY22 from which year grades of 45% to 46% Mn are achieved. When the UB development commences in FY22 the product specifications will necessarily be adjusted downwards.

Table 26 Summary of ROM tonnes hoisted based on FY15 LoA plan

ROM Tonnes Hoisted	FY15	FY16	FY17	FY18	FY19	FY	FY21	FY22	FY23	FY24
LB (Mtpa)	1.06	1.09	1.52	1.54	1.51	1.51	1.57	1.31	1.04	1.03
UB (Mtpa)	-	-	-	-	-	-	-	0.25	0.48	0.50
Total (Mtpa)	1.06	1.09	1.52	1.54	1.51	1.51	1.57	1.56	1.52	1.54
ROM Tonnes Hoisted	FY25	FY26	FY27	FY28	FY29	FY30	FY31	FY32	FY33	FY34
LB (Mtpa)	1.04	1.04	1.04	1.04	1.03	0.42	-	-	-	-
UB (Mtpa)	0.50	0.50	0.47	0.49	0.50	1.09	1.53	1.59	1.52	1.51
Total (Mtpa)	1.54	1.54	1.50	1.53	1.54	1.51	1.53	1.59	1.52	1.51
ROM Tonnes Hoisted	FY35	FY36	FY37	FY38	FY39	FY40	FY41	FY42	FY43	FY44
LB (Mtpa)	-	-	-	-	-	-	-	-	-	-
UB (Mtpa)	1.56	1.53	1.54	1.53	1.53	1.54	1.54	1.53	1.54	1.54
Total (Mtpa)	1.56	1.53	1.54	1.53	1.53	1.54	1.54	1.53	1.54	1.54
ROM Tonnes Hoisted	FY45	FY46	FY47	FY48	FY49	FY50	FY51	FY52	FY53	FY54
LB (Mtpa)	-	-	-	-	-	-	-	-	-	-
UB (Mtpa)	1.53	1.53	1.54	1.54	1.53	1.54	1.54	1.54	1.54	1.54
Total (Mtpa)	1.53	1.53	1.54	1.54	1.53	1.54	1.54	1.54	1.54	1.54
ROM Tonnes Hoisted	FY55	FY56	FY57	FY58	FY59	FY60	FY61	FY62	FY63	FY64-66
LB (Mtpa)	-	-	-	-	-	-	-	0.59	1.50	4.35
UB (Mtpa)	1.53	1.53	1.53	1.54	1.54	1.54	1.54	0.97	0.01	-
Total (Mtpa)	1.53	1.53	1.53	1.54	1.54	1.54	1.54	1.56	1.51	4.35

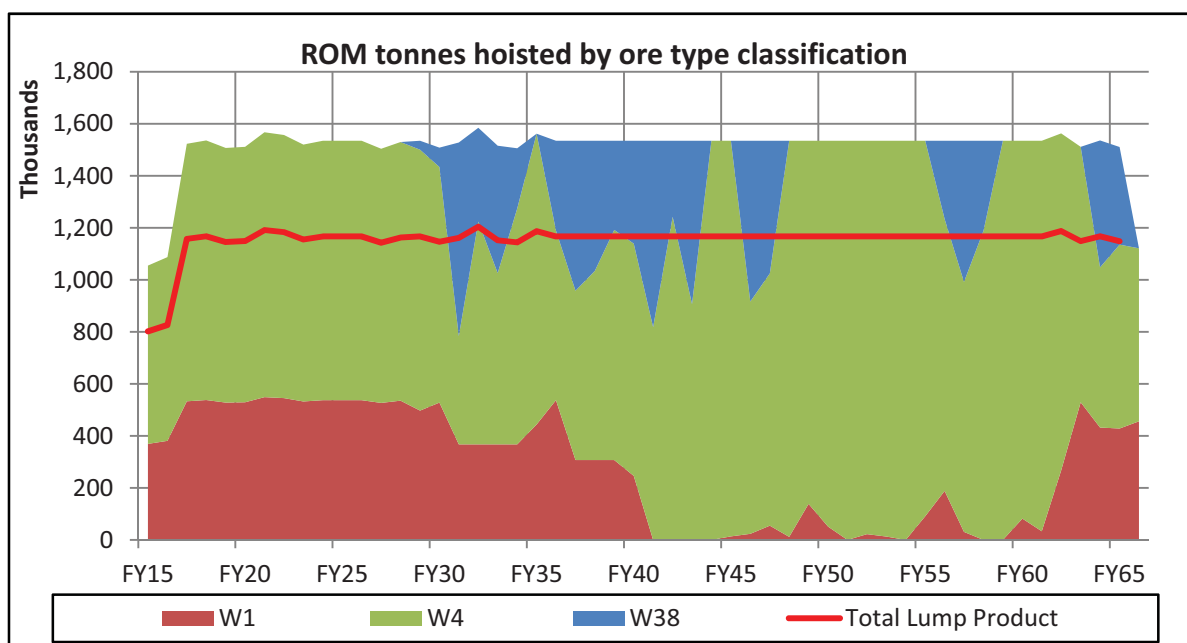

Figure 35 Tonnes hoisted by ore type classification in FY15 LoA plan

Source: Hotazel

The below cut-off grade W4L38 that is available for blending to the W4L40 can clearly be seen. It is evident that the delivery of high grade W1 products cannot be sustained throughout the LoA plan and it is reasonable to assume that the W1 product could cease to exist past FY40. Table 27 shows a summary of the ROM tonnes by ore type classification scheduled in the FY15 LoA plan.

Table 27 Summary of ROM tonnes hoisted by ore product type, based on FY15 LoA plan

Classification	FY15	FY16	FY17	FY18	FY19	FY	FY21	FY22	FY23	FY24
W1 Ore	0.37	0.38	0.53	0.54	0.53	0.53	0.55	0.54	0.53	0.54
W4L40 Ore	0.69	0.71	0.99	1.00	0.98	0.98	1.02	1.01	0.99	1.00
W4L38 Ore	-	-	-	-	-	-	-	-	-	-
Total (Mtpa)	1.06	1.09	1.52	1.54	1.51	1.51	1.57	1.56	1.52	1.54
Classification	FY25	FY26	FY27	FY28	FY29	FY30	FY31	FY32	FY33	FY34
W1 Ore	0.54	0.54	0.53	0.54	0.50	0.53	0.37	0.37	0.37	0.37
W4L40 Ore	1.00	1.00	0.98	0.99	1.00	0.91	0.42	0.86	0.66	0.91
W4L38 Ore	-	-	-	-	0.03	0.07	0.74	0.36	0.49	0.23
Total (Mtpa)	1.54	1.54	1.50	1.53	1.54	1.51	1.53	1.59	1.52	1.51
Classification	FY35	FY36	FY37	FY38	FY39	FY40	FY41	FY42	FY43	FY44
W1 Ore	0.44	0.54	0.31	0.31	0.31	0.25	-	-	-	-
W4L40 Ore	1.12	0.65	0.65	0.73	0.89	0.89	0.82	1.24	0.91	1.54
W4L38 Ore	-	0.35	0.58	0.50	0.34	0.40	0.72	0.29	0.63	-
Total (Mtpa)	1.56	1.53	1.54	1.53	1.53	1.54	1.54	1.53	1.54	1.54
Classification	FY45	FY46	FY47	FY48	FY49	FY50	FY51	FY52	FY53	FY54
W1 Ore	0.01	0.02	0.05	0.01	0.14	0.05	-	0.02	0.01	-
W4L40 Ore	1.52	0.89	0.97	1.52	1.40	1.48	1.54	1.51	1.52	1.54
W4L38 Ore	-	0.62	0.51	-	-	-	-	-	-	-
Total (Mtpa)	1.53	1.53	1.54	1.54	1.53	1.54	1.54	1.54	1.54	1.54
Classification	FY55	FY56	FY57	FY58	FY59	FY60	FY61	FY62	FY63	FY64- FY66
W1 Ore	0.09	0.19	0.03	-	-	0.08	0.03	0.27	0.53	1.32
W4L40 Ore	1.44	1.05	0.96	1.19	1.54	1.45	1.50	1.30	0.98	2.00
W4L38 Ore	-	0.30	0.54	0.35	-	-	-	-	-	1.05
Total (Mtpa)	1.53	1.53	1.53	1.54	1.54	1.54	1.54	1.56	1.51	4.37

4.4.3 Historical Production and Expenditures

Figure 36 shows the actual ROM tonnes hoisted for FY13 and FY14 in relation to the technical budgeted figures for the corresponding periods. The actual production profile indicates that the underground operation is constantly under-performing relative to the planned production targets (the red line).

Table 28 shows that for FY12 the operation hoisted 113 kt ROM ore, 11.3% less than the budget with a variance of 133 kt ROM ore recorded in the 2013 financial year. The production deficit increased to 211 kt in FY14. The FY15 LoA plan indicates planned ROM production of 1.1 Mtpa for FY15 and FY16 with a scheduled increase in production to 1.5 Mtpa from FY17. The FY17 scheduled ROM production averages 70% higher than the current mine performance. The planned increased production profile may not be achievable in the short term considering the historic mine performance and relatively short time allowed to build-up production. The bottleneck at Wessels is the hauling and this is due to the long distances from the mining faces to the underground crushers. Once the Central Block crusher is commissioned then the risk of not achieving 1.5 Mtpa reduces. This does not materially impact the Ore Reserves or the valuation, but indicates an opportunity to improve so that planned budgets are maintained.

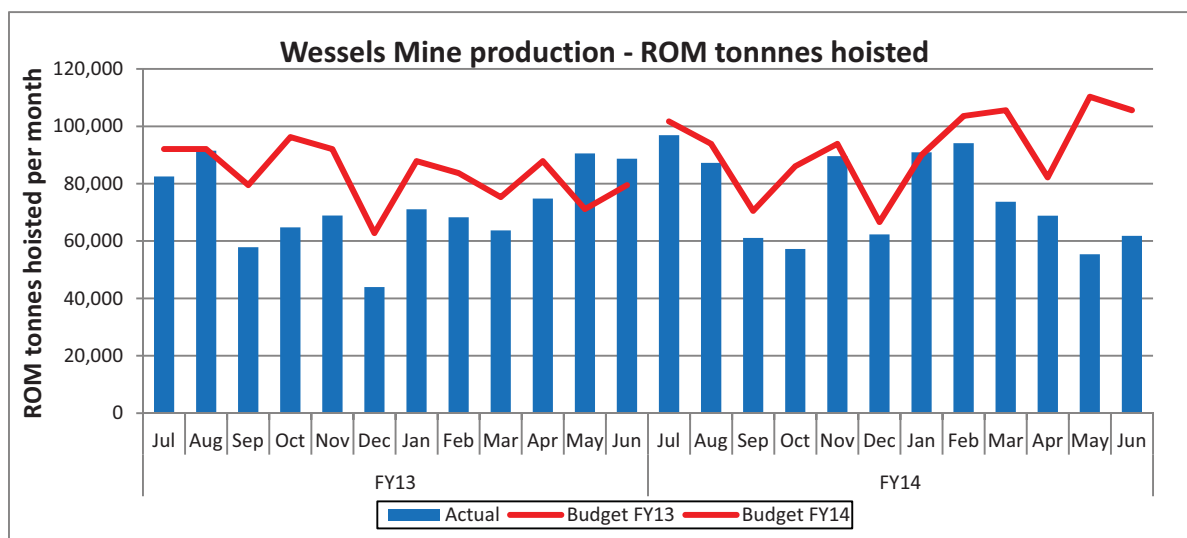

Figure 36 Wessels Mine production history showing annual actual and budget figures and that monthly actuals (blue bars) are less than monthly budgets (red line)
Source: Hotazel

Table 28 Actual vs budgeted tonnes hoisted – last three years

Wessels ROM Ore tonnes hoisted (ktpa)	FY12	FY13	FY14
Actual	887	867	899
Budget	1,000	1,000	1,110
Variance	-113	-133	-211

The historic mine nominal cash costs of production are shown in Table 29. Together with Table 28 it can be seen that production, while not meeting budget, has been increasing while C1 unit cash costs have been falling.

Table 29 Nominal cash costs of production – last three years

Wessels Mine (US\$/mtu)	FY11	FY12	FY13
Labour	0.62	0.53	0.5
Maintenance	0.28	0.22	0.18
Electricity	0.06	0.06	0.06
Fuel	0.06	0.06	0.04
Buy Ins	0.10	0.12	0.02
Infrastructure allocation	0.45	0.52	0.38
Explosives	0.02	0.01	0.01
Other Costs	0.28	0.25	0.2
Total Cash Cost (C1)	1.87	1.76	1.41

4.4.4 Wessels reconciliations

Table 30 shows the data used in the FY14 reconciliation of Mineral Resources, Ore Reserves and actual mine production, as prepared by BHP Billiton. All tonnes are reported as dry tonnes. Only Lump product is reconciled and the production data covers the period April 2013 to March 2014.

Table 30 Production data used in FY14 reconciliation

Category	Tonnes	Mn (%)	Fe (%)	Remarks
Estimated mined-out resource	1,043,148	42.2	12.2	2014 Resource depletion estimated from global resource model, using Datamine
Estimated mined-out reserve	837,539	42.0	12.2	Mined-out global reserve from MineSight model.
Estimated mined-out grade control reserve	846,051	45.0	11.6	Mined-out grade control reserve from MineSight model.
Surveyed mine movement (ROM)	856,208	45.2	11.9	Grades from FY14 silo sampling values.
Surveyed mine movement (waste)	96,360			
Backlashed underground stock	109,859	44.1	11.6	Grades from FY13 silo values. Underground stock calculated as follows: 966,067 tonnes hoisted – 856,208 tonnes actually mined = 109,859 tonnes
Tonnes ROM mined	856,208	45.2	11.9	Grades from FY14 silo sampling values.
Tonnes ROM hoisted	966,067	45.2	11.9	From cable belt weightometer. Grades from FY14 silo sampling values.
Tonnes ROM plant feed	971,527	45.2	11.9	From plant feed weightometer. Grades from FY14 silo sampling values.
Closing stock ahead of processing plant	1,891	45.2	11.9	Grades from FY14 silo sampling values.
Tonnes quality product (Lump)	741,420	45.0	12.3	ROM minus 23.7% fines and slimes factor. Grades from dispatch sampling values.
Quality product opening stock	22,426	44.9	11.8	Mn and Fe grades based on FY13 dispatch sampling values.
Tonnes sold	735,618	45.0	12.3	Mn and Fe grades based on FY14 dispatch sampling values.
Quality product closing stock	25,421	45.0	12.3	Mn and Fe grades based on FY14 dispatch sampling values.

Wessels carries out comprehensive reconciliations and analysis as shown in Figure 37. Three reconciliation processes from the above estimates are defined:

- F1 is the ratio of the grade control model with the Ore Reserve model, which is +2.2% tonnes, +3.2% Mn grade units and -0.3% Fe grade units.

- F2 is the ratio between the process received feed and that predicted by the grade control model in the period, which is 13.5% tonnes and correct grades.
- F3 is the ratio between the final sales product and that estimated from the Ore Reserve model, in **bold font** in Table 30, which is -11.5% tonnes, +3.0% Mn grade units and +0.1% Fe grade units.

An estimated 109,859 tonnes was also hoisted from underground historic stockpiles. As this was not 'mined' during the period it is not reflected in the Ore Reserve depletion.

The improved grades compared to the Ore Reserves are mainly due to high manganese grades encountered in the Central Block that are reflected in the grade control model but not in the Ore Reserve model.

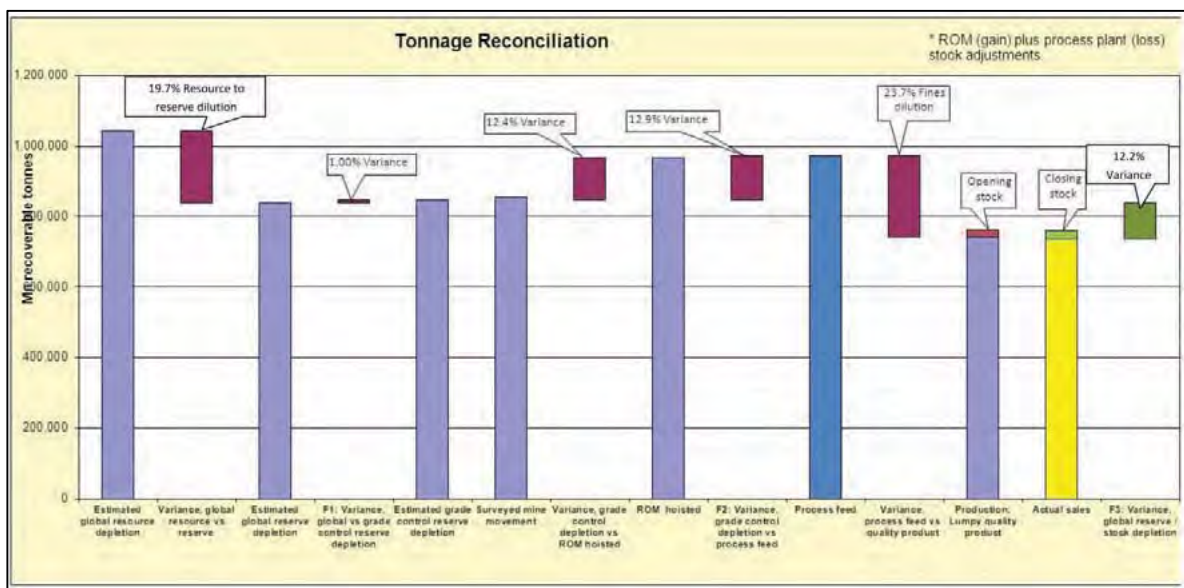

Figure 37 Wessels tonnage reconciliation – FY14
Source: Hotazel

4.4.5 Comparisons between Mamatwan and Wessels reconciliations

Comparative reconciliations over a two year period since the start of FY13 are available for both Mamatwan and Wessels and have been graphed by CSA Global to show F1, F2 and F3 for the tonnes, Mn grade and Fe grade, all as relative percentages (Figure 38). Overall these indicate reasonable conformity of the Production to Ore Reserves (F3) and the Grade Control to Ore Reserves (F1). As expected there is mostly good correlation between F2 and F3.



Figure 38 Comparative reconciliations of Mamatwan (left) and Wessels (right) showing tonnes, Mn grade and Fe grade, all in relative terms, for F1, F2 and F3.

Source: CSA Global

4.4.6 Modifying Factors

Wessels underground ROM production is driven by requirements to produce a high grade product at 47% Mn or a low grade product at 42% Mn currently and 40% Mn later in the life when the lower grade UB is scheduled. These products are achieved by implementing specific grade cut-off constraints to achieve final product requirements. A 45% Mn cut-off (referred to as a cut-over) is used for high grade ore and a 37.5% Mn cut-off is used for low grade ore. An additional 18% of ore below the stated cut-off grade of 37.5% Mn is blended with the low grade ore to deliver a lower specification product. Table 31 shows the mining Modifying Factors used to convert the Mineral Resources to Ore Reserves. Note that there is no dilution. CSA Global understands that this is due to all material removed from this underground mine being classed as ore, prior to feeding it to the plant.

Table 31 Mining Modifying Factors

Modifying Factors	West Block	Graben Block	Central Block	East Block
Geological losses	0%	0%	0%	0%
Pillar losses	25%	25%	18%	18%
Boundary pillar losses	0%	0%	0%	0%
Infrastructure losses	0%	2%	2%	0%
Ore loss	10%	10%	10%	10%

The scheduled ROM ore is converted to product tonnes by multiplying the tonnage hoisted by a Lump product factor of 76% to estimate Lump product produced, a factor of 12% to estimate the Fines product and 12% to estimate the slimes lost to the TSF.

4.4.7 Mine Schedule

Much (68%) of Wessels remaining underground mine production is scheduled from the UB. A geotechnical study was conducted in 2007 to investigate the opportunity for multi-layer ore extraction. The study indicated that a majority of the UB located in the East and Central Blocks would be extractable but only 60% of the West Block is recoverable due to a middling (inter-layer) thickness of less than 10 m. The UB was converted to an Ore reserve based on a Life of Mine plan developed in-house.

CSA Global Assessment

Figure 39 shows the estimated middling thickness between the Upper and Lower Bodies with the current mine design superimposed. The areas in orange have a middling thickness of 10 m to 12 m and may require monitoring during mining. The areas in red have a middling thickness less than 10 m rendering extraction of the UB problematic. These areas have been excluded by CSA Global from the FY15 LoA plan as the basis of the Ore Reserve estimate. However these tonnages are compensated for by equivalent tonnages at lower cut-off grades that have been included by Wessels Mine in their LoA plan to meet optimum product specifications.

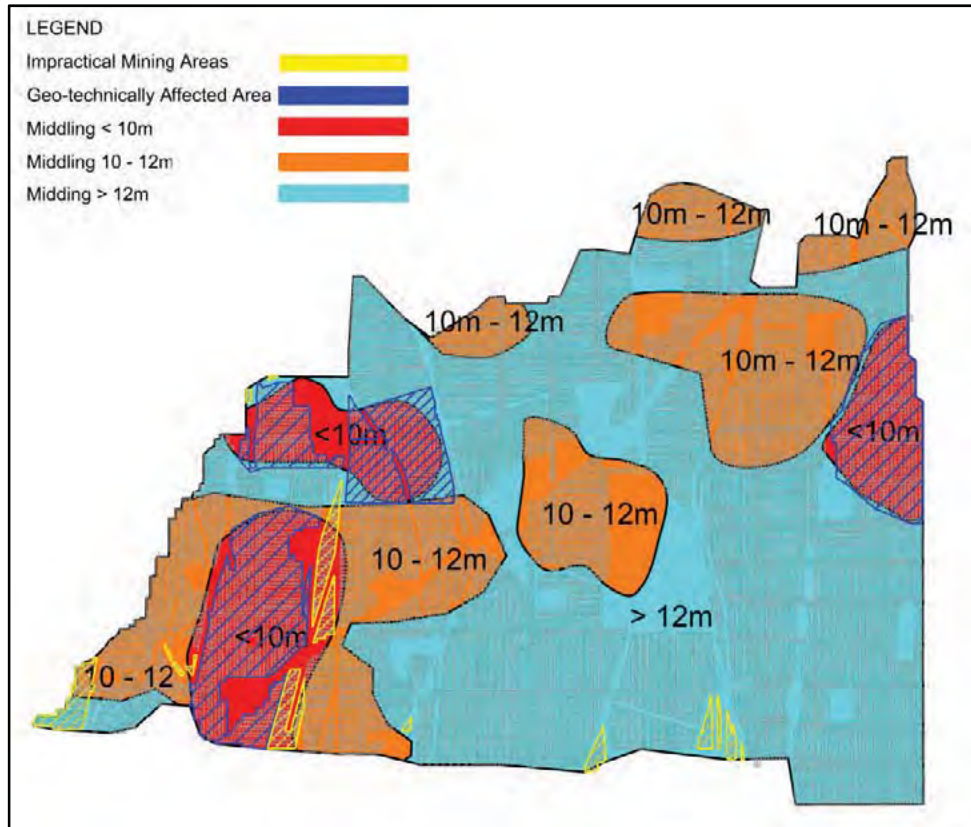

Figure 39 Mining areas influenced by middling (inter-layer) thicknesses of less than 10 m
The areas with thickness of 10 to 12 m may require monitoring during mining
 Source: CSA Global

Figure 40 shows the contribution of the mined material below the ore cut-off grade in the FY15 LoA plan. This material accounts for 18% of the total reported Ore Reserve for Wessels mine. This material is blended with the W4L40 material to create a product specification of minimum 40% Mn.

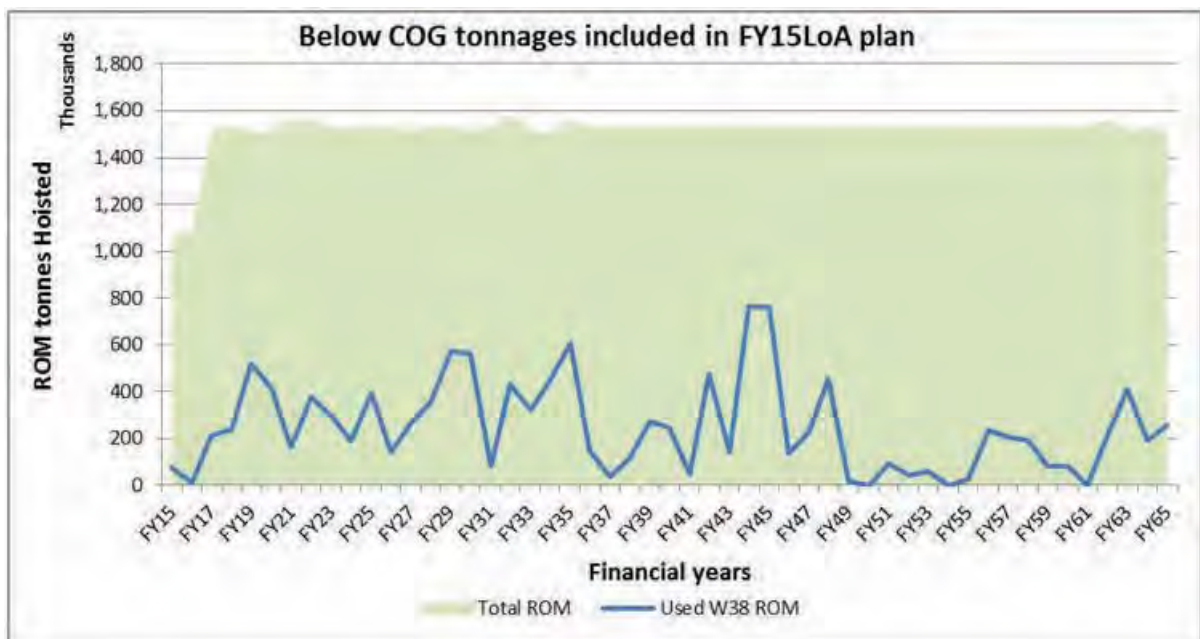

Figure 40 Below COG ore included in the Life of Mine plan

The LB of the Graben Block is currently scheduled at the end of the mine life at a production rate of 1.5 Mtpa. A reschedule of this area is envisaged to precede development of the UB in the Graben block for geotechnical reasons and to maintain the 1.5 Mtpa overall underground production rate. Historical production shows that a mining rate not exceeding 0.6 Mtpa should be assumed where production is coming from a single production area such as the Graben Block.

4.4.8 Risks – Wessels Mine

CSA Global Assessment

The risks to the sustained production at an optimised cost profile can be summarised as follows:

- The UB is included in the Ore Reserve statement for Wessels Mine and accounts for approximately 68% of the reported ROM tonnages in the FY15LoA plan. In CSA Global's view a detailed design study is yet to be conducted and is required.
- With the Graben Block scheduled at the end of the life of the operation, it is unreasonable that 1.5 Mtpa can be maintained. Previous formal conceptual studies were conducted at a much lower Graben Block production rate. It has not been demonstrated that the Graben Block adds value at low rates as a standalone operation, based on the current schedule and mine configuration.

4.4.9 Wessels Ore Reserves Statement

Table 32 provides the forecast Ore Reserve at 31 December 2014 relative to the Competent Person statement at 30 June 2014. The changes are due to mining depletion. The Ore Reserve includes 18% of ore below the stated cut-off grade of 37.5% Mn. CSA Global considers that there is sufficient likelihood that this material will be recoverable and saleable for it to be included in the Ore Reserve as Probable Ore.

Table 32 Ore Reserve depletion – June 2014 to December 2014

Wessels Mine	30 June 2014			31 December 2014			Half Year FY15 Production			Variance
	Tonnes (Wet Mt)	Mn (%)	Fe (%)	Tonnes (Wet Mt)	Mn (%)	Fe (%)	Tonnes (Wet Mt)	Mn (%)	Fe (%)	Tonnes (Wet Mt)
Proved	3.4	43.7	12.0	2.9	43.8	11.9	0.5	42.7	12.6	-0.5
Probable	66.1	42.2	16.6	66.1	42.2	16.6				
Total	69.5	42.2	16.4	69.0	42.2	16.4	0.5	42.7	12.6	-0.5

The FY15 half year production figures in Table 32 include actual mine production for July to September 2014 with forecast production figures used for October to December 2014.

The Ore Reserves for Wessels Mine have been examined and validated by CSA Global under the JORC Code (2012). CSA Global accepts the Ore Reserves stated by Hotazel at 30 June 2014 and has depleted them to 31 December 2014. The Wessels Ore Reserves estimate based on the CP FY14 report and the FY15 LoA plan, depleted to 31 December 2014 is shown in Table 33. The Measured Mineral Resource blocks were converted to Proved Ore Reserve and the Indicated Mineral

Resource blocks to Probable Ore Reserve. The Mineral Resource is inclusive of the Ore Reserve. The tonnage is reported as wet metric tonnes.

Table 33 Wessels Mine Ore Reserves estimate at 31 December 2014

Wessels Mine	Proved			Probable			Total		
Area	Tonnes (Wet Mt)	Mn (%)	Fe (%)	Tonnes (Wet Mt)	Mn (%)	Fe (%)	Tonnes (Wet Mt)	Mn (%)	Fe (%)
UB				46.2	41.4	18.2	46.2	41.4	18.2
LB	2.9	43.8	11.9	19.9	43.9	12.9	22.8	43.9	12.8
Total	2.9	43.8	11.9	66.1	42.2	16.6	69.0	42.2	16.4

A nominal cut-off grade of 37.5% Mn is used to define mineable ore blocks but material below the cut-off grade is included where it produces a saleable blended product.

5 Valuation of Ore Reserves

5.1 Valuation Methodology

The Code for the Technical Assessment and Valuation of Mineral and Petroleum Assets and Securities for Independent Experts Reports (VALMIN) sets out guidelines for the valuation of mineral properties. The VALMIN Code (2005) classifies mineral assets into categories which represent a spectrum from Exploration Areas where mineralisation may or may not have been identified through to Operating Mines (mineral properties, particularly mines and processing plants that have been commissioned and are in production). Under the current ASX listing rules, Operating Mines of public companies are expected to have an Ore Reserve reported under the JORC Code (2012).

Different valuation methodologies may be applied but regardless of the technique employed, consideration must be given to the perceived 'fair market valuation'. This is described in the VALMIN Code under Definition 43:

"Value is the Fair Market Value of a Mineral or Petroleum Asset or Security. It is the amount of money (or the cash equivalent of some other consideration) determined by the Expert in accordance with the provisions of the VALMIN Code for which the Mineral or Petroleum Asset or Security should change hands on the Valuation Date in an open and unrestricted market between a willing buyer and a willing seller in an 'arm's length' transaction, with each party acting knowledgeably, prudently and without compulsion."

CSA Global was commissioned to provide an independent Valuation of the Ore Reserves of Hotazel, to fulfil the requirements of the ESMA Recommendations.

The open pit Mamatwan Mine commenced operations in 1964 and the underground Wessels Mine in 1973. Both mines have been the subject of extensive Mineral Resource definition drilling, and ongoing production, resulting in well-established Ore Reserves and robust LoA plans. These have been assessed in detail to verify the technical soundness and economic viability of future mining operations.

For valuation, the use of differing methodologies has been considered and the discounted future cash flow (DCF) method has been selected as the most appropriate for valuing the Hotazel Ore Reserves.

5.2 Manganese Market and Outlook

Approximately 75% of the manganese product produced by Hotazel is exported to the international ferro-alloy market, with the remainder sold to Samancor Manganese Metalloys (Metalloys) owned by Manganese South Africa.

Manganese products (sinter, Lump and Fines ores) are sold by Hotazel to Metalloys under a 'cost plus' supply agreement. Manganese sold into the international market is priced on short-term or spot contracts, with prices linked to published indices. The commodity is not exchange traded, and prices are largely determined by supply and demand forces. Ore is priced on a dry metric tonne unit (dmtu) basis and referenced to a benchmark ore of 44% Mn cost insurance freight (CIF).

Historically, manganese ore has traded at levels around US\$2.00/dmtu with little price volatility, until rising in 2005 with further significant price rises in 2007, before reaching a monthly peak of US\$18.40/dmtu in 2008 for medium grade Lump ore CIF China.

With a tightening in the global market balance due to a combination of rapid growth in global demand for manganese against a backdrop of tight supply, global demand reached new records as smelting facilities worldwide ramped up output to new highs and China's demand for imports rose significantly. This resulted in pressure on the supply chain, which was already at full capacity.

As a result of the global financial crisis, earlier gains in manganese ore prices were eroded and prices fell to a floor of around US\$3.50/dmtu in May 2009. A swift return of Chinese import demand and a gradual recovery in alloy production around the world underpinned a recovery in prices in late 2009 to 2010. Since then, prices have tracked a declining, or at times steady, path.

Most recently (2014 H1) manganese ore prices have fallen sharply from \$5.70/dmtu to \$4.35/dmtu (Table 34).

Table 34 Annual average manganese prices for the 44% SL Mn benchmark

		2007	2008	2009	2010	2011	2012	2013	2014
Annual average price 44% Mn Lump, CIF China	US\$/dmtu	5.67	14.38	5.32	7.33	5.46	4.93	5.43	4.59

5.3 Cash Flow Modelling and Assumptions

Hotazel has developed comprehensive and detailed cash flow models based on their declared Ore Reserves at 30 June 2014. CSA Global has conducted checks and analysis of these models and found them to be a reasonable basis for Valuation of the Assets for the purposes of this report. The integrity of the cash flow models was checked as follows:

- Review of model detail, underlying assumptions and outputs with the model developers in Johannesburg.
- Review of the model change log sheets over a 12 month period and NPV change documentation which was reconciled to the Manganese South Africa FY15 LoA plan.
- Independent review by CSA Global of model underlying assumptions, key drivers and outputs.
- External modelling by CSA Global of the key drivers and inputs demonstrating agreement between the model provided and this external model within $\pm 5\%$.

CSA Global has used the base of the FY15 LoA plan and strategic cash flow model to develop a valuation model for the Hotazel mining operations and to assess the sensitivity of the project value to changes in key assumptions. CSA Global is satisfied with the integrity and operational assumptions contained within these models and has undertaken an external assurance process to ensure that the model is suitable for use in this report.

Key assumptions relating to manganese ore pricing, foreign exchange rates, and discount rates were independently determined by CSA Global and ungeared post-tax cash flows as at a valuation date of 31 December 2014 were discounted to derive a range of present values.

Key assumptions adopted by CSA Global in deriving a base case value for Hotazel are provided in Table 35 with parameters specific for Mamatwan and Wessels highlighted separately.

Table 35 Key assumptions in deriving a Base Case value for the Hotazel Ore Reserves

Input parameter	Amount	Unit	Source
Corporate tax rate	28	%	South African corporate tax rate
Real discount rate	10.0 to 11.0	%	BHP Billiton weighted average cost of capital (WACC) + 3% South African Country Risk
Long Term Mn Ore 44% SL Mn Benchmark CIF China	5.34	US\$/dmtu	CRU International October 2014 Mn Ore Market Outlook
Mamatwan			
Long term foreign exchange rate	13.3	ZAR/US\$	Current November 2014 rate and South Africa Economic Outlook, extending over life of mine (17.5 years)
Capital cost	408	US\$ M	Hotazel
Total closure cost	126	US\$ M	Hotazel
Plant throughput	3.3	Mtpa	Hotazel
LoA Mn ore sales	43.4	Mt	Hotazel, from Valuation Date 31 December 2014 to end
Wessels			
Long term foreign exchange rate	13.9	ZAR/US\$	Current November 2014 rate and South Africa Economic Outlook, extending over life of mine (46.5 years)
Capital cost	1161	US\$ M	Hotazel
Total closure cost	43	US\$ M	Hotazel
Plant throughput	1.2	Mt	Hotazel
LoA Mn ore sales	65	Mt	Hotazel, from Valuation Date 31 December 2014 to end

Mamatwan parameters in blue rows and Wessels in yellow rows

5.3.1 Commodity Pricing Assumptions

Assumptions regarding commodity pricing were made having regard to the manganese ore and manganese alloy market outlook to 2018 as well as historical pricing trends. Current analysis of the manganese alloy sector indicates that margins and profitability of alloy producers is likely to remain steady over the period 2015 to 2018 due to market balances (CRU, 2014).

The short term outlook for manganese ore in 2015 H1 is for a continuing period of product oversupply with stocks at major Chinese ports remaining high. This will continue to provide pressure on manganese ore prices in the short term.

The medium term outlook through 2016 and 2017 for the manganese ore market is for supply and demand to be mainly balanced, with increased import demand from China. This increased import demand is expected to result from reduced Chinese domestic production of manganese ore on the back of declining ore grades and rising costs due to more difficult mining conditions at their operations. This assumption is central to forecasts of prices rising, but not far from current levels, based upon the volume of Chinese manganese ore required in the market.

It is anticipated that where possible, China will import higher quality and potentially lower cost manganese ore from abroad, leading to a rising dependency on imports in the years ahead, with marginal Chinese production underpinning rising prices through to 2018.

Following a review of commodity research data from CRU International Limited, publicly available information, and market conditions described above, CSA Global has derived manganese ore prices of US\$4.59/dmtu for the remainder of FY15, rising to US\$4.90/dmtu in FY16, US\$5.09/dmtu in FY17, and a long term price of US\$5.49/dmtu thereafter (Figure 41).

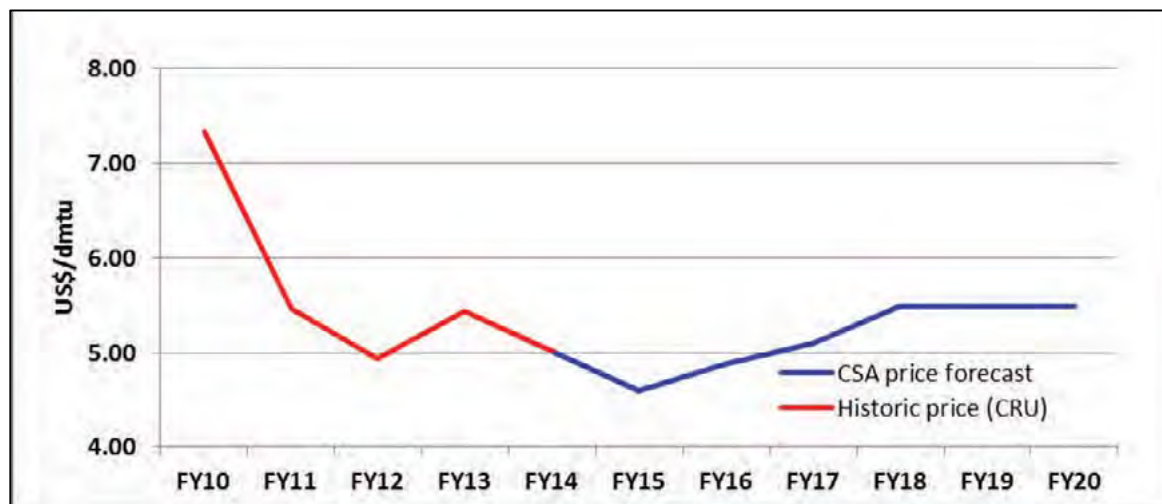

Figure 41 CSA Global forecast of Mn prices

5.3.2 Exchange Rate Assumptions

The South African Rand (ZAR) to US Dollar (US\$) exchange rate forecast has been derived using the current exchange rate at 19 November 2014 (11.05) and the outlook for a strengthening US dollar, following the 29 October 2014 announcement by the US Federal Reserve regarding the conclusion of its bond-buying program (quantitative easing). Current expectations in financial markets are for the US Federal Reserve to commence interest rate rises before the end of 2015.

The ZAR/US\$ exchange rate has been volatile in 2014. At the start of 2014 it rapidly weakened from 10.48 to 11.29 in less than a month. However, this decline in the Rand had commenced over a year earlier, in August 2012, following the tragic shooting of striking workers at the Marikana platinum mine.

This proved a critical point for the South African economy and for the Rand, because GDP growth dropped from 3.6% year on year in 2011 to 2.5% in 2012 and 1.9% in 2013. GDP growth is likely to deteriorate further in 2014 to 1.6% due to the impact of escalating strike action. Negative investor sentiment and global risk aversion, has seen the Rand weaken relative to the US\$ from 8.07 in August 2012 to current levels, and inflation rise from 4.9% to 6.6% in mid-2014. The rand was last at its purchasing price parity, or fair value, in the first half of 2012, when interest rates were relatively stable. The increase in the incidences of labour market instability and the destructive and disruptive impact of prolonged, violent strike action since the second half of 2012 have contributed to the deterioration in South Africa's economic performance.

Based on this backdrop, in June 2014 Standard and Poor's Financial Services downgraded South Africa's sovereign long-term foreign currency rating to BBB-, citing "expectation of lacklustre GDP growth in South Africa, against a backdrop of relatively high current account deficits, rising general government debt, and the potential volatility and cost of external financing".

Further, in a 2014 fourth quarter review and outlook for emerging markets, Brown Brothers Harriman Foreign Exchange note that fundamentals in South Africa continue to worsen. The current

account gap widened to -6.2% of GDP in Q2 2014, and continued weakness in exports and commodity prices suggests further upward pressure on the external deficits.

CSA Global has determined that, given the factors outlined above, a ZAR/US\$ exchange rate of 11.05 for the remainder of FY15 is appropriate. Thereafter, a rise is forecast of 0.25 year on year for FY16 and FY17, a rise of 0.37 in FY18, and a rise year on year of 0.40 from FY19 to FY24; with a long term exchange rate of 14.32 from FY24.

A graph of the historical and CSA Global's forecast ZAR/US\$ exchange rate data is presented in (Figure 42).



Figure 42 Historical and forecast ZAR/US\$ exchange rates

5.3.3 Discount Rate Determination

The rate used to discount future cash flows to determine the NPV for valuation should represent the required market rate of return for capital invested in the project being valued.

The expected rate of return for invested capital is generally determined using the weighted average cost of capital (WACC) approach using market evidence from comparable sector companies. It is derived on a post-tax real basis.

In calculating a WACC for the Hotazel investments of BHP Billiton, CSA Global used the following inputs, since BHP Billiton's primary listing is on the ASX:

- Risk free rate of 3.3% being the Australian Government 10 year bond yield
- Market risk premium of 8.1% from the Independent Pricing and Regulatory Tribunal (IPART) August 2014 WACC update
- Debt Margin of 2.2% from IPART
- Australian inflation rate of 2.3% from the Reserve Bank of Australia (RBA)
- BHP Billiton Debt to Equity ratio of 0.41 from BHP Billiton 2014 Annual Report 2014
- BHP Billiton equity beta of 1.21 from BHP Billiton November 2014 share price

These inputs derive a post-tax real WACC of 7.5% which CSA Global has adopted as a base case discount rate.

The Organisation for Economic Co-operation and Development (OECD) publishes a country risk classification which may be used as a guide to the assessment of a country risk premium rate. South Africa's classification in 2014 has remained unchanged at 3, however ratings agencies have downgraded South Africa's credit rating in 2014 in the context of a worsening growth outlook, rising government debt and high deficits on the current account.

A country risk premium rate of 2.5% to 3.0% is comparable with the current OECD classification and rating agencies credit ratings. Having regard to the ongoing economic uncertainty in South Africa, CSA Global has applied a country risk premium rate of 3% to the discounting of future cash flows.

Combining the WACC of 7.5% and a country risk premium of 3%, results in a base case discount rate of 10.5%.

In order to model the sensitivities of the NPV to changes in discount rate, the NPV was also modelled at 10.0% and 11.0%.

5.3.4 Royalties and Taxes

The following comprise the majority of taxes and fees payable to the government under Republic of South Africa legislation:

- Corporate income tax of 28%
- Royalty rate for unrefined minerals is a percentage determined by Section 4 of the Republic of South Africa - Mineral and Petroleum Resources Act (2008), calculated to a maximum of 7% pa using the following formula:

$$\text{Royalty} = 0.5 + [\text{EBIT}/\text{Gross Sales} * 9] * 100$$

5.4 Mamatwan Asset Valuation

5.4.1 Mamatwan Ore Production Physicals

The Ore Reserves at 31 December 2014 were determined by depleting the 30 June 2014 Ore Reserves by actual and forecast production since that date. The Valuation was developed by depleting the FY15 scheduled ore by the same amount. Ore Reserves for Mamatwan are 62.2 Mt at 37.3% Mn as at 31 December 2014.

The current production schedule is detailed in Figure 43.

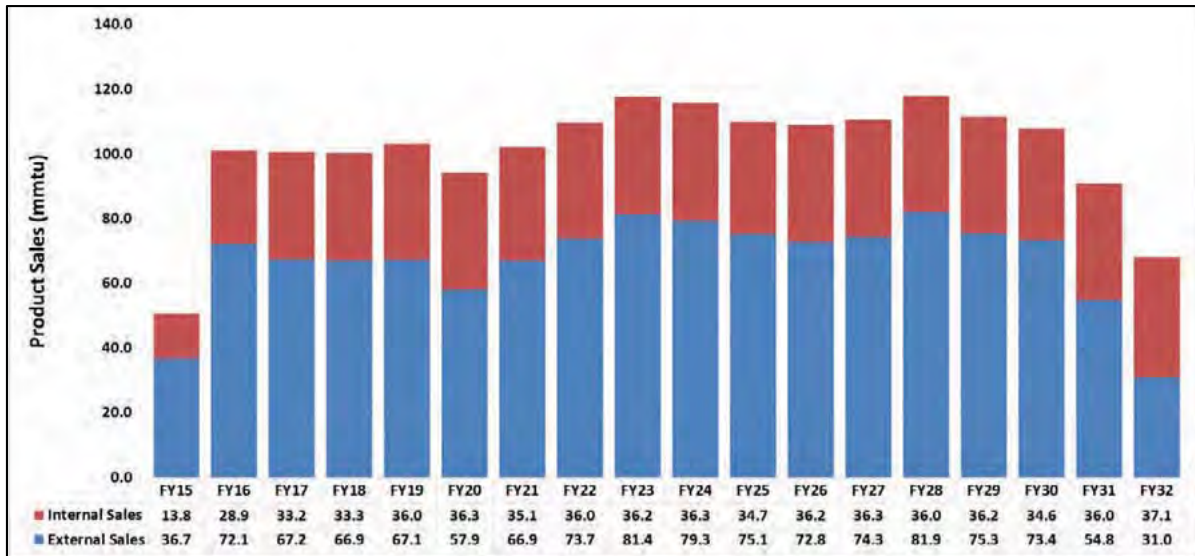

Figure 43 Mamatwan ore production summary

5.4.2 Mamatwan Operating Costs

Operating costs were derived based on the assumptions in the PVR. Figure 44 shows that the total operating cost of manganese produced drops from US\$2.03/mtu in FY16 to US\$1.58/mtu in FY24 and is then relatively constant to the end of the mine in FY32. This trend is primarily related to the depreciating Rand with the forecast exchange rate rising over this period to FY24 and a constant long term rate thereafter to FY32 (see Figure 42).

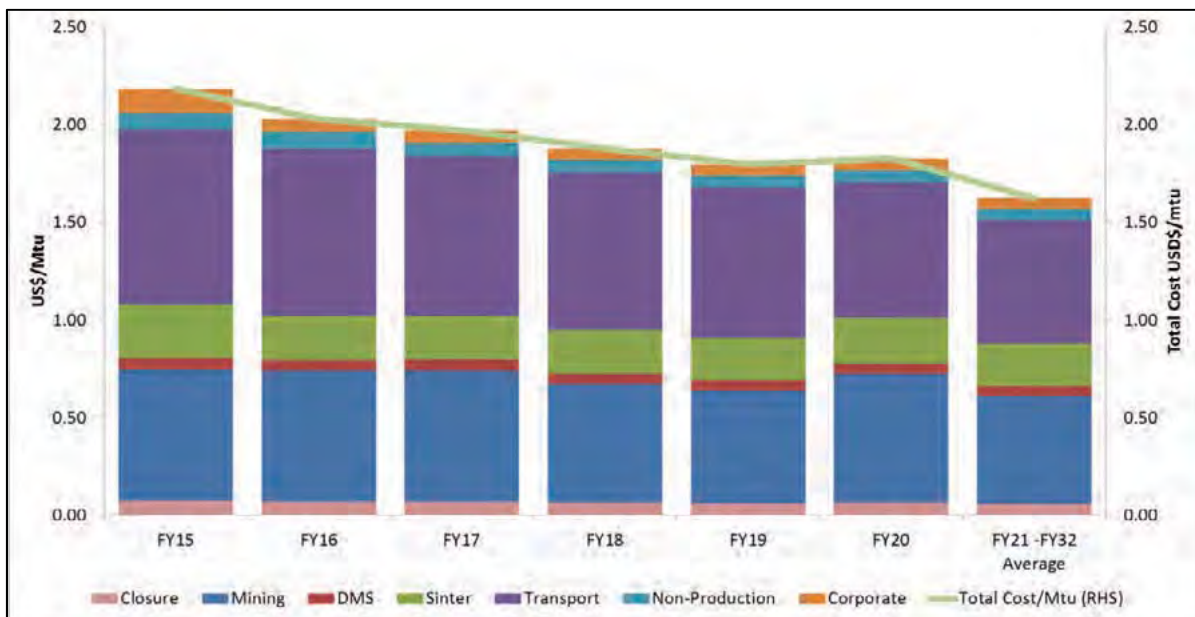

Figure 44 Mamatwan cash costs

5.4.3 Mamatwan Capital Costs

Capital costs of US\$367M are primarily related to sustaining capital of US\$329M (Figure 45).

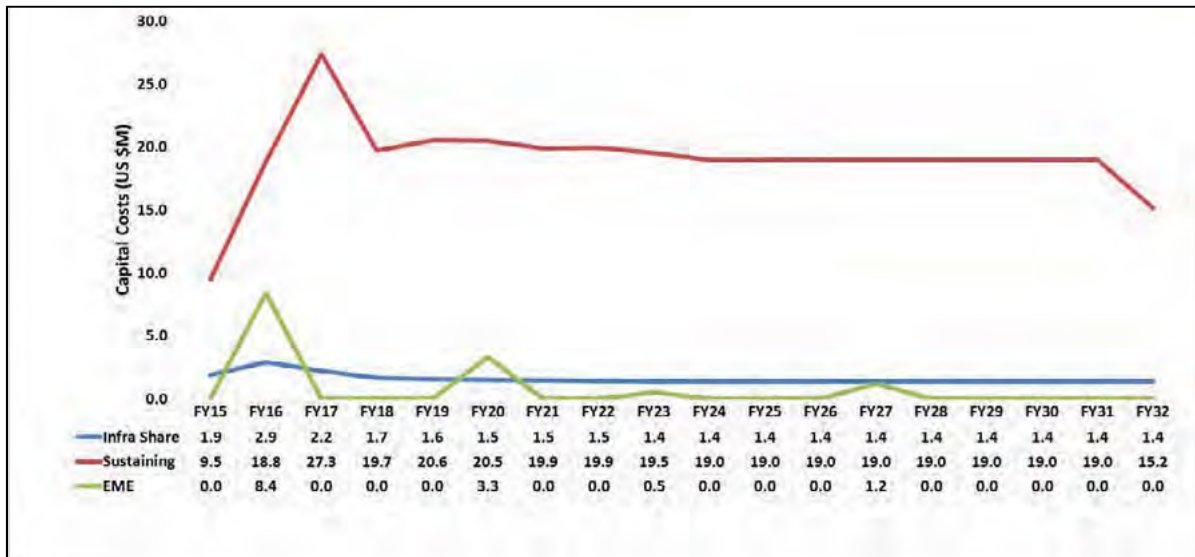

Figure 45 Mamatwan capital costs

5.4.4 Mamatwan Undiscounted Cash Flows – Base Case

The profile of undiscounted cash flows over the current Life of Asset is provided in Figure 46.

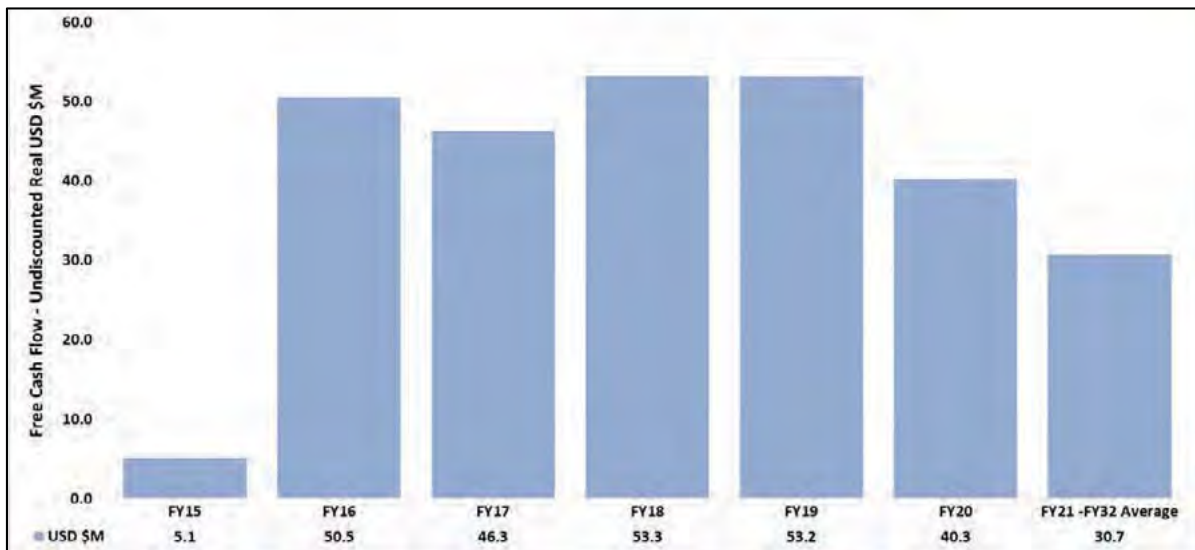

Figure 46 Mamatwan undiscounted cash flows – Base Case

5.4.5 Mamatwan NPV Valuation – Base Case

Using the key input assumptions described above as the Base Case, CSA Global has derived an ungeared, after-tax NPV of US\$587M for 100% of the Mamatwan Ore Reserves over the remaining mine life of 17.5 years from 31 Dec 2014 until 30 June 2032, the end of FY32 (Table 36).

Table 36 Base case value for Mamatwan Asset over the Life Of Mine to end of FY32

Item	Units	Amount
PHYSICALS		
Ore Reserve tonnes (wet)	Mt	62.2
Ore Reserve grade (recovered)	% Mn	37.3
Ore Reserve Yield	%	63.6
Total mine operating costs	US\$ M	2,938
Total unit operating costs	US\$ /mtu	1.75
Capital costs	US\$ M	367
Closure costs	US\$ M	109
Mine life	years	17.5
Discount rate	%	7.5
South Africa Country Risk Premium	%	3.0
NPV	US\$ M	587

5.4.6 Mamatwan NPV Valuation – Range Analysis

Keeping the quantitative physicals (tonnes, grades and costs) the same, the Base Case assumptions were varied to reflect the economic performance of the project under lower and higher commodity prices and exchange rates.

The long term benchmark Mn ore price was varied from the base case by $\pm 10\%$, as was the ZAR/US\$ exchange rate. When combined with discount factors derived from the after-tax real WACC of between 7.0% and 8.0%, and a South Africa country risk premium of 3%, a value range for 100% of the project was determined. The Base Case and Range NPVs are presented in Table 37, also showing the 44.4% share of Mamatwan that is owned by BHP Billiton.

Table 37 Range analysis of the Mamatwan Asset value over the Life Of Mine to end of FY27

Input parameter	Units	Lower	Base	Upper
Long Term ore price 44% SL Mn Benchmark CIF China	US\$/dmtu	4.81	5.34	5.88
Long Term Exchange Rate	ZAR/US\$	12.0	13.3	14.6
Real Discount Rate + County Risk	%	11.0	10.5	10.0
After-tax NPV	US\$ M	324	587	854
BHP Billiton share (44.4%)	US\$ M	144	261	379

5.4.7 Mamatwan Sensitivity Analysis

Tornado diagrams are used for deterministic sensitivity analysis to show the relative importance of input variables. Each of these are modelled separately while all other variables are held at the Base Case values. For the input parameters in Figure 47, optimistic and pessimistic values were selected to describe the reasonable sensitivity range over which these inputs might vary. It can be seen that

the project is most sensitive to changes in the foreign exchange rate and revenue (due to the commodity price).

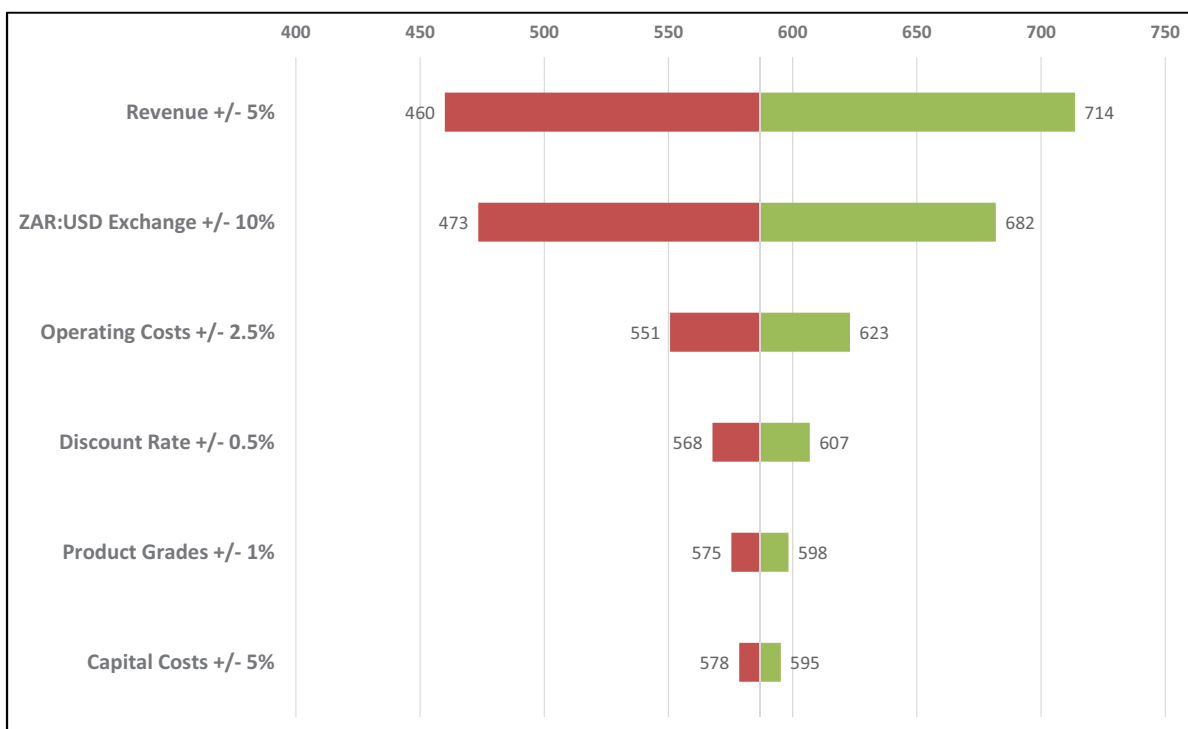

Figure 47 Mamatwan tornado diagram of sensitivities of Base Case to key drivers (US\$ M)

The most impact on variance is due to the revenue. However the exchange rate variance was used in the sensitivity analysis as Hotazel sales to the Metalloys smelter are under a 'cost plus' contract, so independent of the Benchmark commodity price. A number of two variable sensitivity analyses were thus performed, whereby each of the other inputs was varied with Revenue, holding all other inputs at their Base Case values. These are presented in Figure 48 to Figure 52 in order of their impact as shown in the tornado diagram (Figure 47). Each of these shows the impacts on NPV over the variation range with the Base Case NPV in blue, the lowest in red and the highest in green.

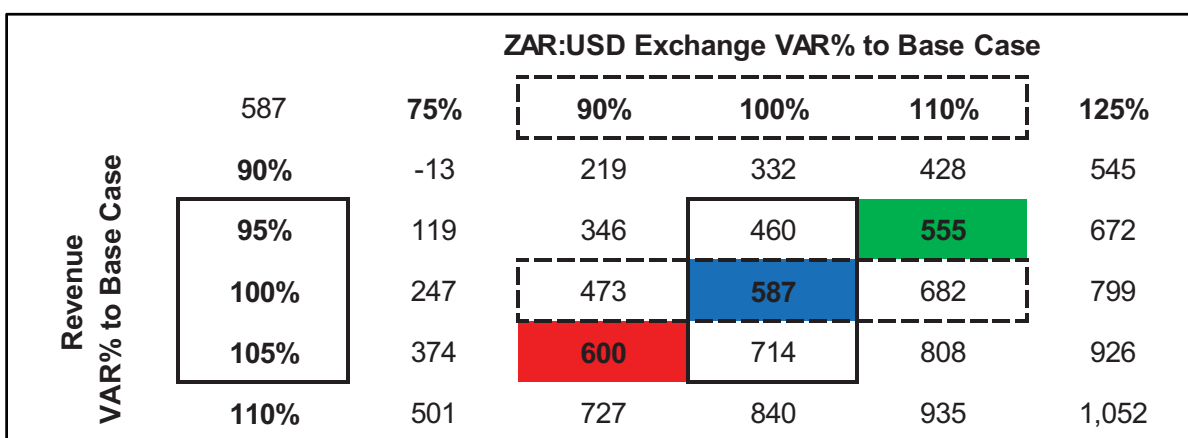

Figure 48 Mamatwan revenue and exchange rate variance to Base Case

		ZAR:USD Exchange VAR% to Base Case				
		90%	100%	110%	125%	
Operating Costs VAR% to Base Case	587	75%	633	732	814	916
	90%	438	633	732	814	916
	98%	295	513	623	715	828
	100%	247	473	587	682	799
	103%	199	433	551	649	770
	110%	53	313	442	549	681

Figure 49 Mamatwan operating costs and exchange rate variance to Base Case

		ZAR:USD Exchange VAR% to Base Case				
		90%	100%	110%	125%	
Discount Rate VAR% to Base Case	587	75%	589	724	837	977
	8%	320	589	724	837	977
	10%	258	490	607	705	825
	11%	247	473	587	682	799
	11%	237	457	568	660	774
	13%	210	413	515	601	706

Figure 50 Mamatwan discount rate and exchange rate variance to Base Case

		ZAR:USD Exchange VAR% to Base Case				
		90%	100%	110%	125%	
Product Grades VAR% to Base Case	587	75%	445	558	653	770
	98%	218	445	558	653	770
	99%	236	462	575	670	787
	100%	247	473	587	682	799
	101%	259	485	598	694	811
	103%	276	502	616	711	829

Figure 51 Mamatwan product grade and exchange rate variance to Base Case

		ZAR:USD Exchange VAR% to Base Case				
		90%	100%	110%	125%	
Capital Costs VAR% to Base Case	587	75%	492	604	697	813
	90%	269	483	595	690	806
	95%	258	473	587	682	799
	100%	247	464	578	674	792
	105%	236	455	570	666	785
	110%	225				

Figure 52 Mamatwan capital costs and exchange rate variance to Base Case

5.4.8 Mamatwan Project Opportunities

Opportunities exist which have been the subject of studies by Hotazel.

Production Profile

A study is currently underway to examine the economic benefits of extracting and stockpiling the Top Cut horizon which is currently considered uneconomic except for the X Zone (see Section 3.4.1). Should this study determine the economic viability of this material, it will add value to the Asset.

5.4.9 Mamatwan Valuation Summary

CSA Global has determined a Valuation for the Mamatwan Asset of BHP Billiton based upon the stated Ore Reserves at 31 December 2014. A range of sensitivities relating to commodity price, the ZAR/US\$ exchange rate and discount rate were undertaken on the cash flow model. CSA Global considers the ranges selected are representative of a range of reasonable outcomes for these key assumptions over the life of the Asset. The Base Case Value determined by CSA Global for BHP Billiton's 44.4% share of the Mamatwan Asset is US\$261 million. The Mamatwan Mine has an expected mine life of 17.5 years to the end of FY32.

CSA Global considers that opportunities exist which will realise additional value above that presented as the Base Case Valuation of the Ore Reserve, however these opportunities are limited with regard to producing a material uplift to the Valuation. In terms of the VALMIN Code, the Base Case NPV is a Technical Value derived from a static cash flow model, rather than a Market Value. In CSA Global's opinion the Technical Value fairly represents the Market Value for the Mamatwan Asset.

The Market or Fair Value for 100% of the Mamatwan Asset based on the Ore Reserves is therefore expected to lie in the range from US\$324M to US\$854M, with a most likely value of US\$587M. BHP Billiton's 44.4% share, rounded to an appropriate level of precision, is valued in the range from US\$140M to US\$380M with a most likely value of US\$260M.

This valuation is reflective of Hotazel's mining operations at the Mamatwan Mine, based on CSA Global's view in relation to manganese Ore Reserves only. It is important to emphasise that this value does not represent the value of the Ore Reserves in the ground in isolation, but incorporates

the value of all ungeared net assets contributing to the project based on the Ore Reserve production profile. At Mamatwan Mine this includes the value of the mining equipment fleet, beneficiation plant, sinter plant, rail load out and all other supporting infrastructure as well as the mine, over the projected Life of Asset.

5.5 Wessels Asset Valuation

5.5.1 Wessels Ore Production Physicals

The Ore Reserves at 31 December 2014 were determined by depleting the 30 June 2014 Ore Reserves by actual and forecast production since that date. The Valuation was developed by also depleting the FY15 scheduled ore by the same amount. Ore Reserves for Wessels are 69 Mt at 42.2% Mn at 31 December 2014.

The FY15 LoA production schedule extends out to FY66 but includes some lower-grade material (9.1 Mt of W4L38 product) below the cut-off grade of 37.5% Mn (see Section 4.4.2). For the Valuation by CSA Global this material was excluded resulting in a mine life of 46.5 years until 30 June 2061, the end of FY61.

The derived production schedule is detailed in Figure 53. It is assumed that all product is sold externally after the end of FY29 when the current 'cost plus' supply agreement between Hotazel and the Metalloys smelter finishes.

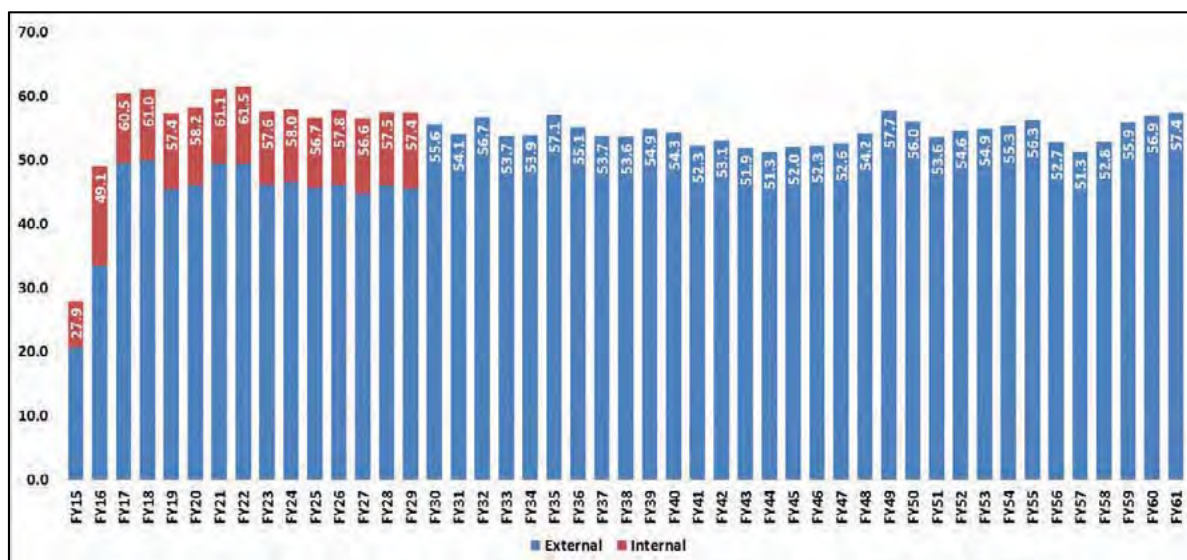

Figure 53 Wessels ore production summary

5.5.2 Wessels Operating Costs

Operating costs were derived based upon the assumptions contained in the PVR. It can be seen from Figure 54 that the total operating cost of manganese produced rises to US\$1.91/mtu in FY31 and is then relatively constant to the end of the mine in FY61. This is primarily related to higher rail volumes allocated to Wessels following the closure of the Mamatwan Asset.

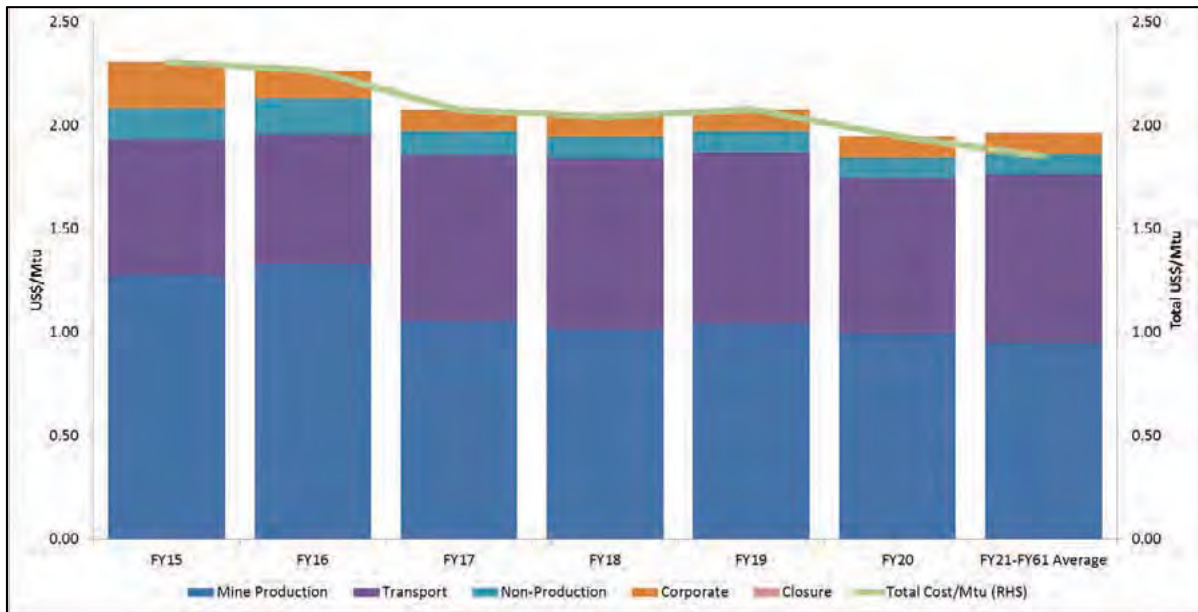

Figure 54 Wessels operating costs

5.5.3 Wessels Capital Costs

Capital costs of US\$950M are primarily related to sustaining capital of US\$851M (Figure 55).

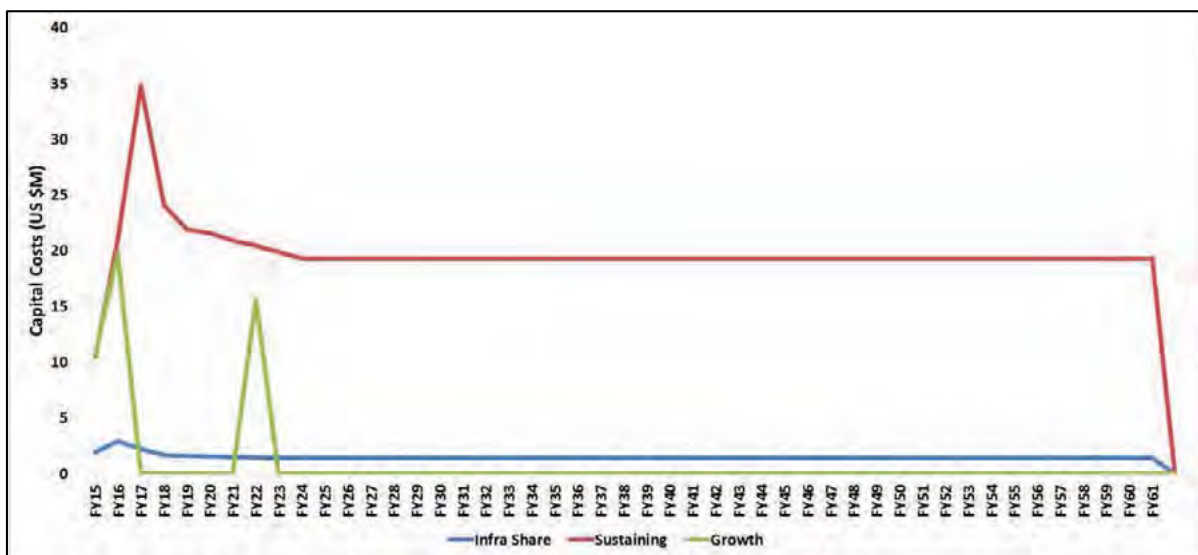

Figure 55 Wessels capital costs

5.5.4 Wessels Undiscounted Cash Flows – Base Case

The profile of undiscounted cash flows over the current Life of Asset is provided in Figure 56.



Figure 56 Wessels undiscounted cash flows – Base Case

5.5.5 Wessels NPV Valuation – Base Case

Using the key input assumptions described above as the Base Case, CSA Global has derived an ungeared, after-tax NPV of US\$454M for 100% of the Wessels Ore Reserves over the remaining mine life of 46.5 years from 31 Dec 2014 until 30 June 2061, the end of FY61 (Table 38).

Table 38 Base case value for Wessels Asset over the Life Of Mine to end of FY61

Item	Units	Amount
PHYSICALS		
Ore Reserve tonnes (wet)	Mt	69
Ore Reserve grade (recovered)	% Mn	42.2
Ore Reserve Yield	%	70
Total mine operating costs	US\$ M	5,116
Total unit operating costs	US\$ /mtu	1.90
Capital costs	US\$ M	950
Closure costs	US\$ M	35
Mine life	years	46.5
Discount rate	%	7.5
South Africa Country Risk Premium	%	3.0
NPV	US\$ M	454

5.5.6 Wessels NPV Valuation – Range Analysis

Keeping the quantitative physicals (tonnes, grades and costs) the same, the Base Case assumptions were varied to reflect the economic performance of the project under lower and higher commodity prices and exchange rates.

The long term benchmark Mn ore price was varied from the base case by $\pm 10\%$, as was the ZAR/US\$ exchange rate. When combined with discount factors derived from the after-tax real WACC of between 7.0% and 8.0%, and a South Africa country risk premium of 3%, a value range for 100% of the project was determined. The Base Case and Range NPVs are presented in Table 39, also showing the 44.4% share of Wessels that is owned by BHP Billiton.

Table 39 Range analysis of the Wessels Asset value over the Life Of Mine to end of FY61

Input Parameter	Units	Lower	Base	Upper
Long Term ore price 44% SL Mn Benchmark CIF China	US\$/dmu	4.81	5.34	5.88
Long Term Exchange Rate	ZAR/US\$	12.0	13.3	15.3
Real Discount Rate + County Risk	%	11.0	10.5	10.0
After-tax NPV	US\$ M	187	454	723
BHP Billiton share (44.4%)	US\$ M	83	202	321

5.5.7 Wessels Sensitivity Analysis

Tornado diagrams are used for deterministic sensitivity analysis to show the relative importance of input variables. Each of these are modelled separately while all other variables are held at the Base Case values. For the input parameters in Figure 57, optimistic and pessimistic values were selected to describe the reasonable sensitivity range over which these inputs might vary. It can be seen that the project is most sensitive to changes in the foreign exchange rate and revenue (due to the commodity price).

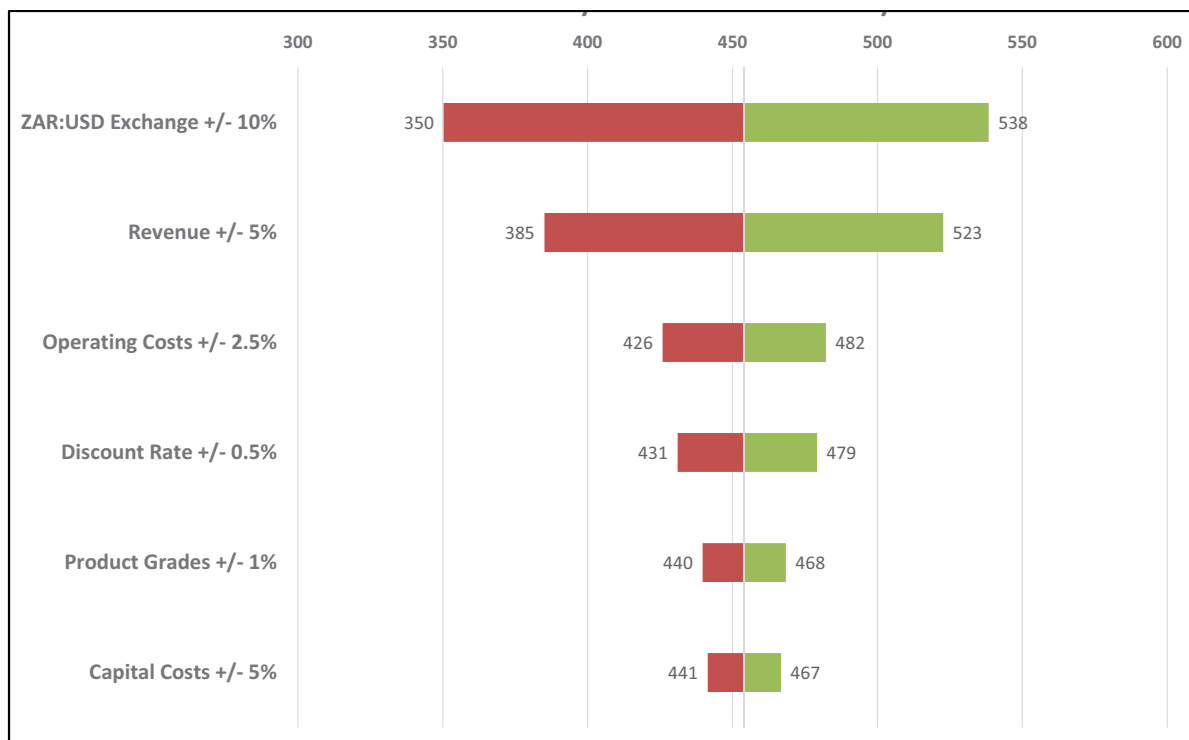

Figure 57 Wessels tornado diagram of sensitivities of Base Case to key drivers (US\$ M)

For Wessels the most impact on variance is due to the Exchange Rate. The exchange rate was used in the sensitivity analysis as Hotazel sales to the Metalloys smelter are under a ‘cost plus’ contract (until end of FY29), so independent of the Benchmark commodity price. A number of two variable sensitivity analyses were thus performed, whereby each of the other inputs was varied with the exchange rate, holding all other inputs at their Base Case values. These are presented in Figure 58 to Figure 62 in order of their impact as shown in the tornado diagram (Figure 57). Each of these shows the impacts on NPV over the variation range with the Base Case NPV in blue, the lowest in red and the highest in green.

		ZAR:USD Exchange VAR% to Base Case				
		90%	100%	110%	125%	
Revenue VAR% to Base Case	75%	454	206	315	400	502
	90%	41	280	385	469	573
	95%	124	350	454	538	643
	100%	204	420	523	608	714
	105%	279	489	592	679	783
	110%					

Figure 58 Wessels revenue and exchange rate variance to Base Case

		ZAR:USD Exchange VAR% to Base Case				
		90%	100%	110%	125%	
Operating Costs VAR% to Base Case	454	75%	475	567	641	735
	90%	272	475	567	641	735
	98%	161	381	482	564	666
	100%	124	350	454	538	643
	103%	87	319	426	513	621
	110%	-24	226	341	435	552

Figure 59 Wessels operating costs and exchange rate variance to Base Case

		ZAR:USD Exchange VAR% to Base Case				
		90%	100%	110%	125%	
Discount Rate VAR% to Base Case	454	75%	512	647	757	894
	8%	222	512	647	757	894
	10%	137	371	479	567	676
	11%	124	350	454	538	643
	11%	112	331	431	512	613
	13%	83	282	372	446	537

Figure 60 Wessels discount rate and exchange rate variance to Base Case

		ZAR:USD Exchange VAR% to Base Case				
		90%	100%	110%	125%	
Product Grades VAR% to Base Case	454	75%	314	418	502	607
	98%	81	314	418	502	607
	99%	107	336	440	524	629
	100%	124	350	454	538	643
	101%	141	365	468	553	658
	103%	167	387	490	575	680

Figure 61 Wessels product grade and exchange rate variance to Base Case

		ZAR:USD Exchange VAR% to Base Case				
		90%	100%	110%	125%	
Capital Costs VAR% to Base Case	454	379	479	562	664	
	90%	364	467	550	654	
	95%	350	454	538	643	
	100%	336	441	527	633	
	105%	322	429	515	622	
	110%	88				

Figure 62 Wessels capital costs and exchange rate variance to Base Case

5.5.8 Wessels Project Opportunities

The Wessels project is constrained to the mine leases and no material opportunities have been identified that are outside the current Ore Reserves and FY15 LoA plan.

5.5.9 Wessels Valuation Summary

CSA Global has determined a Valuation for the Wessels Asset of BHP Billiton based upon the stated Ore Reserves at 31 December 2014. A range of sensitivities relating to commodity price, the ZAR/US\$ exchange rate and discount rate were undertaken on the cash flow model. CSA Global considers the ranges selected are representative of a range of reasonable outcomes for these key assumptions over the life of the Asset. The Base Case Value determined by CSA Global for BHP Billiton's 44.4% share of the Wessels Asset is US\$202 million. The Wessels Mine has an expected mine life of 46.5 years to the end of FY61.

CSA Global does not consider that opportunities exist which will realise additional value above that presented as the Base Case Valuation of the Ore Reserve. In terms of the VALMIN Code, the Base Case NPV is a Technical Value derived from a static cash flow model, rather than a Market Value. In CSA Global's opinion the Technical Value fairly represents the Market Value for the Wessels Asset.

The Market or Fair Value for 100% of the Wessels Asset based on the Ore Reserves is therefore expected to lie in the range from US\$187M to US\$723M, with a most likely value of US\$454M. BHP Billiton's 44.4% share, rounded to an appropriate level of precision, is valued in the range from US\$80M to US\$320M with a most likely value of US\$200M.

This valuation is reflective of Hotazel's mining operations at the Wessels Mine, based on CSA Global's view in relation to manganese Ore Reserves only. It is important to emphasise that this value does not represent the value of the Ore Reserves in the ground in isolation, but incorporates the value of all ungeared net assets contributing to the project based on the Ore Reserve production profile. At Wessels Mine this includes the value of the underground development, mining equipment fleet, beneficiation plant, rail load out and all other supporting infrastructure as well as the mine, over the projected Life of Asset.

6 References

- Beukes, N. J., 1983. Palaeoenvironmental setting of iron formations in the depositional basin of the Transvaal Supergroup, South Africa. In: Trendall, A. F., Morris, R. C. (Eds.), *Iron-Formation: Facts and Problems*. Elsevier, Amsterdam, pp. 131-209.
- BHP Billiton, 2013. SA Manganese Asset FY15 LoA. Unpublished BHP Billiton report, September.
- BHP Billiton, 2014. BHP Billiton Annual Report available on www.bhpbilliton.com.
- CRU, 2014. Mn Ore Market Outlook, October, CRU International.
- Ferreira, E. P., Nengovhela, A. C. and Mathebula, D. S., 2014a. Competent Person Report for Hotazel Manganese Mines, Mamatwan Mine, including Mineral Resources and Ore Reserves as at 30 June 2014. Unpublished BHP Billiton report, June (CP FY14).
- Ferreira, E. P., Nengovhela, A. C. and Mathebula, D. S., 2014b. Competent Person Report for Hotazel Manganese Mines, Wessels Mine, including Mineral Resources and Ore Reserves as at 30 June 2014. Unpublished BHP Billiton report, June (CP FY14).
- JORC Code, 2012. Australasian Code for Reporting of Exploration Results, Mineral Resources and Ore Reserves. Prepared by the Joint Ore Reserves Committee of the Australasian Institute of Mining and Metallurgy, Australian Institute of Geoscientists and Minerals Council of Australia (JORC).
- VALMIN Code, 2005. Code for the Technical Assessment and Valuation of Mineral and Petroleum Assets and Securities for Independent Expert Reports. VALMIN Committee, a joint committee of AusIMM, AIG and MICA.

This page has been intentionally left blank.

ANNEXURE 6

INDEPENDENT COMPETENT PERSONS' REPORTS

6. Cerro Matoso – SRK Consulting

This page has been intentionally left blank.

A Competent Person's Report and Valuation Report on Cerro Matoso, Colombia

Report Prepared for

BHP Billiton and South32 Limited

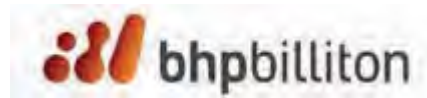

Report Prepared by



SRK Consulting (Australasia) Pty Ltd

BHP151

March 2015

A Competent Person's Report and Valuation Report on Cerro Matoso, Colombia

BHP Billiton

Level 12, 171 Collins Street, Melbourne VIC 3000 Australia
and

South32 Limited

Level 20, Waterfront Place
1 Eagle Street, Brisbane Qld 4000 Australia

SRK Consulting (Australasia) Pty Ltd

Level 1, 10 Richardson Street, West Perth WA 6005 Australia

e-mail: perth@srk.com.au
website: srk.com.au
Tel: +61 8 9288 2000
Fax: +61 8 9288 2001

SRK Project Number BHP151

March 2015

Compiled by

Simon Hanrahan
Principal Consultant

Email: shanrahan@srk.com.au

Peer Reviewed by

Peter Fairfield
Principal Consultant

Authors:

Ian De Bruyn; Luke Esprey; Danny Kentwell; Dave Luppnow; Carl Murray;
Trivindren Naidoo; John Reid; Anthony Stepcich; David Western; Maria Ines Vidal.

Executive Summary

Background

SRK Consulting (Australasia) Pty Ltd (SRK) has been commissioned by South32 Limited (**South32**) and BHP Billiton, which includes South32 Limited, BHP Billiton Limited and BHP Billiton Plc (herein after also referred to as the **Company**) to prepare a Competent Person's Report, including a Valuation (**CPR**) on Cerro Matoso SA (**CMSA**). BHP Billiton Limited and BHP Billiton Plc are public companies (ticker; **BHP and BLT**) listed on the London Stock Exchange (**LSE**), the Australian Stock Exchange (**ASX**), the New York Stock Exchange (**NYSE**) and the Johannesburg Stock Exchange (**JSE**) and have a 99.98% holding in the CMSA operation. The CMSA operation is situated in Cordoba, Colombia.

BHP Billiton (is considering the demerger of certain aluminium, coal, manganese, nickel and silver assets (Demerger); CMSA is part of this consideration.

The demerged assets will be held by South32. It is currently intended that South32 will be listed on the ASX and JSE, and potentially on the Official List of the United Kingdom Listing Authority (**UKLA**) (together, the Relevant Listing Authorities).

This CPR presents the following key technical information as at the Effective Date (31 December 2014):

- Mineral Resource and Ore Reserve statements (the **2014 Statements (CMSA)**) reported in accordance with the terms and definitions of the JORC Code (defined below)
- Ore Reserve statements (the **2014 Statements (SRK Depleted)**) reported in accordance with the terms and definitions of the JORC Code (defined below) and used as the basis for the Valuation
- The associated Life-of-Mine plans (**LOMPs**) and associated technical and economic parameters (**TEPs**) included in the LOMPs
- A Technical Valuation for the CMSA as at 31 December 2014.

Requirement and Reporting Standard

The reporting standard adopted for the reporting of the 2014 Statements (**SRK Depleted**) for CMSA is that defined by the terms and definitions given in "*The 2012 Australasian Code for Reporting of Exploration Results, Mineral Resources and Ore Reserves (the JORC Code) as published by the Joint Ore Reserves Committee of The Australasian Institute of Mining and Metallurgy, Australian Institute of Geoscientists and Minerals Council of Australia*". The JORC Code is an internationally recognised reporting code as defined by the Combined Reserves International Reporting Standards Committee. SRK has been informed that the JORC Code is currently adopted by the Company in respect of Mineral Resource and Ore Reserve reporting.

The reporting standard adopted for the reporting of the Valuation for CMSA is the "**Code for the Technical Assessment and Valuation of Mineral and Petroleum Assets and Securities for Independent Expert Reports: The VALMIN Code (2005 Edition)**", (the **VALMIN Code 2005**).

Reliance on SRK

The CPR is addressed to and may be relied upon by the Company, the Directors of the Company, the Shareholders of the Company and the Advisors of the Company in support of the Demerger, specifically in respect of compliance with the Requirements. SRK is responsible for this CPR and for all of the technical information in the prospectus released by the Company in connection with the Demerger and dated the same date as the CPR (the South32 Listing Documents) that has been extracted directly from this CPR. SRK declares that it has taken all reasonable care to ensure that this CPR and the technical information extracted here from and included in the South32 Listing Documents is, to the best of its knowledge, in accordance with the facts and contains no omission likely to affect its import.

SRK has no obligation or undertaking to advise any person of any development in relation to CMSA which comes to its attention after the date of this CPR or to review, revise or update the CPR or opinion in respect of any such development occurring after the date of this CPR.

The Competent Person who has reviewed the Mineral Resources as reported by BHP Billiton is Mr Danny Kentwell, MSc (Mathematics & Planning), BAppSc (Surveying), who is an employee of SRK. He is a Fellow of The Australasian Institute of Mining and Metallurgy within the meaning of the JORC Code. Danny Kentwell is a geostatistician with over 25 years' experience in the mining industry and has been involved in the reporting of Mineral Resources on various properties internationally during the past 12 years.

The Competent Person who has reviewed the Ore Reserves as reported by BHP Billiton is Mr Carl Murray, BEng (Mining), who is an employee of SRK. He is a Member of The Australasian Institute of Mining and Metallurgy. Mr Carl Murray is a mining engineer with over 25 years' experience in the mining industry and has been involved in the reporting of Ore Reserves on various properties during the past 15 years.

The Competent Person and Competent Evaluator is Mr Anthony Stepcich, MSc (Mineral Economics), BEng (Mining), Grad Dip (Finance & Investment), Dip (Technical Analysis), MAusIMM(CP), who is an employee of SRK. Anthony Stepcich is a mining engineer with over 20 years' experience in the mining and metals industry and has been involved in the preparation of Competent Persons' Report comprising technical valuations on various mineral assets internationally during the past 9 years. Anthony Stepcich assumes the responsibility for the estimates presented and has the relevant experience to be considered an Expert under the VALMIN guidelines.

Whilst SRK has exercised all due care in reviewing the supplied information, SRK does not accept responsibility for finding any errors or omissions contained therein and disclaims liability for any consequences of such errors or omissions.

SRK's assessment of CMSA's Mineral Resources and Ore Reserves, TEP forecasts and the Valuation for CMSA is based on information provided by the Company and CMSA throughout the course of SRK's investigations, which in turn reflect various technical economic conditions prevailing at the date of this report. In particular, the Ore Reserves, the TEPs and the Valuation for CMSA are based on expectations regarding the commodity prices and exchange rates prevailing at the Effective Date of this CPR. These TEPs can change significantly over relatively short periods of time. Should these change materially, the TEPs could be materially different in these changed circumstances. This CPR specifically excludes all aspects of legal issues, marketing, commercial and financing matters, insurance, land titles and usage agreements, and any other agreements and/or contracts that CMSA may have entered into.

This CPR includes technical information, which requires subsequent calculations to derive subtotals, totals and weighted averages. Such calculations may involve a degree of rounding and consequently introduce an error. Where such errors occur, SRK does not consider them to be material.

Review process

SRK has conducted a review (which specifically excludes independent verification by means of re-calculation) and assessment of all material technical issues likely to influence the future performance of CMSA and the resulting TEPs which included the following:

- Inspection visits to the CMSA's mining and processing facilities and associated infrastructure undertaken during November 2014
- Enquiry of key mine and head office personnel during Q4 2014 in respect of the CMSA operation, the 2014 Statements (SRK Depleted), the TEPs and other related matters
- Examination of historical information for the financial reporting periods ended 30 June 2014
- Review of the 2014 Statements (CMSA) for CMSA – whilst SRK has not re-estimated the Mineral Resources and Ore Reserves, SRK has performed all necessary validation and verification procedures deemed appropriate in order to place reliance on such information
- Reporting of the 2014 Statements (SRK Depleted) based on Ore Reserve depletion adjustments to the 2014 Statements (CMSA)
- Examination, review and where appropriate modification of technical studies and LOMPs completed in respect of CMSA and all conclusions and recommendations drawn therefrom
- Valuation of the CMSA operations.

SRK has also assessed the reasonableness of the macro-economic and commodity price assumptions as currently assumed in the projections for inclusion in the 2014 Statements (SRK Depleted), the TEPs and the Valuation for CMSA operations.

Overview of the CMSA operations

Introduction

CMSA is an open pit lateritic nickel mine that is located 25 km south west of the town of Montelibano, in Cordoba Province, northern Colombia. The operation consists of an open pit and associated smelter and refinery that produces ferronickel granules that are exported through the Caribbean port of Cartagena 260 km to the north. Annual production is approximately 3 Mtpa of ore feed to the processing plant that produces some 130,000t of FeNi product.

Title and Rights

CMSA has exploration and exploitation rights in an area of 52,850 hectares denominated 051-96M contract.

In December 2012, an amendment to the contract was agreed, known as the Otrósí N° 4. Pursuant to the Amendment, the concession period is extended for an additional fifteen (15) years up to 1 August 2044 subject to CMSA increasing, directly or indirectly, the dry ore processing capability from 3.0 million tons per year up to 4.5 million tons per year, within a period of ten (10) years since the formalization of the agreement (December 2012), otherwise it will expire in 2029 with the possibility of applying for an extension.

Geology

The CMSA deposit is located to the south of Cordoba and north of Antioquia regions, where three peridotite bodies are present in a north-south orientation, referred to as the Cerro Matoso nickel belt. The peridotites are associated with a Cretaceous ophiolite complex, located along the northern extension of the regional NNE–SSW-oriented Cauca-Romeral fault system. Tertiary age argillaceous sediments with local coal horizons surround the peridotites.

The local geological setting of Cerro Matoso is characterised by a complex set of rock types that have been grouped into a number of major rock sets.

This geological basis for the rock type grouping is critical, as the local laterite profile is characterised not only by the evolutionary products of a typical tropical laterite weathering profile, but by several unique lithologies that also occur, including tachylite and very dark (black) saprolite units.

Mineral Reserves and Ore Reserves

As at 31 December 2014; CMSA had Ore Reserves of 47Mt grading 1.19% Ni. Mineral Resources are reported inclusive of Ore Reserves and total 335 Mt grading 0.9% Ni.

Mining Operation

The Cerro Matoso laterite orebody is located on the east side of the Uré River and presents as a cap layer on a 200 m-high hill making open cut mining operations relatively straight forward. CMSA feeds approximately 3 Mtpa of ore to the primary crusher direct from the pit face or stockpile, with lower grade materials and waste stored to the south of the mining operation.

The CMSA nickel operation is a well-established open cut mining operation carried out predominantly as an owner-operator. The Main Pit is broken into a number of pits and uses a traditional truck-and-shovel mining approach. The operation is a mix of selective and bulk mining areas in both ore and waste. The pit design is relatively shallow, (approximately 70 m depth), however, the original hill height was approximately 200 m above the surrounding surface level.

Processing

The CMSA processing consists of a crushed ore being fed into an ore drying and calcination process ahead of electric furnaces and finally ferronickel (FeNi) refining to produce FeNi granules for export. A challenge facing the operation in the future is the increasing silica content of the ore (SiO_2 : MgO ratio) and investigations are currently taking place to optimise the electric furnace operation. In addition, an ore upgrading project is underway with the aim of removing silica ahead of plant feed.

Tailings Storage Facility

There are no tailings from the pyrometallurgical process, but it does produce a slag product, which is stacked.

In 2007, a Metal Nickel Recovery (MNR) plant was commissioned and the resulting tailings from this plant is stored in the La Sajana slag tailings disposal facility.

Environmental liabilities

CMSA has made a provision of US\$161M for closure as of 2015.

Concluding remarks

Mineral Resources and Ore Reserves

The 2014 Statements (SRK Depleted) for CMSA are summarised in Table ES-1 and Table ES-2.

SRK concludes that the Mineral Resources and Ore Reserves as stated herein are reported in accordance with the terms and definitions of the JORC Code (2012). Mineral Resources are reported inclusive of Ore Reserves.

Table ES-1: Mineral Resource as at 31 December 2014 (inclusive of Reserves)

Classification	Type	Ore (Mdt)	Ni (%)	Fe (%)	MgO (%)	SiO ₂ (%)	Al ₂ O ₃ (%)
Measured Resource	Laterite	42	1.2	11.8	21.5	42.8	2.3
	Stockpiles	49	1.1	17	19.8	37.4	2.1
Indicated Resource	Laterite	178	0.9	18.9	9.4	36.3	4.4
Inferred Resource	Laterite	66	0.8	18.8	9.1	37.2	4.9
Total		335	0.9	17.7	12.5	37.5	3.9
MNR Ore – Measured Resource ⁽¹⁾		17	0.2	-	-	-	-

Table ES-2: Ore Reserves as at 31 December 2014

	Ore (Mdt)	Ni%	Source
Reserve as at 30 June 2014	48.5	1.2	CMSA CP Report 2014
Depletion July 2014 to Oct 2014 (actuals)	0.95	1.62	Monthly reports
Forecast Nov 2014	0.26	1.64	5YP_Plan quiquenal FY15toFY19RTV4.0_20140327
Forecast Dec 2014	0.27	1.64	5YP_Plan quiquenal FY15toFY19RTV4.0_20140327
Calculated Reserve Estimate as at 31 December 2014	47.0	1.19	

Valuation

The preferred Technical Value based on CMSA's Ore Reserves is US\$593M (98.98% holding).

This value is derived from the net present value of the after tax cash flows as determined in the financial model, assuming consensus market forecasts and a long term Nickel price of US\$7.90/lb.

Table of Contents

Executive Summary	iii
1 Introduction	1
1.1 Background	1
1.2 Reporting compliance, reporting standard and reliance	2
1.2.1 Reporting Compliance	2
1.2.2 Reporting Standard	2
1.2.3 Reliance on SRK	2
1.3 Base technical information date, effective date and publication date	2
1.4 Verification and validation	3
1.5 Limitations, reliance on information, declaration, consent and cautionary statements	4
1.5.1 Limitations	4
1.5.2 Reliance on information	4
1.5.3 Declaration	5
1.5.4 Consent	5
1.6 Qualifications of Consultants, Competent Persons and Competent Evaluators	6
2 Overview	8
2.1 Property description	8
2.2 Property rights	8
2.3 Permits and approvals	10
3 Geology	11
3.1 Geological setting	11
3.2 Deposit Geology and structure	12
3.2.1 Sedimentary cover	13
3.2.2 Limonitic zone	13
3.2.3 Saprolitic zone	14
3.2.4 Fresh rock	14
3.2.5 Structure	14
3.2.6 Transported material	15
3.2.7 Mineralisation	15
3.3 Summary comments	15
4 Mineral Resource and Ore Reserve	17
4.1 Mineral Resource Estimation and Classification	17
4.1.1 Data acquisition	17
4.1.2 Geological modelling	18
4.1.3 Resource estimation	18
4.1.4 Resource classification	20
4.1.5 Reasonable prospects of eventual economic extraction	22
4.1.6 Model validation	22

4.1.7	Stockpile Resource definition	22
4.1.8	Mineral Resource Statement – 30 June 2014	23
4.1.9	Mineral Resource Statement (SRK Depleted)	23
4.1.10	Independent audits and reviews	24
4.1.11	Historical Mineral Resource Statements	24
4.1.12	Summary comments	25
4.2	Ore Reserve estimation and classification	28
4.2.1	Stage 1 – Modifying factors	28
4.2.2	Stage 2 – Pit optimisation	30
4.2.3	Stage 3 – Design and scheduling	30
4.2.4	Ore Reserve statement	31
4.2.5	Historical Ore Reserve Statements	32
4.2.6	Historical reconciliation	33
4.2.7	Ore Reserve (SRK Depleted) - 31 December 2014	35
4.2.8	Summary comments	36
5	Geotechnical Engineering	38
5.1	Introduction	38
5.2	Geological conditions	38
5.3	Groundwater	38
5.4	Rockmass conditions	38
5.5	Slope stability	39
5.6	Summary comments	40
6	Hydrology and Hydrogeology	41
6.1	Hydrology	41
6.1.1	Physical setting	41
6.1.2	Water supply and water balance	41
6.1.3	Flood management	41
6.1.4	Data monitoring systems related to surface water management	42
6.1.5	Summary comments	42
6.2	Hydrogeology	43
6.2.1	Hydrogeological environment	43
6.2.2	Dewatering status	43
6.2.3	Water management	43
6.2.4	Summary comments	43
7	Mining Engineering	44
7.1	Introduction	44
7.2	Mine design and mining method	45
7.2.1	Mining method	45
7.2.2	Mine design	47
7.2.3	Mine infrastructure	47

7.2.4	Waste dump design.....	47
7.2.5	Ore stockpiles.....	48
7.2.6	Mining equipment.....	48
7.2.7	Maintenance.....	48
7.3	Mine schedule.....	49
7.4	Historical operating performance.....	51
7.5	Planned operating expenditure.....	51
7.6	Capital expenditure.....	52
7.7	Operational improvement.....	52
7.8	Risk and opportunity.....	53
7.9	Summary comments.....	53
8	Mineral Processing.....	55
8.1	Processing History.....	55
8.2	Plant operations.....	57
8.2.1	Stockpiles and crusher feed.....	57
8.2.2	Drying.....	58
8.2.3	Ore upgrading.....	58
8.2.4	Calcination.....	59
8.2.5	Smelting.....	59
8.2.6	Ferronickel refining, shotting and packaging.....	60
8.2.7	Slag reprocessing.....	60
8.3	Heap leaching project.....	61
8.4	Process optimisation studies.....	61
8.4.1	Stockpile Chemistry Optimisation Project (SCOP).....	61
8.4.2	Ore Upgrading 2.....	62
8.4.3	Optimised Base Plan.....	64
8.5	Costs.....	64
8.5.1	Operating cost.....	64
8.5.2	Energy costs – Electricity, Gas, Coal.....	65
8.5.3	Sustaining Capital.....	65
8.6	Risk and opportunities.....	65
8.7	Summary comments.....	66
9	Infrastructure.....	67
9.1	Access.....	67
9.2	Power.....	68
9.3	Water.....	68
9.4	Communications.....	68
9.5	Support infrastructure buildings.....	68
10	Tailings Storage Facilities.....	69
10.1	Introduction.....	69

10.2	TSF design.....	69
10.3	TSF construction and operation.....	71
10.4	Closure.....	71
10.5	Risks and opportunities.....	71
10.6	Summary comments.....	71
11	Human Resources.....	73
11.1	Forward looking strategy.....	73
11.2	Industrial relations.....	73
11.3	Recruitment.....	73
11.4	Summary comments.....	73
12	Occupational Health and Safety.....	74
12.1	OHS performance.....	74
12.2	Summary comments.....	75
13	Environmental.....	76
13.1	Introduction.....	76
13.2	Environmental setting.....	76
13.2.1	Land use.....	76
13.2.2	Socio-economics.....	76
13.2.3	Climate.....	77
13.2.4	Surface Water.....	77
13.2.5	Hydrogeology.....	77
13.2.6	Biodiversity.....	77
13.3	Environmental Permitting and Compliance.....	77
13.3.1	Required Permits and Status.....	77
13.4	Environmental and Social Management and Monitoring.....	80
13.4.1	Water Management.....	81
13.4.2	Air quality.....	81
13.4.3	Biodiversity.....	82
13.4.4	Socio-economic.....	82
13.5	Closure Plan and Costs.....	83
13.6	Summary comments.....	85
13.6.1	Environmental and Social.....	85
13.6.2	Closure.....	85
14	Valuation – Methodology.....	87
14.1	Introduction.....	87
14.2	Reporting standard.....	87
14.3	Valuation Method.....	87
14.4	Materiality.....	88
14.5	Summary comments.....	88
15	Valuation – Value.....	89

15.1	Commodity prices & Macro-economics	89
15.1.1	Introduction.....	89
15.1.2	Commodity price	89
15.1.3	Macro-economics	90
15.2	Financial model structure and Inputs.....	92
15.2.1	Introduction.....	92
15.2.2	Model assumptions	92
15.3	Financial model results	93
15.4	Benchmarking	97
15.4.1	Introduction.....	97
15.4.2	Definitions.....	97
15.4.3	2015 Cash cost comparison.....	98
15.5	Discounted cash flow result	99
15.6	Sensitivity analysis	99
15.7	Comparable transaction analysis.....	100
15.7.1	Nickel and Cobalt price history 2005 to 2014	100
15.7.2	Comparative transactions.....	101
15.7.3	Analysis of transactions.....	107
15.7.4	Comparison with Yardstick method.....	109
15.7.5	Market-based valuation	109
15.8	Risk and Opportunities.....	110
15.9	Summary comments	111
16	Concluding Remarks.....	112
16.1	Introduction	112
16.2	Mineral Resources and Ore Reserves.....	112
16.3	Valuation	112
16.4	Principal issues	113
	List of Abbreviations.....	115

List of Tables

Table 3-1:	Rock types and rock sets.....	12
Table 4-1:	30 June 2014 Mineral Resource (based on drilling information to 30 December 2011)	23
Table 4-2:	31 December 2014 Mineral Resource (based on drilling information to 30 December 2011)	23
Table 4-3:	Remaining Resources at 30 June 2013 inside Maximum Pit Shell (COG 0.6% Ni), including stockpiles and Slag Stockpile, based on E-Model 2011.....	25
Table 4-4:	Remaining Resources at 30 June 2012 inside Maximum Pit Shell (COG 0.6% Ni), including stockpiles and Slag Stockpile, based on E-Model 2010.....	25
Table 4-5:	Remaining Resources at 30 June 2011 inside Maximum Pit Shell (COG 0.6% Ni), including stockpiles and Slag Stockpile, based on E-Model 2009.....	25
Table 4-6:	Ore Reserve Estimate, 30 June 2014.....	31

Table 4-7:	Statement of Ore Reserve Estimate, E-Model 2011, June 2013, (0.8% Ni cut-off).....	32
Table 4-8:	Statement of Ore Reserve Estimate, E-Model 2010, June 2012, (0.8% Ni cut-off).....	32
Table 4-9:	Statement of Ore Reserve Estimate, E-Model 2009, June 2011, (0.8% Ni cut-off)	33
Table 4-10:	Ore Reserve (SRK Depleted) - 31 December 2014	36
Table 6-1:	Uré River water surface levels and freeboard parameters for selected return periods	42
Table 7-1:	Historical tonnes and grade mined	51
Table 7-2:	Mining equipment sustaining capital from the FY15-FY19 5 year plan	52
Table 8-1:	Current dryer feed ore composition	58
Table 8-2:	Upgrading parameters	59
Table 8-3:	Plant operating costs, YTD October 2014	65
Table 8-4:	Cost breakdown of electricity, gas and coal	65
Table 8-5:	Sustaining capital, 2015 to 2019 - without and with major project CAPEX	65
Table 13-1:	Population of CMSA's area of social influence	76
Table 13-2:	Environmental Licenses of CMSA	78
Table 13-3:	Closure cost estimation by facility.....	84
Table 15-1:	Consensus market forecasts	89
Table 15-2:	Discount rate calculation	92
Table 15-3:	Valuation summary	93
Table 15-4:	Valuation summary	99
Table 15-5:	Sensitivity analysis	99
Table 15-6:	Summary of relevant transactions involving nickel laterite projects between January 2005 and October 2014	103
Table 15-7:	Transactions analysed in terms of reserves	106
Table 15-8:	Analysis of transactions in terms of Reserves	107
Table 15-9:	Summary of market-based valuation ranges (100% basis).....	110
Table 15-10:	Summary of market-based valuation ranges (99.98% basis).....	110
Table 16-1:	Mineral Resource as at 31 December 2014 (inclusive of Reserves).....	112
Table 16-2:	Ore Reserves as at 31 December 2014	112

List of Figures

Figure 2-1:	Area of Mining Concession Contract 051.96M	9
Figure 3-1:	Regional geological setting	11
Figure 3-2:	Typical rock set profile	13
Figure 3-3:	Bench mapping of rock type and structures	16
Figure 3-4:	Section showing structurally related depth extensions	16
Figure 4-1:	Resource classification plan views by rock set 1, 2, 4, 5 and 6.....	21
Figure 4-2:	Post-December 2011 drilling (in red)	26
Figure 4-3:	Example cross sections of deep structures carrying grade	27
Figure 4-4:	Resource to Recoverable Reserve model process	29
Figure 4-5:	F1 reconciliation factors May 2011 to June 2014	34
Figure 4-6:	F1 reconciliation factors May 2011 to June 2014	35
Figure 4-7:	F3 reconciliation factors May 2011 to June 2014	35
Figure 6-1:	Overview of Main Pit and Uré River	41
Figure 7-1:	Pit numbering of Cerro Matoso pit	44
Figure 7-2:	Layout of pits and infrastructure.....	45
Figure 7-3:	Mining location example (compliance to plan) - September 2014.....	46
Figure 7-4:	Graphical presentation of LOM production schedule physicals by year	50
Figure 7-5:	Mining as a percentage of total operating expenditure	51
Figure 7-6:	LOM mining operation costs	52
Figure 8-1:	% Ni to Crusher 1982 - 2014	55
Figure 8-2:	Progressive Ni cut-off grade	56
Figure 8-3:	Projected crusher feed grades.....	56
Figure 8-4:	Processing flowsheet	57
Figure 8-5:	Ferronickel product – packaging either in 2 t bags or bulk containers	60
Figure 8-6:	Upgrade plant comparison	62
Figure 8-7:	Simplified flowsheet of pilot plant under construction for testing in December.....	63
Figure 8-8:	Flowsheet of proposed Upgrade 2 plant.....	63
Figure 9-1:	Location map showing site and port	67
Figure 9-2:	Existing bridge over the St George River.....	68
Figure 10-1:	Layout of initial as-built facility	70
Figure 10-2:	Typical dam section for tailings and water management dam.....	70
Figure 12-1:	Historical incident rate.....	74
Figure 12-2:	Occupational illness events	74
Figure 12-3:	Significant incidents	75
Figure 13-1:	Area of Environmental Licenses	79
Figure 15-1:	Consensus nickel price forecast	90
Figure 15-2:	Historical nickel price	91
Figure 15-3:	Mine production profile.....	94
Figure 15-4:	Ferronickel production profile.....	94

Figure 15-5: Operating costs	95
Figure 15-6: Capital costs.....	95
Figure 15-7: Taxes & royalties.....	96
Figure 15-8: Revenue	96
Figure 15-9: After tax cash flow.....	97
Figure 15-10: LOM cash cost profile	98
Figure 15-11: C1 nickel cash costs	98
Figure 15-12: Sensitivity analysis	100
Figure 15-13: NPV versus discount rate.....	100
Figure 15-14: Nickel and cobalt price history, 2005 to 2014	101
Figure 15-15: Transactions involving Ni laterite projects with declared reserves	108
Figure 15-16: Transactions involving Ni laterite properties with declared reserves.....	108
Figure 15-17: Grade and contained metal versus normalised transaction prices in US\$/t.....	109

List of Appendices

Appendix A: Key terms - Otrosí N° 4

1 Introduction

1.1 Background

SRK Consulting (Australasia) Pty Ltd (SRK) has been commissioned by South32 Limited (**South32**) and BHP Billiton (**BHP Billiton**), which includes BHP Billiton Limited and BHP Billiton Plc (herein after also referred to as the **Company**) to prepare a Competent Person's Report, including a Valuation (**CPR**) on Cerro Matoso S.A. (**CMSA**). BHP Billiton Limited and BHP Billiton Plc are public companies (ticker; **BHP and BLT**) listed on the London Stock Exchange (**LSE**), the Australian Stock Exchange (**ASX**), the New York Stock Exchange (**NYSE**) and the Johannesburg Stock Exchange (**JSE**) and have a 99.98% holding in the CMSA operation. The CMSA operation is situated in Cordoba, Colombia.

BHP Billiton is considering the demerger of certain aluminium, coal, manganese, nickel and silver assets (Demerger) of which CMSA is part of this consideration.

The demerged assets will be held by South32. It is currently intended that South32 will be listed on the **ASX** and the Johannesburg Stock Exchange (**JSE**), and potentially on the Official List of the United Kingdom Listing Authority (**UKLA**) (together, the Relevant Listing Authorities).

CMSA is an open pit lateritic nickel mine in Cordoba, Colombia. The operation consists of an open pit mine, smelter and refinery that produces ferronickel granules.

CMSA has exploration and exploitation rights in an area of 52,850 hectares denominated 051-96M contract. In December 2012, an amendment to the contract was agreed, known as the Otrosi N° 4. Pursuant to the Amendment, the concession period is extended for an additional 15 years up to 1 August 2044 subject to CMSA increasing, directly or indirectly, the dry ore processing capability from 3.0 Mtpa up to 4.5 Mtpa, within a 10-year period of formalisation of the agreement (December 2012), otherwise it will expire in 2029 with the possibility of applying for an extension.

The Company has informed SRK that the mineral assets (the **Mineral Assets**) which comprise the focus of the CPR are limited to the established Cerro Matoso mine and the current Mineral Resources and Ore Reserves. The Company has advised SRK that it is not appropriate to report on any other Mineral Assets, i.e. exploration.

As at 31 December 2014, based on depletion adjustments alone, SRK reports the following in respect of CMSA (on a 100% basis):

- Ore Reserves of approximately 47 million tonnes (Mt) grading 1.19% Ni
- Measured, Indicated and Inferred Mineral Resources of approximately 335Mt grading 0.9% Ni.

This CPR presents the following key technical information as at the Effective Date (defined below):

- Mineral Resource and Ore Reserve statements (the **2014 Statements (SRK Depleted)**) reported in accordance with the terms and definitions of the JORC Code (defined below)
- Associated Life of Mine plans (**LOMPs**) and associated technical and economic parameters (**TEPs**) included in the LOMPs
- Valuation for the Cerro Matoso mine as at 31 December 2014.

Certain units of measurements and technical terms defined in the JORC Code are defined in the list of abbreviations included at the end of this CPR.

Unless otherwise stated, all statistics presented are on a 100% basis.

1.2 Reporting compliance, reporting standard and reliance

1.2.1 Reporting Compliance

SRK has been informed that the Company is required to comply with the following requirements which together comprise the **Requirements**: European Securities and Markets Authority (**ESMA**); ESMA/2013/319.

1.2.2 Reporting Standard

The reporting standard adopted for the reporting of the 2014 Statements (**SRK Depleted**) for CMSA is that defined by the terms and definitions given in *“The 2012 Australasian Code for Reporting of Exploration Results, Mineral Resources and Ore Reserves (the JORC Code) as published by the Joint Ore Reserves Committee of The Australasian Institute of Mining and Metallurgy, Australian Institute of Geoscientists and Minerals Council of Australia”*. The JORC Code is an internationally recognised reporting code as defined by the Combined Reserves International Reporting Standards Committee. SRK has been informed that the JORC Code is currently adopted by the Company in respect of Mineral Resource and Ore Reserve reporting.

The reporting standard adopted for the reporting of the Valuation for CMSA is the **“Code for the Technical Assessment and Valuation of Mineral and Petroleum Assets and Securities for Independent Expert Reports: The VALMIN Code (2005 Edition)”**, (the **VALMIN Code 2005**).

1.2.3 Reliance on SRK

This CPR is addressed to and may be relied upon by the Company, the Directors of the Company, the Shareholders of the Company, and the Advisors of the Company in support of the Demerger, specifically in respect of compliance with the Requirements. Accordingly, SRK agrees that the CPR may be made available to and relied upon by the Company’s various financial, legal and accounting advisors (the Advisors). SRK is responsible for this CPR and for all of the technical information in the prospectus released by the Company in connection with the Demerger and dated the same date as the CPR (the South32 Listing Documents) that has been extracted directly from this CPR. SRK declares that it has taken all reasonable care to ensure that this CPR and the technical information extracted here from and included in the South32 Listing Documents is, to the best of its knowledge, in accordance with the facts and contains no omission likely to affect its import.

SRK believes that its opinion must be considered as a whole and that selecting portions of the analysis or factors considered by it, without considering all factors and analyses together, could create a misleading view of the process underlying the opinions presented in this CPR. The preparation of a CPR is a complex process and does not lend itself to partial analysis or summary.

SRK has no obligation or undertaking to advise any person of any development in relation to CMSA which comes to its attention after the date of this CPR or to review, revise or update the CPR or opinion in respect of any such development occurring after the date of this CPR.

1.3 Base technical information date, effective date and publication date

The effective date of the CPR is 31 December 2014 (the **Effective Date**). The 2014 Statements (SRK Depleted) and the Valuation, have been prepared as at the Effective Date in reliance on:

- 2014 Statements (CMSA) as declared and published by BHP Billiton in their annual report for the year ending 30 June 2014 (the **Base Technical Information Date**)

- Adjustments made to the 2014 Mineral Resource and Ore Reserve Statements (CMSA) by SRK having conducted, inter alia, depletion and historical performance analyses and a review of any additional information dated after the Base Technical Information Date published by the Company.

As advised by the Company, as at the publication date of this CPR (the **Publication Date**), no material change has occurred since the Effective Date. This includes, inter alia, no material change to the 2014 Statements (SRK Depleted) or to the Valuation for the Cerro Matoso mine.

1.4 Verification and validation

SRK has conducted a review (which specifically excludes independent verification by means of re-calculation) and assessment of all material technical issues likely to influence the future performance of the CMSA and the resulting TEPs which included the following:

- Inspection visits to the CMSA mine and processing facilities and associated infrastructure undertaken by Danny Kentwell, Carl Murray, John Reid and Maria Ines Vidal for a total of three days during the week commencing 3 November 2014
- Enquiry of key mine and head office personnel during Q4 2014 in respect of the CMSA assets, the 2014 Statements (SRK Depleted), the TEPs and other related matters
- Examination of historical information for the financial reporting periods ended 30 June 2014
- Review of the 2014 Statements (BHP Billiton) for CMSA; whilst SRK has not re-estimated the Mineral Resources and Ore Reserves, SRK has performed all necessary validation and verification procedures deemed appropriate in order to place reliance on such information
- Reporting of the 2014 Statements (SRK Depleted) based on depletion adjustments to the 2014 Statements (BHP Billiton)
- Examination, review and where appropriate modification of technical studies and LOMPs completed in respect of the CMSA and all conclusions and recommendations drawn therefrom
- Valuation of CMSA Ore Reserves.

SRK has also assessed the reasonableness of the macro-economic and commodity price assumptions as currently assumed in the projections for inclusion in the 2014 Statements (SRK Depleted), the TEPs and the Valuation for Cerro Matoso mine.

Accordingly, the Company and CMSA have provided technical data to SRK for the purpose of this review and inclusion in the CPR. SRK confirms that it has performed all necessary validation and verification procedures deemed necessary and/or appropriate by SRK in order to place an appropriate level of reliance on such technical information.

In presenting the 2014 Statements (SRK Depleted), the TEPs and the Valuation for CMSA in this CPR, the following apply:

- Measured and Indicated Mineral Resources are inclusive of those Mineral Resources modified to produce Ore Reserves, i.e. they are reported on an “inclusive basis”
- Commodity long-term price (**LTP**) assumptions of US\$7.90/lb Nickel for the valuation of Ore Reserves
- Consensus market forecasts (**CMF**) which currently projects a range of US\$9.39 – 8.80/lb Nickel
- SRK has not included any consideration of Inferred Mineral Resources in determining the Valuation for Cerro Matoso Ore Reserves. The exclusion of these sources of potential value as well as the exclusion of a premium or discount related to market, strategic or other considerations means that the Valuation does not reflect a Fair Market Value.

1.5 Limitations, reliance on information, declaration, consent and cautionary statements

1.5.1 Limitations

Ore Reserve estimates are based on many factors, including in this case, data with respect to drilling and sampling. Ore Reserves are derived from estimates of future technical factors, operating and capital expenditures, product prices and the exchange rate between the various currencies and the United States dollar (US\$.) The Ore Reserve estimates contained in this report should not be interpreted as assurances of the economic life of CMSA. As Ore Reserves are estimates based on the factors and assumptions described herein, future Ore Reserve estimates may need to be revised. For example, if production costs increase or product prices decrease, a portion of the current Mineral Resources, from which the Ore Reserves are derived, may become uneconomical to recover and would therefore result in lower estimated Ore Reserves. Furthermore, should any of the assumed factors change, the 2014 Statements (SRK Depleted), the TEPs and the Valuation for Cerro Matoso Ore Reserves as reported herein may need to be revised and may well result in lower estimates. The 2014 Statements (SRK Depleted), the TEPs, and the Valuation for Cerro Matoso Ore Reserves include a number of forward-looking statements. These forward-looking statements are estimates and involve a number of risks and uncertainties that could cause actual results to differ materially.

The achievability of the projections of TEPs as included in this CPR and incorporated into the Valuation for CMSA Ore Reserves is neither warranted nor guaranteed by SRK. The projections as presented and discussed herein have been proposed by CMSA's management and adjusted where appropriate by SRK, and cannot be assured; they are necessarily based on economic assumptions, many of which are beyond the control of the Company and CMSA. Future cash flows and profits derived from such forecasts are inherently uncertain and actual results may be significantly more or less favourable. Unless otherwise expressly stated, all the opinions and conclusions expressed in this CPR are those of SRK.

1.5.2 Reliance on information

SRK has relied upon the accuracy and completeness of technical, financial and legal information and data:

- Furnished by or through the Company, including information and data originating from CMSA; and
- In respect of all aspects relating to CMSA, publicly available information published by BHP Billiton from time to time, including and not limited to any Mineral Resource and Ore Reserve statements and any technical studies contained in such information or data.

The Company has confirmed to SRK that, to its knowledge, the information provided by it (when provided) was complete and not incorrect or misleading in any material respect. SRK has no reason to believe that any material facts have been withheld.

Whilst SRK has exercised all due care in reviewing the supplied information, SRK does not accept responsibility for finding any errors or omissions contained therein and disclaims liability for any consequences of such errors or omissions.

SRK's assessment of CMSA's Mineral Resources and Ore Reserves, TEP forecasts and the Valuation for CMSA's Ore Reserves is based on information provided by the Company and CMSA throughout the course of SRK's investigations, which in turn reflect various technical economic conditions prevailing at the date of this report. In particular, the Ore Reserves, the TEPs and the

Valuation for CMSA's Ore Reserves are based on expectations regarding the commodity prices and exchange rates prevailing at the Effective Date of this CPR. These TEPs can change significantly over relatively short periods of time. Should these change materially, the TEPs could be materially different in these changed circumstances. This CPR specifically excludes all aspects of legal issues, marketing, commercial and financing matters, insurance, land titles and usage agreements, and any other agreements and/or contracts that CMSA may have entered into.

This CPR includes technical information, which requires subsequent calculations to derive subtotals, totals and weighted averages. Such calculations may involve a degree of rounding and consequently introduce an error. Where such errors occur, SRK does not consider them to be material.

1.5.3 Declaration

SRK will receive a fee for the preparation of this report in accordance with normal professional consulting practice. This fee is not dependent on the findings of this CPR and SRK will receive no other benefit for the preparation of this CPR. SRK does not have any pecuniary or other interests that could reasonably be regarded as capable of affecting its ability to provide an unbiased opinion in relation to the Ore Reserves, the TEPs, the Valuation for CMSA's Ore Reserves and the projections and assumptions included in the various technical studies completed by CMSA, opined upon by SRK and reported herein. Neither SRK, the Competent Persons (identified under Section 1.6) or the Competent Evaluators (identified under Section 1.6) who are responsible for authoring this CPR, nor any Directors of SRK have at the date of this report, nor have had within the previous two years, any shareholding in the Company, (except as detailed below), or any other economic or beneficial interest (present or contingent) in any of the assets being reported on. SRK is not a group, holding or associated company of the Company. None of SRK's principals or officers are officers or proposed officers of any group, holding or associated company of the Company. Further, no Competent Person or Competent Evaluator involved in the preparation of this CPR is an officer, employee or proposed officer of the Company or any group, holding or associated company of the Company.

In terms of review documentation, SRK Consulting (Australasia) has reviewed a report (*Definition Phase Study - Hydrogeology and Groundwater Modelling Report - Cerro Matoso, Colombia, 2011*) prepared by SRK Consulting (U.S.), Inc. in 2011 as background for the preparation of the CPR. This report on hydrogeology was prepared by SRK USA. The review by SRK Consulting (Australasia) has been carried out fully independently of this original report preparation.

Consequently, SRK, the Competent Persons and Competent Evaluators and the Directors of SRK consider themselves to be independent of the Company, its directors, senior management and Advisors. In this CPR, SRK provides assurances to the Board of Directors of the Company, in compliance with the Requirements and specifically the Reporting Standard that the Ore Reserves, the TEPs, including production profiles, operating expenditures and capital expenditures of CMSA as provided to SRK by the Company and reviewed and, where appropriate, modified by SRK are reasonable, given the information currently available.

SRK declares that at the time of reporting, the following Competent Persons held personal shareholdings in BHP Billiton:

Danny Kentwell: 1401 shares.

1.5.4 Consent

SRK has given and has not withdrawn its written consent to the inclusion in the South32 Limited Listing Documents of this CPR.

1.6 Qualifications of Consultants, Competent Persons and Competent Evaluators

SRK is an associate company of the international group holding company SRK (Global) Limited. The SRK Group comprises over 1,500 staff, offering expertise in a wide range of resource engineering disciplines with 50 offices located on six continents. The SRK Group's independence is ensured by the fact that it holds no equity in any project. This permits the SRK Group to provide its clients with conflict-free and objective recommendations on crucial judgement issues. The SRK Group has a demonstrated track record in undertaking independent assessments of resources and reserves, project evaluations and audits, Mineral Experts' Reports, Competent Persons' Reports, Mineral Resource and Ore Reserve Compliance Audits, Independent Valuation Reports and independent feasibility evaluations to bankable standards on behalf of exploration and mining companies and financial institutions worldwide. The SRK Group has also worked with a large number of major international mining companies and their projects, providing mining industry consultancy service inputs.

SRK also has specific experience in commissions of this nature.

This CPR has been prepared based on a technical and economic review by a team of 10 consultants sourced from the SRK's offices in Australia and Chile over a 2-month period. These consultants are specialists in the fields of geology, resource and reserve estimation and classification, open-pit mining, geotechnical engineering, mineral processing, hydrogeology and hydrology, tailings management, infrastructure, environmental management and mineral asset technical valuation. Danny Kentwell, Carl Murray, John Reid and Maria Ines Vidal visited the site for a total of three days during the week commencing 3 November 2014.

- Danny Kentwell, MSc (Mathematics & Planning), BAppSc (Surveying), FAusIMM – Geology and Mineral Resources
- Carl Murray, BEng (Mining), MAusIMM – Mining and Ore Reserves
- Ian de Bruyn, BSc Hons (Engineering Geology), Pr.Sci.Nat., MAusIMM – Geotechnical engineering
- Luke Esprey, MSc (Hydrology), PhD (Modelling), Pr.Sci.Nat., MAusIMM - Hydrology
- David Western, MSc (Hydrogeology), MIAH, MAusIMM, MIMWA, MAWA – Hydrogeology
- John Reid, BSc (Hons) Metallurgy, PhD (Metallurgical Engineering), MBA – Metallurgical processing
- Dave Luppnow, BSc (Civil Engineering), PE (Washington) – Tailings
- Maria Ines Vidal, BSc (Geography), MAusIMM – Environmental
- Anthony Stepcich, BEng, MSc, GDip (Finance & Investment), Dip (Technical Analysis), MAusIMM(CP) – Technical valuation
- Trivindren Naidoo, MSc Exploration Geology, Pr.Sci.Nat., MAusIMM, MGSSA
- Peter Fairfield, BEng (Mining), FAusIMM – CPR review.

The Competent Person who has reviewed the Mineral Resources as reported by BHP Billiton is Mr Danny Kentwell, MSc (Mathematics & Planning), BAppSc (Surveying), who is an employee of SRK. He is a Fellow of The Australasian Institute of Mining and Metallurgy within the meaning of the JORC Code. Danny Kentwell is a geostatistician with over 25 years' experience in the mining industry and has been involved in the reporting of Mineral Resources on various properties internationally during the past 12 years.

The Competent Person who has reviewed the Ore Reserves as reported by BHP Billiton is Mr Carl Murray, BEng (Mining), who is an employee of SRK. He is a Member of The Australasian Institute of Mining and Metallurgy. Mr Carl Murray is a mining engineer with over 25 years' experience in the mining industry and has been involved in the reporting of Ore Reserves on various properties during the past 15 years.

The Competent Person and Competent Evaluator is Mr Anthony Stepcich, MSc (Mineral Economics), BEng (Mining), Grad Dip (Finance & Investment), Dip (Technical Analysis), MAusIMM (CP), who is an employee of SRK. Mr Anthony Stepcich is a mining engineer with over 21 years' experience in the mining and metals industry and has been involved in the preparation of Competent Persons' Report comprising technical valuations on various mineral assets internationally during the past nine years. Mr Stepcich assumes the responsibility for the estimates presented and has the relevant experience to be considered an Expert under the VALMIN Code guidelines. Mr Stepcich did not visit site and has relied on site visit reports of SRK specialist who visited site and carried out a technical review.

2 Overview

2.1 Property description

CMSA is an open pit lateritic nickel mine that is located 25 km south west of the town of Montelíbano, in Cordoba Province, northern Colombia. The operation consists of an open pit and associated smelter and refinery that produces ferronickel granules that are exported through the Caribbean port of Cartagena 260 km to the north. Annual production is approximately 3 million tonnes per annum (Mtpa) of ore feed to the processing plant.

The site is in a semi-tropical environment, with a mean annual precipitation of about 2,500 mm.

2.2 Property rights

CMSA has exploration and exploitation rights in an area of 52,850 hectares denominated 051-96M contract.

In December 2012, an amendment to the contract was agreed, known as the Otrósí N° 4. Pursuant to the Amendment, the concession period is extended for an additional 15 years up to 1 August 2044 subject to CMSA increasing, directly or indirectly, the dry ore processing capability from 3.0 Mtpa up to 4.5 Mtpa, within a 10-year period of formalisation of the agreement (December 2012), otherwise it will expire in 2029 with the possibility of applying for an extension. The area of concession under Contract 051-96M, is shown in Figure 2-1.

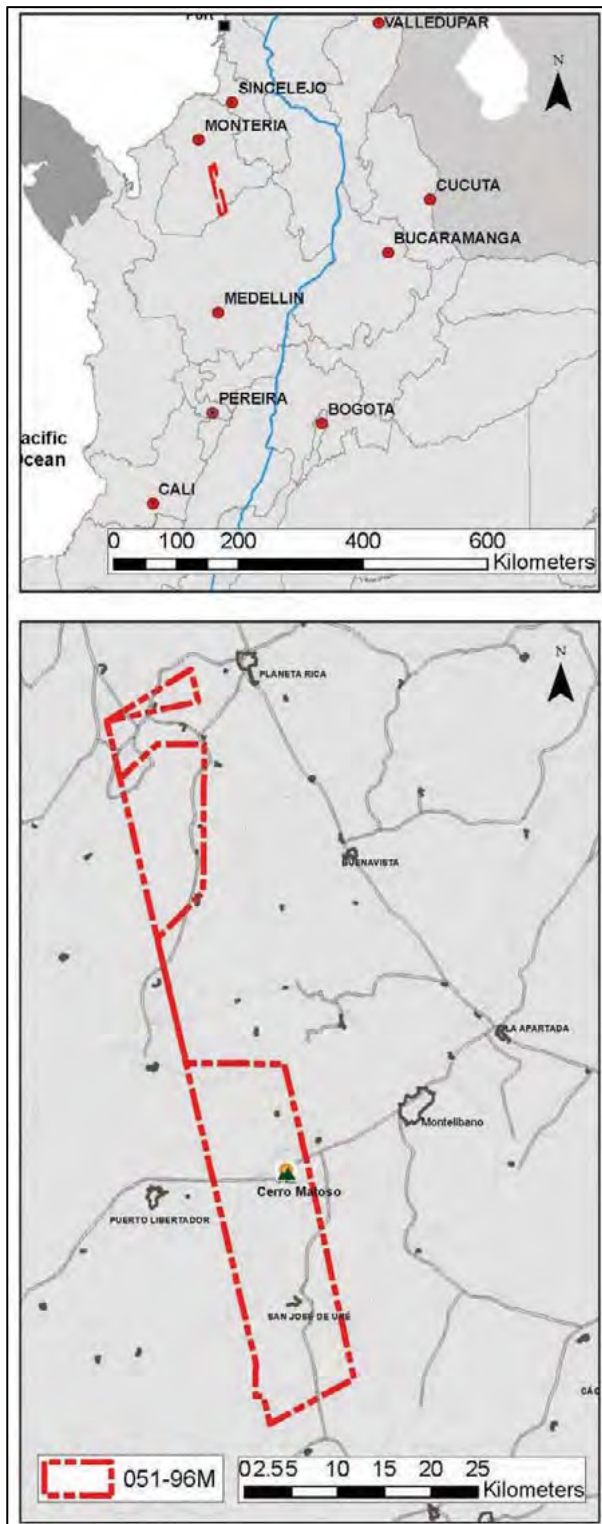

Figure 2-1: Area of Mining Concession Contract 051.96M

Key aspects of Otrosí N° 4 are as follows:

- Acknowledges the incorporation of the Mining Concessions' area into Contract 051;
- Confirms (a) CMSA's right to continue exploitation of the Mining Concessions' area, from October 1, 2012; (b) CMSA's right to continue exploring and, upon expiry of the exploration stage, exploiting nickel and other associated minerals, minerals in the same league, or obtained as by-products of these minerals; and (c) CMSA's right to explore and exploit coal (and processing nickel) on the 52,164 ha (i.e. excluding the Mining Concessions' area);

- Extends Contract 051's duration from 2029 to 2044, subject to CMSA achieving an expansion of its processing capacity from 3 to 4.5 million dry tons (Mdt) per year, within 10 years following the registry of Amendment 4 with the Mining Registry; the expansion of the processing capacity shall be evidenced by means of an independent auditor;
- Postpones the reversion of the Mining Concessions asset's until 2044 (to then be leased back to CMSA under agree terms and conditions);
- Extends the exploration stage on the 52,164 ha (i.e. excluding the Mining Concessions' area) from 2015 to 2020; and
- Provides for additional financial compensations and social investment by CMSA.

2.3 Permits and approvals

Based in the information reviewed and interviews with CMSA personnel, CMSA has all necessary approvals to carry out its current activities. In regard to potential expansion plans, the only pending approval is the environmental license for Project Esmeralda, as described in Section 13.

3 Geology

The June 2014 BHP Billiton Cerro Matoso Competent Person's Report (Version 4.1), in conjunction with observations by SRK and discussions with CMSA staff whilst on site during November 2014, have been used as the basis for this review.

3.1 Geological setting

The CMSA deposit is located to the south of Cordoba and north of Antioquia provinces, where three peridotite bodies are present in a north-south orientation, referred to as the Cerro Matoso nickel belt. The peridotites are associated with a Cretaceous ophiolite complex, located along the northern extension of the regional NNE–SSW-oriented Cauca-Romeral fault system. Tertiary age argillaceous sediments with local coal horizons surround the peridotites.

The peridotites are present in the following areas (Figure 3-1):

- Cerro Matoso mine area, comprising the current mine and possible extensions below sedimentary cover;
- Planeta Rica License area, located 40 km north of Cerro Matoso mine; and
- Uré License area, located 15 km south of Cerro Matoso mine.

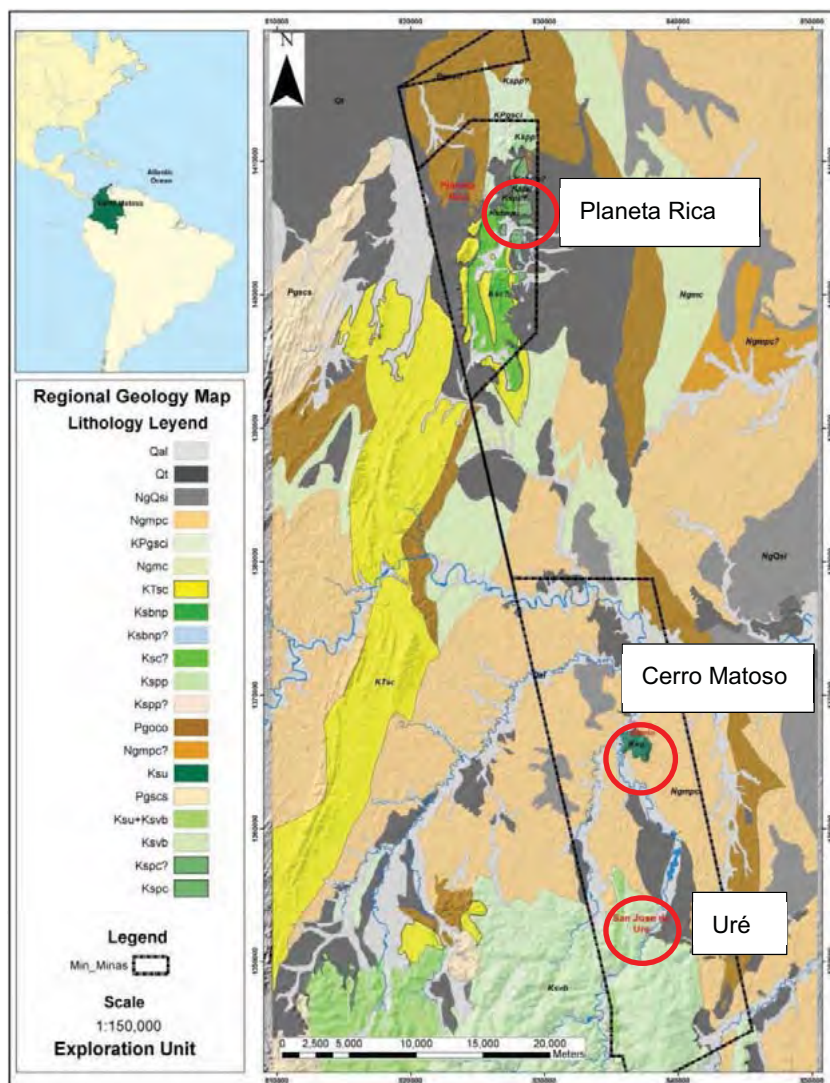

Figure 3-1: Regional geological setting

Source: CMSA (2014)

3.2 Deposit Geology and structure

The local geological setting of Cerro Matoso is characterised by a complex set of rock types that have been grouped into a number of major rock sets.

This geological basis for the rock type grouping is critical, as the local laterite profile is characterised not only by the evolutionary products of a typical tropical laterite weathering profile, but by several unique lithologies that also occur, including tachylite and very dark (black) saprolite units.

The resulting vertical layering is based on common physical and chemical features and from top to bottom consists of four zones – a sedimentary cover, a limonitic zone, a saprolitic zone and fresh peridotite bedrock. The rock types are described below. Groups of rock types forming rock sets are defined in Table 3-1 and a typical rock set profile is shown in Figure 3-2.

Table 3-1: Rock types and rock sets

		Rock type	CMSA Code	Density	Ni	Fe	MgO	SiO ₂	Al ₂ O ₃	Rock set Definition			
Laterite	Limonites	Mudstones	14	1.63	<0.02	06-08	<1	>50	>15		7	Overburden Waste	
		Canga	Canga Mona	13	1.83	<0.8	30-37	<1	10-20	>10			1
			Canga	10	2.25		45-48		<20	>10			1
		Limonite	Laterite	20	1.20	<0.8	20-37	<1	20-55	6-12			1
	Silica		80	1.50	<20		<1	>60			1		
	Transition	High Fe laterite	24	1.04	0,8-1,4	37-50	0,8-2	<20	6-10	Low MgO / High Fe	2	Lean ore	
		Black Saprolite	44	2.39							2		
		Taquilita	43	1.37							2		
		Reworked material	43	1.57		25-37		20-45	<7		2		
		Brown Saprolite	30	1.23		1,5-2,5		15-35	2-8		10-45		<5
	Saprolites	Saprolite	Green Saprolite with Low MgO	42	1.54	1,5-3,5	12-30	8-20	20-45	<5	Intermediate MgO	4	High Ni ore
			Green Saprolite with High MgO	40	1.75		08-15	18-26	30-40	<3		4	
		Weather bedrock	Saprolised Peridotite	50	2.09	>0,4-0,7	>12	24-30	35-50	<2	High MgO	5	Upgradeable
	Bedrock	Peridotite	Bedrock	Peridotite	60	2.62	<0.4	6-7	>35	40-50	<1	6	Waste

Source: CMSA (2014)

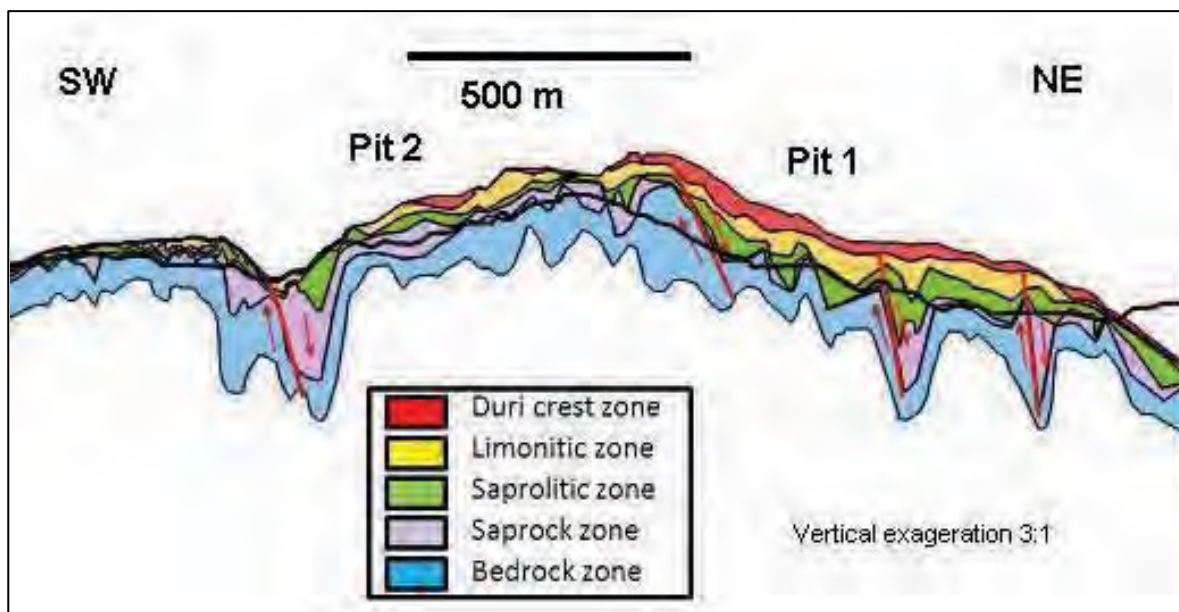

Figure 3-2: Typical rock set profile

Source: CMSA (2014)

3.2.1 Sedimentary cover

Clay and Mudstone (14): Soft recent sedimentary rocks ranging in colour from grey, black, yellow and red mudstones, with common organic matter to mature grey and white sands and poorly selected conglomerates which include Quartz and Peridotite boulders. Coal fines horizons are common. This unit appears in the lower parts and all around Cerro Matoso hill, overlapping altered ultramafic rocks. The Ni content is lower than 0.2%.

3.2.2 Limonitic zone

This zone is the top part of the weathering profile; it has a low MgO content due to leaching and downward movement of groundwater. Fe and Al₂O₃ are high due to their more stable behaviour in the weathering environment. The original texture of the rock is completely lost, and with the exception of Canga, all rocks are weakly consolidated. Silica enrichments (veins and box works) are common especially towards the base of the unit.

Canga (10): A very hard, deep red-brown Duricrust or Ferricrete-type rock, with iron oxide nodule concentrations in a silty-clay matrix. This is the product of the most advanced weathering stage of the original Peridotite. Ni content is not usually greater than 1.0%; there is no associated free silica.

Canga Mona (13): A light brown variation of Canga; not as hard as Canga and without iron oxide nodule concentrations. This rock type looks like a lateral variation of Canga with lower Fe and SiO₂ contents. Ni content is not usually greater than 1.0% and there is no associated free silica.

Laterite (20): Yellowish to red in colour, earthy textured soft and light material with common free silica associated in box work structures. It appears in the top and exposed parts of the deposit, Ni content greater than 1% is uncommon.

Silica (80): Appears over almost the entire sequence as veins or box works structures, but is predominantly associated with the limonitic level of the weathering profile. Amorphous quartz like Jasper or Chalcedony is present.

High Fe Laterite (24): Deep red to orange in colour, plastic non-consolidated material with common surface Mn oxides and small spherules of Magnetite. This rock type can be in the top of the

sequence or underneath Canga in contact with Saprolitic level. Ni content is around 1.2%.

Chemical composition similar to Canga but Ni and Al₂O₃ content is higher. MgO content is lower than 1.5%. No free silica is associated.

3.2.3 Saprolitic zone

This zone contains moderate levels of weathering. The rocks show evidence of the fabric of the original peridotite. Fe and Al₂O₃ are more variable than the Limonite level; MgO is more common and Ni content is also increased.

Brown Saprolite (30): Light brown to red or yellow green, very plastic and soft material, with remnants of the original fabric. It is usually found between Limonite and deeper Saprolites. Association with high MgO rocks is common. It is in the top of the saprolitic sequence, where present, as a transition rock with Limonites. Ni contents are usually greater than 1.5%. Fe content is also greater than 16% and sometimes up to 40%. MgO is between 3% and 10%. Associated free silica is not common.

Tachylite (43): Black to dark green, fragile, light rock with a slicken-sided fault material or carbon-rich organic matter appearance. It is almost always associated with the top of the Saprolitic sequence where altered rock is beneath recent and tertiary sediments. Ni content is between 0.6 and 1.2%. It is normally above the low MgO green Saprolite or in transition with it.

Black Saprolite (44): Deep dark green or black clayish, heavy, medium hard material with remnants of the original fabric. This rock type usually occurs between the surface high Fe limonite and deeper saprolites. Ni contents ranges from 0.8 to 1.4%. Fe content is similar to high Fe laterite (up to 45%). MgO is also between 0.8 to 1.4%. Associated free silica is not common.

Low MgO green Saprolite (42): Dark green to dark brown, medium hard, with Fe and Mn oxides and silica veins. Ni content is usually high and this rock type has historically formed the main feed material for the metallurgical process. It is below brown or black Saprolite, where present, or in contact with the lateritic zone. The nickel content is associated with Garnierite and Smectite.

High MgO green Saprolite (40): Light to dark green, compact, hard rock commonly with Peridotite nucleus. It is different from the previous Saprolite in that it has lower Fe and higher MgO contents. This rock type is usually in contact with Saprolitised Peridotite. Ni contents are similar to low MgO Saprolite, so it is an important material for the metallurgical process. It is underneath low MgO Saprolite. The nickel content is associated with Garnierite and Smectite.

Saprolitised Peridotite (50): This is the first product of the lateralisation process over the original Peridotite. It is pale yellow to green/black in colour. The fabric is like the original fresh rock, but with small amounts of clay minerals in fractures, joins or borders. MgO is usually greater than 24%.

3.2.4 Fresh rock

Peridotite (60): Dark green to black, hard and heavy Harzburgite with olivine and orthopyroxenes. Ni content is below 0.7%. When the Ni content is greater than 0.7% it is because it is associated with Garnierite veins. Magnesite veins are also common.

3.2.5 Structure

The CMSA deposits have been developed in a tectonically very active environment that has been subjected to a high level of shearing during emplacement and possibly during laterite formation. Ni grades appear to have some structural relation.

Lithological distribution is influenced by:

- Variations in bedrock characteristics
- Topography
- Faults, which occur in two principal directions (NW and NE).

Contacts between lithologies at Cerro Matoso can range from sharp contacts of as little as 10 cm, to diffuse contacts grading over tens of metres. These contacts reflect the structural control on weathering. An overall decrease in weathering is observed at depth, sub-parallel to the topography in a blanket like effect resulting in gradational sub-horizontal contacts, particularly at shallower depths in the deposit.

Two principal fault directions occur at Cerro Matoso. The dominant system is a NW-trending wrench fault system with normal faults and associated joint sets striking between N30°W and N55°W, with dips of >75° to the NE. Faults and joints related to the NW-trending system are persistent and dominant in the lower benches, particularly in Pit 2. Garnierite veining occurs predominantly in NW-oriented joints of average 1.5 cm width and with low persistence (3-4 m).

The NE-trending fault system is associated with normal faults and joint sets striking between N10°E and N57°E and dips averaging 67° to the SE. Structures occur predominantly in the low MgO green Saprolite, followed by high MgO green Saprolite, with fewer structures visible stratigraphically above and below this.

The structures transgress all lithological units, but are most visible and influential in the saprolite units where the greatest lateral contrast exists in weathering.

3.2.6 Transported material

In addition to the *in situ* Laterites, there are also areas surrounding the main deposit that contain horizons of transported material that in some areas carry potentially economic grades. In some cases, these will underlie barren alluvials which in turn overlay *in situ* Laterites.

3.2.7 Mineralisation

The principal mineralisation types consist of Saprolite containing Serpentine and Ni-bearing Smectite as well as Ni-bearing Goethite. The bulk of mineralisation at Cerro Matoso is found in the low MgO green Saprolite. Mineralisation is also present in high MgO green Saprolite, black Saprolite, brown Saprolite and Saprolitised Peridotite. Other lithologies have lesser amounts of mineralisation.

Mineralisation in the form of fracture filling garnierite (with locally very high Ni grades) is also present in veins in the lower lithologies of the profile such as in green Saprolite and Saprolitised Peridotite.

3.3 Summary comments

In the upper levels of the weathering profile the basement structures have not played a major part in the mineralisation controls with the sub horizontal weathering being dominant. Recent bench mapping (Figure 3-3) has defined the rock types in the exposed faces and floors resulting in a detailed picture of the influence of the structures on the weathering and rock type. These structures are significant as they are capable of extending partially weathered Ni mineralisation up to 100 m or more below the current pit floor bedrock where present. Figure 3-4 shows the June 2013 pit floor, the Ni grade contours, the current drilling and the interpreted structures (the Ni contours and interpreted structures were created by SRK from the CMSA supplied drilling database). The reduced influence of weathering and the increased influence of the structure on the rock type variability at the current pit floor is a major factor in the reconciliation issues experienced in recent years (refer also to Section 4.1.12).

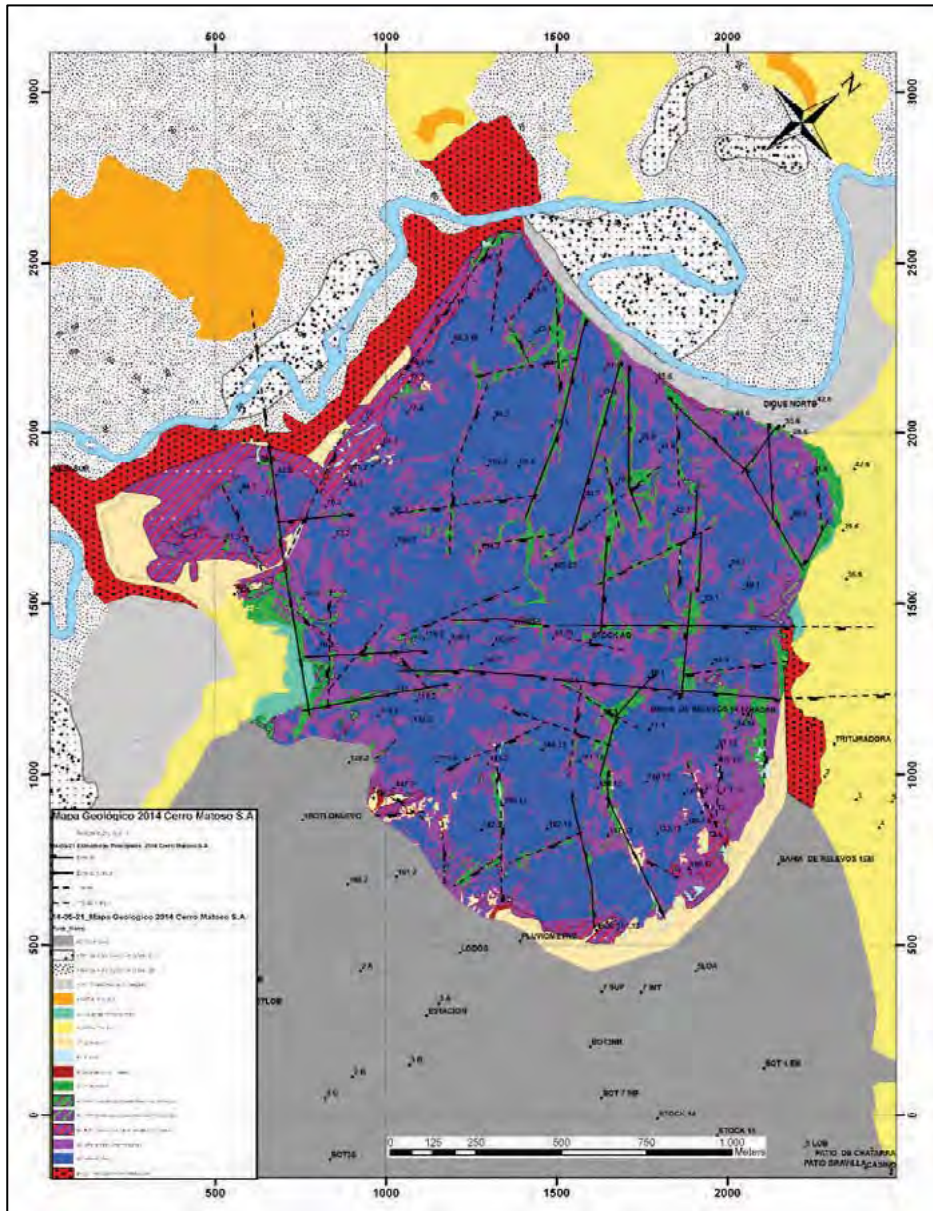

Figure 3-3: Bench mapping of rock type and structures

Source: CMSA (2014)

Notes: Green = Sapolrite; purple = Sapolitised Peridotite; blue = Peridotite

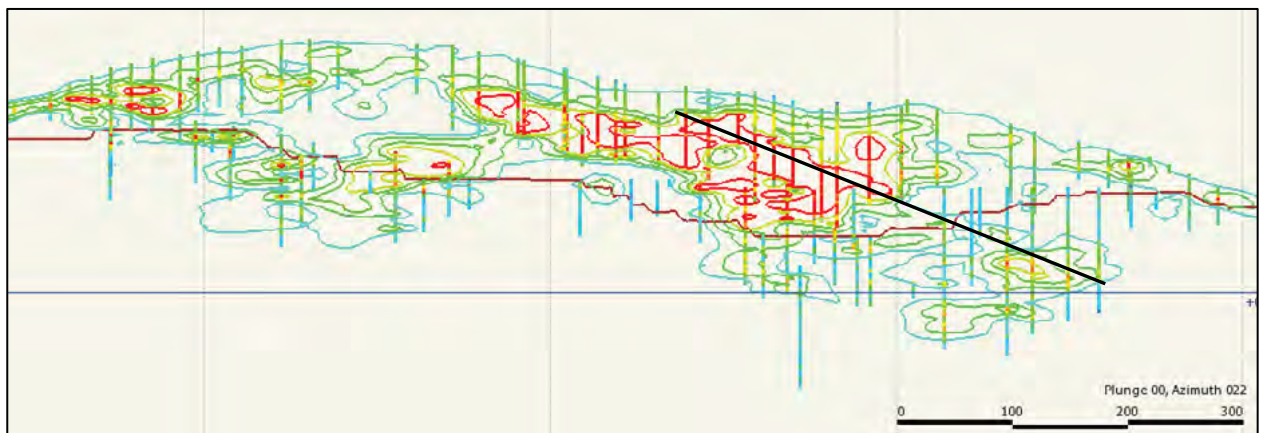

Figure 3-4: Section showing structurally related depth extensions

4 Mineral Resource and Ore Reserve

4.1 Mineral Resource Estimation and Classification

It should be noted that this review is based on a 2011 Resource model utilising drilling data to December 2011 only. The current July 2014 publicly reported Resource is derived from the 2011 model, constrained by optimistic pit optimisation parameters as at June 30 2013 and depleted for mining to June 30 2014. An updated 2014 Resource model is currently under development.

The Resource is made up of both *in situ* mineralisation as well as stockpiled material from the pit. A small proportion of the Resource is also made up of post-processing slag rejects which have some potential to be re-treated.

4.1.1 Data acquisition

The drillhole estimation database used for the current Resource includes samples compiled over 30 years of drilling until 31 December 2011, defined by more than 6,250 holes with more than 131,000 records, each with seven chemical variables (Ni, Fe, MgO, SiO₂, Al₂O₃, Co and CaO) plus rock type assignation, rock set and region/domain classifications. The density database used contains 2,024 samples collected in a series of six sampling campaigns.

Sampling is predominantly from wet reverse circulation (RC) drilling obtaining 2 m samples. Rock chips and fine material are taken from the rotary sampling device attached to the cyclone of the drill rig. The sub-sample represents about 50% of the total sample. The sample is decanted and re-sampled at the lab into 4 kg samples. The 4 kg sub-sample at the lab is dried and pulverised and split. Around 1 gram is fused in Borate glass discs and analysed by XRF.

Wet RC drilling is used for sample collection. This technique employs a double-walled string of drill rods, with a quickly rotating tungsten carbide coring bit at the business end of the drill string. The drilling medium (water) is supplied to the cutting bit down through the twin-walled drill string and carried up back to the surface through the centre of the drill rods; the nominal hole diameter is 5"1/4.

The rock fragments are flushed out through the hollow tubing; the rock chips and fluids are split at the cyclone at 50:50 then captured in large buckets of around 25 litres. These buckets are then taken to the lab mostly decanted (by gravity) and sub-sampled before being dried and analysed.

With this method of drilling, around 50% of the rock sample is collected (10 kg), of which ~3 - 4 kg (20% of original) is used for the lab analysis. The method is very quick and minimal contamination to the sample as it is transferred back to the surface occurs.

The Cerro Matoso deposit has been drilled with vertical holes on a local metric grid system (NE-NW system) linked to the regional coordinate system. The local metric grid system has a clockwise rotation of 51° 59' 35" from the National Grid System (Observatorio Astronómico Bogotá).

Digital global positioning satellite (DGPS) equipment is used to survey collar holes and density point samples. Using this equipment has an error of up to 0.1 m in a fixed signal and up to 5 m in a floating point signal; this is used only in very isolated points outside of the Main Pit. About 1% of drillhole collars have been surveyed in a floating point mode. Drillhole spacing is 25 m at most; therefore DGPS provides suitable accuracy and precision.

Routine sampling and geological logging of all exploration chip samples is undertaken at the time of drilling, and is recorded through a set of rock type codes in the drilling database (Table 3-1). Since exploration commenced in the 1970s, several Resource Models have been built; however, no systematic verification of the original logging or correlation with the revised rock type classification system has been undertaken.

Sample preparation is done by CMSA internal laboratory, following established protocols.

Assay routines have been established, normalised and documented in order to comply with the relevant international standards. The CMSA assay laboratory implements routines for checking the results on a daily basis by checking standards during assaying and calibrating equipment at the start of each shift. In addition, the CMSA lab is technically compliant with ISO 17025 standards and complies with ISO 9000 certification.

Annual internal audits and 2-year external audits are performed in the lab to verify the entire process (manager system audits).

Standards, blanks, duplicates and external laboratories checks have been established as quality control procedures; +/-10% relative difference has been established as an acceptable level of accuracy and precision. Additionally, precision, accuracy and non-compliance is tracked through client claims reports.

Samples are assayed at the Cerro Matoso laboratory by X-Ray fluorescence (XRF) for 15 chemical variables. The database includes the assay result for the following elements/components: Ni, Fe, MgO, SiO₂, Al₂O₃, Cr, Mn, CaO, Co₃O₄ and Ca. The XRF assay uses fused pellets prepared with 0.8 g of sample and 8 g of lithium tetraborate in Pt crucibles. The analysis does not include loss on ignition (LOI). However, the oxide balance for each sample is calculated, and if the result does not reach 80%, then the laboratory is requested to assay the LOI.

In order to check accuracy and no contamination, certificated reference materials (CRMs) and pulp blanks are submitted for analysis at a rate of 1:50 samples. These are also analysed externally. A collection of four CRMs is used with a range of Ni values from sub-ore grade to ore grade material. These are also analysed at one external lab as a check on accuracy. Their results are plotted over time to search for any bias or poor correlation with time.

Checking is performed by plotting the absolute relative difference (ARD) between both assays; to accept the entire batch, 90% of the population must be below 5%ARD.

The Resource database was reviewed for mass balance and rock type assignment. With respect to the mass balance, special care was taken to ensure that the values do not exceed the normal limits of the sum of oxides being 80% - 105%.

4.1.2 Geological modelling

The geological interpretation comprises bounding surfaces based on geochemical rock sets, described in Section 3.2.

The rock sets were then used to construct a set of bounding surfaces to constrain geological and modelling parameters in the vertical direction. Creation of the surfaces allows some intercalated rock types to be within a given rock set in order to simplify the geology. A hierarchy was enforced so that each rock set surface occurred only once. The rock sets from surface to basement are coded as 1, 2, 4, 5 and 6 (Figure 3-2 and Table 3-1). Horizontal domaining of data was performed by dividing the deposit into nine regions/domains.

4.1.3 Resource estimation

The Mineral Resource extent in the Cerro Matoso deposit is around 3 km long by 2 km across following the weathered hills, whereas transported material surrounding the mine area, extends out past 3 km distance and up to 5 km in places. The Mineral Resource maximum height is 181.5 m above sea level and the Mineral Resource lower depth is -280 m relative level (RL).

Ordinary Kriging technique is used for grade estimation. Top-cuts have been used for extreme

grade values (less than 0.1% of data). Nine areal domains/regions and five rock sets have been used for domaining. Interpolation parameters are defined for each areal domain and rock set.

Separate models were created in *Datamine* for each rock set using the corresponding wireframed surfaces. The parent block size is 12.5 m E by 12.5 m N by 7 m RL.

After block grade and rock type estimation, the five models were combined to produce a single model containing all five rock sets (i.e. rock sets 1, 2, 4, 5 and 6) and referred to as the Combined Model.

CMSA uses an unfolding or flattening process prior to estimation. The “unfolding” convention applied is the standard unfolding as incorporated in *Datamine* software. The Easting and Northing co-ordinates of the input data have been retained as they are, but the vertical (elevation) co-ordinate has been unfolded and normalised (i.e. range from 0 to 1).

CMSA defined top and bottom surfaces of all individual rock sets and defined the major directions (azimuths) of the three co-ordinate axes used by *Datamine* to control the along-strike and down-dip co-ordinate conversion matrix. As a result, the Z-axis (elevation) co-ordinate is normalised to a space bounded by minimum and maximum values of 0.0 and 1.0 that conform to the bottom and top positions of both drillhole samples and model blocks at every possible individual location with the unfolded space.

In this manner, both input data and model blocks are estimated using the unfolded sample information and back-transformed to its original location after the estimation has been completed in unfolded space. Note that drillhole data and block models for each rock set are unfolded independently using the corresponding hanging wall and footwall wireframes.

A complete variography analysis was performed in order to obtain estimation parameters for each rock set; this analysis involved a total of six attributes: Ni, Fe, MgO, SiO₂, Al₂O₃ and Co for all regions/domains (i.e. nine regions/domains) within each rock set (i.e. five rock sets).

A simplified approach to variogram modelling was adopted:

- All variograms were modelled in EW, NS and normalised Z directions
- Absolute variograms were standardised to a theoretical sill of 1
- All variograms modelled with three spherical structures.

Hard boundaries between the rock sets and domains/regions were applied during estimation of block grade values.

Top-cuts

Top-cutting was applied to economic minerals Ni and Co based on inflexion points on cumulative log probability plots normally above the 99% cumulative percentile.

Although some extreme grades were observed for the major oxides (Al₂O₃, Fe, MgO, and SiO₂), it was decided to maintain the original values to preserve the oxide totals so as not to influence Al₂O₃, Ni: Fe, Si: Mg that have a significant impact on metallurgical performance or rock type assignment.

Density data

Average dry density values for each rock type were used based on 2,024 readings compiled from several campaigns detailed below.

The initial density determinations utilised by CMSA comprise a historical database of 433 samples (Campaign 1) which were used for the 2001 Resource Model. The 2002 density data consisted of 421 additional density determinations (Campaign 2) that correlated well with the initial 433 sample database, with the exception of laterite and high-Fe laterite rock types, which show significant

increased density readings.

During 2003, a third sampling campaign for density measurements was performed; ~1,600 samples were collected. Due to the results being significantly lower than previous campaigns, this last dataset underwent an extensive process of checking. In the end, 1,103 new density data points were added to the official density database, totalling 1,957. However, it was evident that the difference between the two initial datasets and the third would have a significant effect on the overall density results.

Despite the large number of samples taken in 2003, the small size of the samples from Campaign 3 possibly had a high bias in moisture content measurements – a re-designed sampling campaign was therefore implemented, this time increasing the size of the samples to 3 litres. This campaign was called Campaign 4; the results seemed to confirm values obtained in Campaign 3.

At this time, there were still significant differences between historical density values and new ones. Two external and one internal audit were performed in order to validate the density dataset. A common finding from those audits was that the size of the sample was too small and density was probably biased as a result.

Sampling methodology and logistics were implemented in order to take 30 litres of material for each sample. This new campaign was called Campaign 5 and the results were closer to historical campaigns 1 and 2 values than values obtained from campaigns 3 and 4.

Simultaneously with this new sampling methodology, a validation method using core sampling density measurements (Campaign 6) was implemented; the results confirmed the values obtained from Campaign 5. With this confirmation, statistical processing was applied to values from campaigns 5 and 6 in order to eliminate outlier values.

4.1.4 Resource classification

Resource classification was based on drillhole spacing, with Measured, Indicated, and Inferred categories representing nominally 25 x 25 m, 100 x 100 m, and 150 x 150 m grids respectively. An automated 3D approach to classifying the blocks for each rock set was adopted as follows:

- Measured – three drillholes within 35 m in the horizontal and 10 m in the vertical
- Indicated – three drillholes within 100 m in the horizontal and 30 m in the vertical
- Inferred – one drillhole within 150 m in the horizontal and 50 m in the vertical.

These criteria are supported by Ni variography and estimation confidence measures such as kriging variance and efficiency. The search was carried out in real 3D space on a block by block basis with the vertical distances required to account for the undulating nature of the mineralisation.

Resource classifications were assigned for each rock set independently; thus, vertical variations in resource classification were permitted, both within and between rock sets. In instances where deep narrow pockets of high grade Ni mineralisation were modelled, the lower part of the pocket was generally downgraded in confidence unless the pocket was defined by three drillholes.

In addition, a smoothing routine was used to ensure that no single isolated blocks of any one classification existed; however, this routine still allows small clusters of isolated classifications to exist.

This resource classification assumes that confidence in the geological interpretation and drilling data is of a corresponding standard. Plan views of the resource classification blocks by rock set are shown in Figure 4-1.

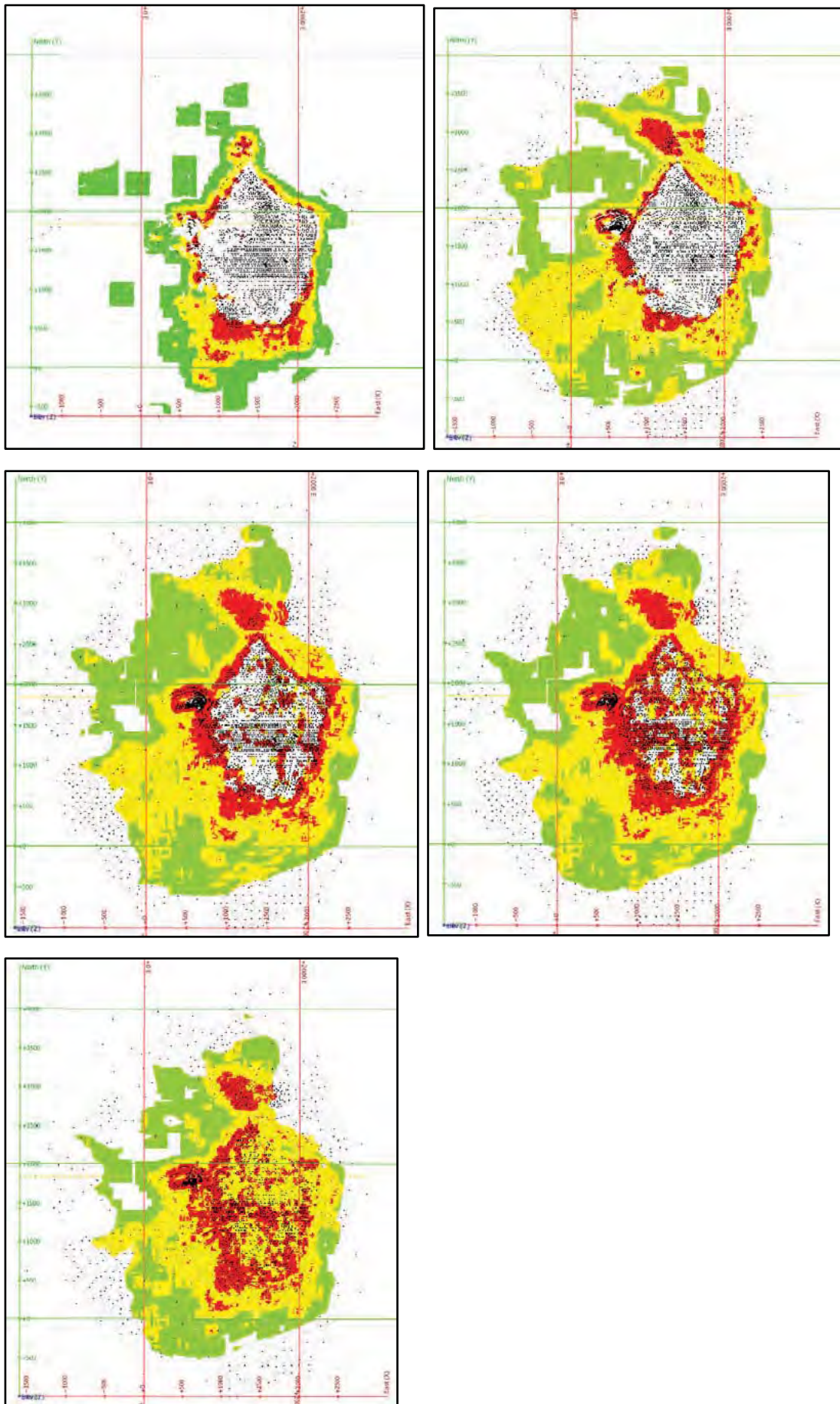

Figure 4-1: Resource classification plan views by rock set 1, 2, 4, 5 and 6

4.1.5 Reasonable prospects of eventual economic extraction

In order to justify reasonable prospects of eventual economic extraction (JORC 2012), CMSA has generated an optimised pit shell considering an optimistic scenario from a mining, processing and economic perspective in the long term.

This pit shell assumes a highest nickel price scenario, low processing cost for pyrometallurgical and heap leach process, access to El Boton, Esmeralda, Pit 2 south and Balsillas areas, as well as the resources located under current dump area and along the river buffer. Additionally, successful mineral processing by hydrometallurgical process (heap leach) is assumed.

The main processing assumption taken into account as at June 2014 was the successful implementation of the heap leaching project (see additional comments in Section 4.1.12).

The current pyrometallurgical plant operating parameters with respect to SiO₂: MgO ratio and Fe and Al₂O₃ limits is assumed, but with an optimistic recovery of 88%.

Cut-off parameters for optimistic pit scenario

The revenue assumptions used in the Mineral Resource estimation are based on BHP Billiton's internal long term commodity price protocols (high case) for the optimisation.

The optimisation and scheduling process used by CMSA takes all constraints into account but may include individual blocks outside specification if they can be blended to create additional economic material that conforms to the process specifications.

The Resource within the optimistic pit is still reported at 0.6% Ni cut-off, as this is the marginal cut-off under current price assumptions.

4.1.6 Model validation

CMSA validation

Validation of the Resource Model has been undertaken by several methods including the following:

- Visual validation of block model coding and estimated block grades versus drillholes
- Comparison between declustered composite and block model statistics
- Swath plots comparing block grades against composite grades.

4.1.7 Stockpile Resource definition

The mineralised stockpiles at Cerro Matoso form a significant part of the current Resource. The grades and tonnages of the stockpiles are classified as Measured. Grades and tonnages of the stockpiles have historically been tracked from the grades and rock types defined by operational grade control models. Some stockpiles have monthly surveyed volumes that are assigned individual grades, others has a single average grade assigned for the entire stockpile. There are currently 18 individually defined stockpiles, some of which are actively being mined. Historical reconciliation of three of the stockpiles shows variations of up to ±15% on tonnage and/or grade. In recent years, stockpile drilling has taken place to conform the composition of the stockpiles identified for short-term mine planning. The stockpile drilling program is ongoing, and all stockpiles are intended to be drilled at some level to confirm their composition. The stockpiles are included in the 2011 resource block model which forms the basis of the 30 June 2014 reported Mineral Resource.

4.1.8 Mineral Resource Statement – 30 June 2014

Table 4-1 presents the 30 June 2014 Mineral Resource that is based on the model completed using drilling data as at 31 December 2011, a survey as at 30 June 2013 and depletion during 2014, that is constrained by an optimistic pit shell. The Mineral Resource Statement is JORC Code 2012 compliant.

Table 4-1: 30 June 2014 Mineral Resource (based on drilling information to 30 December 2011)

Classification	Type	Ore (Mdt)	Ni (%)	Fe (%)	MgO (%)	SiO ₂ (%)	Al ₂ O ₃ (%)
Measured Resource	Laterite	44	1.2	11.8	21.5	42.8	2.3
	Stockpiles	51	1.1	17.0	19.8	37.4	2.1
Indicated Resource	Laterite	179	0.9	18.9	9.4	36.3	4.4
Inferred Resource	Laterite	66	0.8	18.8	9.1	37.2	4.9
Total		340	0.9	17.7	12.5	37.5	3.9
MNR Ore – Measured Resource ⁽¹⁾		17	0.2	-	-	-	-

(1) Slag Stockpile in Metal Nickel Recovery Process (COG 0.12% Ni)

Source: CMSA (2014)

4.1.9 Mineral Resource Statement (SRK Depleted)

SRK has prepared a Mineral Resource (SRK Depleted) as at 31 December 2014, that is based on the model completed using drilling data as at 31 December 2011 depleted for mining to 31 December 2014 and constrained by an optimistic pit shell is presented in Table 4-2. The depletion is based on mine production records between 1 July 2013 and 30 October 2014 and planned production from 1 November to 31 December 2014.

Table 4-2: 31 December 2014 Mineral Resource (based on drilling information to 30 December 2011)

Classification	Type	Ore (Mdt)	Ni (%)	Fe (%)	MgO (%)	SiO ₂ (%)	Al ₂ O ₃ (%)
Measured Resource	Laterite	42	1.2	11.8	21.5	42.8	2.3
	Stockpiles	49	1.1	17	19.8	37.4	2.1
Indicated Resource	Laterite	178	0.9	18.9	9.4	36.3	4.4
Inferred Resource	Laterite	66	0.8	18.8	9.1	37.2	4.9
Total		335	0.9	17.7	12.5	37.5	3.9
MNR Ore – Measured Resource ⁽¹⁾		17	0.2	-	-	-	-

Note:

This report includes information on Mineral Resources (inclusive of Ore Reserves) as reported by C A Rodriguez (MAusIMM). The information is extracted from the report titled BHP Billiton 2014 Annual Report and is available to view on www.BHPBilliton.com.

All Competent Persons are full-time employees of BHP Billiton at the time of reporting and have the required qualifications and experience to qualify as Competent Persons for Mineral Resources under the 2012 Edition of the “Australasian Code for Reporting of Exploration Results, Mineral Resources

and Ore Reserves" (JORC Code). The Competent Persons verify that the report is based on and fairly reflects the Mineral Resources information in the supporting documentation and agree with the form and context of the information presented.

BHP Billiton confirms that it is not aware of any new information or data that materially affects the information included in the original market announcements and, in the case of estimates of Mineral Resources that all material assumptions and technical parameters underpinning the estimates in the relevant market announcements continue to apply and have not materially changed. BHP Billiton confirms that the form and context in which the Competent Persons' findings are presented have not been materially modified from the original market announcements.

The Mineral Resources breakdown by classification (100% basis) is contained in Table 4-1. All tonnes and quality information has been rounded, hence small differences may be present in the totals.

4.1.10 Independent audits and reviews

Two recent independent audits/reviews have been carried out – by AMEC in 2011 and by Golder in January 2014.

Both reviews highlighted a number of potential issues with the Resource Modelling process. Many of the issues are currently in the process of being addressed; however, the current Resource does not incorporate the outcomes of this process and the majority of comments still apply to the current Resource.

The following significant issues related to the Resource were highlighted by the AMEC audit:

- Sampling and assay quality control/quality assurance (QA/QC)
- Use of structural and open-pit data in rock set modelling
- Material misclassification in the rock set model
- Blasthole validation
- Cut-off grade (COG) estimation
- Confidence in the grade and tonnage of stockpile.

The following significant issues related to the Resource were highlighted by the Golder review:

- Geochemistry other than simply Ni grades should be used to assist with rock set wireframing
- In pit mapping, resource and grade control modelling should include all major structures
- An alternative unfolding approach should be considered in areas where vertical continuity is expected
- Resource estimation parameters for rock set 5 should be modified
- Resource classification in rock set 5 and in areas of significant structural uncertainty should be revised
- Accurate stockpile densities should be established.

4.1.11 Historical Mineral Resource Statements

Table 4-3 to Table 4-5 presents the Mineral Resource statements for the previous three years.

Table 4-3: Remaining Resources at 30 June 2013 inside Maximum Pit Shell (COG 0.6% Ni), including stockpiles and Slag Stockpile, based on E-Model 2011

Classification	Type	Ore (Mdt)	Ni (%)	Fe (%)	MgO (%)	SiO ₂ (%)	Al ₂ O ₃ (%)
Measured Resource	Laterite	49	1.22	11.7	21.7	43.0	2.25
	Stockpiles	48	1.16	17.7	19.3	36.9	2.77
Indicted Resource	Laterite	186	0.88	18.8	9.44	36.4	4.37
Inferred Resource	Laterite	90	0.76	19.1	8.68	36.8	5.27
Total		373	0.93	17.8	12.1	37.4	4.11
MNR Ore Measured Resource (1)		18	0.23	-	-	-	-

(1) Slag Stockpile in Metal Nickel Recovery Process (COG 0.12% Ni)

Table 4-4: Remaining Resources at 30 June 2012 inside Maximum Pit Shell (COG 0.6% Ni), including stockpiles and Slag Stockpile, based on E-Model 2010

Classification	Type	Ore (Mdt)	Ni (%)	Fe (%)	MgO (%)	SiO ₂ (%)	Al ₂ O ₃ (%)
Measured Resource	Laterite	51	1.28	11.3	21.9	42.6	2.07
	Stockpiles	43	1.22	19.6	17.4	35.6	3.08
Indicted Resource	Laterite	150	0.91	18.2	9.89	36.3	4.24
Inferred Resource	Laterite	119	0.78	19.6	8.10	36.7	5.27
Total		362	0.96	17.9	11.9	37.2	4.14
MNR Ore Measured Resource (1)		19	0.23	-	-	-	-

(1) Slag Stockpile in Metal Nickel Recovery Process (COG 0.12% Ni)

Table 4-5: Remaining Resources at 30 June 2011 inside Maximum Pit Shell (COG 0.6% Ni), including stockpiles and Slag Stockpile, based on E-Model 2009

Classification	Type	Ore (Mdt)	Ni (%)	Fe (%)	MgO (%)	SiO ₂ (%)	Al ₂ O ₃ (%)
Measured Resource	Laterite	52	1.27	10.7	24.1	43.1	1.7
	Stockpiles	39	1.26	20.9	16.4	34.6	3.3
Indicted Resource	Laterite	122	0.96	17.5	11.6	36.9	3.7
Inferred Resource	Laterite	98	0.77	19.1	8.5	36.6	4.9
Total		310	0.99	17.3	13.3	37.5	3.7
MNR Ore Measured Resource (1)		20	0.23	-	-	-	-

(1) Slag Stockpile in Metal Nickel Recovery Process (COG 0.12% Ni)

4.1.12 Summary comments

SRK considers that there are no material flaws in the Resource estimation process, but SRK would add the following qualifications.

Effective date

Although the effective date of the current Public Mineral Resource is 30 June 2014, the cut-off date used for drilling data for this resource model is 30 December 2011. The reason for the lag is partly to do with BHP Billiton/CMSA internal protocols and partly to do with inconsistent reconciliation issues experienced during 2012 and 2013 (see Section 4.2.5 for more detail).

Between 30 December 2011 and 30 July 2014, approximately 2,600 additional holes (Figure 4-2) and in excess of 50,000 assays have been completed within the Resource area. This amounts to approximately 30% more data compared to the December 2011 database. The majority of these new holes have targeted the deeper structurally controlled mineralisation within the existing pit

areas, although there is also a significant amount of drilling outside the existing pit areas as well.

The new drilling is primarily infill drilling aimed at better definition of the location and depth of the existing resource. The impact of the additional information on future resources is that it is unlikely to significantly change the global resource tonnage and grade, but will change the local block by block estimates and is likely to change the tonnages and grades above higher Ni cut-offs. The new drilling will also result in an increase in the proportion of Measured material of future resource estimates.

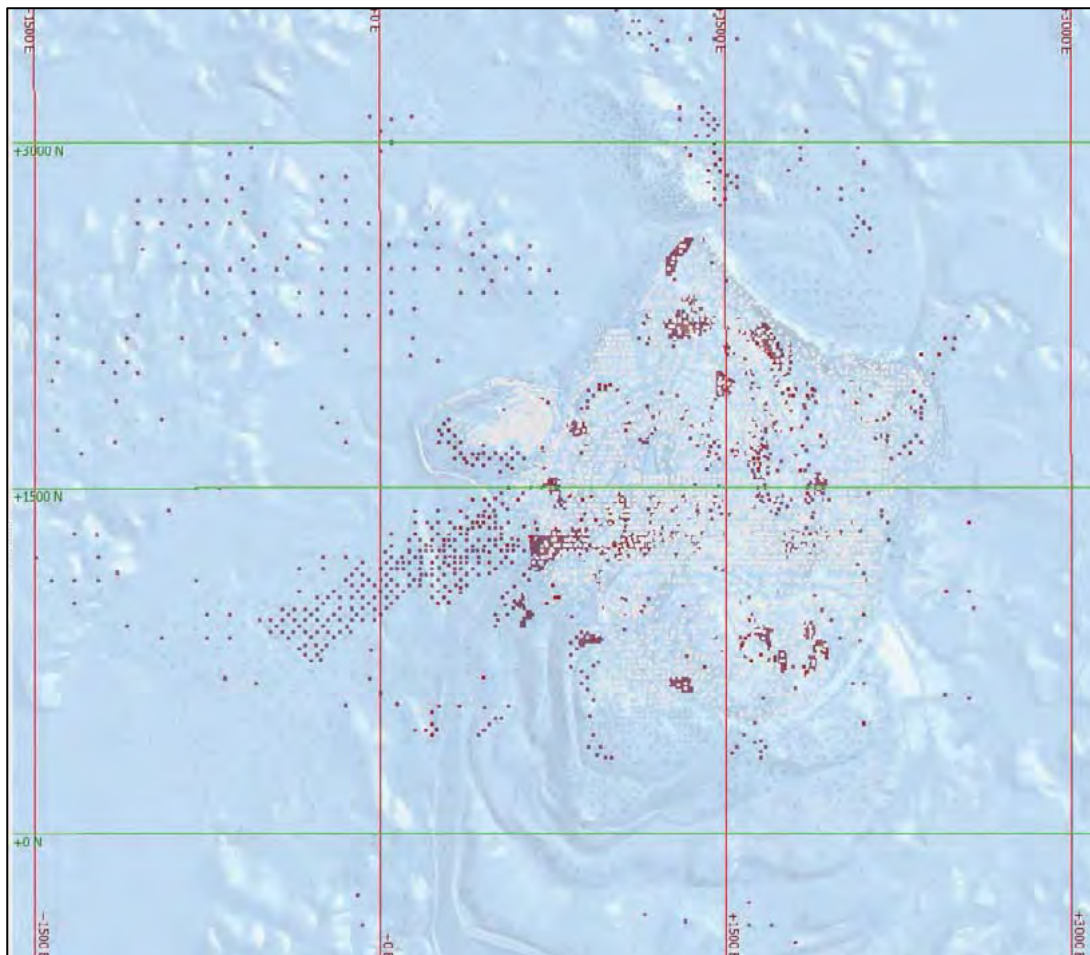

Figure 4-2: Post-December 2011 drilling (in red)

Source: CMSA (2014)

Basement structures

Cerro Matoso is currently in a transition phase with regard to the way in which the resources are modelled and estimated. The current public resource uses a “layer cake” approach in conjunction with the flattening process for modelling and estimation. New models that are in preparation for the next resource update utilise an approach that is designed to take specific account of the structural controls that dominate the deeper mineralisation in rock sets 5 and 6. This, in conjunction with the recent drilling, should provide a more accurate local estimate around the sub-vertical to shallow dipping structures. The previous layer cake methodology required compromises on rock type modelling in areas where structural controls were dominant, resulting in localised smearing and dilution of high grades in the structures.

Drilling since 2012 is targeting the structures and close spaced drilling is being carried out in some areas to define the exact width and depth of structures carrying grade. The current stage of modelling that does not specifically take these structures into account represents both a risk and an

opportunity. The risk is that mine planning, both medium and long term, may be incorrect because the nature of the orebody around the structures may not be as predicted and that the target element, oxide and ratio specifications may not be met. The opportunity is that significantly more Reserves may be defined to extend the mine life. Although stripping ratios will need to increase to mine down into the structures, some of the structures contain continuous mineralisation up to 100 m below the current pit floor. Figure 4-3 shows the June 2013 pit floor, the Ni grade contours, the current drilling and the interpreted structures (the Ni contours and interpreted structures were created by SRK from the CMSA-supplied drilling database).

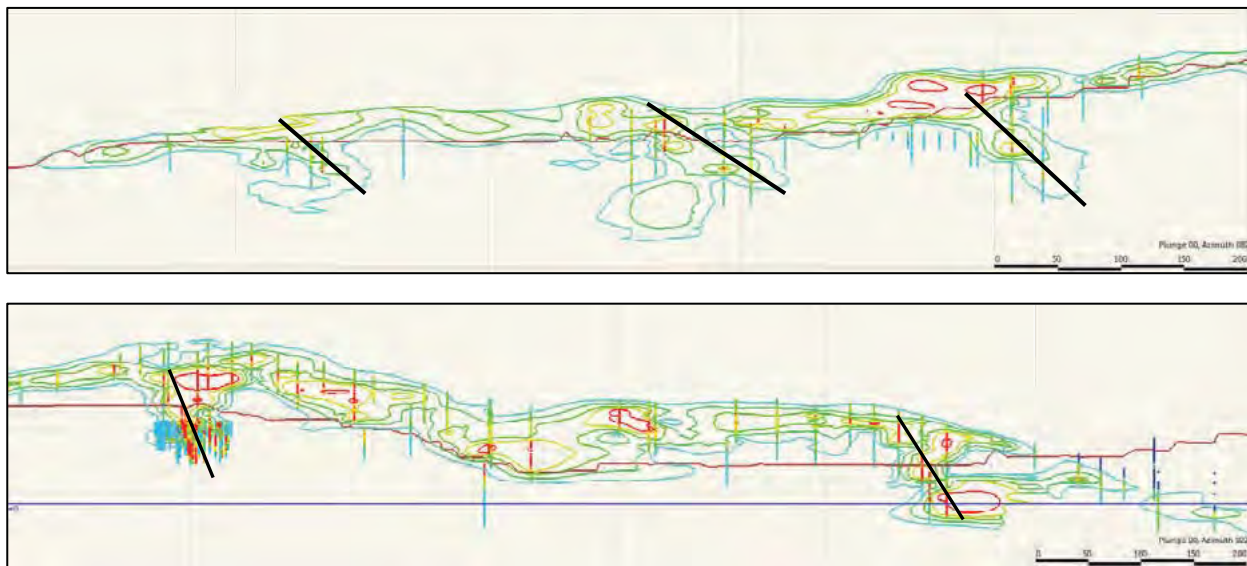

Figure 4-3: Example cross sections of deep structures carrying grade

Reasonable prospects of eventual economic extraction

At the date of SRK's site visit, the heap leach process is not approved for execution. This calls into question the rationale provided by CMSA for "reasonable prospects of eventual economic extraction" given that there is a substantial proportion of the resource that falls outside the criteria for the pyrometallurgical process, specifically SiO₂: MgO ratios that are above 1.84 (the current average Resource SiO₂: MgO ratio sits at 3.0). This material cannot be processed by the pyrometallurgical process in its current configuration. CMSA has identified a number of "opportunities" defined in the FY16 Opportunity Assessment Scope document.

These deal with the following three potential projects aimed at enabling the pyrometallurgical process to accommodate higher SiO₂: MgO ratios:

- 1 Stockpile Chemistry Optimisation Project (SCOP) aimed at enabling SiO₂: MgO ratios <2.0 (in slag)
- 2 High SiO₂: MgO ore feed project aimed at processing material >2.8 SiO₂: MgO by reconfiguring the furnace chemistry and temperatures
- 3 Upgrading 2 Project which aims to upgrade the ore prior to feeding it to the pyrometallurgical process, increasing the Ni grade and altering the SiO₂: MgO ratio with an associated loss of feed tonnage.

There is also potential to blend high SiO₂: MgO material that has been identified by CMSA's brownfields exploration program, but which is not yet at resource stage. There are two areas of interest – Planeta Rica, 40 km to the north and Uré some 15 km to the south.

In the absence of an approved heap leach process at this point in time, justification of "reasonable

prospects of eventual economic extraction” of the portion of the current resource with high SiO₂: MgO depends on the successful implementation of some or all of these projects and/or blending with material using the current exploration targets. CMSA are of the opinion that some form of heap leach process may still be viable in the future with changes to the configuration and/or higher nickel prices.

Stockpile Resource classification

Given the age of some of the stockpiles and the historical reconciliation issues, there are some concerns that the grades and tonnage estimates may not be accurate. SRK’s examination of the Resource block model shows that while some stockpiles have varying grades consistent with a detailed model estimate, others have a single average grade assigned to them. The Measured classification of these stockpiles is questionable. SRK notes that stockpile drilling is in progress and that all stockpiles are currently being, or are planned to be, drilled and assayed to improve confidence in the grades on a selective mining unit (SMU) scale.

4.2 Ore Reserve estimation and classification

The 2014 Reserve is derived from the 2014 Mineral Resource which is based on the 2011 resource model and does not account for drilling post December 2011 (Section 4.1.3).

The June 2014 Ore Reserve statement is based on material from within the ultimate pit design and from existing stockpiles (including the rejected material from the upgrading process), which is capable of meeting operational targets over time. The Reserve estimation takes into account the Measured and Indicated Resources. The Inferred Resource in the schedule is categorised as waste.

The Reserve estimation process is made up of three stages. The first takes the Resource model and through application of modifying factors such as selectivity, operational dilution and mining losses, attempts to simulate the mining process. This outcome is reflected in the recoverable Reserves model. Through the application of mining optimisation, the second stage is definition of the portion of the ore deposit and stockpiles that is economically minable. The third stage takes the material within the ultimate pit and stockpiles, and generates a mining plan using phase designs and current and future operational targets. Based on this, the mine plan predicts the potential cash flow over the life of mine (LOM). The Ore Reserves Statement represents the scheduled material with positive cash flow.

4.2.1 Stage 1 – Modifying factors

The Reserves Model is the outcome of the process of converting Resources into “Recoverable Reserves”. The method consists of applying a series of modifying factors in order to adjust the estimation with local variability and mining method, which will be used on each *in situ* block of material.

A systematic adjustment process was undertaken where three kinds of factors are applied – skin dilution (already applied during regularisation of combined Resource Model as dilution ore intermixing along the contacts), mining recoveries (change of support) and mining factors (reconciliations with production and dilution) as shown in Figure 4-4.

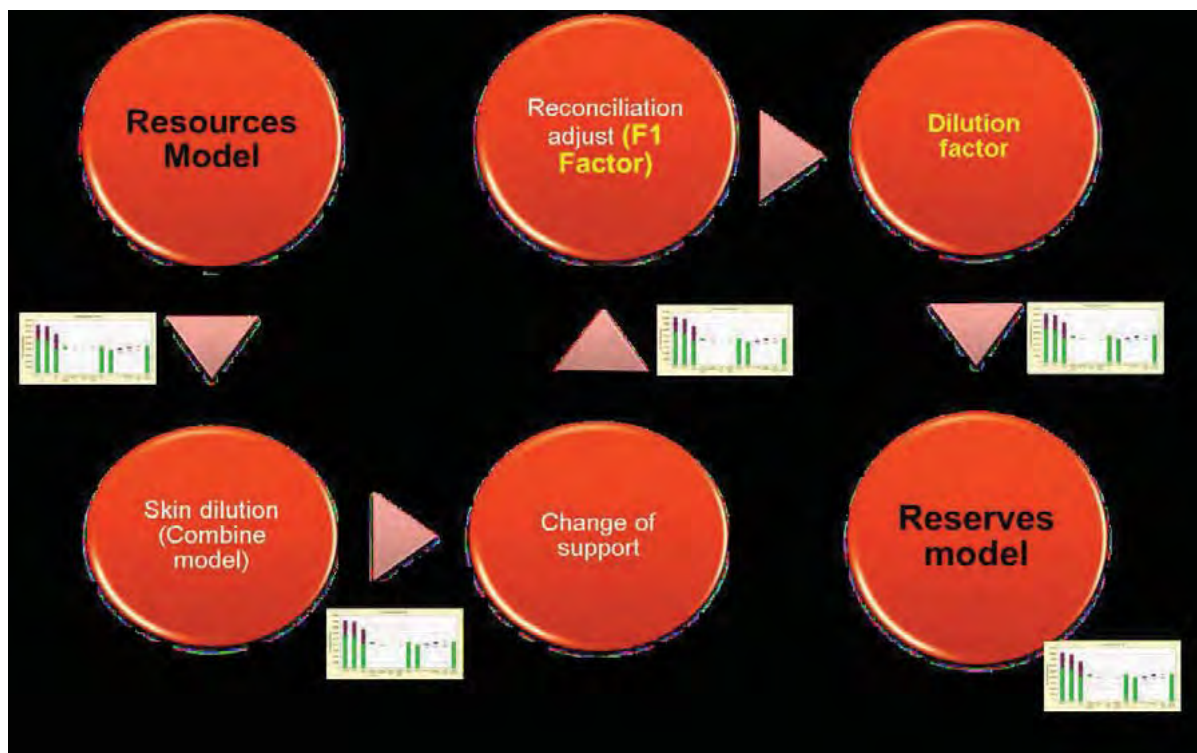

Figure 4-4: Resource to Recoverable Reserve model process

Source: CMSA (2014)

Skin dilution

The Resources Model was initially adjusted by combining the rock set models and applying a regularisation of the blocks from an initial minimum sub-cell size of 4.17 x 4.17 x 0.01 m to a regular size 12.5 x 12.5 x 7 m for all cells. The effect of regularisation of the blocks is dilution and mixing of rock types along the contacts.

Within the mineralised zone, this makes little difference to the overall grade and tonnage; however, the blocks which share limits with non-mineralised zones drops the Ni grade estimated generating the “skin dilution” effect. This occurs along the top contact (e.g. sedimentary overburden) as well as along the bottom contact (e.g. Fresh rock).

Affine correction

The second adjustment factor is the change of support process known as an affine correction. The theory behind the application of this correction is the fact that blocks estimated by ordinary kriging smooth the block distribution to some extent depending on the level of drilling information available. This smoothing is necessary for the best local block by block estimation, but is done at the expense of altering the tonnage and grade above higher cut-offs compared to real block variability. The application on an affine correction consists of transforming a block grade distribution by either “squeezing” or “stretching”, whilst maintaining a constant mean grade value in an attempt to reproduce block grade variability similar to real block grade variability.

Reconciliation factor

The reconciliation factor is based on mined areas (evaluated with an adjusted model with both skin dilution and affine correction) over the last three years against the production data. This adjustment objective is to align the predicted reserves with the real production. Tonnes and grades of the Reserves model adjusted with skin and affine correction are compared against the grade control model in order to align it; this factor is applied globally in all blocks above 1.0% Ni.

Dilution factor

The grade control evaluation in turn is evaluated against the actual production in order to calculate the Reconciliation Factor, F2. The theoretical dilution factor is calculated based on production area evaluation using SMUs simulating different buckets sizes (for example, CAT 777= 4 x 4 x 3.5 m) in order to calculate the potential dilution of the mining fleet. The F2 and dilution factor are applied together on blocks >1.0% Ni with waste face contacts (material <1.0% Ni).

4.2.2 Stage 2 – Pit optimisation

Cut-off parameters

Traditional cut-off approaches are based on Ni grade, which is used to decide whether material is sent to processing plant or waste dump. However, in the case of industrial minerals like nickel, the ore sent to processing also depends on other elemental grade qualities related to the extraction process and to the final product specifications required for sale.

Optimisation

The scope of this stage is to identify all resources that should be mined in order to maximise the net present value (NPV) of the asset. The Recoverable Reserves model (resources model with modifying mining factors applied) is used as input. The blocks were aggregated using a clump and cluster methodology (*Blasor* RDP methodology), taking into account an outline defined by a series of nested shells generated by the Lerchs-Grossman algorithm. These were sequenced to adhere to geotechnical and mining constraints and seek to generate a schedule with maximised NPV. CMSA have used BHP Billiton internal long term commodity price protocols (mid case) for the optimisation.

4.2.3 Stage 3 – Design and scheduling

This stage considers material from within the optimised pit shell and the stockpile model together with practical pit design constraints (Section 7.2.2).

The Indicated and Measured resources contained within the final pit design (which also contains the stockpile inventory) are the mineral inputs for the production schedule. The production schedule is carried out using BHP Billiton's proprietary *Blasor* 10 software (*Blasor*). The ore presented from within the pit design is scheduled according to predetermined metallurgical, economical and mining constraints. *Blasor* utilises material that has a Ni grade below the breakeven cut-off if other elements of that material have a favourable impact on the blended feed to the crusher. As such, the Ni cut-off grade is variable – dependent on the blending requirements of the period being scheduled. While working within the above constraints, *Blasor* primarily targets a NPV maximised scheduling solution.

The scheduling periods used in *Blasor* were quarterly for the first five years, and annually for the remaining LOM.

In addition to the constraints listed in Table 4-8, the following constraints were also applied:

- Plant throughput/crusher feed at an annual maximum throughput of 3.1 Mtpa
- Ni metal produced not to exceed a maximum output of 55.0 kilotonnes per annum (ktpa)
- Plant will operate in Low SiO₂: MgO ratio.

The Reserve is developed from the production schedule and a full financial assessment of this production schedule to verify a positive cash flow.

4.2.4 Ore Reserve statement

The JORC Code defines Ore Reserves as the economically mineable part of a Measured and/or Indicated Mineral Resource. It includes diluting materials and allowances for losses, which may occur when the material is mined. Appropriate assessments and studies have been carried out, and include consideration of and modification by realistically assumed mining, metallurgical, economic, marketing, legal, environmental, social and governmental factors. These assessments demonstrate at the time of reporting that extraction could reasonably be justified. Ore Reserves are sub-divided in order of increasing confidence into Probable Ore Reserves and Proved Ore Reserves.

The CMSA June 2014 Ore Reserve estimate is based on the LOMP for FY14 and is effective as at 30 June 2014. The Reserve estimate was 48.5 Mt (49 Mt rounded) at 1.2% Ni, reflecting a 0.7% Ni cut-off (Table 4-6). The Ore Reserve is classified as Proved and Probable, in compliance with the 2012 JORC Code.

The Ore Reserves estimate includes 24 Mt *in situ* (laterite) containing 1.1% Ni grade and 24 Mt of stockpiles containing 1.3% Ni grade. Compared to the June 2013 Reserve estimate, material from the slag stockpile (MNR process) is not included in the June 2014 Reserves, as the process is currently being re-evaluated, with the closure of MNR facilities a possible outcome. Esmeralda has also been removed from the June 2014 Reserves.

As a confirmation on the stated June 2014 Reserve, SRK has taken the supplied Reserve block model (resmodj3014.dm), applied the 30 June 2014 surface digital terrain model (DTM) of the pit and dump face positions and then reported all material (classified as "RESER" equal to value 1 or 2 below this June 2014 surface). The "Reserve" reported by SRK is 46.1 Mt grading 1.21% Ni. This is compared to 48.5 Mt (49 Mt rounded), grading 1.21% Ni, presented in the LOM production schedule. The variance of 2.4 Mt is likely due to the CMSA June 2014 Reserve being produced by a depletion exercise based on the June 2013 Reserve. This approximates to a 5% tonnage variance, which is within the 10% Reconciliation Metric variance deemed the limit, for BHP Billiton processes. This tonnage variance represents approximately nine months' production if removed from the LOM production schedule. SRK has also analysed this variance in terms of valuation and finds that the resulting NPV variance is not material.

Table 4-6: Ore Reserve Estimate, 30 June 2014

Classification	Type	Ore (Mdt)	Ni%	Fe%	MgO%	SiO ₂ %	Al ₂ O ₃ %
Proved Reserves	Laterite	16	1.2	9.3	25.6	44.0	1.4
	Stockpiles	24	1.3	19.3	17.4	36.4	3.0
Probable Reserves	Laterite	7.7	1.0	10.4	25.8	42.5	1.6
Total Reserves		49	1.2	14.5	21.5	39.9	2.3

Note: Based on a 0.7% Ni cut-off grade. Variance in total is due to rounding.

Source: CMSA (2014)

The reduction in the June 2014 Reserves from the June 2013 Reserve statement is due to:

- 1 Exclusion of Esmeralda Reserves due to delays to source the Social and Environmental license
- 2 Lower Ni price used for optimisation process (from US\$9.88 to US\$9.30)
- 3 Changes in Resources model adjustment factors
- 4 Changes in Fe grade specification required by the process from [11%-16%] range to [11%-15%] range
- 5 Geotechnical instability in Pit 6 caused sterilisation of some mineral blocks (118 kilotonnes (kt) ore @ 2.43% Ni)
- 6 MNR (slag regrind) due to a reassessment of project economics.

Esmeralda Deposit

The Cerro Matoso Mine Expansion Project (MEP) will extend the mining footprint to the Esmeralda orebody, which is continuous mineralisation adjacent to the existing Main Pit, but separated by the Uré River.

CMSA has included Esmeralda ore as part of the Mineral Resources and Ore Reserves statement since 2001. However, for the June 2014 reporting, the Esmeralda orebody has been excluded from the Ore Reserves Statement pending receipt of a Social and Environmental licence for the Esmeralda area.

For Esmeralda area, CMSA developed a full Environmental and Social Impact Assessment (ESIA), and in March 2011, requested a modification of its environmental license to include mining operations in this new area. However, due to the terms and conditions established in the Amendment to contract 051-96M, negotiated with Colombian mining authority to extend the current mining concession, the Colombian environmental authority has informed CMSA that a new Social and Environmental License will be required to start mining activities in the Esmeralda area. As a result, a new ESIA approval process will be initiated, and CMSA expects to obtain approval by July 2016.

Based on the above, Esmeralda has been excluded as part of the CMSA Reserves declaration, removing Esmeralda from Securities Exchange Commission (SEC) declaration and JORC/ASX declaration dated June 2014.

The Amendment contemplates the need for an Environmental License for any new developments that are outside the original permitted areas (866 and 1727 Concession Areas).

4.2.5 Historical Ore Reserve Statements

Table 4-7 to Table 4-9 presents the Ore Reserve statements for the previous three years.

Table 4-7: Statement of Ore Reserve Estimate, E-Model 2011, June 2013, (0.8% Ni cut-off)

Classification	Type	Ore (Mdt)	Ni (%)	Fe (%)	MgO (%)	SiO ₂ (%)	Al ₂ O ₃ (%)
Proved Reserves	Laterite	25.3	1.40	10.0	24.5	43.5	1.59
	Stockpiles	40.4	1.18	18.2	18.9	36.5	2.89
Probable Reserves	Laterite	17.8	0.97	12.0	23.5	41.9	2.12
Total Reserves		83.5	1.20	14.4	21.6	39.8	2.33
MNR Ore (1)		17.5	0.23				

(1) Slag Stockpile in Metal Nickel Recovery Process, COG=0.12

Table 4-8: Statement of Ore Reserve Estimate, E-Model 2010, June 2012, (0.8% Ni cut-off)

Classification	Type	Ore (Mdt)	Ni (%)	Fe (%)	MgO (%)	SiO ₂ (%)	Al ₂ O ₃ (%)
Proved Reserves	Laterite	41.0	1.30	10.2	25.2	42.8	1.60
	Stockpiles	34.0	1.21	20.1	16.9	35.3	3.31
Probable Reserves	Laterite	16.0	1.01	11.6	23.0	42.4	2.32
Total Laterite		91.0	1.21	14.2	21.7	39.9	2.37
MNR Ore (1)		19.0	0.23				

(1) Slag Stockpile in Metal Nickel Recovery Process, COG=0.12

Table 4-9: Statement of Ore Reserve Estimate, E-Model 2009, June 2011, (0.8% Ni cut-off)

Classification	Type	Ore (Mdt)	Ni (%)	Fe (%)	MgO (%)	SiO ₂ (%)	Al ₂ O ₃ (%)
Proved Reserves	Laterite	33.0	1.43	10.4	24.9	42.7	1.60
	Stockpiles	38.0	1.26	20.7	16.6	34.7	3.20
	Rejects	7.0	1.00	7.0	30.0	44.2	0.90
	MNR Ore ⁽¹⁾	20.0	0.23				
Probable Reserves	Laterite	15.0	1.15	11.3	23.4	42.2	2.1

(1) Slag Stockpile in Metal Nickel Recovery Process

4.2.6 Historical reconciliation

Reconciliations were performed and reported in accordance with BHP Billiton Tenement Management, Exploration Results, Resource and Reserve Reporting procedures, which resulted in the derivation of the following reconciliation factors:

- F1: Grade Control to Ore Reserve Model (b/a)
- F2: Actual Process Plant feed to Grade Control predicted feed (c/b)
- F3: Final product inventory to Ore Reserves predicted (d/a).

Where:

- a: resource and reserves model depletion (based on pit surveys)
- b: grade control model depletion (based on pit surveys)
- c: plant feed (based on pit survey and stockpile changes)
- d: shipment (based on ship loader weights and sampling).

Reconciliation over the past three years is a complex process and there are many factors involved. It can be seen from the charts in Figure 4-5, Figure 4-6 and Figure 4-7 that there are still a number of unresolved issues with the reconciliation process. A review by Golder in January 2014 examined many of the potential causes of the historically poor reconciliation and proposed numerous actions. Some of these actions are currently in the process of being implemented.

The Golder recommendations were as follows:

- Geochemistry other than simply Ni grades should be used to assist with Rock set wireframing.
- In pit mapping, resource and grade control modelling should include all major structures.
- Estimation parameters for grade control modelling should be modified.
- An alternative unfolding approach should be considered in areas where vertical continuity is expected.
- Resource estimation parameters for Rock set 5 should be modified.
- Resource classification in Rock set 5 and in areas of significant structural uncertainty should be revised.
- The affine correction factor for Rock set 5 should be adjusted if F1 and F3 fall significantly below 100%.
- The “F1” and “F2” support adjustments should be discontinued. If used, the “F1” and “F2” correction factors should consider mining/equipment constraints to the grade control model.
- Wireframes/polygons for ore and low grade stockpile material should be kept for reconciliation.
- Blast movement, especially for free-face blasts, should be measured and accounted for during

mining.

- Flags at the vertices of the planned mining polygons should attempt to account for blast movement.
- Accurate stockpile densities should be established.
- When reconciliation problems arise, F1 and F2 factors should be calculated by Rock set/Area.
- Reconciliation procedures should be documented and annual models/macros, and output files archived.
- Long-term mine planning work should be delayed until recommendations have been implemented.

SRK is in general agreement with these recommendations, with the following exceptions:

- The use of the affine correction is in SRK’s opinion just another adjustment factor. The use of it is not well justified or well implemented and adds confusion to the Resource to Reserve and reconciliation processes.
- SRK has not examined the reconciliation process in sufficient detail to comment on the comments that relate to the estimation parameters for Rock set 5.

In addition, SRK notes that the majority of mining is now taking place in areas where sub vertical structural controls dominate the rock set composition, and hence the resulting ore chemistry. These sub vertical rock set controls are not specifically accounted for in the resource model and may form a significant portion of the recent F1 and F3 differences.

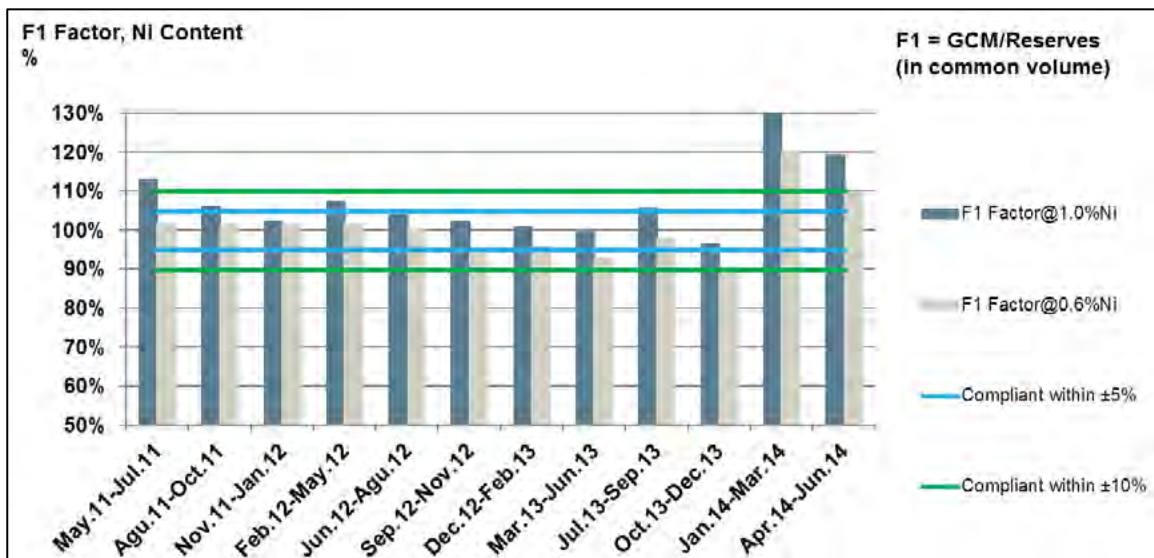

Figure 4-5: F1 reconciliation factors May 2011 to June 2014

Source: CMSA (2014)

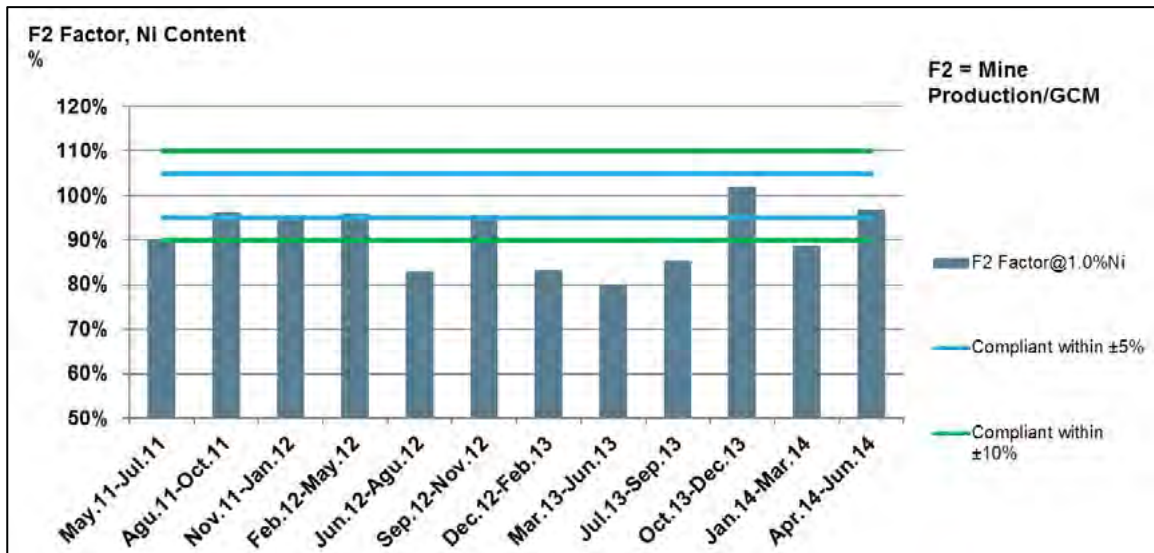

Figure 4-6: F1 reconciliation factors May 2011 to June 2014

Source: CMSA (2014)

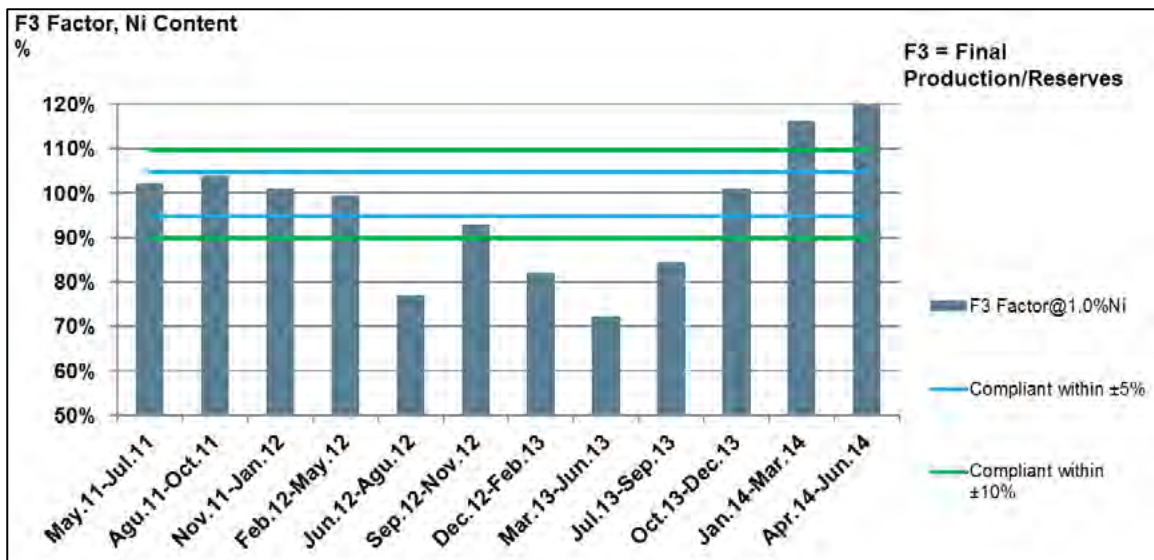

Figure 4-7: F3 reconciliation factors May 2011 to June 2014

Source: CMSA (2014)

4.2.7 Ore Reserve (SRK Depleted) - 31 December 2014

The Ore Reserve (SRK Depleted) (Table 4-10) is based on the CMSA 30 June 2014 Reserve and depleted utilising production records and the forecast crusher feed to 31 December 2014.

SRK has taken the CMSA 30 June 2014 Reserve and depleted based on the actual crusher feed reported by CMSA (July 2014 to October 2014 inclusive) and the 5 Year forecast for November and December 2014. The results of this depletion process is presented in Table 4-10, resulting in a Ore Reserve (SRK Depleted) – 31 December 2014 of 47Mt at 1.19% Ni crusher feed grade. CMSA have also provided a depletion to the end of December 2014 matching this Reserve within acceptable rounding errors.

Table 4-10: Ore Reserve (SRK Depleted) - 31 December 2014

	Ore (Mdt)	Ni%	Source
Reserve as at 30 June 2014*	48.5	1.2	CMSA CP Report 2014
Depletion July 2014 to Oct 2014 (actuals)	0.95	1.62	Monthly reports
Forecast Nov 2014	0.26	1.64	5YP_Plan quinquenal FY15toFY19RTV4.0_20140327
Forecast Dec 2014	0.27	1.64	5YP_Plan quinquenal FY15toFY19RTV4.0_20140327
Calculated Reserve Estimate as at 31 Dec 2014	47.0	1.19	

* 48.5 was used in other Reserve tables where first decimal place was given.

The Reserve estimate based on LOMP FY14 and forecasted as at 30 June 2014 was 48.5 Mt at 1.2% Ni, above 0.7% Ni cut-off. The Ore Reserve is classified as Proved and Probable, in compliance with the 2012 JORC Code.

Note:

This report includes information on Ore Reserves as reported by F Fuentes (MAusIMM). The information is extracted from the report titled BHP Billiton 2014 Annual Report and is available to view on www.BHPBilliton.com.

All Competent Persons are full-time employees of BHP Billiton at the time of reporting and have the required qualifications and experience to qualify as Competent Persons for Ore Reserves under the 2012 Edition of the "Australasian Code for Reporting of Exploration Results, Mineral Resources and Ore Reserves" (JORC Code). The Competent Persons verify that the report is based on and fairly reflects the Ore Reserves information in the supporting documentation and agree with the form and context of the information presented.

BHP Billiton confirms that it is not aware of any new information or data that materially affects the information included in the original market announcements and, in the case of estimates of Ore Reserves that all material assumptions and technical parameters underpinning the estimates in the relevant market announcements continue to apply and have not materially changed. BHP Billiton confirms that the form and context in which the Competent Persons' findings are presented have not been materially modified from the original market announcements.

The Ore Reserves breakdown by classification (100% basis) is contained in Table 4-6. All tonnes and quality information has been rounded, hence small differences may be present in the totals.

4.2.8 Summary comments

Recoverable Resources

The use of an affine correction applied post-Resource as a modifying factor in the Resource to the Reserves process is unusual. If the drilling density and block size used create smoothing of the block estimate sufficient to make the resulting grade and tonnage curves significantly different to the grade and tonnage curves that result from grade control models used during production, then this should be addressed at the Resource estimation stage. However, grade and tonnage curves before and after the affine correction, show almost no difference and the need for the affine correction at all is questionable. If studies show that smoothing and large Resource blocks are an issue, then other methods of estimating Recoverable Resources at an SMU block size are available. These should be applied as part of the Resource estimation rather than as a modifying factor in the Resource to Reserve conversion process.

Ore Reserves

The CMSA Ore Reserve - 30 June 2014 has been accepted by SRK. Using this reserve as a basis for the depletion exercise, SRK estimates the remaining Ore Reserves as of 31 December 2014 as 47Mt grading 1.19% Ni (as per Table 4-10).

It is noted that in the LOM production schedule there is a significant reliance on stockpile feed to the primary crusher. In SRK's opinion, the density of the stockpiles is not entirely reliable. This is not a unique problem for CMSA, however due to CMSA's reliance on these stockpiles and a change in stockpile density over time due to compaction, the tonnes reported by actual production records and tonnes reported below an "end of period surface" against the block model can be significantly different. As stated previously, SRK notes that stockpile drilling is in progress and that all stockpiles are currently being, or are planned to be, drilled and assayed to improve confidence in the grades on a selective mining unit (SMU) scale.

Reconciliation

Although the historical reconciliation is poor, there is no clear evidence regarding at which stage(s) of the resource, reserve, grade control, mining or processing chain the major errors are occurring. The F3 reconciliation factor (Production/Reserves) for Ni metal has gone from neutral to negative and back to positive in the past three years, no consistent trend is evident. Changes in the modelling and adjustment methodology at all stages of the chain have occurred over this period, further adding to the difficulty of identifying the underlying causes.

The mining of the orebody is now at a stage where the rock types and geometry of the mineralisation are considerably different to the historical conditions of the past 25 years. The proportion of process feed that is sourced from stockpiles is also much greater than in previous years. Both factors contribute to the reconciliation issues observed.

5 Geotechnical Engineering

5.1 Introduction

There have been comprehensive geotechnical design studies and hydrogeology studies carried out for CMSA. Available information includes successive geotechnical design reports and memorandums, plans for ground control management and geotechnical processes, drilling design plans, and documentation concerning slope stabilisation measures.

5.2 Geological conditions

The major rock types on site consist of peridotite bedrock overlain by a residual horizon of saprolitic/lateritic materials. In the North Wall of the Main Pit (Pit 6 area) and in the Esmeralda Pit, the Cerrito Formation sedimentary sequence of sandstones, siltstones and mudstones/ claystones overlies these igneous materials, along a principal contact/weathering zone. In places, this zone is thought to be a faulted contact. Alluvial materials overlie all other materials at surface, except at the crest of the hill that has formed the central focus of the Main Pit.

Two principal sub-vertical fault systems have been reported, trending approximately N–S and NW–SE. These systems are in places evident in pit walls as zones of highly fractured rock.

5.3 Groundwater

The conceptual hydrogeological and 3D groundwater flow models were updated by SRK in 2011 (SRK, 2011). These indicate the following:

- Overlying alluvium is of low permeability.
- There is low “vertical” permeability across unit boundaries.
- Permeability of the Cerrito formation sediments are moderate to low (generally low in the Esmeralda area) and these are in poor connection with the groundwater surface systems due to the low vertical permeability.
- Saprolitic materials and the peridotite are of low and very low permeability respectively.
- Maximum inflow to the Main Pit will increase over time as mining progresses.
- A cone of drawdown as a result of in-pit dewatering of the Esmeralda Pit will propagate to a maximum radius of ~1 km from the ultimate pit by the end of excavation.
- Due to the overall system being dominated by low permeability materials restricting connectivity, it is expected that active dewatering systems (drainholes, wells etc.) would in general not be very effective in lowering groundwater levels.

From the site visit, it is understood that in pit dewatering drains are currently being employed as an active dewatering measure for the remaining cutbacks in the Main Pit and in other wall areas only where water seepage and likely concentration behind the pit face is evident.

5.4 Rockmass conditions

The peridotite is described from the design reports and from the site visit as being generally poor to moderate in quality, moderately to highly fractured with low intact rock strength. The saprolite generally represents very weak material.

The Cerrito Formation sedimentary units present moderately to well indurated materials of generally low strength (locally poorer, depending on the sequence unit), whilst the “soil” (alluvial) materials are very weak, as expected.

Where fault or shear zones have been encountered in the pits or within drillholes, these present highly fractured, very poor quality rock.

The characterisation of these materials in the report, “*Actualización Modelo Geotécnico, Cerro Matoso S.A.*”, November 2012, has been done in a manner which is unusual in that the rockmass strength of the rock-like materials of the Cerrito Formation has been characterised using a shear strength model (Mohr-Coulomb) that would be more appropriate for weaker, soil-like materials and the saprolite materials have been characterised using the Hoek-Brown shear strength model, which is more appropriate for stronger rock-like materials.

5.5 Slope stability

The slope design parameter recommendations have been presented based on stability analyses in the report, “*Actualización Modelo Geotécnico, Cerro Matoso S.A.*”. Comprehensive sets of analyses have been carried out to support slope design recommendations for both the Main Pit and Esmeralda Pit. Although stability analyses have been conducted fairly rigorously, there is doubt as to whether the most likely failure mechanisms have been captured in this process (they may not be circular failures, as indicated in the analyses, and path search failure analyses should have been conducted). The presence of weak materials such as saprolite within the pit wall excavations at considerable distance below the pit crest, and beneath stronger rocks of the Cerrito Formation, could potentially have a marked effect on failure mechanism and paths and it is not clear that this has been adequately taken into account in the design analyses. In light of this, SRK has some concerns regarding the suitability of some of the design parameters, especially in terms of recommended inter-ramp angles (IRAs) which could in places, be too steep.

The slope displacements of three benches and failure of one of these benches in the North Wall of Pit 6 in June 2013 appears to have occurred in a fashion that was not predicted by the analyses, and that was triggered or exacerbated by the exposure in the excavation of mudstones of the Cerrito Formation to water ingress from rainfall and surface drainage – with resultant elevation of pore water pressures. Such water flow into this unit was not previously possible due to the low vertical permeability of the units and therefore their low connectivity to surface water. The mudstones undergo significant strength reduction and swelling when saturated. A large waste rock buttress was utilised to stabilise the slope. The evaluation work subsequently conducted by Knight Piésold in 2014 (detailed in the report, *Cerro Matoso Pit Geotechnical Evaluation, Slope Stabilisation at the North Wall of Pit 6*) has recommended a 2.5H: 1V (22°) overall slope angle for the North Wall within the Cerrito Formation sedimentary units, without benches because bench faces present locally steep slopes that were thought not to be stable under saturated conditions.

Following the Pit 6 North Wall failure, it appears that onsite geotechnical assessments, planning and monitoring has become rigorous and comprehensive, with well-defined processes instituted for ongoing geotechnical model validation and re-evaluation. An internal guidelines document, “02.03.10.03.18.15 *Procesos Geotecnicos_Draft*”, 2013, has been developed to address and follow up the development of geotechnical modelling at CMSA, to ensure optimal and safe extraction of mineral resources and the proper disposal of waste, and describing the scope to manage geotechnical information associated with all the projects where geotechnical input is required. Another document, “*Informe del Sistema de Control del Terreno en Cerro Matoso S.A.*”, by Ausenco in June 2011, outlines a general framework for the ground control management system, as well as assessment, analysis and management of risk.

Two slope stability radar monitoring devices are currently employed in the Main Pit (Pit 6 area), although the movement of long grass on the North Wall does make meaningful interpretation of and reaction to small increments of apparent movement difficult. Another radar system is apparently planned to be employed in the Esmeralda Pit. Geotechnical drillholes are now twinned with

piezometer holes for ongoing monitoring of groundwater levels. There is a permanent site team of two geotechnical engineers and a hydrogeologist to monitor and assess geotechnical stability issues.

At a bench scale, double benches of 14 m height are currently employed in the Main Pit and in general seem to perform reasonably well, with some rilling and erosion – especially of poor quality materials. The materials are in general not of sufficient quality that pre-splitting techniques for blasting excavation are effective.

Currently, surface drainage measures for pit walls consist of drains at the toe of each bench (batter). Whilst this can be an effective measure for surface drainage, observations made during the site visit indicate that in many places, the water is not effectively flowing along and being removed by the drains, but is collecting and ponding in the drains. Where the drains are not concrete-lined, this can lead to concentrated ingress of water close behind the face of the pit slope below – which may have a negative impact on stability.

There appear to be no issues with trafficability along the haul roads and within the pit – there is plenty of peridotite waste material available to provide sheeting.

5.6 Summary comments

- There are some concerns regarding the suitability of some of the design parameters for the pit slopes, especially in terms of recommended IRAs which could in places be too steep. There is risk if material strengths and a re-analysis of the slope design is not carried out in order to ensure that the design recommendations and bench configuration are indeed suitable in light of the failure and resulting investigation for the North Wall of Pit 6.
- Following the Pit 6 North Wall failure, it appears that onsite geotechnical assessments, planning and monitoring has become rigorous and comprehensive, with well-defined processes instituted for ongoing geotechnical model validation and re-evaluation by a permanent site team. These measures are very useful for detection and management of slope instability and control of slope performance.
- It has been observed that water is not effectively flowing along and being removed by the drains at the toe of each bench, but is collecting and ponding in them. This can lead to concentrated ingress of water close behind the face of the pit slope below, which may have a negative impact on stability.

6 Hydrology and Hydrogeology

6.1 Hydrology

6.1.1 Physical setting

The Cerro Matoso mine site is located in a tropical environment with high annual precipitation. The mean annual precipitation is 2,498 mm; mean annual evaporation is 1,204 mm. The distribution of rainfall is divided into a “wet period” (May to October), two “transition periods” (April and November) and a “dry period” (December to March).

The mining area lies within the Uré River catchment, which flows from the south to north, traversing areas of low topography.

6.1.2 Water supply and water balance

Limited information and reporting on the mine site water demand and supply was available. However, it is understood that water supply ponds provide ample storage to meet dry season make-up water requirements for the plant.

6.1.3 Flood management

The Uré River passes within 30 m of the Main Pit located to the west, as depicted in Figure 6-1. Recorded flow rates in the Uré River vary between 22 m³/s and 78 m³/s, with a maximum flow depth of 6 m. Given the flow characteristics of the Uré River and its proximity to the pit, flood mitigation measures are a necessity.

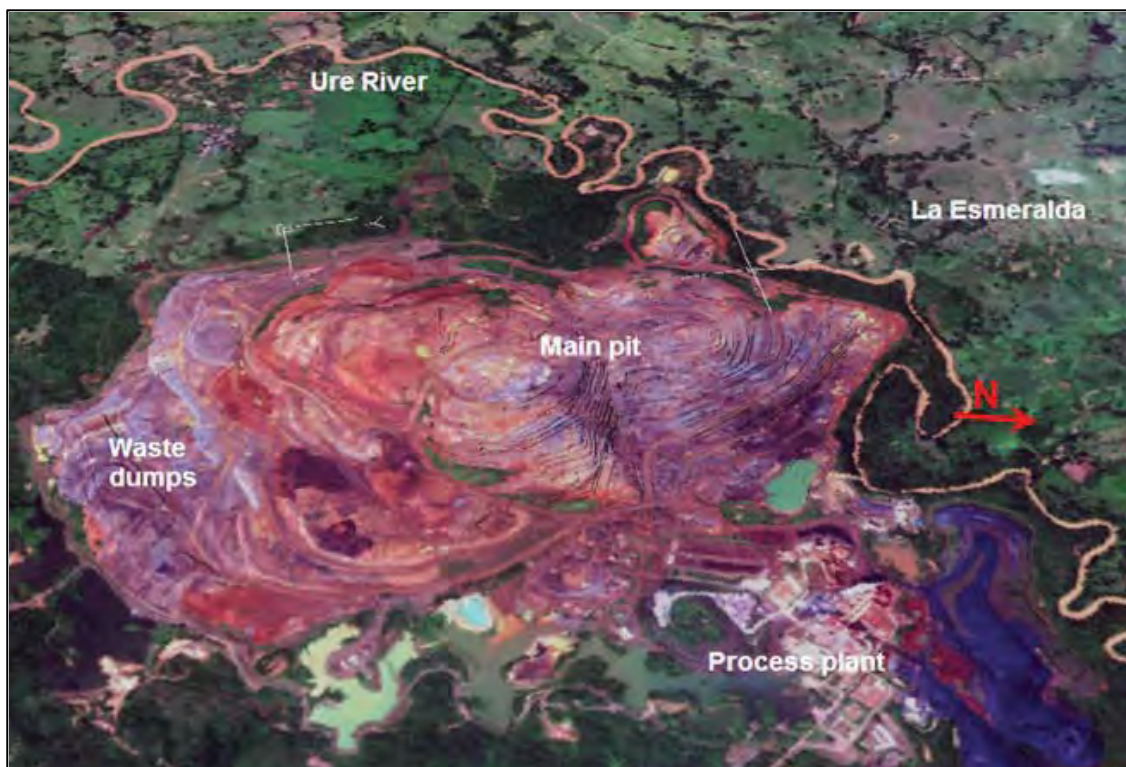

Figure 6-1: Overview of Main Pit and Uré River

Source: CMSA (2014)

The peak flow flood model was updated in 2010 in order to establish the recommended crest elevation for the levees that would be needed to mitigate flooding to the Esmeralda Pit and Main Pit.

Flood model inputs for rainfall take the spatial and temporal distribution of precipitation for various return periods into account. Model calibration of the hydrological and hydraulic parameters was carried out using flow data from a contiguous catchment (San Pedro River), where historical flow data is available. The justification for calibrating flow rates using these datasets is that ostensibly both catchments have similar morphologic characteristics (soil, soil use, geomorphology and shape of the river course).

Peak flow rates and corresponding flow depths for 1:25-, 1:100-, 1:1,000- and 1:10,000-year return periods were calculated using the updated calibrated flood model. Total freeboard values were determined based on hydraulic and geotechnical parameters. Table 6-1 shows water surface levels (flood modelling), required freeboard and recommended levee crest elevations for each return period.

It is noted that mine operations above the Uré River level means that surface water flows out of the pit by gravity. However, as the mine gets deeper, water pumping will be required. At this point in time, surface water control measures will not only influence the design of pumping stations, but also mine operation. Currently, the selection of areas to be mined is dictated by the grade and chemical composition of the ore. However, some complexity will be added to mine planning when operating at lower elevations, because the location of the pumping stations, storm water storage sumps and emergency evacuation plans should also be taken into account.

Table 6-1: Uré River water surface levels and freeboard parameters for selected return periods

Return period (years)	Water surface level Uré River (masl)	Freeboard (m)	Levee crest elevation (masl)
25	52.50	> 1.00	> 53.50
100	53.00	> 1.00	> 54.00
1,000	54.50	1.00	55.50
10,000	55.50	1.00	56.50

Source: CMSA (2014)

The design of the levee flood protection structures are based on the 1:10,000-year return period. The total length of these levees will be 3,520 m; the levees will have a crest width of 7 m and a maximum elevation of 60 masl.

6.1.4 Data monitoring systems related to surface water management

Baseline biological investigations have been undertaken as part of the environmental impact assessment (EIA). Monitoring takes place at five locations that correspond to the surface water sampling locations.

6.1.5 Summary comments

- Water supply ponds provide ample storage to meet dry season make-up water requirements for the plant.
- The flood levee design, based on modelled results for the 1: 10,000-year return period, will have a total length of 3,520 m, a crest width of 7 m and a maximum elevation of 60 masl.
- Current mine operations are above the level of the Uré River. However, as the mine gets deeper, water pumping will be required. At this point in time, surface water control measures will not only influence the design of pumping stations, but also mine operation.

6.2 Hydrogeology

The following review is partly based on project work conducted in 2011 by SRK Consulting (US), Inc. SRK Consulting (Australasia) staff who have undertaken the following review were not involved in any way in the 2011 project work.

6.2.1 Hydrogeological environment

The hydrogeology of the Cerro Matoso mine can be characterised as follows:

- Shallow aquifer associated with alluvial sediments (alluvial aquifer)
- Unconfined aquifer associated with clays and lenses of mudstone and sandstone, with low to medium groundwater storage capacity (Cerrito Formation aquifer)
- Very low permeability aquifer (aquiclude) associated with clay and igneous rocks which does not store or transmit groundwater except through fractures (Saprolitic Peridotite aquifer).

6.2.2 Dewatering status

There are no internal or external bores used for dewatering the Cerro Matoso mine at the current depth of mining. There is minimal evidence of seepage water on the pit walls, but there are plans to install horizontal drain holes into the pit walls where seepage water is encountered and is warranted, based on monitoring of pore water pressures.

An in-pit sump has been established at the lowest level of the pit to collect rainfall that falls directly into the pit, runoff that cannot be easily diverted, and seepage water from the pit walls.

SRK (2011) conducted groundwater studies including numerical modelling for the Cerro Matoso MEP. A range of groundwater inflows were predicted, based on the proposed mine plans at the time, in order to help define the dewatering requirements for the MEP, should it proceed. The following maximum groundwater inflows were predicted:

- 2,730 cubic metres per day (m³/d) for the Main Pit
- 1,275 m³/d for the Esmeralda Pit.

With additional contributions from surface water inflows, the predicted total maximum water inflows were as follows:

- 33,650 m³/d for the Main Pit
- 3,775 m³/d for the Esmeralda Pit.

6.2.3 Water management

Groundwater is not exploited as a water source for the site's water supply and hence, there are no groundwater supply borefields. The in-pit sump forms an integral part of the site's water supply, together with pumping from the Uré River.

6.2.4 Summary comments

As there are no substantial occurrences of groundwater at the current depth of mining, active dewatering of the Cerro Matoso mine is not required. A sump at the bottom of the pit is currently used for collecting pit water.

Horizontal drain holes will be installed, if required, to passively remove seepage water and lower pore water pressures behind the pit face in order to improve pit stability.

There is no present need for groundwater supply borefields, as site water demand is met from other water sources.

7 Mining Engineering

7.1 Introduction

The Cerro Matoso FeNi laterite orebody is located on the east side of the Uré River (Figure 7-2), and presents as a cap layer on a 200 m-high hill, making open cut mining operations relatively straight forward. CMSA feeds approximately 3 Mtpa of ore to the primary crusher direct from the pit face or stockpile, with lower grade materials and waste stored to the south of the mining operation.

The CMSA nickel operation is a well-established open cut mining operation. Its business model is predominantly owner-operator. The Main Pit is broken into a number of pit areas as named in Figure 7-1. The trucks, loading units, blasthole drills, blasting units and ancillary equipment are owned by CMSA. Some of the maintenance operations, such as drill maintenance, are completed by specialty contracting services.

CMSA has renewed the existing mining concession until 2029, with a conditional “automatic” extension to 2044.

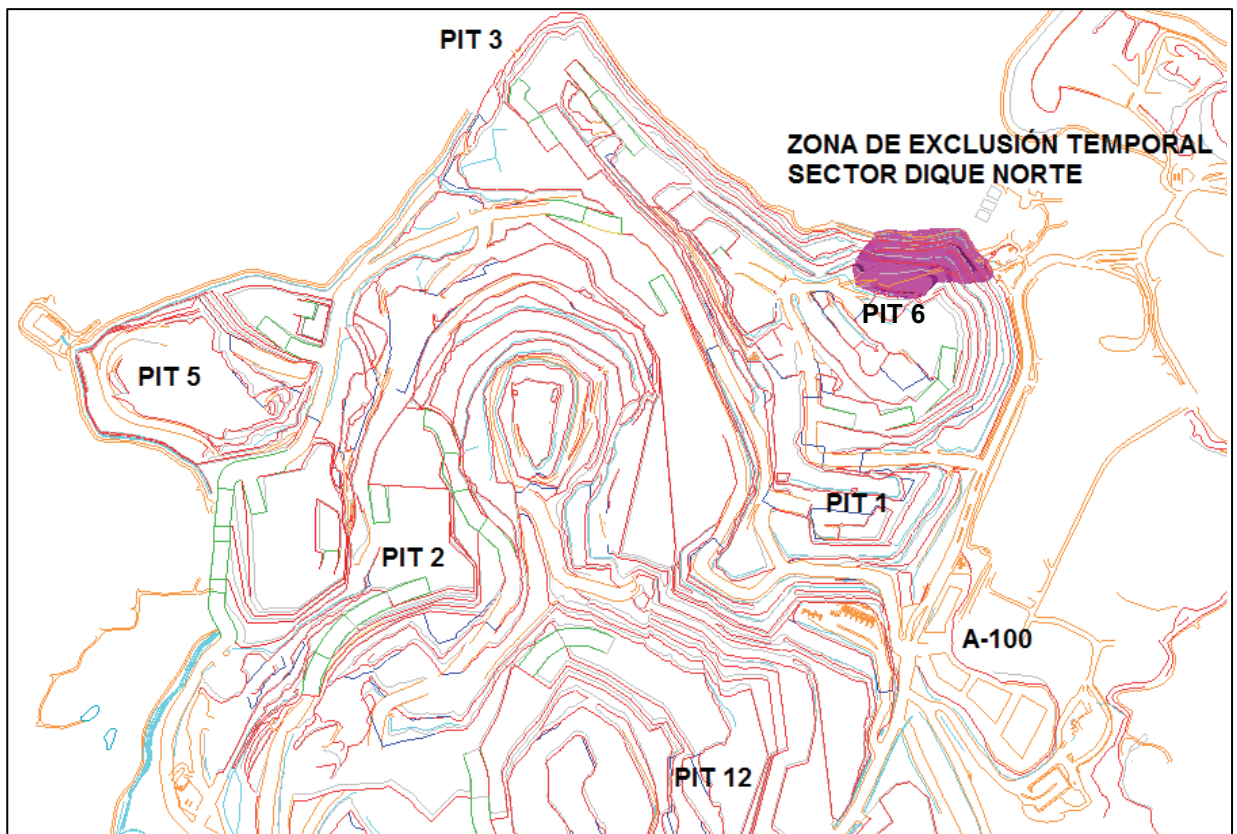

Figure 7-1: Pit numbering of Cerro Matoso pit

Source: CMSA (2014)

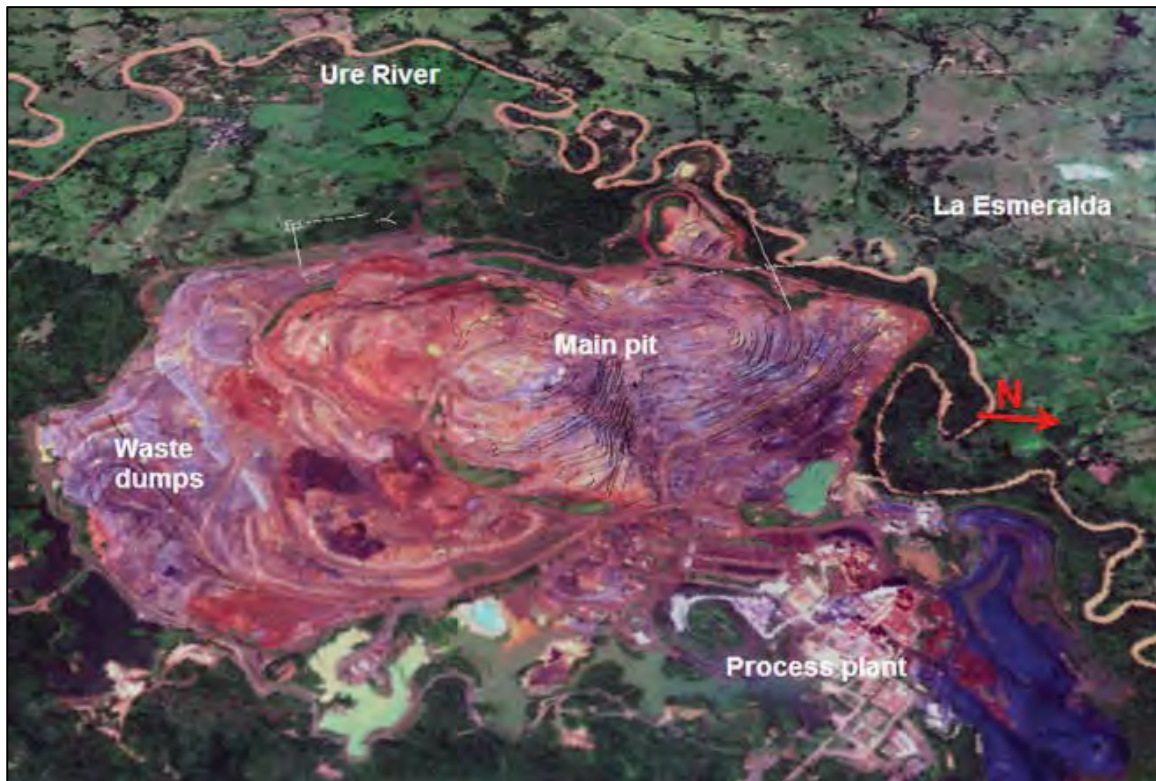

Figure 7-2: Layout of pits and infrastructure

Source: CMSA (2014)

7.2 Mine design and mining method

CMSA uses a traditional truck-and-shovel mining approach. The operation is a mix of selective and bulk mining areas in both ore and waste. The pit design is relatively shallow from ground level (~60 masl), (approximately 70 m to the base of Pit 6 (-7 masl); however, the original hill height was approximately 200 m above the surrounding surface level (260 masl). The mining operation is constrained by the Uré River which has a water level of approximately 44 masl.

7.2.1 Mining method

Due to the lateral extent of the orebody and the trend of Ni grade lowering with depth, the Cerro Matoso pit has generally been mined in a “top-down” method – which is appropriate for this style of orebody. The mining method is traditional truck-and-shovel utilising shovel, excavator and front end loaders (FELs) as required for both primary digging and stockpile rehandle. The excavator in backhoe configuration is the primary loading unit in ore, while shovels and FELs are used in bulkier materials or stockpile reclaim.

Mining activities include removal of any growth medium (topsoil), free-digging, drilling, blasting, loading, hauling and mining support activities. Approximately 10% of the material mined is classed as free-dig (not requiring blasting). Approximately 12% of the ore can be sent directly to the crusher. The remaining ore is sent to the ROM fingers or the off-specification stockpiles near the waste dump, and later rehandled to the crusher as required to achieve the required blend.

The mine is designed in 7 m benches, mined as two (nominal) 3.5 m flitches in selective ore and a 7 m bench in bulk ore and waste. There will be multiple ore faces available at any point in time to achieve a blended feed to the ROM pad (Figure 7-3), while minimising shovel/ excavator movements. If critical short term ex-face blending is required, the FELs are used as FELs are more mobile than the track-mounted equipment. CMSA has used a volume of 4 m (X) x 4 m (Y) x 3.5 m (Z) as the SMU. This SMU is aligned to the capacity of the CAT 777 dump truck.

There is a considerable amount of grade control and sampling required, and a series of intermediate stockpiles have been established immediately adjacent to the primary crusher to permit blending.

Historically, the ore zone was sub-horizontal and presented in thicknesses >50 m in many instances. For the remaining LOM, the ore is trending as narrower ore zones and of a more vertical nature, following structures to depth.

In general, the condition of the pit walls was good. There are effectively two rock types when assessing the walls – highly weathered materials that act like a soil in many cases, and the highly jointed rock mass in the Peridotite material. The Peridotite is relatively hard, but is not conducive to standard pre-splitting techniques; therefore CMSA uses a combination of open-holes against the wall and cushion row blasting. The softer materials are cut back to design by the excavator without the open-hole row of holes being employed.

All blasting is done on 7 m benches. There is opportunity to increase the blasting bench height to 14 m in the bulk mining areas. The 14 m bench blasts have been trialled in the past, but are not a future priority, due to the more selective nature of the ore zones for the remaining LOM.

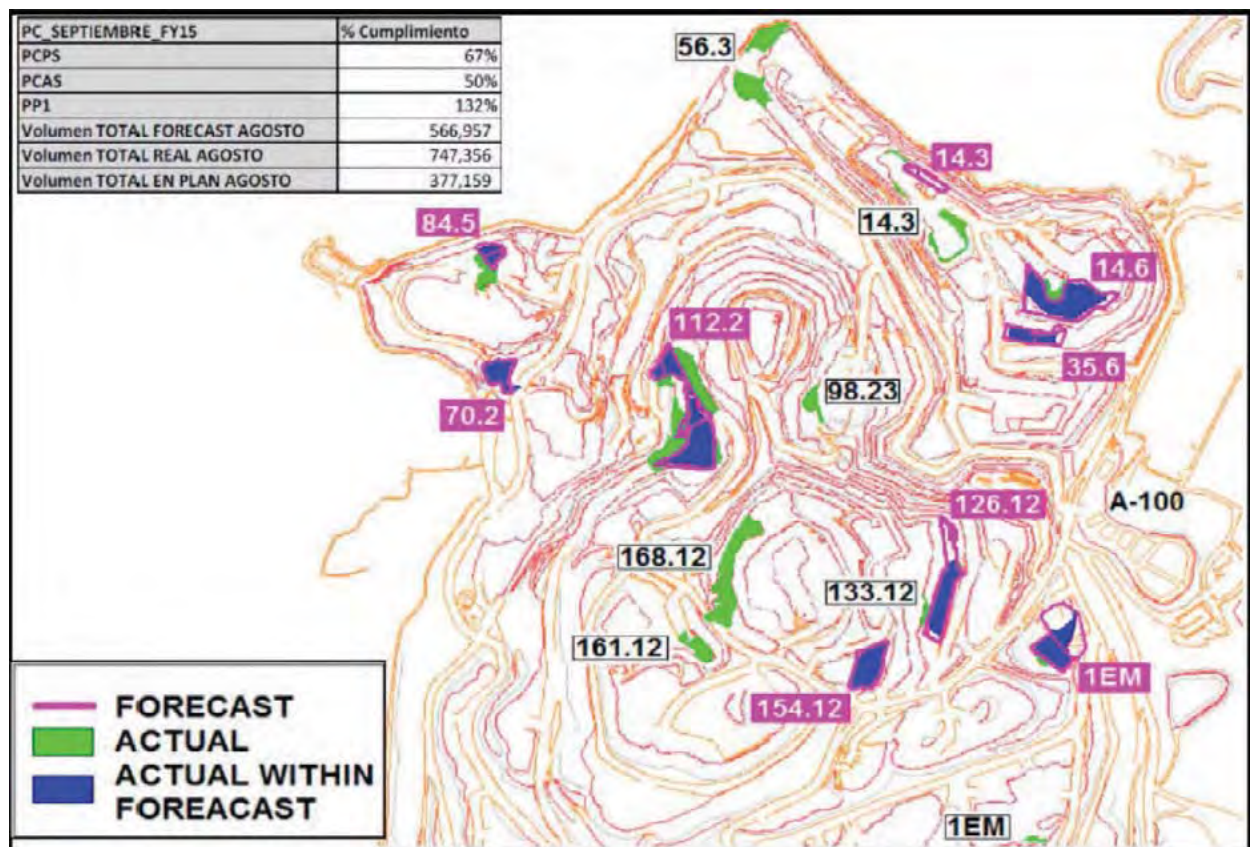

Figure 7-3: Mining location example (compliance to plan) - September 2014

Source: CMSA (2014)

Ore that is on or above the required specification is hauled either directly to the primary crusher or placed on fingers at the ROM for later blending. If there is mineralisation below the Ni cut-off grade, but that contains beneficial Fe, SiO₂, Al₂O₃ or MgO levels such that it is classed as ore when blended, this material is placed on an off-spec dumps (near the waste dump), to be blended into the ROM feed as required.

7.2.2 Mine design

The pit design for the Main Pit has been completed. It is updated only when there are material economic changes to those utilised in the optimisation process that guided the pit design. The following considerations for the mine design are taken into account:

- Ensure mining operability and productivity when accessing ore zones.
- Each bench contains at least one ramp.
- Ramps placed on the footwall mineralisation to reduce potential stripping penalties.
- Peripheral pit ramps terminated at the lowest topography point to minimise ramp lengths.
- Barren zones excluded from ore benches.
- One-way access for up to three benches (or 21 m vertically) in pit bottom locations where mining width is limited.
- Integration of the pit design to base topography.
- The minimum mining width for pushbacks is greater than 30 m.
- Main road maximum gradient is 8% and is two lanes wide (38 m) (CAT 777).
- Secondary road maximum gradient (one way at base of pits) is 10% and is the width of a single lane (21 m).
- Retaining a 30 m buffer from the Uré River, 8 m buffer from upgrading road haulage and crushing pad.
- Incorporation of an allowance for flood protection bunds so that all mine development carried out below 60 masl is protected from the Uré River.
- Design of the Esmeralda haul road exit from the pit to be in a safe site with respect to the location of the Uré River.
- Ensure a major haul road route from the eastern side of the Main Pit to the ROM pad area for the LOM is preserved.

7.2.3 Mine infrastructure

CMSA has an established mining infrastructure, which appears to have been well maintained. The existing mining related infrastructure items include the following:

- Mine maintenance workshop complex with offices – there is a new maintenance workshop and offices currently under construction
- Warehouse for parts and consumables
- Equipment wash pad (pad, pumps, cyclones etc.)
- Diesel fuel storage and fuel dispensing equipment (for current fleet size)
- Emulsion (explosives) plant
- Explosives storage facilities (ammonium nitrate storage and accessory magazines)
- Dispatch control tower
- Mine operations offices.

7.2.4 Waste dump design

The waste dump located at the southern end of the pit is split into two sections. One section is short tipped, with track dozers pushing the waste material over the face. The other waste tip head is a direct tip dump, with the trucks reversing up to the tip edge and tipping directly over the face whenever possible. CMSA allocates the destination for the waste based on material type

classification. The more competent Peridotite material is direct tipped, while the less competent materials are tipped short and pushed by the dozer. These tip heads were inspected during the site visit; the tip heads are of a good standard.

7.2.5 Ore stockpiles

There are three types of “ore” stockpile used by CMSA. The traditional ROM stockpile is a multi-finger operation used to blend ore onto the 100,000 to 150,000 t on-spec “built” stockpile via a stacker. These “built” stockpiles are fed via a reclaimer to the rotary dryers of Line 1 and Line 2. The third “ore” stockpile is the low grade dump. Material that is out of specification on elements other than nickel is stockpiled next to the waste dump. These low grade stockpiles are reclaimed as opportune and are increasingly utilised as the LOM schedule progresses.

7.2.6 Mining equipment

The mining equipment has stayed relatively constant over the LOM. The primary digging units have increased in size from a Hitachi EX1100 (shovel) (6 m³ bucket) to a Hitachi EX1900 (11 m³ bucket). The EX1900s were added in 2013.

CMSA uses a combination of shovels, front end loaders and excavators depending on the bulk/selective nature of the ore and waste being mined.

The trucking fleet has been updated in the last 12 months. CAT 777Fs have replaced the CAT 773s. CMSA still uses five of the CAT 773s to supplement the 14 new CAT 777s. Due to bucket lift height restrictions, CAT 990s FELs are only able to load CAT 773s.

The Hitachi EX1100 is operational, but is used as a back-up production unit.

The current main mining fleet consists of:

- 14 x CAT 777F dump trucks
- 5 x CAT 773C/D dump trucks
- 2 x Hitachi EX1900 excavators
- 1 x Hitachi EX1900 shovel
- 1 x Hitachi EX1100 shovel
- 1 x Hitachi EX1200 excavator
- 3 x CAT 990-II FELs
- 1 x CAT 992K FELs
- 2 x Sandvik Blasthole drill rigs (25KS/245S)
- 8 x CAT D8R Track dozers
- 3 x CAT 16H Motor graders
- 2 x Water trucks (CAT 769/773D).

7.2.7 Maintenance

The mining equipment is maintained by an owner’s maintenance team to a very good standard. Trucks and ancillary equipment are predominantly Caterpillars; while the loading units are Hitachi (shovel and backhoe configurations) and Caterpillar FELs.

Of note is the condition of the older trucks and digging units. The CMSA maintenance regime has been able to maintain high availability (> low 80%’s) for older mining units while keeping maintenance costs of these units below that expected for much newer units. CMSA uses standard component condition monitoring systems. Some of the older CAT 773 fleet have in excess of

70,000 hours and a lower maintenance cost than expected. These older CAT 773 units are generally close to requiring a major rebuild and are being progressively parked-up prior to this expenditure. As such, the salvage value of these units will be low.

A Hitachi EX1100 in shovel configuration is over 15 years old, with more than 70,000 hours and still in operation (as a back-up unit). These units are normally decommissioned at 45,000 hours.

7.3 Mine schedule

CMSA produced a LOM schedule that extends to 2029 (Figure 7-4). Of note is the sharp drop in total tonnes mined from the pit in 2017, dropping from a rate of approximately 13 Mtpa in 2016 to 3 Mtpa in 2017. This is predominantly due to the reduction in waste mining, but also due to an increase in the ore stockpile rehandle to the ROM pad. The tonnes of crusher feed increased marginally from 3.1 Mtpa to 3.3 Mtpa, reacting to the lower Ni feed grades to maintain Ni product tonnes.

Based on past production performance, the production schedule presented for the LOM is achievable, using the equipment and facilities currently on site.

CMSA presents the mining schedule as an LOM schedule, a 5-year plan and 2-year budget, with operational planning being a sub-set of the 2-year budget.

CMSA utilises the Modular Mining *Dispatch* software and associated hardware on the mining equipment. The use of the *Dispatch* system was viewed while on site. The use of *Dispatch* and use of reporting from the *Dispatch* system is being employed by CMSA to help optimise the mining operation.

CMSA utilised the BHP Billiton developed *Blasor 10* software to optimise the production schedule while maintaining the required blended feed to the primary crusher. The production schedule conforms to the June 2014 Reserve estimated in this report.

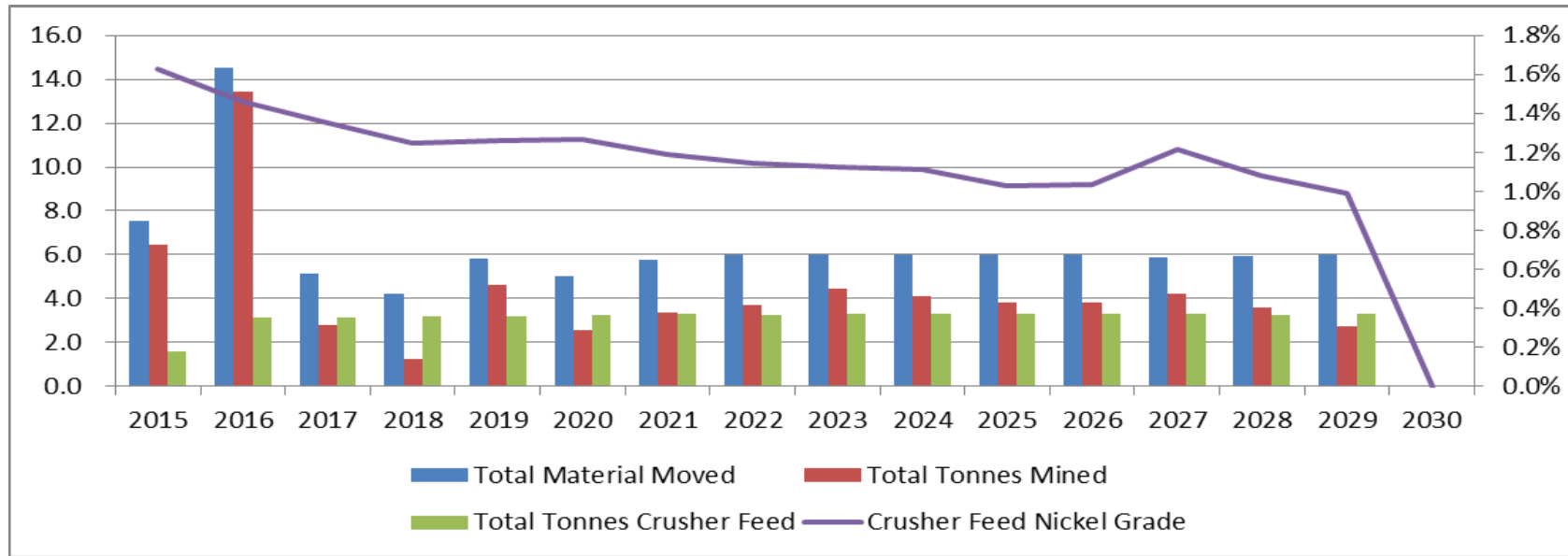

Note: Only 6 months reported in the CY2015 (Jan 2015 to Jun 2015)

Figure 7-4: Graphical presentation of LOM production schedule physicals by year

Source: CMSA (2014)

7.4 Historical operating performance

Table 7-1 presents the historical performance of the mining operation since 2009. The capacity of the mining equipment peaked at a total movement of 23 Mtpa in 2012 and 2014. This capacity is significantly more than that required for the current LOMP.

Table 7-1: Historical tonnes and grade mined

Mining History	Unit	FY09	FY10	FY11	FY12	FY13	FY14
Ore mined	wmt	3,250,695	3,086,086	2,413,757	2,494,236	2,794,590	2,071,395
Ni grade	%	1.99%	1.98%	1.96%	1.96%	2.00%	1.89%
Stockpile (Lean Ore)	wmt	4,430,104	4,390,507	4,417,767	6,570,649	6,220,273	6,418,614
Waste	wmt	5,661,359	5,497,908	6,881,686	8,626,383	7,025,635	8,197,336
Crushed ore	wmt	3,236,404	3,541,064	2,803,113	3,211,142	3,407,241	3,250,404
Si/Mg ratio		2.68	2.68	2.30	1.87	1.83	1.85
Total Material Moved	wmt	17,888,883	17,994,410	18,822,604	23,928,868	21,841,456	23,246,648
Other Material Moved (slag, mud, etc.)	wmt	4,530,408	5,019,908	5,109,394	6,237,599	5,800,958	6,425,852

7.5 Planned operating expenditure

The mining cost is approximately 11% of the total Project operating cost (Figure 7-5). In 2015 and 2016, the mining cost is approximately US\$22/t crusher feed. With reduced waste mining in 2017, the mining cost drops to approximately US\$12/t of crusher feed for remaining LOM (Figure 7-6).

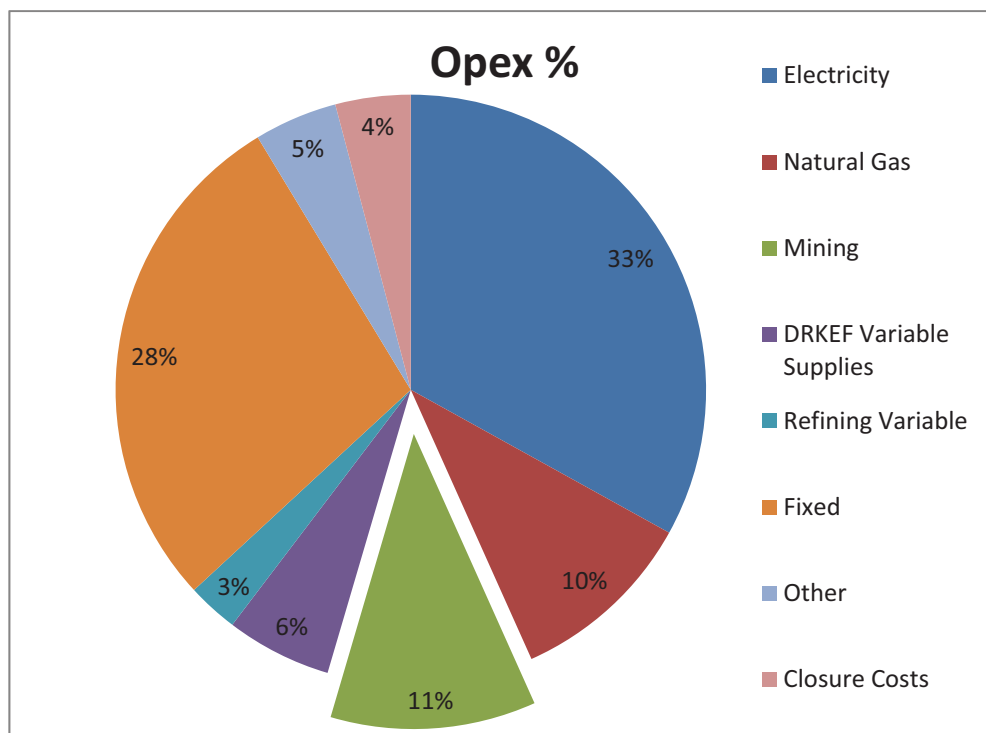

Figure 7-5: Mining as a percentage of total operating expenditure

Source: CMSA (2014)

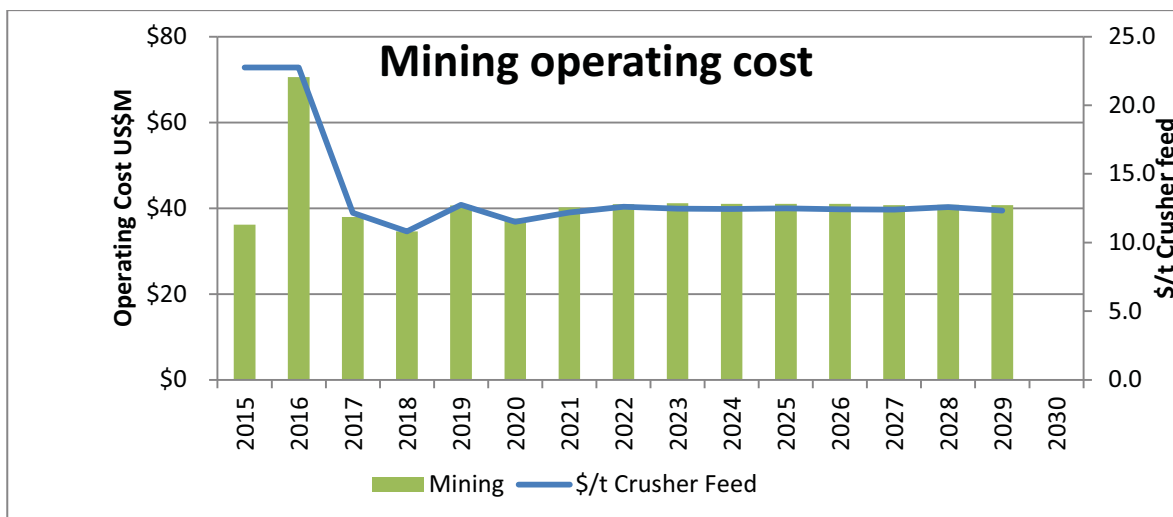

Figure 7-6: LOM mining operation costs

Source: CMSA (2014)

7.6 Capital expenditure

CMSA has completed a significant upgrade to the mining fleet over the last 12 to 18 months. In all, 14 x CAT 777 units, 3 x Hitachi EX1900s, 2 x CAT 16M motor grader and a CAT D9T track dozer have been delivered to site. Table 7-2 shows the sustaining capital for the next five years. CMSA has a good maintenance record, maintaining industry standard availability, life of machine and achieving a low maintenance cost per hour. There is no reason identified that this approach to maintenance would not be maintained, going forward.

Table 7-2: Mining equipment sustaining capital from the FY15-FY19 5 year plan

Year	FY15	FY16	FY17	FY18	FY19
US\$M	3.43	4.26	8.71	6.54	5.11

CMSA has under construction a new maintenance workshop for mine mobile equipment to suit the new CAT 777 fleet and allow the separation of light and heavy vehicles. This workshop is planned to be handed over to the Maintenance department in April 2015. The use of the old (existing) workshop is still under internal discussion; however, the likely option is for use as an undercover product stockpile.

The light vehicles utilised by CMSA are all leased, with maintenance costs included in the leasing charge. All light vehicle maintenance is performed off-site.

7.7 Operational improvement

CMSA is not planning further material mining equipment operational improvements. The upgrade to the larger mining units, from CAT 773 to CAT 777 trucks and to the larger Hitachi EX1900s has been completed. The used of this sized equipment is planned for the remainder of the LOM.

Esmeralda

Esmeralda is a proposed open pit deposit on the other side of the Uré River, 500 m north west of the Cerro Matoso open pit. The Esmeralda deposit has been studied and deemed viable pending the granting of a Social and Environmental licence. As this licence has not yet been granted, CMSA has removed the Esmeralda deposit from the Reserves and therefore does not form part of current production schedules.

The pit optimisation and production scheduling modelling demonstrates that Esmeralda adds approximately 6 Mt of Reserves grading 1.65% Ni grade. This additional ore increases the Ni grade to crusher feed in the period FY18 to FY 22 by 15% from 1.2% to 1.4% Ni.

7.8 Risk and opportunity

The production schedule produced has multiple material destinations and lithology types for each block in the Reserve block model (12.5 x 12.5 x 7 m block size) used for scheduling. While it is technically possible to utilise the stated SMU size (4 x 4 x 3.5 m) to create multiple destinations for a single “parent” block, operationally this is not likely to occur as planned. On inspection of the Reserve model, the *Blasor* software is utilising multiple destinations for a single “parent” block.

CMSA has reported that the June 2014 Ore Reserve was produced by a depletion exercise based on the June 2013 Reserve. Considering the historical reconciliation variance, the use of a detailed survey of the pit and stockpiles is a better basis for all Reserve estimates and should have been used.

Currently, CMSA utilises the purchasing power of BHP Billiton for all mining equipment and parts. It is not clear whether CMSA will have access to the same level of discount after the demerger. Both sustaining and replacement capital may be affected by this issue for the remaining LOM.

With the increase in the size of the mining units (excavators and shovels), ore loss and dilution parameters may negatively affect ore grades. The mining units are capable of digging to required boundaries, but at a reduced productivity.

There is approximately half the crusher feed coming from the “long term” stockpiles over the LOM. In years 2017 onward, the stockpile ore makes up a majority of the crusher feed. If the density of this stockpile material is not correct, the stated ore reserves will be affected. Stockpile density is inherently difficult to determine.

The current mining fleet is capable of producing well in excess of 14 Mtpa of material movement presented in the production schedule. While it is appreciated that this fleet is planned to also service the Esmeralda mining operations once licencing is approved, there is clearly more equipment on site than is required to service the current production schedule from 2017 onwards.

CMSA has had a relatively stable workforce; many employees have been with the company for over 15 years. The staff turnover is approximately 3% and the blue collar workforce is below 1%. The workforce is composed of about 78% locals and 22% employed from outside the Monteria area. This retention of skills is of significant value to the productivity of the mining operation. There is a risk that the current optimisation initiatives increase the turnover of these skilled employees, resulting in lower productivity, higher costs and potentially ore quality issues. In discussions with CMSA, these potential issues are acknowledged and a contingency is being developed.

7.9 Summary comments

The mining operation utilises equipment that is suited to the operational characteristics of the Cerro Matoso pits. The relatively long-term employment of many employees has resulted in skilled operators and maintainers being available. As a result, operational and maintenance performance is considered by SRK to be above industry average and well suited to the LOMP and associated Reserve estimate.

The supporting services to the mining operation (such as geotechnical, grade control, *Dispatch*, and planning) have adequate manning levels and utilise industry standard equipment and techniques.

Operating costs and planned capital expenditure are appropriate based on SRK’s examination of site.

CMSA plans to commence mining at Esmeralda as soon as the Social and Environmental licence is granted. It is envisaged that the start of construction for this deposit will be in FY2016. The mining of Esmeralda is significant to CMSA as it lifts the Project Ni grade by approximately 0.2% Ni to 1.4% Ni (average of Esmeralda LOM), with chemically similar ore to that already being fed to the pyrometallurgical process plant.

8 Mineral Processing

8.1 Processing History

Detailed exploration commenced in 1964 and pilot testing in 1977. The pilot testing was based on the Rotary Kiln-Electric Furnace (RK-EF) process that had been developed by Elkem of Norway in the early 1950s and had been adopted for plants treating similar nickel laterite ores in New Caledonia and Japan.

The plant has steadily increased processing capacity over the years and now has two RK-EK lines (Line 1 and Line 2) that allow an ore throughput of 3 Mtpa.

In 2008, the original furnace of Line 1 was completely rebuilt, incorporating the enhancements that had been incorporated into furnace 2 and a power increase from 66 to 70 mW. As a result, the new furnace 1 was superior in performance to furnace 2.

After 32 years, plant operations are now mature and low staff turnover has ensured a high level of process understanding and technical competence among both staff and operating personnel. A significant challenge for the future is the declining grade of the ore extracted from the pit. A consequence of the declining availability of ore of different SiO₂, MgO and Fe content is a reduced blending flexibility for feed of the desired furnace slag chemistry. These issues are being addressed, but the outcomes are still uncertain. A successful implementation of the Stage 2 Upgrade Project could allow kiln feed grades to increase by 13.5% and the application of the Stockpile Chemistry Optimization Study (SCOP) parameters will allow access to currently quarantined higher nickel (higher silica) grade ores in the mine.

It can be noted (refer Figure 8-1) that during the operation of the single furnace up until 2000, the feed grade was higher than 2.8% Ni, but declined to below 2.3% Ni by 2003 when the second line reached full rate.

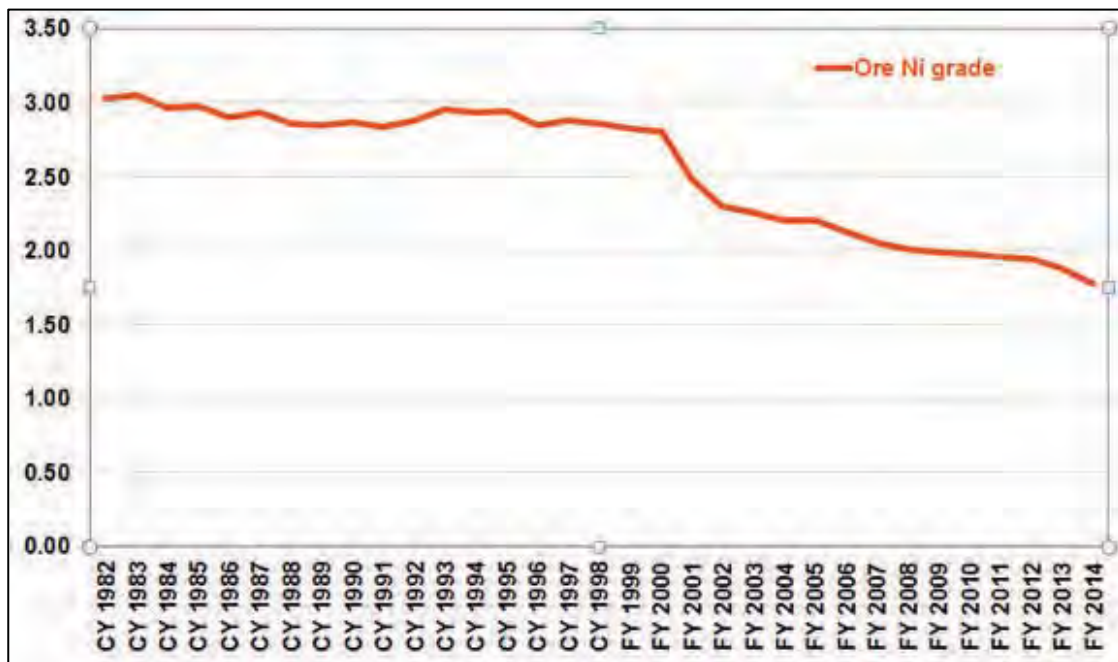

Figure 8-1: % Ni to Crusher 1982 - 2014

The changes to the mine cut-off Ni grade shown in Figure 8-2 can be matched to the declining crusher feed grade above. In 2001, the cut-off grade was lowered from 1.5 to 1.1% Ni, to 1.0% Ni in 2004 and 0.6% Ni in 2008.

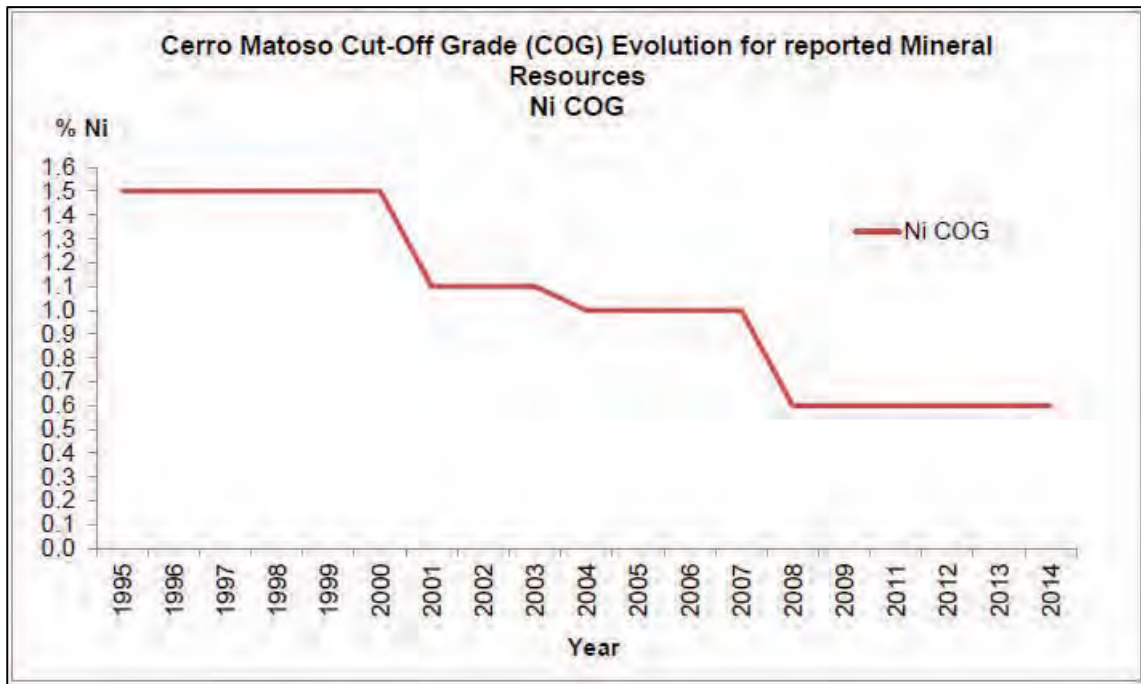

Figure 8-2: Progressive Ni cut-off grade

Figure 8-3 shows the projected future crusher feed grades (BC) between 2015 and 2019 (with and without Esmeralda pit (MEP)). In 2015, the grade is expected to be 1.6% Ni, but declines to 1.2% Ni by 2018 (without Esmeralda ore) and continues down to 1.0% Ni by 2025.

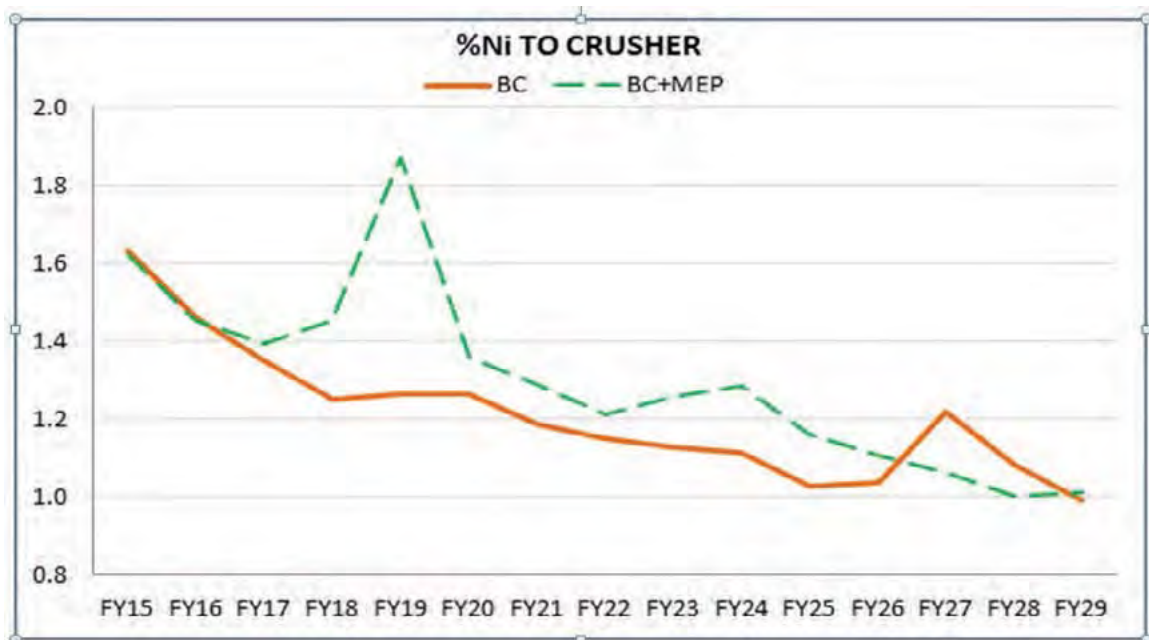

Figure 8-3: Projected crusher feed grades

8.2 Plant operations

Figure 8-4 presents the CMSA processing flowsheet that is described in the following sections.

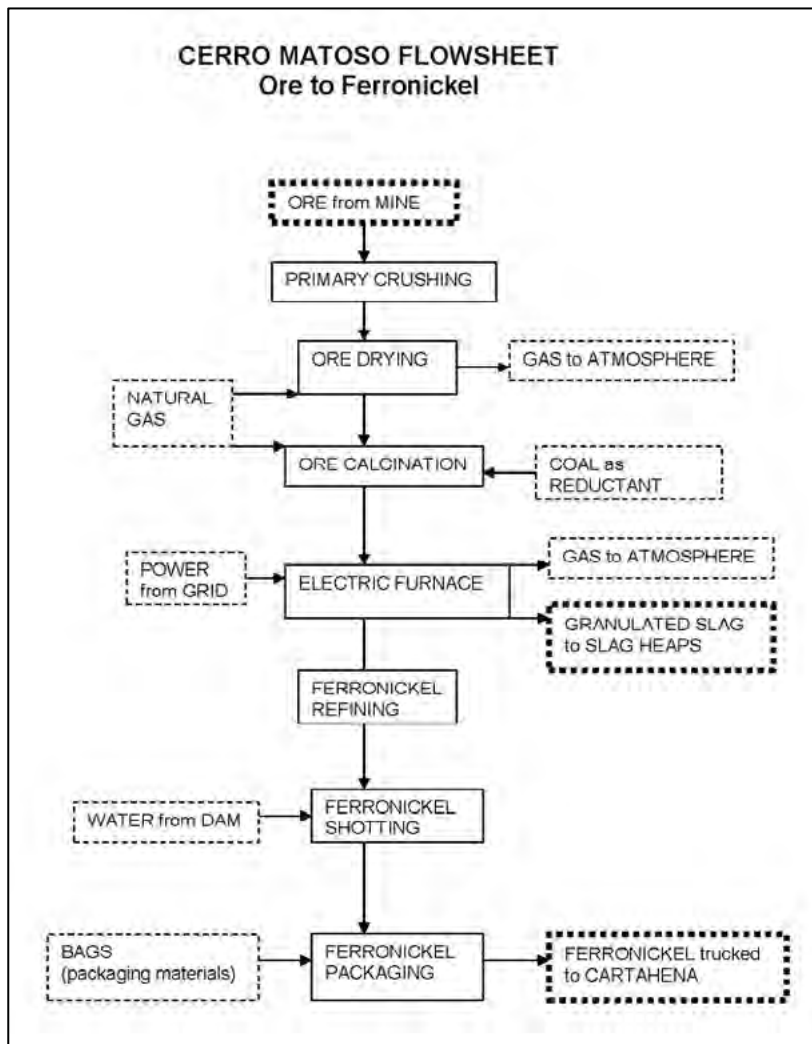

Figure 8-4: Processing flowsheet

8.2.1 Stockpiles and crusher feed

Historically, the mine stripping ratio has been about 4:1, with the original cut-off grade of 1.5% Ni lowered to 1.1% Ni in 2001, 1.0% Ni in 2005 and 0.7% Ni in 2007, as the grade of the remaining ore declined. The overburden has always been selectively subdivided into either waste or low grade ore, stockpiled for future use. The proportions of the split depended on the grade being mined at any time and a higher proportion went to the stockpiles in the early years when the cut-off grade was 1.5% Ni, than at present. There is currently 24 Mt of stockpiled ore with an average grade 1.3% Ni and 24 Mt of *in situ* ore of 1.2% Ni. Reclaim of the stockpiled ore commenced in 2013 and in 2014 will comprise 50% of the 3 Mt of ore fed to the crusher. Currently, the mining rate of *in situ* ore is 3 Mtpa, with 1.5 Mtpa delivered to the stockpile and 1.5 Mtpa, to the crusher. Ore is double-handled from stockpiles to allow blending of the SiO₂, MgO and Fe in the smelter feed to control slag chemistry, which is becoming increasingly problematic as the available ore of variable chemistry declines. The reclaim of some stockpiled ore as plant feed will continue until 2029.

In 2016, total mined material movement is projected to significantly decline from about 15 Mtpa to about 5 Mtpa, when ore delivery to the stockpile ceases and the proportion of stockpiled ore reclaimed to crusher feed increases.

Ore is delivered to the plant feed primary stockpile area where it has been typically segregated in up to 10 ROM fingers categorised by chemical composition (e.g. Ni, Fe, SiO₂ & MgO). The two stages of crushing reduce the size from a nominal minus 600 mm to minus 50 mm. The minus 50 mm ore is stacked on one of two blending piles by a travelling stacker conveyor. Each stockpile has a capacity of 120,000 t, equivalent to 30 days' storage at plant feed rate 8,100 tonnes per day (tpd). Standard operating practice is to have one stockpile building while reclaiming from the other. The grade of ore on the 120,000 t stockpile being reclaimed at the time of site visit was 1.55% Ni.

A bridge-type stacker-reclaimer transfers the blended ore from the stockpiles to the ore reclaim conveyors, which run the length of the stockpiles. Each of the two conveyors discharge ore to its associated dryer feed bin located at the south end of the stockpiles.

8.2.2 Drying

The free moisture content of the ore is variable, depending on the season of the year and can range from 17 to 37%. The drying plant was designed to handle 30% moisture in ore and the annual average is typically <24%. The ore also typically contains 10.5% bound moisture as, crystallisation water, mineral hydroxides and other forms that evaporate between 400°C and 900°C and is removed in the following calcination (pre-reduction) kilns. The exhaust gas from the dryers is cleaned of entrained fines in electrostatic precipitators.

Each of the two co-current gas fired dryers (5.5 m diameter, 45 m long) reduces the free moisture content to between 4.5% and 11% and the dried ore is stored in three silos, each of 1,200 t capacity. If the three silos are full, the dry ore is diverted to a covered stockpile area. The silos discharge ore onto conveyors that deliver to the rotary kilns which typically operate with 90% availability.

Table 8-1: Current dryer feed ore composition

Ni%	1.6
Fe%	<13.5
Co%	<0.088
Mg%	9
SiO ₂ %	46
SiO ₂ : MgO	<1.9
Al ₂ O ₃ %	<4.95

8.2.3 Ore upgrading

In 2003, an ore upgrading circuit was installed based on the fact that after crushing and drying the larger rocks being harder (higher silica content) can be screened from the higher nickel content fines. The screen aperture is interchangeable between 45 and 55 mm, depending on the characteristics of the ore being processed. The result is typically a 10.4% mass reject and 6.3% increase in the ore grade to the kiln. The nickel content of the oversize rejects is still relatively high (close to 1.0% Ni) and is trucked to the low grade ore stockpile, rather than to waste. Recently, the dryer discharge grade has been 1.7% Ni and the reject oversize 0.8% Ni, with nickel recovery of 93%. The typical upgrade factors for relevant elements are shown in Table 8-2.

Table 8-2: Upgrading parameters

Upgrading Factors	%
Ore Mass Rejected	10.4
Ni	6.30
Fe	4.5
MgO	-3.6
SiO ₂	-0.6
Al ₂ O ₃	4.9

Note: Silica and magnesia percentage in the upgraded ore is lower.

By way of example, in FY2013, the rejected material comprised 11.2% of the feed and contained 0.91% Ni, resulting in a 6.7% nickel upgrade. The nickel recovery in the upgrade plant undersize is typically about 92%.

If the Upgrade 2 circuit now under study is installed, the existing post dryer upgrade circuit will become redundant and will be bypassed, resulting in nickel upgrade rising from 6.3% to 12.7%.

8.2.4 Calcination

The dried and upgraded ore is conveyed to one of the two calcination kiln silos.

The calcination, or pre-reduction, of the ore is undertaken in gas fired rotary kilns which have 5% - 7% coal added as a reductant (100,000 tpa coal consumed). A higher iron content of the feed ore requires more coal addition for pre-reduction.

Each kiln has a nominal capacity of 175 tph (4,200 tpd), equivalent to 2,700,000 tpa for the two kilns at 90% availability. The counter-current fired kilns are operated at a calcine discharge temperature of about 800°C. The ore mass of the solids falls by about 10% as the last of the free moisture, followed by the bound moisture, is removed. The residence time in the kilns is about 2.5 hours and for every 100 t of ore feed, about 90 t of calcine is produced. About 75% of the nickel oxide and 30% of the iron oxide is reduced in the kiln. The exit gas passes through electrostatic precipitators for the removal of particulates. A significant improvement to kiln performance has been achieved by pugging the 30 - 40 tph of dust from the off-gas lines of the kilns and furnaces and feeding it as a paste to extruding machines that produce extruded slugs of compacted dust that have superior resistance to breakdown than the green pellets from the original drum pelletisers. The dust slugs are fed to the kilns, resulting in a reduced circulating dust load and lower gas usage.

8.2.5 Smelting

The chemistry of the calcine is important in regard to the SiO₂: MgO ratio, as high silica slag from laterite ores is corrosive to furnace magnesite refractory bricks. At Cerro Matoso, the SiO₂: MgO ratio is currently maintained at < 1.9:1, resulting in some of the high nickel, high silica ore in the mine being quarantined. As discussed later, research work is proceeding to establish that the ratio can be safely increased, allowing some of the quarantined ore to be mined.

Each of the two furnaces is 21 m in diameter, apparently the largest circular furnaces that have been installed in the world (some rectangular furnaces are larger). Each has a design power rating of 105 mW, but typically operates at 75 mW. Each furnace has three graphite electrodes, 1.8 m in diameter, between which an arc is struck through the slag.

The recovery in the furnaces is typically between 90% and 92% for nickel and 30 to 35% for iron, with most of the reduction actually occurring in the rotary kiln (coal addition), not in the electric furnace. On the basis that the current upgrade plant (post dryers) screening plant nickel recovery is

90%, the overall recovery from crusher feed to ferronickel product is typically 82%.

The molten ferronickel is tapped from the furnace at a temperature of about 1,480 °C into 50 t holding crucibles, which are moved to the refining area. The molten slag at 1,630 °C is tapped from higher in the furnace and the launder sprayed with a water stream to granulate the slag to a coarse sand size. The granulated slag water mix exits the launder into a sump and the slag is removed from the sump by a screw conveyor that discharges onto a belt conveyor, which in turn discharges into a holding hopper in which it is transported to a slag stack. The analysis of the current slag is typically, SiO₂:MgO = 2.0, Fe = 11-12%, Al₂O₃ = 2.5%, Ni = 1%. The nickel loss in the slag is about 50% as metallic alloy and 50% as oxide. The entrained fine alloy particles are magnetic, offering the chance for later separation from ground slag.

As a result of a change in the mine plan in 2011 the SiO₂:MgO ratio declined and it was necessary to move the operating ratio from the right to left side of the eutectic valley (from 2.7:1 to 1.9:1) with the Fe content of the slag consequently declining from 14.5% to 12% and the nickel content from 0.25% to 0.10%. The FeNi produced in the furnaces currently contains 29 - 31% nickel and will continue to decline as the nickel content of the ore declines and the iron content increases.

8.2.6 Ferronickel refining, shotting and packaging

In the refining process, the molten ferronickel in the crucible is heated by three immersed electrodes and reagents are added to eliminate phosphorus and sulphur. The required reagents are normally aluminium dust, ferro-silicon, lime, oxygen and nitrogen.

Following the addition and mixing of the refining agents, the FeNi is discharged as a molten stream into shotting launders, where it is rapidly cooled in a high volume jet of water, resulting in the formation of fFeNi shot pellets. The shot falls to the bottom of the launder sump and is pumped to a rotary dryer. The dryer discharge is screened to different shot sizes that comply with customer requirements. The shot is packaged either bulk in containers or in 2 t bags. When the Project started, the FeNi product was typically 45 - 50% Ni, but declining Ni grade has meant that by 2029, the nickel content will fall to about 16% Ni.



Figure 8-5: Ferronickel product – packaging either in 2 t bags or bulk containers

8.2.7 Slag reprocessing

The prospect for slag re-processing arose from the relatively low nickel recovery in the electric furnace and the presence of magnetic metallic nickel alloy in the slag, in the early years of the Project. The small FeNi inclusions had insufficient time to settle through the slag into the matte

before slag tapping. Testwork confirmed that the inclusions could be liberated by wet grinding and recovered as a concentrate from the slag slurry by using magnetic drum separators.

The MNR plant commence operation in 2007, but the low nickel recovery and high operating costs of the slag plant severely impacted its profitability and it was subsequently shut in September 2013. The plant was restarted again in October 2014 to assess some changed operating parameters, but because of the high operating cost and low current nickel prices, the slag retreatment plant is still not profitable and it is likely to be shut again in early 2015 and the asset written off.

8.3 Heap leaching project

A pilot plant heap leach facility has been established and was tested between 2006 and 2012. As of 2013, the project is on hold.

8.4 Process optimisation studies

8.4.1 Stockpile Chemistry Optimisation Project (SCOP)

The operating strategy of the Cerro Matoso furnace is based on the physical and chemical properties of the slag and metal produced. The restrictions thus imposed relate to the composition of the ore and are imposed to ensure the following:

- Metallurgical performance relating to slag fluidity and nickel recovery
- Prevention of excessive slag attack on the furnace lining and risk of a slag “run-out”, or explosion and injury to operating personnel.

The restrictions have meant that a considerable amount of high silica, high nickel ore in the mine has been quarantined. This project is investigating the potential to operate the CMSA electric furnaces with a broader SiO₂: MgO range (up to a ratio of 2.2:1 compared with the current <1.86:1) without increasing nickel loss or causing operational problems. The project had been prompted by exploration identifying a high Ni grade and very high SiO₂: MgO ratio of >5:1 ore zone in Pit 2 South near the Uré River.

A number of simulations of the metallurgical process variables have been undertaken with the results looking positive for the implementation of SCOP. The variables are as follows:

- Chemical composition of the slag and metal
- Liquidus temperature of the slag and metal
- Slag and metal overheating
- Electrical resistivity of the slag
- Viscosity of the slag.

The testwork was undertaken at the University of Toronto. The next step should be the running of some pilot testing to validate the simulation results. It needs to be established that the current copper cooling inserts in the furnace walls are able to handle the thermal change. The cost of this remaining research work has been estimated as US\$350,000. No Capex would be required to implement the SCOP which could occur by the end of 2015, with an appropriate change to the mining plan. No evaluations were available to SRK to demonstrate the net return after implementation. The testwork will also be important to illustrate to the operating staff in the smelter that the changes will still allow a safe working environment. It is estimated by plant personnel that the implementation of the SCOP will allow the release of sufficient extra ore (~400,000 t) to allow the production of an extra 6,400 t Ni during the next 15 years.

8.4.2 Ore Upgrading 2

With the advent of declining grades, nickel production will fall to about 25,000 tpa. Consequently, plant operating costs will increase proportionally, unless remedial action is taken. This has driven the study of a project to upgrade the ore by nearly 13% with the rejection of 20% of the ore mass before drying, as implemented by SLN and Falcondo Dominicana. The piloting trials have confirmed a base case configuration whereby equipment would be installed comprising a 1,000 tph Wobbler followed by a crusher and 600 tph Rubbler prior to stockpiling the upgraded ore. The lower nickel grade silica core rocks to be rejected will have adhering high grade ore removed in the Rubbler.

The new project has been designated Upgrading 2, with the following expected benefits:

- Allow the processing of all existing mine reserves
- Improve the economics of processing new lower grade resources in the region
- Allow the economic re-processing of the stockpiled reject material from the Upgrade 1 plant.

Upgrading 2 has the potential to allow increased annual FeNi production in the existing RK-EF plant, with minimal capital expenditure. Once the Upgrade 2 plant is installed, the Upgrade 1 plant after the dryers would be redundant and bypassed.

Technical risk for the project is minimised by the flowsheet and the proposed plant not having any novel features. The SLN mines in New Caledonia, which supply saprolite ore to the Doniambo RK-EF smelter, have successfully used an essentially identical circuit for many years to successfully upgrade their smelter feed, as has the mine supplying saprolite ore to Falcondo Dominica RK-EF plant in the Dominican Republic.

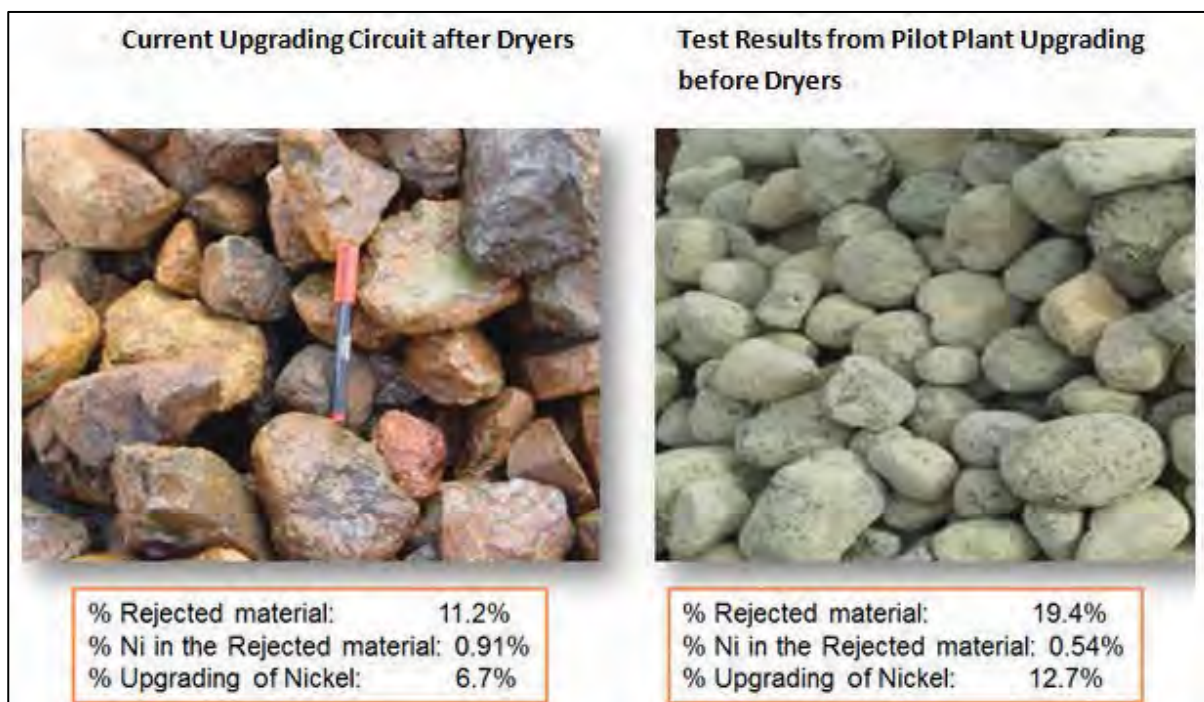

Figure 8-6: Upgrade plant comparison

Source: CMSA (2014)

The piloting trials have confirmed a base case configuration of 1,000 tph Wobbler followed by a crusher and 600 tph Rubbler, prior to stockpiling the upgraded ore. The low Ni grade silica rocks have any adhering high grade fine ore removed in the Rubbler. The nickel recovery in Upgrade 2 is projected to be 91%, compared with 93% in Upgrade 1, but about double the mass is rejected.

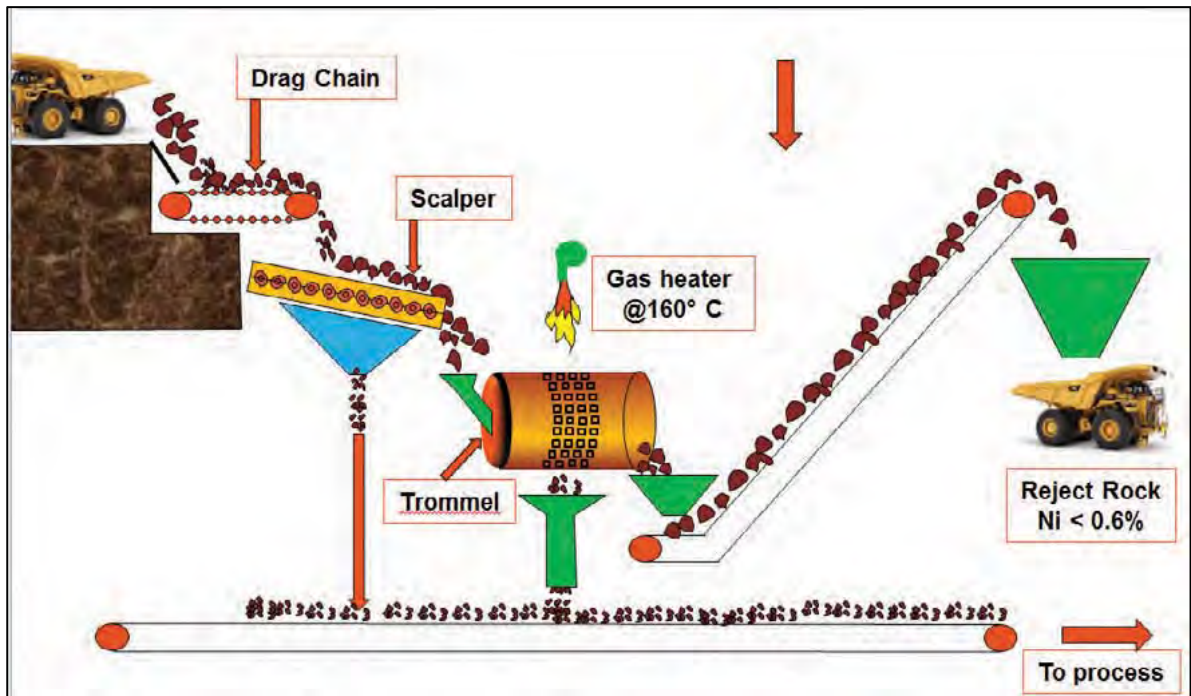

Figure 8-7: Simplified flowsheet of pilot plant under construction for testing in December

Source: CMSA (2014)

The commercial plant would have a 1,200 tph feed rate with total rejects of 250 tph and 950 tph upgraded ore as dryer feed. The dryer load is reduced by 20%.

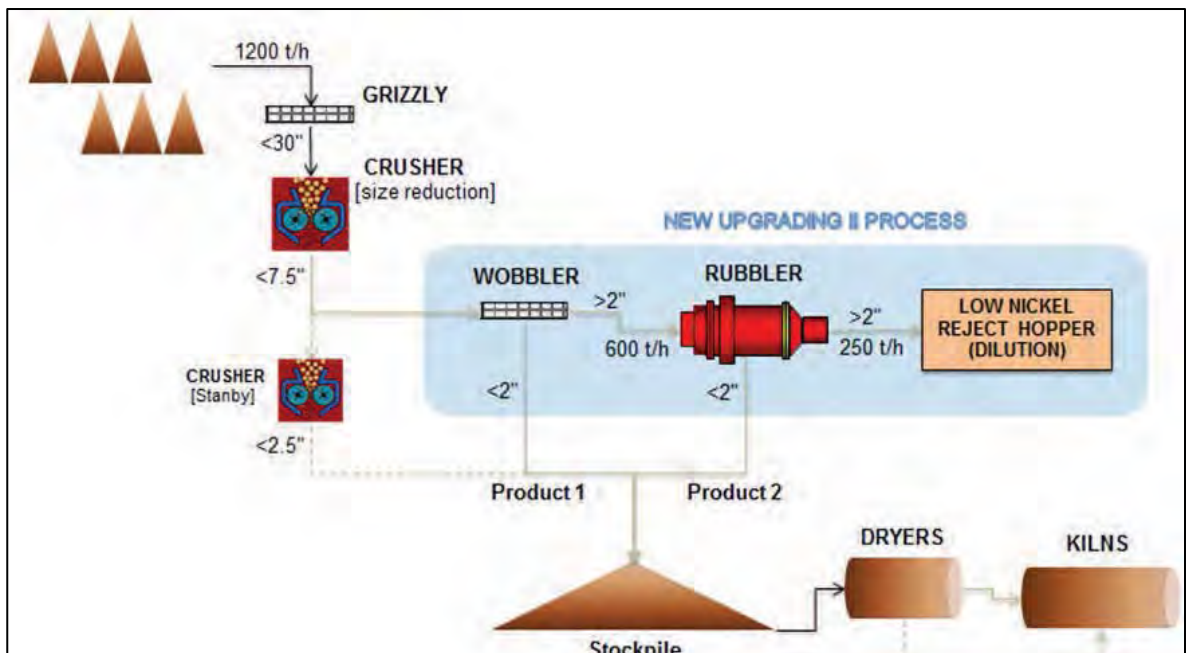

Figure 8-8: Flowsheet of proposed Upgrade 2 plant

Source: CMSA (2014)

The capital cost of the installation of the new circuit has been estimated as US\$30M and a decision is expected in early 2015.

In summary, Upgrading 2 has the following benefits compared with Upgrade 1:

- Rejects 19.4% of material containing 0.54% Ni, before dryers, compared to 11.2% containing 0.91% Ni after dryers. Currently, energy is wasted in drying material to be rejected in Upgrade 1.
- Achieves 12.7% nickel upgrade compared to 6.7%, and recovers 30% of nickel that is now sent to rejects.
- Allows the processing of all existing mine reserves.
- Improves the economics of processing new lower grade resources in the region.
- Allows the stockpiled reject material from the Upgrade 1 plant to be economically reprocessed.
- There is potential to increase FeNi production in the existing RK-EF plant, with minimal capital expenditure.

It is envisaged that project approval could be gained by September 2016 and full production achieved in November 2017. In 2017, the ore feed grade is projected to be 1.40% Ni and a 13.5% upgrade would result in upgraded feed of 1.60% Ni.

8.4.3 Optimised Base Plan

A number of initiatives have commenced to improve the project economics at this time of declining ore grades and low nickel price, as below:

- Productivity improvements to sustain current margins
- Implementation of a de-bottlenecking program within the constraint of sustaining capex, to allow the throughput of each kiln to increase by 7 tph (100,000 tpa ore, ~1,300 tpa Ni)
- Upgrading of the off-gas cleaning for Line 2 as a compliance project
- Upgrading of the in-pit exploration program to extend resources and increase confidence in mine planning models to ensure consistency in furnace feed
- Energy strategy to include option of a third party on-site gas power generation, with aim of reducing the current power costs by ~6%.

8.5 Costs

8.5.1 Operating cost

Electricity purchased from the grid represents the highest single operating cost at for CMSA, at 34 - 36% of the total. Of the 1,300 mW of electricity purchased per annum, 84% is required to power the two electric arc furnaces. CMSA has a contractual agreement allowing 230 mW to be drawn from the grid, but typically Cerro Matos draws only 175 mW. As the Ni grade continues to fall over the next 15 years, the power consumed per unit of nickel produced is set to double.

Since the 2001 merger of BHP and Billiton, the ore grade has fallen from 2.4% Ni to 1.6% Ni and the cash costs have increased from US\$1.35/lb Ni in 2002 to about US\$4.83/lb Ni in 2014. In 2012, Government Royalty rates were increased from 12% to 13%, as part of the re-negotiations for the concession extension.

Table 8-3 is a summary of Cash Operating Costs at the RK-EF Plant, as at October 2014 (year to date).

CMSA management is aware that the current low nickel prices and falling Ni grade make it essential that cost cutting is implemented at all levels and action has already been initiated.

Table 8-3: Plant operating costs, YTD October 2014

US\$/t ore to kiln	US\$/lb Ni Produced
117	3.74

Note: Costs as presented as at October 2014 (YTD) are based on the current feed profile, i.e. ~1.6% Ni feed.

8.5.2 Energy costs – Electricity, Gas, Coal

Table 8-4 shows the combined cost of Electricity, Gas and Coal constitutes 44% of the total mine and plant cost. CMSA has initiated a number of studies into ways of reducing the cost of power, gas and coal. The 100,000 tpa of coal purchased is currently sourced from a mine about 16 km from the Cerro Matoso site. Competition for coal supply is limited, as the nearest alternative sources of coal are several hundred kilometres from the site and haulage would necessarily be by truck.

Table 8-4: Cost breakdown of electricity, gas and coal

Unit	Annual Cost (US\$*10 ⁶)	% of Plant Cost
Electricity	145	36
Gas	25	6
Coal	7.5	2
Total	177.5	44

CMSA is investigating ways of reducing the cost of all three energy sources – electricity, gas and coal.

8.5.3 Sustaining Capital

Table 8-5 shows the CMSA projection for annual Sustaining Capital and Major Project Capital to 2019.

Table 8-5: Sustaining capital, 2015 to 2019 - without and with major project CAPEX

Year	2015	2016	2017	2018	2019
Baseline nickel production (lb* 10 ³)	92,700	80,600	77,500	74,900	76,000
Sustaining capital with major projects (US\$M)	40.2	25.9	24.6	10.7	12.2
(US\$/lb Ni)	0.43	0.32	0.32	0.14	0.16

The major expenditure of US\$29M on the proposed Upgrade 2 Plant installation appears in years 2016 (US\$9M) and 2017 (US\$20M), but will depend on the project gaining board approval.

8.6 Risk and opportunities

The project has been operating for 32 years and the majority of the staff and operators are experienced long-term employees. As a result, the processing operations are well understood and the metallurgical plant is operating at close to optimum levels, within the constraints of the ore feed chemistry.

The grade of the ore feed to the crusher over the coming years will be transitioning down relatively rapidly and the nickel production in ferronickel will fall proportionally. Some of the remaining higher grade ore also has higher silica content, potentially negatively impacting the furnace slag characteristics. Investigations have been ongoing for several years to assess the potential to operate the electric furnaces with a broader SiO₂: MgO range (up to a ratio of 2.2:1, compared with

the current <1.86:1) without causing operational problems. A decision on implementing the changes to slag chemistry has not yet been made.

Work has been undertaken by CMSA engineers to assess wet ore nickel upgrading by a Wobbler and Rubbler circuit that would selectively reject up to 20% of the wet ore (as hard silica-rich rocks) and achieve a 12.7% upgrade in nickel content of the dryer feed. The installation and successful operation of this circuit would achieve the two desirable aims of, 1) reducing the silica content and 2) increasing the nickel content, of the feed to the rotary kilns and electric furnaces. Realistically, such a circuit could not be installed before early 2018.

8.7 Summary comments

SRK considers that the processing plant operations at CMSA are being run by experienced and competent personnel. The most significant change currently being experienced is the relatively rapid decline in the Ni grade of the ore delivered from the mine. The relatively small amount of remaining ore in the mine has reduced the blending flexibility of the feed to the plant and changes to the electric furnace operating parameters are being assessed as a consequence. Commencing last year, stockpiled ore is now being reclaimed and blended with ore directly from the mine. Currently, the plant feed comprises about 50% from stockpiled ore and 50% from the mine. It is likely that the slag reprocessing plant will be shut permanently in early 2015, as it is not profitable to operate.

As the plant ore feed grade declines, the nickel content of the ferronickel product is also declining and by 2015 will be typically <30% Ni. Some customers have in the past expressed a preference for the nickel content to be >30% and there may be some impact on the price received.

SRK believes that operating costs and capital costs are appropriate based on an examination of site.

As the nickel production declines, the processing cost per unit of nickel will inevitably continue to increase. This is understood by management and cost reduction programs are currently under assessment or implementation as a means of countering the reduced cash flow.

9 Infrastructure

The operating philosophy for CMSA consists of own, operate and maintain its core business activities using contractors to execute major maintenance shutdown, specialised tasks and non-core activities.

The Cerro Matoso ferronickel is transported in bulker bags and containers by truck from the plant to Cartagena port. From the port, it is carried by ship to final customers.

9.1 Access

The access to and from site and to port facilities is via a sealed road. While travelling to site, it was observed that a second bridge across the St George River is being constructed. The single bridge (Figure 9-2) over this river was classed by CMSA as a risk for the continuity of concentrate transport to port. The completion date for the new bridge is not known, but should be early in 2015. It is understood that both bridges will then be utilised for general traffic.

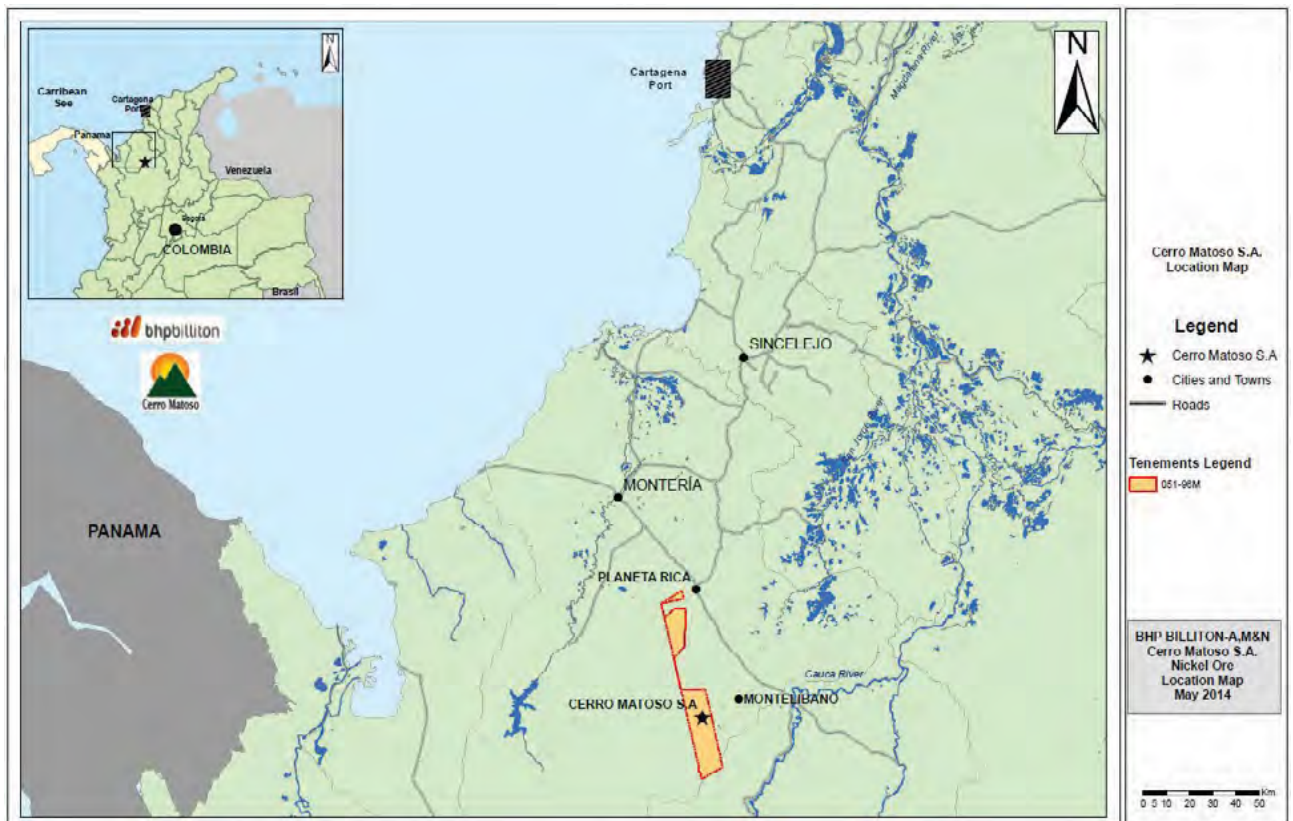

Figure 9-1: Location map showing site and port

Source: CMSA (2014)



Figure 9-2: Existing bridge over the St George River

9.2 Power

Power is supplied to site via the Colombian mains grid at a cost of US\$0.095/kwh. The risk to the continuity of supply is classed as low by CMSA.

9.3 Water

CMSA has access to pumping water from the Uré River and rain water capture in the mining operation. These two areas are the source of water supply to the site. CMSA does not have or require bore field systems installations. There are two emergency dams (near the tailings dam) for use as make-up water if required.

9.4 Communications

CMSA has good radio communications on site, supporting both voice and data requirements. Standard landline based communications off site are utilised.

9.5 Support infrastructure buildings

CMSA has an extensive on and off site infrastructure complex to maintain. On site, all supporting services have offices and are supplied with meals during shift, while off site, housing, medical services, a club, gymnasium and schooling is supplied. CMSA plans to relocate some supporting services to Monteria (or another major city), to lower the use of the relatively high cost company infrastructure and services.

CMSA currently has a good employee (and family) accessed education and medical services system. CMSA is actively looking at ways to optimise the use of these facilities.

10 Tailings Storage Facilities

10.1 Introduction

At CMSA, the raw ore is blended, dried and is then sent through an integrated pyrometallurgical process of three stages (calcination, smelting and refining). This process is followed by a granulation process and produces FeNi granules. There is no tailings from this process, but it does produce a slag product, which is stacked.

In 2007, a Metal Nickel Recovery (MNR) plant was commissioned, and the resulting tailings from this plant is stored in the La Sajana slag tailings storage facility (TSF).

10.2 TSF design

The La Sajana facility was designed for approximately 10,800 tonnes per day at a tailings solids content of 37%. The dry density of deposited tailings ranges from 1.62 (cyclone underflow) to 1.32 tonnes per cubic metre (t/m^3) (cyclone overflow). The specific gravity of the tailings solids is 2.91 and an average dry density of $1.46 t/m^3$ was used in the design. The TSF was designed to accommodate a total volume of $34 Mm^3$ of tailings. Based on the Golder 2012 closure plan (January 2012), SRK understands that 8.5 Mt of slag has been processed and deposited to the tailings facility (3,950 t Ni extracted).

The CMSA site is characterised by a moderate to high level of historical seismicity with PGAs in the range of 0.25g to 0.33g.

The fine fraction of the tailings is highly susceptible to wind transportation. Geochemically, the tailings has the same properties as the slag from which it is produced. The slag is classed as non-acid generating and chemically stable.



Figure 10-1: Layout of initial as-built facility

The La Sajana facility consists of three main compartments, namely the tailings storage facility (most northern compartment), the reclaim water dam (central compartment) and the water management dam (southern compartment) – refer Figure 10-1.

The typical cross section for the Dams is shown in Figure 10-2, and includes a drainage curtain and foundation toe drain to control the phreatic surface. The embankments were constructed using residual saprolitic soil. The embankments were compacted and an external party undertook quality control testing.

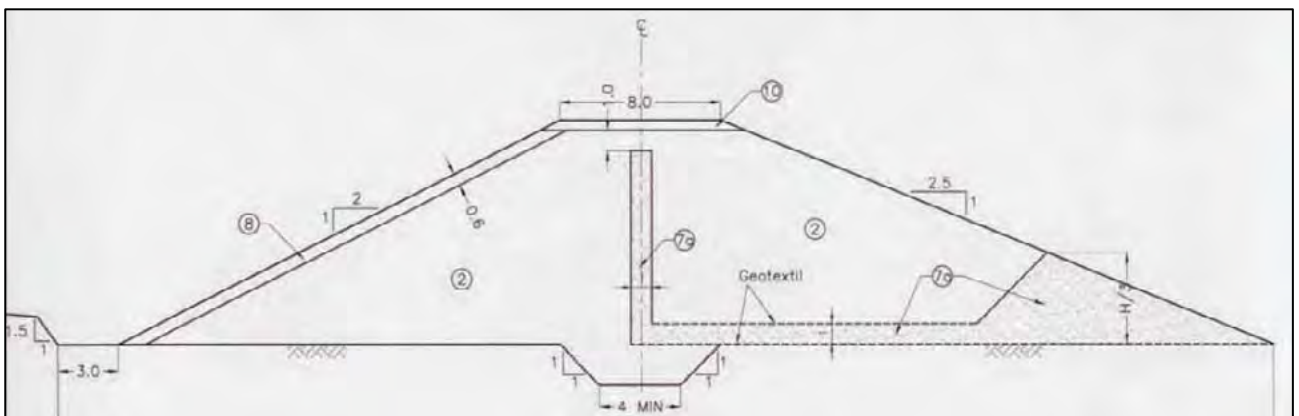

Figure 10-2: Typical dam section for tailings and water management dam

Source: CMSA (2014)

There are also minor dams downstream of the main dams to manage seepage flows from the drains. The tailings compartment has a spillway on the north side east of Dam A and there are also various connecting channels between the basins.

10.3 TSF construction and operation

The facility was originally designed as a cyclone facility, i.e. coarse cyclone underflow used to construct the containment and fine overflow deposited into the pond. However, SRK understands that the cyclone operation experienced operational problems related to the cyclones and the total slag tailings is deposited in the form of a whole slurry by spigotting.

The tailings was initially deposited from the northern side of the facility. This allowed dams A, B and C to be raised using tailings. The deposited coarse tailings on the beach is used to form the upstream raise following by relocating the spigot pipes to the raised crest. While the dams were being raised, the tailings was deposited into the south side of the facility.

CMSA has not operated the MNR plant since September 2013. The plant was restarted in October 2014 and is expected to operate until January 2015. During this time, CMSA will assess the updated operating regime and costs for the MNR, and a decision of the preferred option for the MNR plant will be made. These options include complete shutdown of the plant or continued operation.

The facility is monitored by both piezometers and inclinometers. The piezometer readings for the most recent monitoring period have been very stable, which is to be expected as no tailings deposition has been occurring. The inclinometers also indicate that there are no geotechnical issues. However, it is noted that some of the inclinometers are not fixed at the base, and these would likely need to be corrected should the facility operate further.

10.4 Closure

For the closure plan, the water elevation in the tailings facility is lowered by cutting down or lowering the spillway invert such that only a limited pond is stored on the facility.

The outer slopes would need to be regarded and vegetation. Given the dust issues from the tailings facility, it is likely that when the pond is reduced, a large portion of the upper surface would need to be vegetated as well.

10.5 Risks and opportunities

The risks associated with the La Sajana facility relate to it not being operated and therefore potentially not being monitored. SRK has identified two potential risks related to water management and fugitive dust.

If channels and spillways are not maintained and kept clean and flowing, these structures may not be able to cope with normal or design storm flows. If drains are not maintained and monitored, they may become blocked, potentially causing a rise in phreatic surface which could impact the stability of the embankments. The tailings were identified at the design stage as having dust generation potential, and it has been noted that this occurs. This fugitive dust issue is related to the dry beach, and as long as the facility is not operational and not closed, it can be expected for it to continue.

10.6 Summary comments

The facility was well constructed and the documentation is comprehensive. The facility did not operate as designed, but the modified operational raising appears to have met the storage goals. The facility is instrumented, and these have been monitored and evaluated by a third party.

This should continue until the facility is closed.

The facility is in an area of moderate to high seismicity and as such, there is always the need to be cautious in relation to the stability of the facility. If the pond is allowed to increase during closure or drains, channel or spillways become clogged, these could cause the phreatic surface to rise and ultimately fail, i.e. the facility remains a significant risk until it is closed. This fugitive dust issue is expected to continue until closure is implemented.

11 Human Resources

The CMSA operation is made up of contractors and employees. There are about 1,098 employees and just over 1,000 contractors currently engaged on site or directly supporting site activities.

As per the current conditions of employment, provision of company-supplied accommodation for staff members is at the discretion of the CMSA management. Employees that are not located in CMSA-owned camps are accommodated in the towns of Montelíbano or Puerto Libertador as per their preference.

Of CMSA's permanent employees, 73% are union members.

11.1 Forward looking strategy

The Human Resources (HR) team is focused on the strategy to set the basis of operate on a production rate of 30 ktpa. This "2020" vision relies on the ability of CMSA to achieve the following:

- Optimising labour costs
- Optimising support costs
- Involve contractors in appropriate support activities.

11.2 Industrial relations

CMSA has a collective union agreement with Sintracerrromatoso, negotiated in September 2010, which expires on 31 December 2015. CMSA plans to engage in negotiations for a new collective agreement with Sintracerrromatoso and Sintramneros (a more recently established union presence).

11.3 Recruitment

Due to the historically stable workforce and low turnover rate, recruitment has not been a critical issue. However, with the instability created by the pending demerger and current project optimisation program (2020), there is expected to be a need for recruitment of some key and support positions. CMSA is aware of this issue and has engaged the services of employment agencies.

CMSA's recruitment policy emphasises searching and recruiting first locally (Montelíbano) and also regionally (Cordoba and Costa Caribe). However, recruitment in certain specialised roles, such as; geologists, metallurgical engineers and mining engineers, is challenging. Additionally, few professionals are resident in the region and have an acceptable level of English proficiency.

11.4 Summary comments

CMSA's 2020 optimisation initiative will likely place additional workload on the HR department to recruit for key positions made vacant through natural attrition. Employment agencies are being utilised by CMSA in this event; however, employing into specialist areas is challenging.

The current agreements with Unions are due for renewal in December 2015. Significant negotiations are expected, made more difficult due to the 2020 optimisation initiative.

12 Occupational Health and Safety

12.1 OHS performance

CMSA historically has had a low incident rate; the total recordable injuries frequency (TRIF) is shown in Figure 12-1. However, it is noted that there has been a material increase in the incident rate this year.

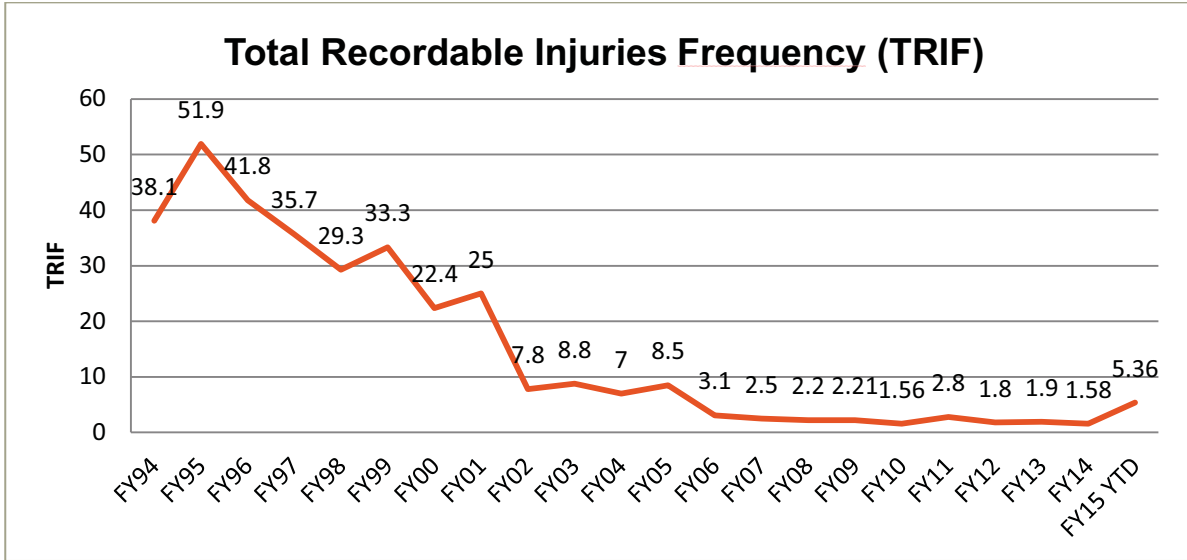

Figure 12-1: Historical incident rate

Source: CMSA (2014)

TRIF (recordable injuries per million hours worked) = (Recordable injuries x 1,000,000) ÷ exposure hours.

Recordable injuries = work-related (fatalities + lost time injuries + restricted work injuries + medical treatment injuries).

CMSA has had a declining Occupational Illness rate (Figure 12-2) since 2007. An Occupational Illness is a condition that results from exposure in a workplace to a physical, chemical or biological agent to the extent that normal physiological mechanisms are affected, and the health of the worker is impaired.

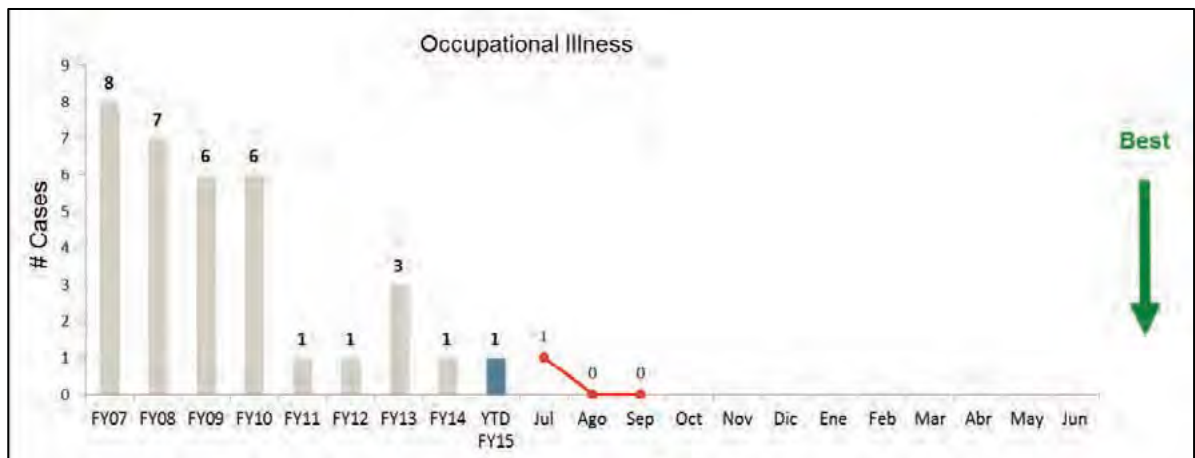

Figure 12-2: Occupational illness events

Source: CMSA (2014)

The Significant Incidents are presented in Figure 12-3. A Significant Incident is any occurrence that has actually resulted in or had a plausible potential to result in a fatality or permanent impairment (to >30% of the body) to one or more people.

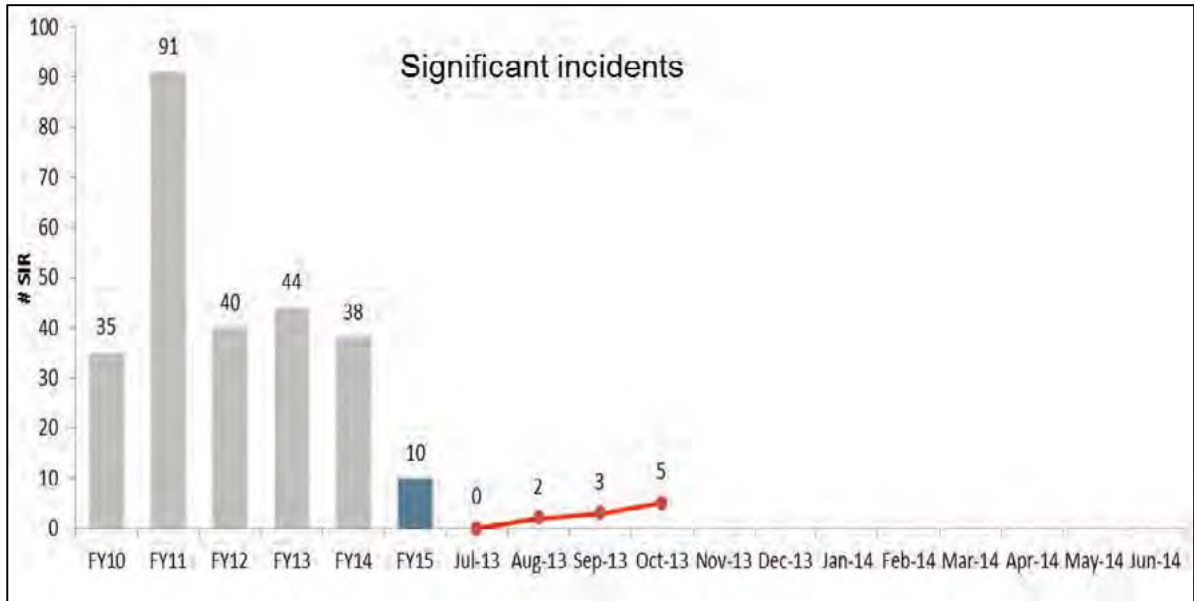

Figure 12-3: Significant incidents

12.2 Summary comments

The CMSA operation presented well in terms of operating conditions and personnel behaviour. No significant OHS issues were identified.

13 Environmental

13.1 Introduction

This report contains a review of the environmental and social aspects of the CMSA operation.

The information in this section was compiled from information collected during a site visit, along with information provided in meetings with key staff of CMSA.

13.2 Environmental setting

13.2.1 Land use

The surrounding land of the CMSA operation is mostly used for cattle raising purposes. The land is largely occupied by natural vegetation, agricultural crops and pastures.

Currently, approximately 20% of the area of the mining property of CMSA has been impacted by the development of mining activities, while the remaining 80% still has natural vegetation, which has been disturbed to a lesser extent, with activities such as the mining exploration.

13.2.2 Socio-economics

In relation to socio-economic issues, areas of direct and in direct influence have been defines. The area indirectly influenced is in the Upper San Jorge area and includes the municipalities of Montelíbano, Puerto Libertador, San José de Uré and La Apartada.

The area of direct influence includes the towns located around the CMSA operation, corresponding to Central America, La Odisea, Torno Rojo, Puente Uré, Bocas de Uré, Puerto Colombia and Pueblo Flecha. The population (directly affected) of these villages reached 3,090 in 2012 (Table 13-1).

Table 13-1: Population of CMSA's area of social influence

Area of indirect influence		Area of direct influence	
Municipality	Population (2012)	Towns	Population (2012)
Montelíbano	70,553	-	-
Puerto Libertador	34,695	Centro America	511
		La Odisea	249
		Torno Rojo	998
San Jose de Uré	10,367	Puente ure	138
		Bocas de Uré	514
		Puerto Colombia	224
		Pueblo Flecha	456
La Apartada	11,926	-	-

Source: Plan de Manejo Ambiental Unificado, Proyecto de Explotación y Beneficio de Ferroniquel. Cerro Matoso, January 2014

In the area of direct influence, most of the families of these communities have been recognised by the Colombian government as indigenous people.

13.2.3 Climate

The Cerro Matoso mine is located in a tropical environment, with an annual rainfall of ~2,360 mm. The rainy season is between May and October, the driest months are from December to March and the months of April and November are considered transitional. The relative humidity varies between 83% and 87%, the average temperature is 27°C, and the prevailing wind direction is west–south west.

13.2.4 Surface Water

The CMSA operation is located in the Uré River basin. The waters of the Uré River run from south to north through areas of low topography. The basin has an area of approximately 484 km² before its confluence with the San Jorge River. Several small unnamed creeks also drain into the Uré River from southern and western sides of the CMSA property and north east from the northern boundary of the property. The river turns east to its confluence with the San Jorge River at a point near Bocas de Uré about 6 km north east of the Cerro Matos property. The San Jorge River finally discharges into the Magdalena River, which flows towards the Caribbean Sea.

The El Tigre Creek drainage basin is 31.4 km², approximately 70% to 80% of which is upstream of the mine site. Historical flow data for El Tigre Creek shows the minimum is 0.30 m³/s, the average is 1.41 m³/s and the maximum monthly flow is 3.31 m³/s.

13.2.5 Hydrogeology

The water table at the mine and within the Uré River and the El Tigre Creek basins mirrors the surface topography. The regional groundwater flows in a north easterly direction towards the San Jorge River. A detailed hydrogeological study and mathematical model was developed by Aguas Subterráneas Ltda. (2009). Based on this hydrogeological analysis, a percolation rate of 115,7 mm/year for the area was estimated. Three hydrostratigraphic units was identified for the area: an unconfined, consisting of clays with interbedded fine-grained sandstone, with very low to medium specific capacity; an alluvial aquifer consisting in of alluvial sediments and fluvial terraces; and an aquiclude consisting of clay and ultramafic rocks, which do not store or transmit groundwater unless through their fractures, due to their low porosity and hydraulic conductivity.

13.2.6 Biodiversity

The site is located within the humid tropical forest zone of the Choco-Magdalena biogeographic zone; comprising eight natural vegetation communities predominated by grasslands. Habitat degradation, not related to mining, and hunting have resulted in population declines.

13.3 Environmental Permitting and Compliance

13.3.1 Required Permits and Status

Environmental Permits

For the development of industrial mining activity, CMSA has an environmental license granted by the Regional Autonomous Corporation of the valleys of the Sinu and San Jorge (*Corporación Autónoma Regional de los valles del Sinu and San Jorge - CVS*), through Resolution 224 of 30 September 1981. The license was amended by the Ministry of Environment and Sustainable Development (*Ministerio de Medio Ambiente y Desarrollo Sostenible - MADS*), adding to the mining project, the activities of Metal Nickel Recovery (MNR Project) and Optimizing Fuel Burners (QQC Project), by resolutions 1609 of 11 August 2006 and 664 as of 31 March 2010 respectively.

Additionally, on 24 August 1998, CMSA filed the Environmental Assessment and Management Document (*Documento de Evaluación y Manejo Ambiental - DEMA*), in accordance with the standards established by Decree 883 of 1997 with the environmental authority. Given the type of environmental license held, CMSA has been processed through the regional environmental authority (CVS), the applicable environmental permits for the operation.

On 15 July 2013, the National Environmental Licenses Authority (*Autoridad Nacional de Licencias Ambientales - ANLA*) requested CMSA to update and unify the environmental management plans in place for all activities of the company under the environmental license and amendments. The document requested was submitted by CMSA on January 2014.

Environmental licenses that have been granted to CMSA are presented in Table 13-1. The geographical area that includes the granted licenses is shown in Figure 13-1.

Table 13-2: Environmental Licenses of CMSA

Permit	Legal Reference	Period	Description	Status
Environmental License	Resolution 224, Sept 1981	Useful life of the project	Original license, previous to the Colombian environmental legislation	In place, have passed several modifications
Modification to the environmental license	Resolution 1609, August 2006	Useful life of the project	Modification of the 1981 original license Include nickel recovery from slag (MNR Plant and La Sajana deposit)	In place
Modification to the environmental license	Resolution 621, March 2009	Useful life of the project	Modification of Resolution 1609, including forestry compensation measures	In place
Modification to the environmental license	Resolution 664, March 2010	Useful life of the project	Modification of Resolution 224, including activity of optimisation of fuel burners	Project has not been executed
Modification to the environmental license	Resolution 684, July 2013	Useful life of the project	Modification of Resolution 224, including the recovery of low grade nickel from lateritic minerals by means of an hydrometallurgical process (Leaching Plant Project)	Project has not been executed
Modification to the environmental license	Resolution 015, February 2014	Useful life of the project	Modification of Resolution 684, in order to modify and revoke some obligations set forth	In place
Modification to the environmental license	Resolution 2118, October 2010	Useful life of the project ¹	New License for the construction and Operation of a Coal power plant and grid, outside the project area	Project had not been executed

Source: 02.03.10.03 IM Cerro Matoso 95 Environmental Permits

¹ The environmental license can expire if the project not initiated in a period of five years.

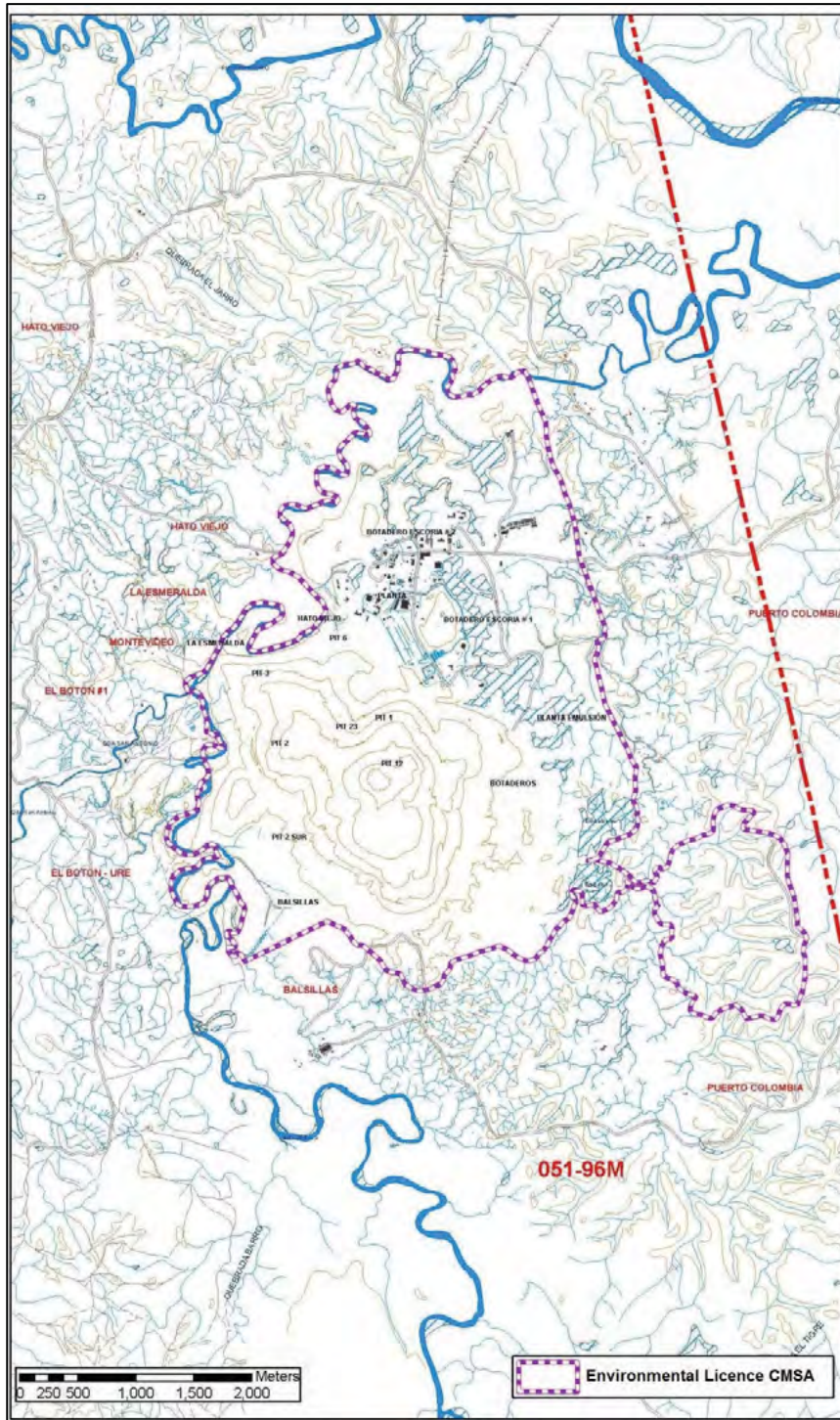

Figure 13-1: Area of Environmental Licenses

Source: CMSA (2014)

For Esmeralda project, CMSA developed an environmental and social impact assessment (ESIA) under Colombian regulations in March 2011, requesting a modification of the environmental license to include mining operations in this new area. However, due to the terms and conditions established in the Amendment to Contract 051-96M (OtroSI N° 4), negotiated with Colombian mining authority to extend the current mining concession, the Colombian environmental authority has informed CMSA that a new Environmental License will be required to start mining activities in the Esmeralda area.

This means that the Esmeralda Open Pit project, require a new Environmental License together with a new Mining Work Program (Programa de Trabajo y Obras - PTO).

An ESIA for Esmeralda Project is under development. Due to the presence of indigenous communities in the project influence area, it is necessary to develop a process of Public Consultation, seeking the consent of communities to achieve an agreement.

Indigenous communities in the area of influence involve the town of Puente Uré, with a population of about 138 people, and the town of Centro America, with a population of about 511 people.

A meeting schedule was established, which has been fulfilled with the Puente Uré community, and it is expected that an agreement with this community will be finalised by January 2015. Engagement with the Centro America community is ongoing.

The communities do not have a right to veto a proposal; therefore, if there is no agreement from Centro America to meet the required schedule, it is possible to request the intervention of the central government. However, CMSA does not want to reach this stage and hopes to be able to reach an agreement with the Centro America indigenous community.

Although the government can be involved, there are risks of legal demands and social protests by communities, such as occurred in 2012 and 2013. CMSA recognises that the best scenario for the project is to achieve an agreement with the community. CMSA has a strong team in place to address these issues.

The submittal of the ESIA can be only take place after the finalisation of the consultation process, and the achieving of an agreement with the community. The evaluation process of an ESIA can then take one year.

Natural resources use

In addition to the environmental licenses, there are a number of other permits related to the use of natural resources, water discharge and water extraction concessions. These permits have been granted and have been updated as required. These permits are presented in Appendix B (Table B-1).

13.4 Environmental and Social Management and Monitoring

Given the characteristics of the operation and its location, the relevant environmental management issues are related to; water and sediment management, biodiversity management, air emissions management and relations with indigenous communities in the area of influence of the operation.

CMSA has an Environmental Management System certified to ISO 14,001, since 2001.

There is an Environmental Management Plan updated to January 2014, which meets all environmental legal compliance and the environmental measures committed in the CMSA environmental licenses. This plan was submitted to the environmental authority (ANLA), which audits the operation as minimum once a year.

Furthermore, CMSA is required to submit an annual Environmental Compliance Report (*Informe de Cumplimiento Ambiental - ICA*). These reports are reviewed in detail by the environmental authority, which makes observations and may require additional activities or measures, which should be reported in the next annual ICA.

The following sections contain a description of the relevant issues of the project's environmental and social management. Information for this section was complemented with the review of the last ICA (August 2014), and the legal documentation containing the comments of the authorities to the ICA (ANLA, 2014a y 2014b).

13.4.1 Water Management

Operations water is reclaimed and only a small percentage of make-up water is pumped from Ure River, under the available water extraction permits. Any effluent reports predominately to El Tigre Creek to the east of the property via a system of three storage reservoirs (1, 2 and 3).

La Sajana slag tailing ponds controls all the water from the slag dump facility, effluent and runoff. The water is pumped to the water supply ponds. The spill water located to the east of the facility discharges to El Tigre Creek.

A perimeter channel surrounds the mine waste overburden dump to collect surface runoff and to intercept sediment eroded from the active mine and dump, and it discharges into a Sedimentation Pond. The Sedimentation Pond outflows report to reservoir N° 3.

A series of ditches has been constructed on the mine waste overburden dump to collect storm water runoff and to aid sediment management. These flows report to the perimeter channel and to reservoir N°2.

Slag granulation water is discharge into a stilling basin that drains through a canal into reservoir N°3.

Cooling water from the ferronickel pellets granulation process flows in a pipe under the plant area and then through a ditch located behind the office building that also discharges into reservoir N° 2.

Shallow unlined trenches constructed at various locations around the plant facilities intercept surface water runoff originated in the plan area. Water collected in the trenches discharges into unlined drainage canals which convey water away from the plant site to the Ure River via Tornoroto Creek.

To control water quality, CMSA has a surface and groundwater monitoring.

CMSA has a monitoring network consisting in 29 surface water monitoring points. Single samples are taken every three months in all seasons and composite samples area taken monthly for the main domestic and Industrial effluents, and composite samples area taken every six months at most of the surface water and effluent sampling locations.

Groundwater is measured in 10 points every six months.

The results of the monitoring program, taken from the reports of Golder (2012a), ACON (2014b), CMSA. (2014a) and from the authorities' documentation (ANLA, 2014a and 2014b), indicate that although certain metal concentrations in the site effluent exceeded Colombian guidelines at times and there currently does not appear to have been any distinguishable water quality impacts in either Ure River or El Tigre Creek downstream of CMSA operations.

13.4.2 Air quality

An air quality monitoring program is in place for particulate matter and gases.

Isokinetic sampling is performed in 15 locations, for particulate matter and SO_x and NO_x in the Leaching Pilot Plant boiler.

In all plant operational areas, there are emission control devices, such as filters and electrostatic precipitator. Dust on roads and waste dumps are controlled through water sprays.

In 2010 (Resolution 1.4099), the Conversion Plan to Clean Technologies for the electric furnaces of productions lines 1 and 2 was approved, which involves the replacement of the scrubber system. Line 1 is now in operation, and Line 2 is committed for completion by December 2015.

Communities located around the operation, are the air quality sensitive receptors. An air quality monitoring network is maintained in the close to surrounding communities, where PM₁₀, NO_x and SO₂ are monitored.

Based on a historical analysis of the monitoring data (six years), according with ACON (2014b), CMSA (2014a) and according the authorities documentation (ANLA, 2014a and 2014b), the air quality concentrations are under the permissible limits, without causing health hazards to nearby residents. Concentrations do increase in dry periods, but remain under the applicable standards.

However, there have been some complaints from the communities of Puerto Colombia and Pueblo Flecha for dust emissions coming from site vehicle traffic and from La Sajana area during high wind periods. This apparently was related to a specific event that occurred in August 2011.

In order to determine the efficiency of the dust control measures, especially in dry period, the authorities request to CMSA in October 2014 to carry out a specific study, including a meteorological analysis, new monitoring and chemical analysis of filters.

13.4.3 Biodiversity

Environmental biodiversity commitments for CMSA are mainly related to ongoing re-vegetation of the waste and slag dumps, based on the results of the ecological survey applied by CMSA. The areas to be re-vegetated are planned annually, according to the production schedules.

Up until 2013, the La Sajana deposit, has re-vegetated 26.45 ha. An area of 22.53 ha of mine waste dumps has been re-vegetated.

Additionally, there is a compensatory forestry requirement of 98 ha in areas adjacent to the mining operation. Up until 2013, a total of 60.36 ha has been forested.

13.4.4 Socio-economic

There are indigenous communities in the areas surrounding the CMSA operation, which are highly vulnerable from a socio-economic point of view. In recent years, there has been a growing empowerment of communities.

Following the approval of the Otrosí N° 4 Contract 056-96M, which allows the potential extension of mine life up until 2044, questions were raised regarding the contract's legality and the social and environmental performance of the company.

Some communities in the area of influence claimed that the CMSA operations had affected their health and their environment, filing a lawsuit that is still ongoing. Pueblo Flecha community questioned the effectiveness of the social investment by the company, given the poverty of the communities in the area of influence. As part of the social debate, there was a protest by the indigenous group, Zenu, on roads leading to the processing plant, which resulted in the suspension of operations during September and October 2013.

CMSA has presented evidence demonstrating that illnesses reported by the population have no connection with the operation. However, CMSA has committed to fund an epidemiological study in the area, which will be conducted by the Pan American Health Organisation (PAHO).

CMSA has had a social program in place since start-up. After the events of 2012-2013, CMSA has carried out a critical review of its management of social issues and created a more focused management of communities and indigenous groups. Previously, social issues were under the Health, Safety, Environment & Community (HSEC) department.

International Labour Organisation (ILO) 169 Indigenous and Tribal Peoples Convention (1989) established the concept of "Free, Prior and Informed Consent" that refers to the right, particularly of indigenous communities, to participate in decision making about issues that will affect them. This convention was ratified by Colombia. Under this principle, any project having indigenous communities within its area of influence area, should obtain the community consent for any new development.

Colombian laws have regulated this process; and CMSA is required to secure a pre-agreement with the communities.

The relationship of CMSA with the surrounding indigenous communities will be a key issue in the development of the project, and social investment will need to be a real to support ongoing operations. In 2012, as part of the renegotiation of the Otrosí N° 4, CMSA committed to the following:

- Make a social investment in the Upper San Jorge equivalent to 1% of annual profits before tax, with a minimum guaranteed of US\$2,5M per year; and
- Invest US\$10M, during the first four years (until December 2016), in high impact projects or social programs, consistent with the development plans adopted by municipalities in the area of direct influence.

The social investment is carried out through the Community Development Plan operated by the Cerro Matoso Foundation. In 2013, social investment was ~US\$3.7M.

To address the social investment of CMSA in the four municipalities of Alto San Jorge, an Alliance was signed with the Department for Social Prosperity (DPS), a state agency dedicated to social issues.

13.5 Closure Plan and Costs

According to the provisions of the mining concession contract, CMSA is required to adequately plan for closure.

CMSA has a progressive closure plan and a final closure plan. The progressive closure plan is carried out during project operation, in 2013 - 2029 (and possibly until 2044 as established in Otrosí N° 4 of Contract 051-96M) and the final closure is considered between years 2029 and 2034 (5 years). The costs of the progressive closure plan are considered part of the operation costs.

The closure costs presented in this section are those included in the document "Actualización Plan de Cierre Cerro Matoso S.A." developed by ACON in October 2014, and are based in a document prepared by Golder Associates in 2012. The estimated costs of the final closure plan are US\$161M (Table 13-3). The costs are updated every three years by CMSA. The basis of the cost estimation and main closure activities are the following:

- Costs of demolition have been prepared using the unit prices and labor costs adopted from the MNR project and demolition of the furnace of Line 1 in 2011.
- Re-vegetation costs: Costs associated with re-vegetation were calculated taking into account the costs of labour, materials, machinery and equipment, required for recovery with enhanced soil, or as re-vegetation with grass.
- Open pit closure costs: Closure costs associated with the open pit are related with previous studies (slope stability and hydrological study), as well as civil works required for erosion control, fencing off the area and final re-vegetation of disturbed areas.
- Costs associated with the closure of the mine deposit and slag deposits: Closure costs associated with waste rock and Cerro Matoso slag deposits are mainly due to civil works for the management of runoff and slope adjustment required in these areas; the costs associated with final re-vegetation of these areas are also included.
- Costs associated with the management of water in the reservoirs: The estimated costs associated with the management of water in the reservoirs were calculated taking into account the civil works required for the adaptation and final closure of reservoirs. These works include rupture of the dykes to create wetlands, re-vegetation of the canals and reservoir shores as well as dredging of the reservoirs.

- Cost of residual risk: These costs were estimated from a residual risk identification performed in a workshop "Range Analysis" held with staff from different business units of CMSA.
- Community cost: Related to social spending considered in the Cerro Matoso Management Plan and instability in the region for unemployment generated by closure.
- Cost Control and Environmental Monitoring: Considers post-closure inspection and maintenance costs.
- Biological resource evaluation costs: Post-closure monitoring costs associated with studies conducted five years after closing.

Table 13-3: Closure cost estimation by facility

Description	Total costs (US\$ 12/Nov/2014)
Civil works: Mobilisation/Demobilisation	360,017
Open Pit	5,885,622
Mine and slag deposits	12,199,122
Processing plant installations	68,314,055
Water management	2,198,755
Pumps and pipes	58,502
Treatment plants (incl. pumps and pipes)	71,459
Landfill	55,294
Subtotal (A)	89,142,830
Community	6,723,413
Environmental control and monitoring	6,624,540
Evaluation of aquatic and land biological resources (5 years after closure)	49,502
Subtotal (B)	13,397,455
Indirect recruitment (15% of direct costs)	15,381,043
Design, procurement and construction administration (17% of direct costs)	17,431,848
Contingency (25% of direct costs)	25,635,071
Subtotal (C)	58,447,963
Total (B+C)	160,988,248

Source: ACON, 2014. Actualización Plan de Cierre Cerro Matoso S.A.

The ACON 2014 closure cost includes the employee compensation cost (US\$29M), that are treated as an operating cost.

The criteria and basis for estimating the costs associated with closure are as follows:

- Class 4 Estimation - Equipment Factor Estimate (BHP Billiton , 20011b), which is used when the time remaining in the closure is over 5 years and considers a range of accuracy of $\pm 25 - 30\%$ for the conceptual design.
- Costs are calculated in US dollars according to the exchange rate for 2014.
- Unit rates used have variable accuracies due to the large excavation volumes and the need for both natural and processed materials from various sources.
- The cost estimate has been developed taking into account the conceptual designs for the works to be carried out at the end of the life of the mining project, and does not include taxes.

A number of further studies will be required in time to update this closure cost estimate to a higher level of accuracy.

Closure Plan provision

Under current Colombian legislation, mining companies are not required to maintain a bond for closure. CMSA has estimated a provision of US\$161M for 2015. This cost does not include the cost of employee compensation.

13.6 Summary comments

13.6.1 Environmental and Social

- SRK review has identified that CMSA has exploration and exploitation rights in an area of 52,850 ha, which will expire in 2029, although it is possible to apply for an extension. The concession can be extended to 2044 if the company increases the dry ore processing capability from 3.0 Mtpa up to 4.5 Mtpa, within a 10-year period of the formalisation of the contract amendment (2012).
- In relation to relevant environmental licenses for the mining operation, SRK's review showed that CMSA has these licenses in place; the licenses are being regularly updated, as required.
- The Esmeralda Project is pending on account of environmental licensing. Currently, the Project is in process of public consultation with two communities. In the case of one of the communities, involved in the consultation, discussions have been difficult, and the achievement of an agreement looks uncertain. A competent negotiation team is in place to support an outcome, and if no agreement is achieved, it is possible that the government will intervene in order to continue the licensing process for the project (because communities do not have rights of veto). However, this in itself does not guarantee an outcome. Considering this, SRK's opinion is that the environmental license for Esmeralda Project could take longer than projected; there is even some uncertainty about a final environmental approval for the Project.
- In relation to environmental management, SRK is of the opinion that the operation has a comprehensive Environmental Management Plan, including good environmental practices, legal compliance and all commitments required for the licensing and permitting process. The plan includes specific management and monitoring of relevant issues such as; water, air, wastes, biodiversity and soil.
- In relation to environmental performance, there have been some complaints from nearby communities regarding air quality and impact on health, and CMSA has committed to undertake specific studies in this regard. However, historical results of water and air quality monitoring indicate that potential concentrations are under the permissible limits, without causing health hazards to nearby residents.
- In relation with social issues, SRK's opinion is that relations with the nearby communities will be a key issue to support the LOMP of future CMSA operations and social investment will need to be an important focus during the operation. In this regard, SRK considers that actions undertaken since the "community crisis" of 2012, which include the creation of the VP of External Affairs and focus on communities and indigenous groups, is a proactive attitude.

13.6.2 Closure

The operation has a closure plan that is updated every three years, in compliance with BHP Billiton standards and also in compliance with Colombian legislation and Mining Concession Contract.

The costs of the final closure plan are US\$160,988,252, which includes fixed costs, indirect costs (32% of direct costs) and contingencies (25% of direct cost). Progressive costs are part of the operation costs.

SRK believes that the estimated closure costs consider all the proper activities and measures that result from the risk assessment. The most representative activities in the costs are the decommissioning of processing plant facilities (66% of the direct cost, and 42% of the final closure cost).

CMSA has estimated (for 2015) a provision of US\$161M.

The cost estimation available was defined as Class 4 standards (accuracy of $\pm 25\%$ - 30% for conceptual design). As the time of project closure approaches, the cost estimate will need to be progressively refined to meet a higher class standard. A number of further studies will be required for this purpose.

14 Valuation – Methodology

14.1 Introduction

SRK has undertaken an economic analysis and valuation of the Cerro Matoso Ore Reserves. SRK has adopted the discounted cash flow (DCF) valuation method to determine the Project's NPV, and subsequently, a range of values for this project. This section of the report summarises SRK assumptions and conclusions.

14.2 Reporting standard

This section of the Report has been prepared to the standard of, and is considered by SRK to be a Valuation Report under the guidelines of the VALMIN Code.

The VALMIN Code is the code adopted by The Australasian Institute of Mining and Metallurgy (AusIMM) and the standard is binding upon all AusIMM members. The VALMIN Code incorporates the JORC Code for the reporting of Mineral Resources and Ore Reserves.

The effective date of this Technical Valuation of Reserves is deemed to be 31 December 2014.

SRK has valued the Project on the basis of Technical Value of the Ore Reserve. The "Technical Value" is defined in the VALMIN Code (2005) as shown below:

Clause D36 of the VALMIN (2005) Code: Technical Value is an assessment of a Mineral or Petroleum Asset's future net economic benefit at the Valuation Date under a set of assumptions deemed most appropriate by an Expert or Specialist, excluding any premium or discount to account for such factors as market or strategic considerations.

14.3 Valuation Method

Most mineral assets can be classified as either:

- **Exploration Property:** properties where mineralisation may or may not have been identified, but where a Mineral Resource has not been identified;
- **Advanced Exploration Property:** properties where considerable exploration has been undertaken and specific targets have been identified that warrant further detailed evaluation, usually by drill testing, trenching or some other form of detailed geological sampling. A Mineral Resource estimate may or may not have been made, but sufficient work will have been undertaken on at least one prospect to provide both a good understanding of the type of mineralisation present and encouragement that further work will elevate one or more of the prospects to the resource category;
- **Pre-Development Property:** properties where Mineral Resources have been identified and their extent estimated (possibly incompletely) but where a decision to proceed with development has not been made. Properties at the early assessment stage, properties for which a decision has been made not to proceed with development, properties on care and maintenance and properties held on retention titles are included in this category if Mineral Resources have been identified, even if no further Valuation, Technical Assessment, delineation or advanced exploration is being undertaken;
- **Development Property:** properties for which a decision has been made to proceed with construction and/or production, but which are not yet commissioned or are not yet operating at design levels; and
- **Operating Mines:** mineral properties, particularly mines and processing plants that have been commissioned and are in production.

14.4 Materiality

Consideration of materiality as defined within the VALMIN Code 2005 refers to: (a) the contents and conclusions of the CPR; (b) any contributing assessment, calculation or the like; and (c) data and information; are of such importance that their inclusion or omission from a technical assessment or valuation may result in a reader of the CPR reaching a different conclusion than would otherwise be the case.

The determination of what is material depends on both qualitative and quantitative factors. Something may be material in the qualitative sense because of its very nature, such as, for example, country risk. In the case of quantitative issues in this CPR, the materiality of data has been assessed in terms of the extent to which the omission or inclusion of an item could lead to changes in total value of: less than five per cent where the item is generally not material; between five and ten per cent where the item may be material; and more than ten percent where the item is definitely material.

14.5 Summary comments

SRK considers the property development status to be that of an Operating Mine level. Accordingly SRK has decided on the Income Based Approach and specifically the DCF methodology as its valuation method. The project has declared Reserves therefore SRK believes that DCF is the appropriate methodology with which to undertake the valuation, as DCF takes into account the information unique to the deposit.

SRK has also undertaken a research on comparable transactions as a reference to the DCF valuation.

15 Valuation – Value

15.1 Commodity prices & Macro-economics

15.1.1 Introduction

The following section includes historical and forecast statistics to support the principal assumptions regarding commodity prices and macro-economic inputs into the Technical Value of the Ore Reserve for CMSA. The information as presented herein has been sourced from various public domain information databases including internet sources.

The following section is presented for information only and should not be considered a substitute for a detailed historical and forecast demand-supply-price analysis in respect of commodity prices and economic analysis nor that analysis typically required to support forecast assumptions with respect to exchange rates and consumer price inflation.

15.1.2 Commodity price

The Company has not specifically commissioned an independent commodity market specialist to provide a detailed Ni demand-supply-price analysis. Accordingly SRK has relied upon consensus market forecasts for the short term (less than five years) annual and LTP projections. These are derived from the median of brokers' equity research forecasts and are reported in real terms as at 15 October 2014.

The consensus market forecast (CMF) databases accessed by SRK provide price forecasts for the next three calendar years and a LTP for all periods beyond Year 5. In this instance and where appropriate, SRK has made various adjustments to the CMF, specifically when extrapolating the three year forecast to the LTP.

Table 15-1: Consensus market forecasts

Commodity	Units	Spot price 14/11/2014	2015	2016	2017	2018	2019	LTP
Nickel	US\$/t	15,516	20,700	19,400	19,500	20,300	19,400	19,700
	US\$/lb	7.04	9.39	8.80	8.85	9.21	8.80	8.94

Figure 15-1 presents the range of consensus forecasts. In its valuation of CMSA, SRK has adopted a price forecasts at the lower end of consensus of US\$7.90/lb.

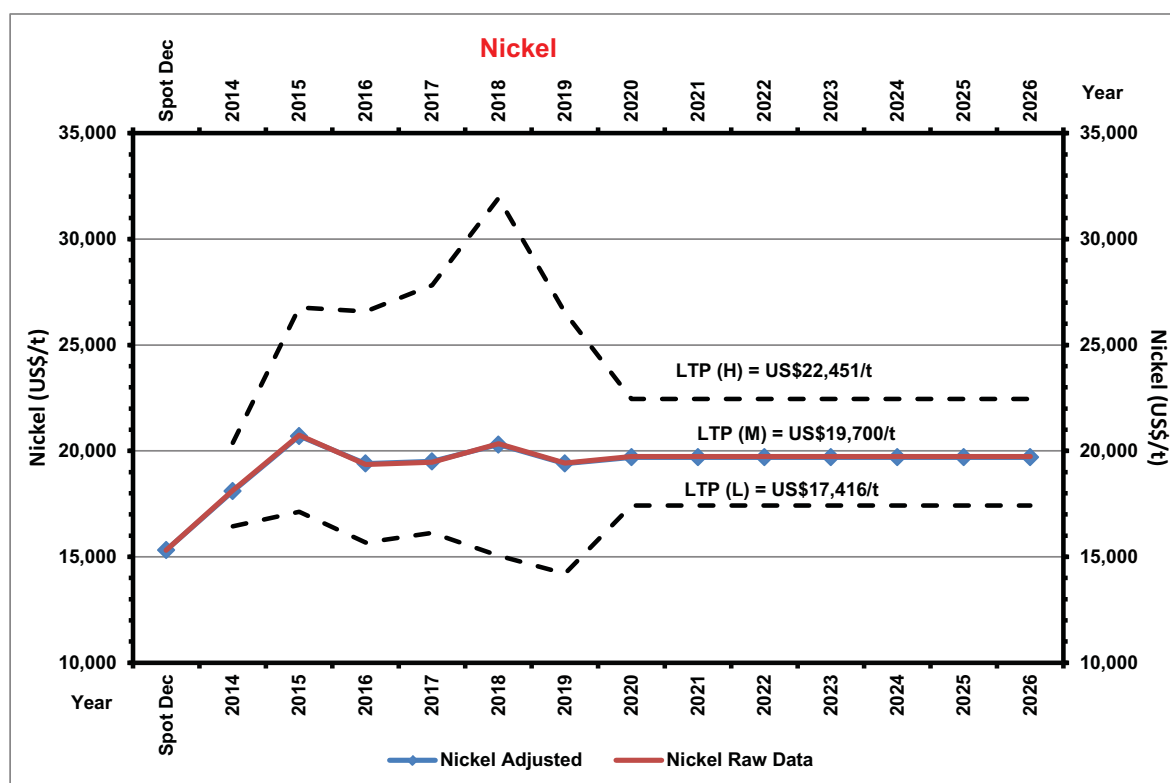

Figure 15-1: Consensus nickel price forecast

15.1.3 Macro-economics

Recent and current market conditions

During 2011, LME cash nickel prices and stocks both decreased. Prices remained low, at about half the peak price from 2007. During 2012, nickel stocks increased. Moderate price fluctuations occurred throughout 2012: prices peaked early in the year, associated with stabilisation of the base metals market and improved investor sentiment, and continued demand from China. Despite the price increases early in the year, the average nickel price for 2012 decreased relative to 2011.

Nickel stocks continued to increase during 2013, reaching a record high. Despite a continued decline in price, nickel pig iron (NPI) production continued to increase, particularly in China. Limited fluctuation of nickel price during the second half of 2013 caused some to predict that a bottom may have been reached.

In January 2014, an Indonesian ban on exports of unprocessed nickel ore came into effect. Prices consequently increased substantially during the first half of 2014. NPI producers in China increased stockpiling in anticipation of the ban, leading to predictions that the effects of supply restriction would not be significant in 2014. Since peaking in May 2014, prices have reduced significantly; investment bank predictions of the average price for 2014 are variable, but typically predict that the average price for the year will decrease slightly relative to the average price in 2013.

In addition to greater stockpiling by NPI producers in China, increased exports of medium grade nickel ore from the Philippines have partially offset the loss of Indonesian exports. Surplus supply is still anticipated for 2014; however, a deficit may occur in 2015-2016, with the potential to continue for several years. Three new mines began production in 2013, and only one new mine was scheduled to begin production in 2014. The extent of surplus or deficit is sensitive to the timing of new NPI production capacity that is planned to come online between 2015 and 2019, in Indonesia and China. New NPI production capacity in Indonesia is unlikely to be significant before 2019, due to extended permitting processes, time for construction, and sourcing of skilled labour.

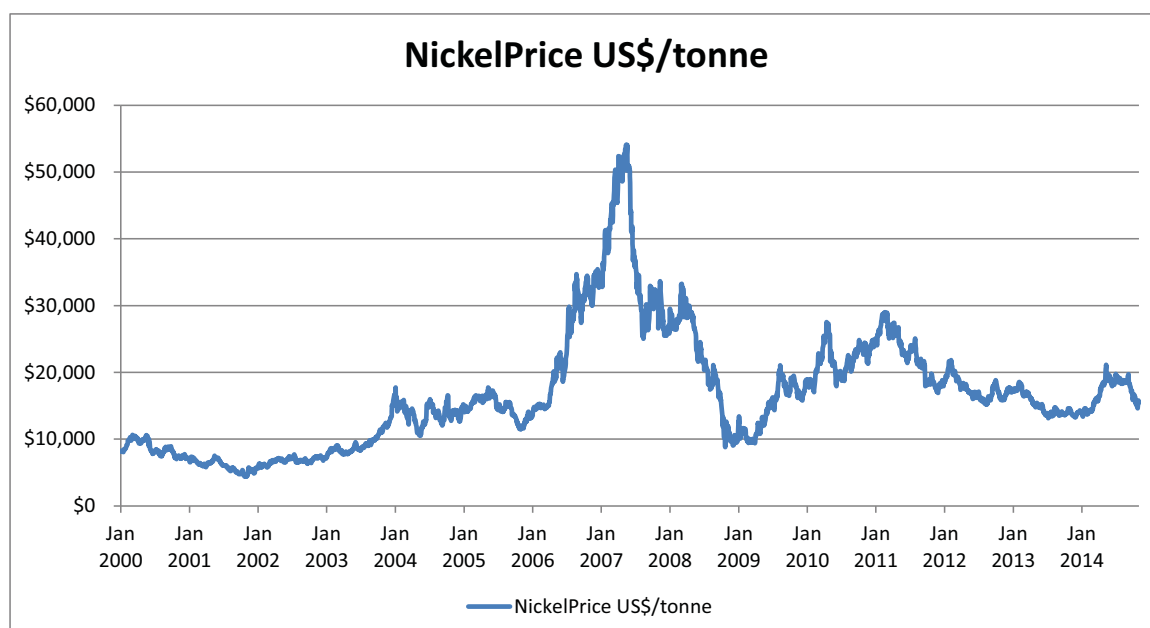

Figure 15-2: Historical nickel price

Supply issues

In 2013 three new mines began production: (1) Glencore-Xstrata began production at Koniambo mine in New Caledonia; (2) Vale re-opened Totten mine in Sudbury, Canada; and (3) Mwana Africa/Bindura Nickel opened Trojan mine in Zimbabwe. In 2014, only one new mine was scheduled to begin production, Jilin Jien Nickel's Nunavik mine in Quebec, Canada. Few new nickel mines are expected to begin production until at least 2016.

Indonesia introduced a 100% ban on unprocessed nickel ore exports which came into effect in January 2014. Although Chinese NPI producers increased imports from Indonesia in order to build up stocks in anticipation of the ban, stocks were expected to be depleted by October 2014. Stocks have not yet been exhausted; however, as increased exports of medium grade nickel ore from the Philippines have enabled continued production using a blend of high grade ore from Indonesia and medium grade ore from the Philippines. In mid-2014, a Philippines senator proposed a bill to introduce a similar ban to nickel ore exports; however, the level of political support for the ban, and the time that would be required to legislate and implement the ban, is uncertain.

The increasing surplus from 2013 reduced in 2014, and a deficit may occur as early as 2015-2016. Despite continued low prices, NPI production in China continued to increase in 2014, and new plants using more energy efficient rotary kiln electric furnace technology are planned to begin operation over the next several years.

Reports suggest that progress in building new NPI production plants in Indonesia is slow, and that very little production capacity will be available before late 2015. Predictions of NPI production capacity in Indonesia up to 2019 are highly variable.

Demand issues

Global demand is sensitive to China's economic growth and stainless steel production. Credit restrictions in China are leading to reductions in orders for stainless steel. Despite these restrictions, global steel production still increased in 2013, and China accounted for about half of world's nickel consumption for the year.

Supply/ demand balance effect on price

Forecast growth in China's economy expected to be matched by increased supply. NPI production in China is reducing gradually, associated with decreased steel orders and shutdown of some plants

in Inner Mongolia over environmental restrictions, but production is still increased relative to early forecasts for 2014.

The credit restrictions in China have prevented some NPI producers from stockpiling medium grade nickel ore from the Philippines.

In October 2014, a new government took office in Indonesia. If the new Government were to remove the ban on Indonesian nickel exports then an increase global supply could lead to lower prices. However, it is likely that the ban will remain in place. The supply/ demand balance is likely to be sensitive to the timing of new NPI production capacity that is planned in Indonesia.

15.2 Financial model structure and Inputs

15.2.1 Introduction

SRK has used the Income Based Approach and DCF methodology to determine the Technical Value of the Ore Reserve for CMSA. SRK has developed a financial model (the **Financial Model**) derived from the base case financial model (developed by BHP Billiton) and where appropriate, including various adjustments to the forecasted production, operating expenditure and capital expenditure line items.

SRK has relied upon certain financial information provided by BHP Billiton inclusive of that included in public domain reporting as well as management accounts. Furthermore, in preparing the Financial Model, and consequently deriving the Technical Value of the Ore Reserve for CMSA, SRK has relied on various inputs, the nature of and underlying rationale for which is discussed below.

15.2.2 Model assumptions

- The Working Capital assumptions included in the model are 30 days for both debtors and creditors.
- Depreciation has been calculated using a 10% Straight Line method.
- Royalty revenue has been calculated on 101.6% of the applicable LME price; the royalty formula used was revenue (minus 75% of applicable costs) multiplied by 13%.
- A Corporate Tax Rate of 25% was used in after tax cash flow (ATCF) calculations.
- A flat foreign exchange rate of COP/US\$ 1,900 has been used.
- Table 15-2 shows the calculations used to determine the Nominal Discount Rate of 13.61% used in the valuation.

Table 15-2: Discount rate calculation

Colombian Risk Free Rate	5.00%
Market Risk Premium	7.91%
Beta	1.5
Cost of Equity	16.87%
Debt Margin	3.00%
Cost of Debt	8.00%
Project Tax Rate	25.00%
Post-tax cost of debt	6.00%
Target Debt Equity Ration [D/D+E]]	30.00%
WACC - Nominal	13.61%
Colombia Inflation Rate	3.00%
WACC in Real terms	10.30%

15.3 Financial model results

Table 15-3 outlines the inputs and outputs of the Financial Model and shows production, grades, operating costs, capital costs, revenue, taxes & royalties and ATCF. Figure 15-3 to Figure 15-9 to show the Financial Model inputs and outputs graphically.

Table 15-3: Valuation summary

	2015	2016	2017	2018	2019	2020	2021-2031 LOM average
Physicals							
Total material moved (Mt)	7.6	14.5	5.1	4.2	5.8	5.0	6.0
Total tonnes mined (Mt)	6.4	13.4	2.8	1.2	4.6	2.6	3.7
Total tonnes Crusher feed (Mt)	1.6	3.1	3.1	3.2	3.2	3.3	3.3
Crusher feed Ni grade (%)	1.6%	1.5%	1.3%	1.2%	1.3%	1.3%	1.1%
Product							
Total tonnes FeNi produced (t)	69,556	139,302	132,416	123,708	134,914	152,243	162,433
FeNi grade (%)	31.0%	27.0%	26.1%	26.7%	25.0%	22.3%	18.2%
Production Ni (t)	21,562	37,611	34,547	33,018	33,728	33,900	29,421
Operating Costs (US\$M)							
Total Operating costs	204	399	350	344	348	355	369
Capital Costs (US\$M)							
Total Capital costs	34	32	28	21	21	17	16
Revenue (US\$M)							
Total Revenue	411	619	593	568	578	581	506
Taxes & Royalties (US\$M)							
Total Taxes & Royalties	76	98	95	87	90	88	59
After Tax Cash Flow (US\$M)							
ATCF	74	108	121	122	128	133	72
Cash Costs (US\$/lb)							
C1 Cash Cost	4.05	4.55	4.40	4.55	4.51	4.62	5.60
C2 Cash Cost	5.67	5.50	5.46	5.67	5.63	5.73	6.42
C3 Cash Cost	6.56	6.24	6.13	6.33	6.28	6.34	6.98
Consensus Ni price	7.90	7.90	7.90	7.90	7.90	7.90	7.90

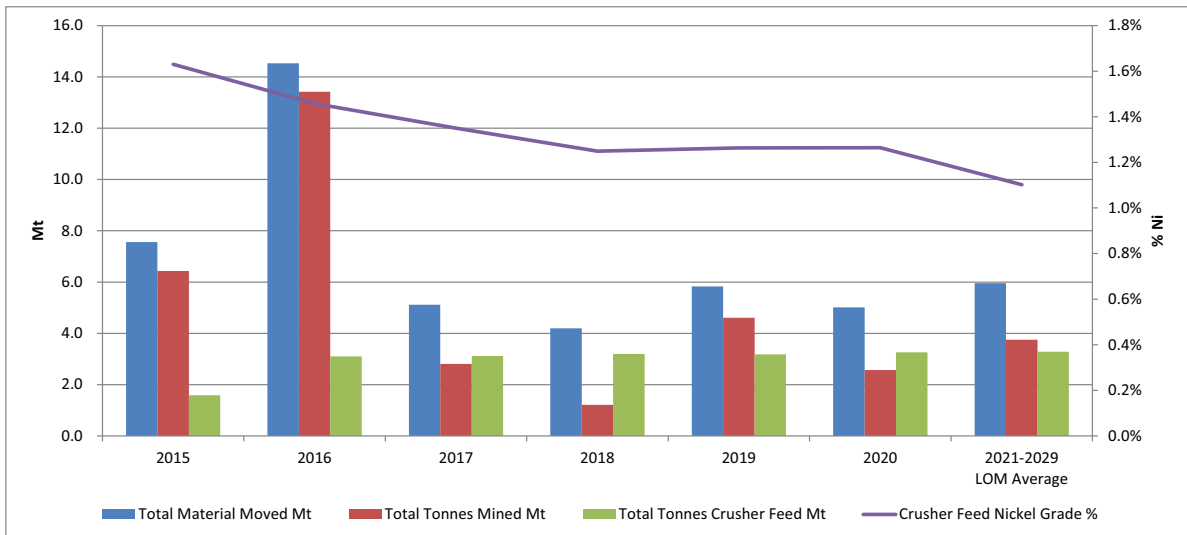

Figure 15-3: Mine production profile

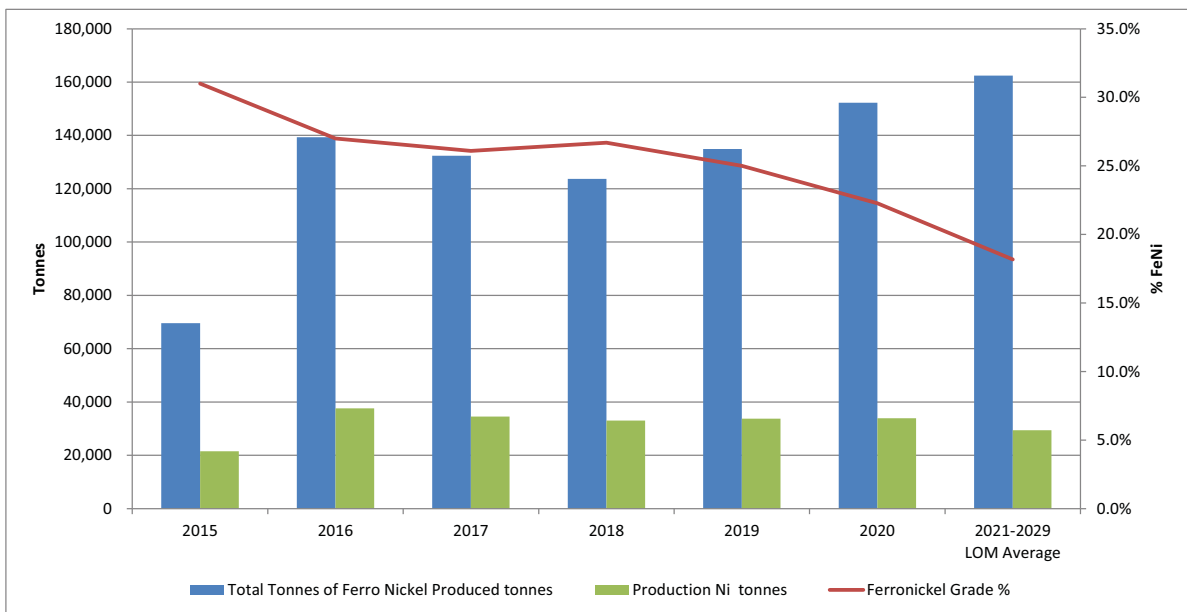

Figure 15-4: Ferronickel production profile

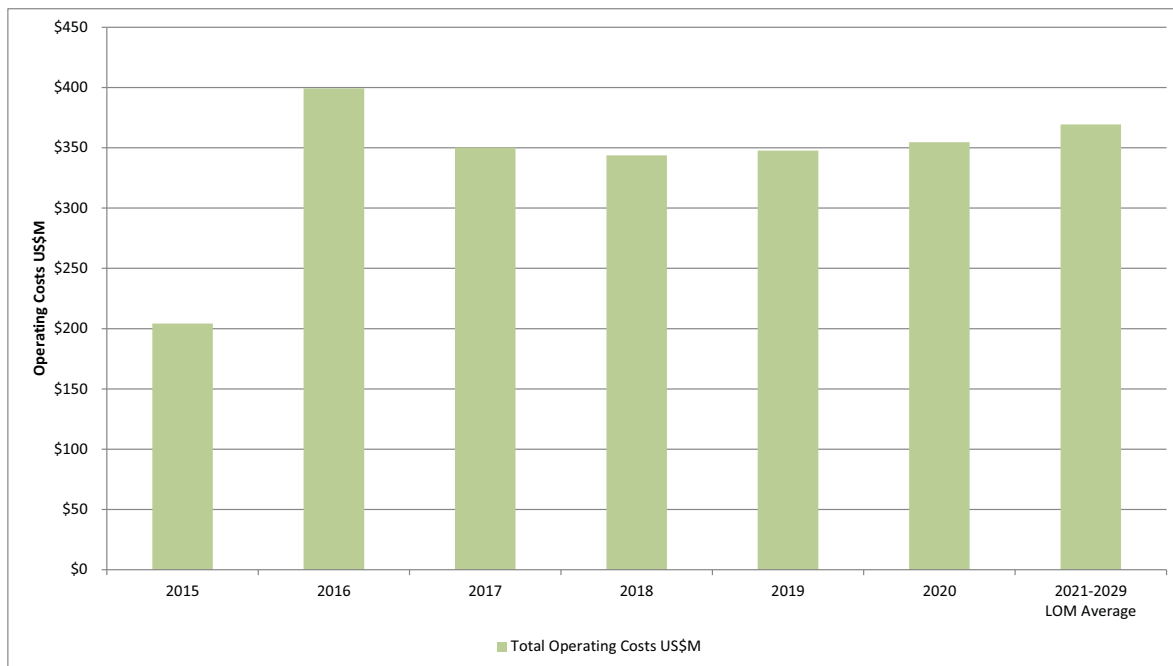

Figure 15-5: Operating costs



Figure 15-6: Capital costs

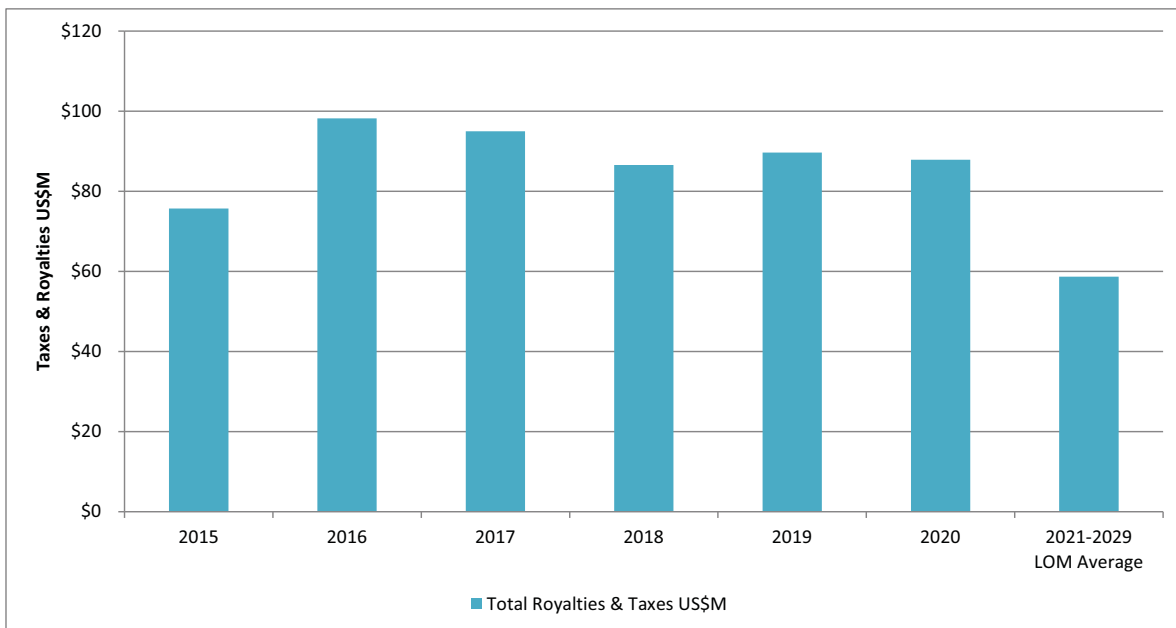

Figure 15-7: Taxes & royalties

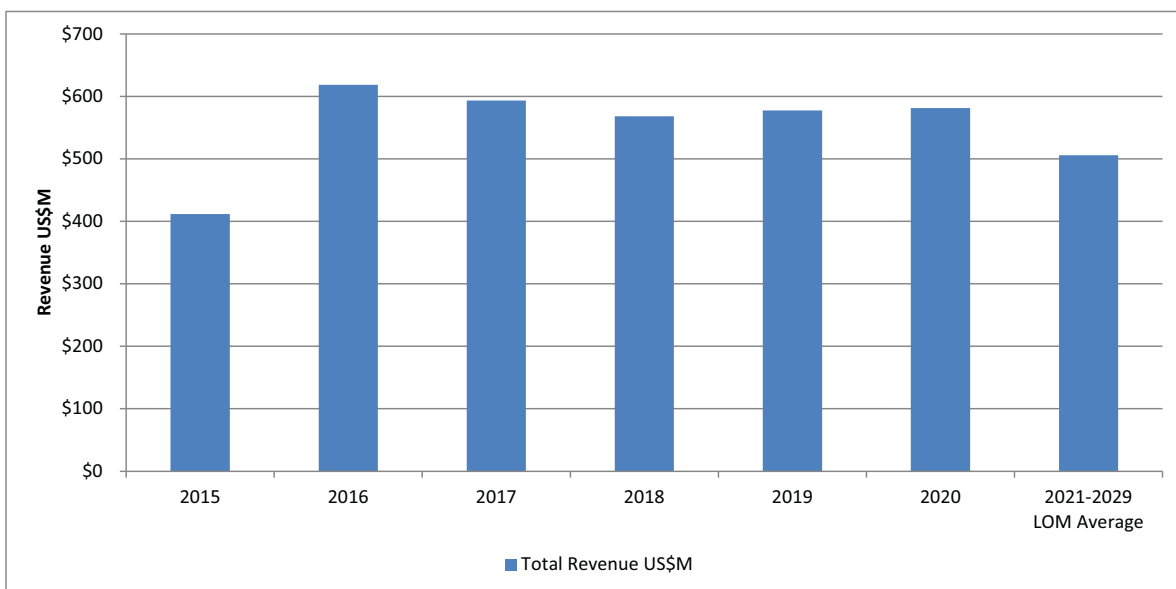

Figure 15-8: Revenue

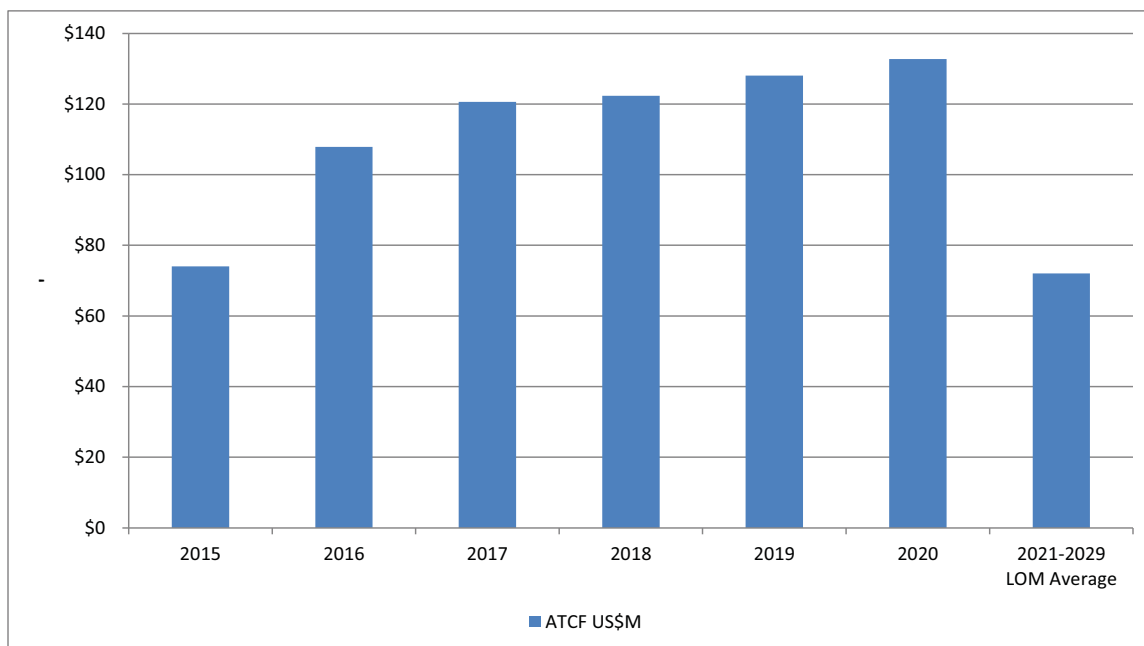

Figure 15-9: After tax cash flow

15.4 Benchmarking

15.4.1 Introduction

The following section includes the results of a cost benchmarking analysis for global nickel producers. The purpose of the analysis is to ascertain where the 2015 C1 cash cost falls with respect to the various quartiles representing the nickel mining industry.

15.4.2 Definitions

Cash costs as defined here are generally based on the C1 basis, which includes all operating costs required to receive the sales revenue as projected. Accordingly, the numerator is the summation of the following operating costs: mining (waste+ore), processing, site overheads, transportation costs, treatment charges, refining charges, realisation charges and mineral royalties, but excludes corporate taxation, corporate overheads, environmental closure costs, terminal benefits liabilities, financing charges and all non-cash items such as depreciation and amortisation charges. The denominator in the determination of the unit C1 costs is then based on the payable unit of metal. With respect to reporting convention, the following two principal methods are applied:

- By-product reporting whereby the sales revenue from defined by-products are recorded as a deduction against operating expenses and the resulting numerator is divided by the principal payable product
- Co-product reporting whereby the denominator is determined by the summation of equivalent principal payable product. In this case, the by-products are converted to equivalent principal payable products based on the ratio of total sales revenue to principal product unit sales revenue.

C2 and C3 costs are typically defined as:

- C2 Cash Cost is the sum of the C1 Cash Cost and depreciation, depletion and amortisation
- C3 Cash Cost is the sum of the C2 cash cost, indirect costs and net interest charges. The indirect costs include corporate costs, royalties and “front-end” taxes and extraordinary costs such as strikes and unexpected shutdowns.

15.4.3 2015 Cash cost comparison

Figure 15-10 shows the current LOM C1, C2 & C3 Cash Cost profile for CMSA, also plotted are the Consensus nickel forecasts used by SRK in this valuation. The forecast C1 Cash Cost for 2015 is US\$4.05 per/lb Ni. Figure 15-11 shows the Global C1 Nickel Cash Cost Curve (by-product). It can be seen that with a C1 Cash Cost of US\$4.05/lb Ni, CMSA is a Second Quartile producer on the Global Ni Cost Curve.

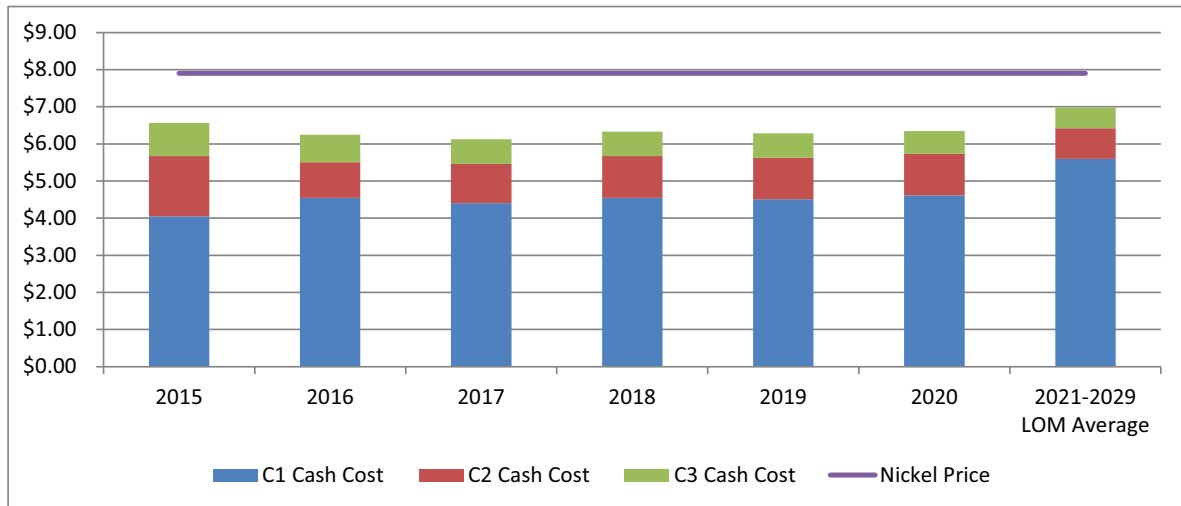

Figure 15-10: LOM cash cost profile

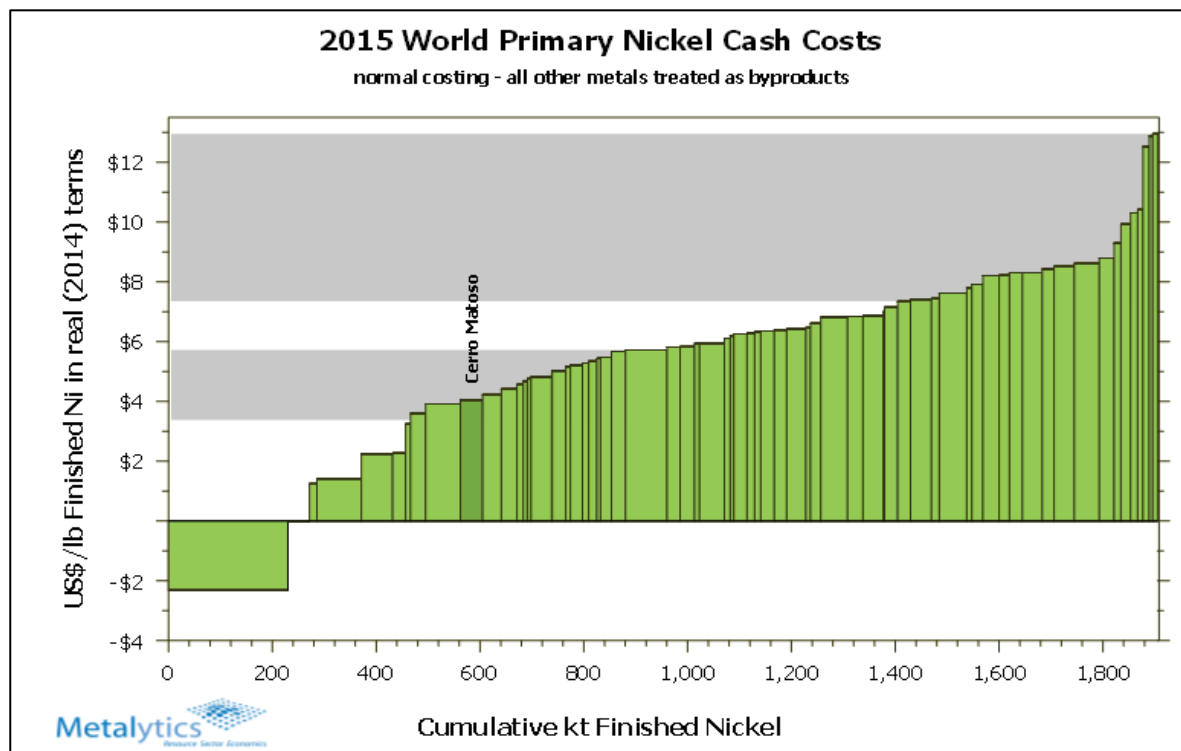

Figure 15-11: C1 nickel cash costs

Source: Metalytics (2014)

15.5 Discounted cash flow result

Table 15-4 presents the result of SRK's Technical Value of the Ore Reserve for CMSA, based on BHP Billiton's 99.98%.

SRK values CMSA within the range of US\$528M to US\$669M, with a preferred value of US\$593M, at a nominal discount rate of 13.6%.

Table 15-4: Valuation summary

SRK scenario	Discount rate	NPV US\$M
SRK Valuation Downside	16.6%	528.5
SRK Valuation Preferred	13.6%	592.8
SRK Valuation Upside	10.6%	669.5
Internal Rate of Return	NA	NA

This valuation is reflective of the CMSA project, based on SRK's view in relation to Ore Reserves only. It is important to emphasise that this value does not represent the value of the Reserves in the ground in isolation, but rather, incorporates the value of all net assets contributing to the project based on an Ore Reserves production profile. For example, at CMSA, this includes the value of the mine, truck fleet and processing facilities.

15.6 Sensitivity analysis

Table 15-5 and Figure 15-12 show the results of SRK's sensitivity analysis. SRK has found the Project's NPV to be most sensitive to changes in the Ni price and operating cost.

Figure 15-13 shows the sensitivity of NPV to changes in Discount Rate.

Table 15-5: Sensitivity analysis

Variance	OPEX	CAPEX	Ni price	Exchange rate
25%	244.2	564.6	1,076.6	709.8
20%	318.0	570.2	979.8	690.3
15%	387.6	575.9	883.0	669.1
10%	456.7	581.5	786.3	646.0
5%	524.8	587.1	689.5	620.7
0%	592.8	592.8	592.8	592.8
-5%	660.8	598.4	496.0	562.0
-10%	728.9	604.1	398.8	527.8
-15%	796.9	609.7	300.0	489.5
-20%	864.9	615.4	189.2	446.5
-25%	933.0	621.0	68.0	397.0

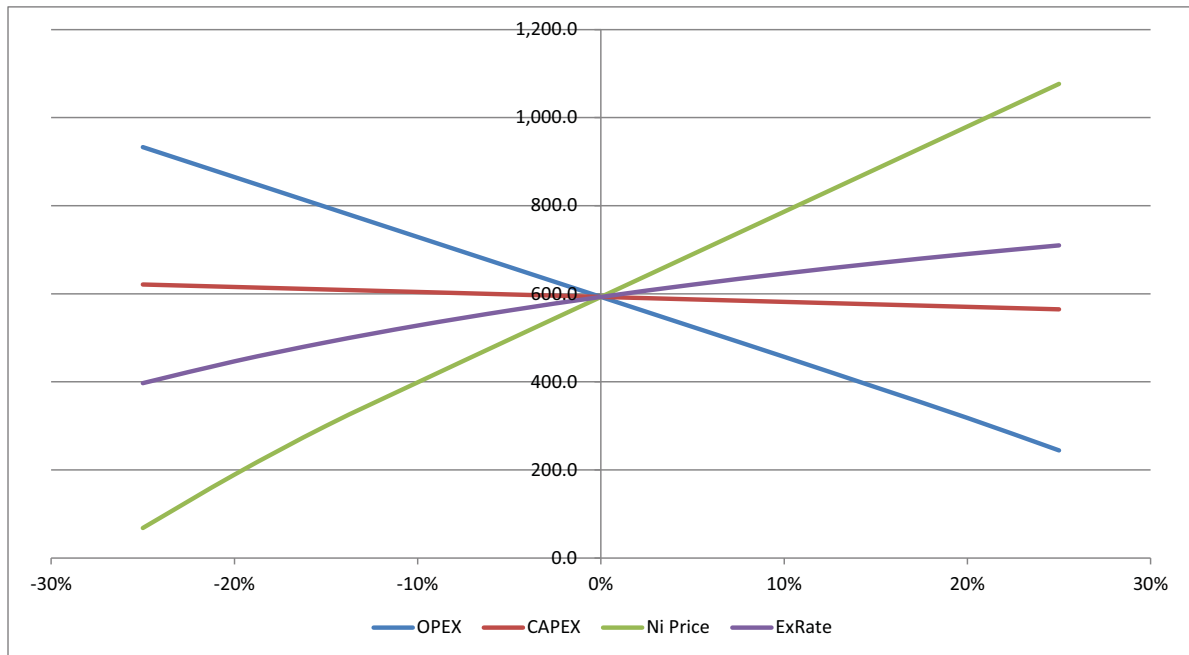

Figure 15-12: Sensitivity analysis

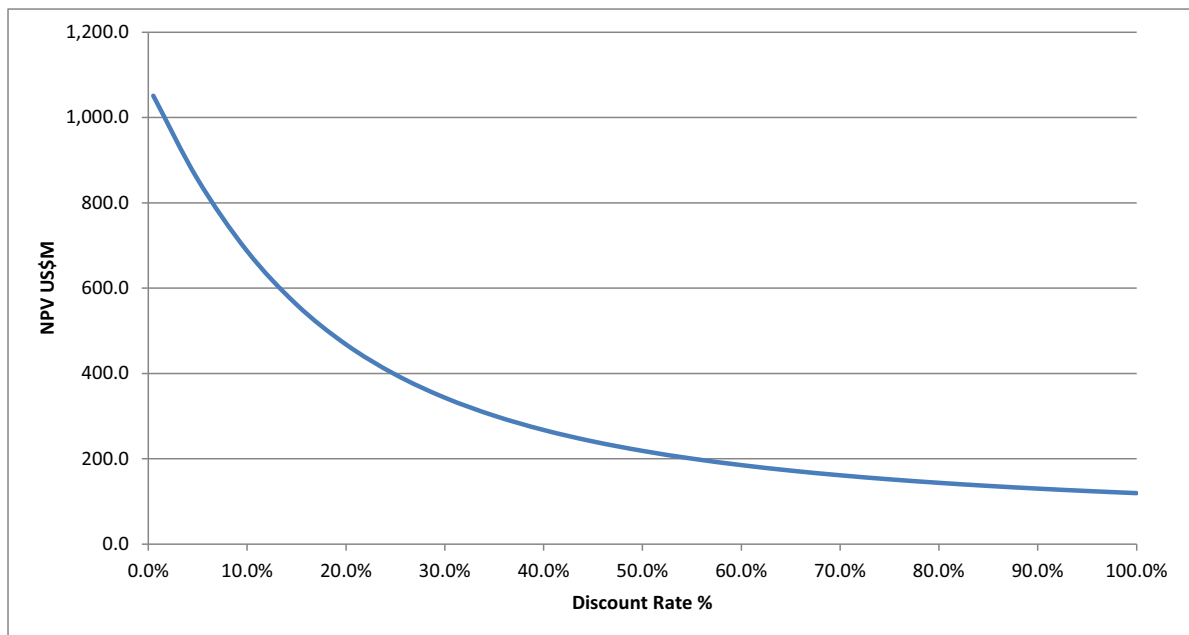

Figure 15-13: NPV versus discount rate

15.7 Comparable transaction analysis

15.7.1 Nickel and Cobalt price history 2005 to 2014

The nickel and cobalt price history, as well as the Nickel LME Warehouse level, for the period July 2005 to October 2014 is provided in Figure 15-14.

It is worth noting that low supplies of nickel, as inferred from the LME warehouse levels, led to a conspicuous spike in the nickel price in 2007, followed by a spike in the cobalt price in 2008. Both nickel and cobalt prices have since returned to price levels similar to those prevailing before the 2007 boom.



Figure 15-14: Nickel and cobalt price history, 2005 to 2014

Source: InfoMine

Nickel equivalent tonnes

In assessing nickel laterite transactions involving projects with material cobalt grades, SRK considered the transactions on the basis of nickel equivalent tonnes, using the following formula:

$$\text{Ni Equivalent tonnes} = \text{Ni tonnes} + \text{Co tonnes} * (\text{Co price} / \text{Ni price}) \text{ at time of transaction}$$

Note that metallurgical recovery factors have not necessarily been disclosed for all projects at the time of the transactions considered. For the sake of consistency in comparing and analysing transactions, **SRK has assumed 100% recovery of both Ni and Co in analysing all transactions.**

This will have the effect of overestimating recoverable Co tonnes for all transactions, which will result in more conservative (i.e. lower) implied prices per tonne of nickel equivalent for those projects with material Co credits, as the transaction consideration is fixed for each transaction. Therefore, the effect of overestimating nickel equivalent tonnes will decrease the implied price paid per tonne of nickel equivalent. Based on the relative grades and tonnes of nickel and cobalt, SRK does not believe that this will have a material effect on the valuation.

15.7.2 Comparative transactions

SRK considered 38 transactions involving nickel laterite properties during the period 1 January 2010 to 16 October 2014, and a further 48 transactions involving nickel laterite properties during the period 1 January 2005 to 1 January 2010. A total of 12 of these transactions, involving nine properties, concerned individual nickel laterite properties including declared resources and/or reserves at the time of the transaction, with sufficient information available in the public domain to allow an analysis of the transaction on the basis of declared resources or reserves (Table 15-6).

Three of the transactions (two projects) involved projects in Guatemala, three transactions (three projects) involved properties in the Philippines, two transactions (one project) involved a property in

Madagascar, two transactions (one project) involved a property in Turkey, one transaction involved a property in Indonesia and one transaction involved a property in Australia.

Of the 12 transactions analysed, only nine involved projects with declared reserves at the time of the transaction (Table 15-7). One of the projects had only declared reserves at the time of the transaction (full conversion of Resources to Reserves, with no declared Resources outside of the mine plan), so only 11 projects could be analysed in terms of resources (inclusive of reserves) (Table 15-8).

The transactions were analysed in terms of the implied total purchase price in US dollars and the total nickel tonnes contained in the declared reserves and resources, as well as the nickel equivalent tonnes, assessed by SRK using the formula discussed in the section above. All values and factors quoted are in US dollars. Consideration paid in shares was considered at a 10% discount to cash consideration, and contingent payments were risk-weighted. The timing of payments, as set out in the initial agreements, was also taken into account.

The nickel price at the time of the transaction was considered, and the implied US\$/t price was normalised to the average October 2014 nickel price (US\$16,479/t).

Table 15-6: Summary of relevant transactions involving nickel laterite projects between January 2005 and October 2014

Transaction	Country	Project Stage	Date transaction announced	Ni Price	Co Price	Buyer	Seller	Equity	Remarks
Fenix '11	Guatemala	Feasibility	Aug-11	27,800	35,015	Solway Investment Group Limited	Hudbay Minerals Inc	98.2%	Solway Investment Group Ltd paid \$140M in cash to acquire a 98.2% stake in Fenix ferronickel project from Hudbay Minerals Inc. Additionally, Solway Investment Group Ltd will also pay \$30M as contingent payments, upon satisfaction of certain conditions during the course of Solway's development of the project.
Fenix '08	Guatemala	Preproduction	Jun-08	22,549	99,225	Hudbay Minerals Inc	Skye Resources Inc	98%	In June 2008, Hudbay Minerals acquired all outstanding shares in Skye Resources by issuing 0.61 Hudbay shares and C\$0.001 for each ordinary Skye share. Skye's major asset was its 98.2% interest in the Fenix project.
Mayaniquel	Guatemala	Reserves Development	May-14	11,845	30,400	Cunico Resources NV	Anfield Nickel Corp.	100%	In April 2014, Cunico Resources agreed to acquire Anfield's Mayaniquel project for a final purchase price to be determined by the prevailing Ni price 5 years from the closing date of the transaction. Payment will consist of 5 annual payments of US\$3M, with a final payment of US\$ 28M on the 5th anniversary of the closing date, subject to adjustment by the following formula: (Year 5 average nickel price/\$14,000 * \$43M) - \$15M.
Acoje	Philippines	Feasibility	May-07	50,575	65,202	European Nickel Plc	Rusina Mining NL	40%	In May 2007, Rusina signed an agreement with European Nickel for the sale of a 40% interest in all nickel laterite resources at the Acoje project. Under the agreement, European Nickel can earn the 40% by fully subscribing to a £1M (US\$1.99M) private placement, and by providing US\$10M for an Acoje laterite feasibility study. The deal excludes the nickel-chromite-PGM sulfide portion of the project.

Transaction	Country	Project Stage	Date transaction announced	Ni Price	Co Price	Buyer	Seller	Equity	Remarks
Ambatovy '10	Madagascar	Preproduction	Aug-10	14,575	38,006	Hyundai Heavy Industries Co Ltd; Samsung Corp.; Hyundai Corp.	Korea Resources Corp	5%	An investor group, comprised of Hyundai Heavy Industries Co Ltd, Samsung Corp. and Hyundai Corp., paid \$140.0M to acquire a 5% stake in Ambatovy from Korea Resources Corp.
Ambatovy '06	Madagascar	Feasibility	Oct-06	32,703	39,073	SNC-Lavalin Group; Korean Consortium	Sumitomo Corp; DMC Mining Services	35%	In October 2006, an investor group agreed to pay US\$852M towards meeting the projects equity and debt financing requirements, in exchange for a 35% interest in the project.
Agata	Philippines	Feasibility	Sep-13	19,227	28,500	Mindoro Resources Ltd	Minimax Mineral Exploration	25%	In September 2013, Mindoro renegotiated an option to acquire an additional 25% interest in Agata from Minimax. For the 25% interest, Mindoro would make an initial payment of \$200,000, write off an existing \$5.3M Minimax debt due to Mindoro, and annual payments of \$1M to Minimax for four years. Minimax would receive a 0.5% NSR royalty.
Caldag '11	Turkey	Feasibility	Sep-11	31,750	31,995	Oremin Madencilik	ENK plc	100%	In September 2011, ENK agreed to sell its 100% interest in Caldag to Oremin for US\$4M in cash.
Caldag '05	Turkey	Feasibility	Jul-05	14,670	30,032	BHP Billiton Ltd	ENK plc	5.6%	In July 2005, BHP Billiton exercised its option to acquire a further 5.6% interest (5.8 million ordinary shares) in European Nickel for US\$4.3 million. After the transaction, BHP Billiton held an 8.9% interest in European Nickel, whose major asset was the Caldag project.
La Sampala	Indonesia	Reserves Development	Dec-10	23,507	38,507	Sherritt International Corporation	Rio Tinto plc	57.5%	In December 2010, Sherritt agreed to acquire a 57.5% interest in La Sampala by funding a feasibility study for US\$110M. SNL reports that the agreement was terminated, although no date of termination is provided.

Transaction	Country	Project Stage	Date transaction announced	Ni Price	Co Price	Buyer	Seller	Equity	Remarks
Lucky Break	Australia	Feasibility	May-13	28,205	28,000	Metals Finance Limited	Metallica Minerals Ltd	60%	Metals Finance Limited has signed an Option Agreement to acquire the remaining 60% of the Lucky Break Project that it does not already control, from JV partner, Metallica Minerals Limited, for a cash consideration of \$1M.
Mindoro	Philippines	Feasibility	Sep-10	15,300	39,006	Severstal Group	Intex Resources ASA	22%	Lybica Holding, an Amsterdam-based subsidiary of Severstal Resources, acquired a 21.71% interest in Oslo-based Intex Resources for a total consideration of US\$12.5M in cash. Intex's main asset is the wholly-owned feasibility-stage Mindoro nickel-cobalt-iron-chromium project in the Philippines.

Data sourced from SNL and Intierra databases as well as company websites.

Table 15-7: Transactions analysed in terms of reserves

Transaction	Project Stage	Reserve Tonnes (Mt)	Class.	Ni Grade (%)	Co Grade (%)	NiEq Grade (%)	Ni Tonnes ('000 t)	Co Tonnes ('000 t)	NiEq Tonnes ('000 t)	\$/t Ni Reserves	Normalised	\$/t NiEq Reserves	Normalised
Fenix '11	Feasibility	36.2	Proven Probable	1.76		1.76	637.0	-	637.07	223.81	139.66	223.81	139.66
Fenix '08	Preproduction	41.4	Proven Probable	1.63		1.63	674.8	-	674.87	731.60	562.85	731.60	562.85
Mayaniquel	Reserves Development	69.9	Proven Probable	1.41		1.41	985.4	-	985.47	35.72	52.31	35.72	52.31
Ambatovy '10	Preproduction	125.0	Proven Probable	1.04	0.099	1.30	1,300.0	123.8	1,622.7	2,153.85	2,563.63	1,725.52	2,053.82
Ambatovy '06	Feasibility	125.0	Proven Probable	1.04	0.099	1.16	1,300.0	123.8	1,447.9	1,872.53	993.32	1,681.31	891.89
Agata	Feasibility	33.0	Proven Probable	1.02	0.05	1.09	336.2	16.5	360.6	100.97	91.10	94.13	84.93
Caldag '11	Feasibility	33.2	Proven	1.13	0.07	1.20	375.2	23.2	398.6	106.62	58.26	100.36	54.83
Caldag '05	Feasibility	36.0	Proven Probable	1.30	0.07	1.44	468.0	25.2	519.6	164.07	194.02	147.78	174.76
Mindoro	Feasibility	126.3	Proven Probable	0.95	0.06	1.10	1,199.9	75.8	1,393.0	48.18	54.63	41.50	47.06

Data sourced from SNL and Intierra databases as well as company websites.

15.7.3 Analysis of transactions

When considering all nine transactions involving nickel laterite projects with declared reserves at the time of the transaction (Table 15-8 and Figure 15-15 to Figure 15-17), the implied US\$/t transaction prices in terms of contained nickel tonnes within declared reserves ranged from US\$35.72/t to US\$2,153.85/t, with a median of US\$164.07/t and a weighted average of US\$840.28/t. This changed to a range of US\$52.31/t to US\$2,563.63/t with a median of US\$139.66/t and a weighted average of US\$735.69/t when normalised to the October 2014 average nickel price of US\$16,479/t.

In terms of nickel equivalent tonnes, the implied range was US\$35.72/t to US\$1,725.52/t, with a median of US\$147.78/t and a weighted average of US\$760.52/t. This changed to a range of US\$47.06/t to US\$2,053.82/t with a median of US\$139.66/t and a weighted average of US\$665.85/t when normalised to the October 2014 average nickel price of US\$16,479/t.

Table 15-8: Analysis of transactions in terms of Reserves

Grouping	Statistic	US\$/t Ni Reserves	Normalised	US\$/t NiEq Reserves	Normalised
All	Number	9	9	9	9
	Minimum	35.72	52.31	35.72	47.06
	Maximum	2,153.85	2,563.63	1,725.52	2,053.82
	Median	164.07	139.66	147.78	139.66
	Mean	604.15	523.31	531.30	451.35
	Weighted Average	840.28	735.69	760.52	665.85
Excluding Mayaniquel and Mindoro	Number	7	7	7	7
	Minimum	100.97	58.26	94.13	54.83
	Maximum	2,153.85	2,563.63	1,725.52	2,053.82
	Median	223.81	194.02	223.81	174.76
	Mean	764.78	657.55	672.07	566.11
	Weighted Average	1,182.69	1,028.47	1,063.61	924.92

The Mayaniquel project was at an earlier stage of development than the other projects at the time of the transaction, as the Mayaniquel project was not yet the subject of a feasibility study at the time of the transaction, whereas the other projects were. The Mayaniquel transaction was therefore excluded.

The Mindoro project had the largest declared reserve base at the time of the transaction, although the grade was very low, and the implied transaction price in US\$/t was also very low, the lowest of the transactions involving reserves considered, and the only one below 1% Ni (CMSA Reserves have a grade of 1.2% Ni). This transaction therefore had an unduly large influence on the weighted average, and was also excluded.

The Ambatovy transaction in 2010 is significantly higher than the other transactions, and influences the weighted average transaction price. As this transaction represents the most advanced project (closest to production) of all transactions considered, SRK is of the opinion that the implied premium is justified. As CMSA represents an operating mine with a very large resource base, SRK is of the opinion that the Ambatovy 2010 transaction is a reasonable comparable transaction.

After excluding the Mayaniquel and Mindoro transactions, the median and weighted average of the seven remaining transactions were US\$194.02/t and US\$1,028.47/t respectively. These changed to US\$174.76/t and US\$924.92/t respectively when normalised to the October 2014 average nickel price of US\$16,479/t. SRK considers this factor, US\$924.92/t, to be a suitable factor on which to base a market-based valuation of the CMSA nickel laterite reserves.

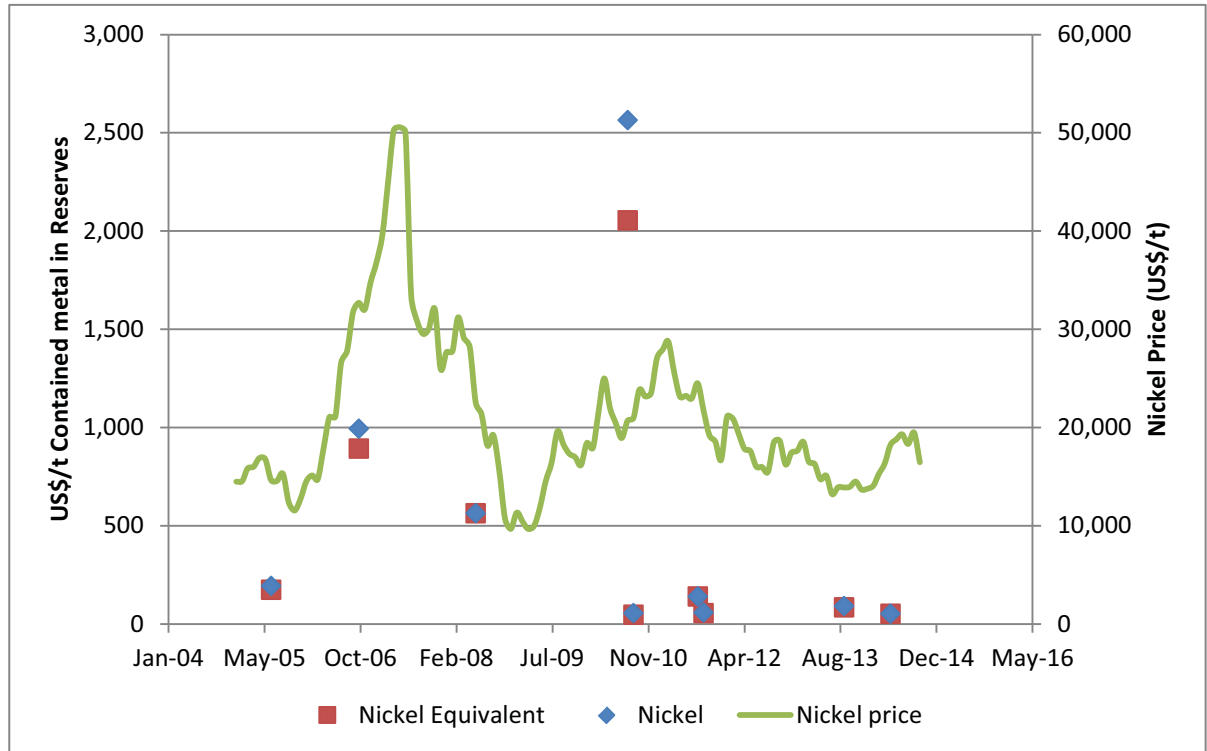

Figure 15-15: Transactions involving Ni laterite projects with declared reserves

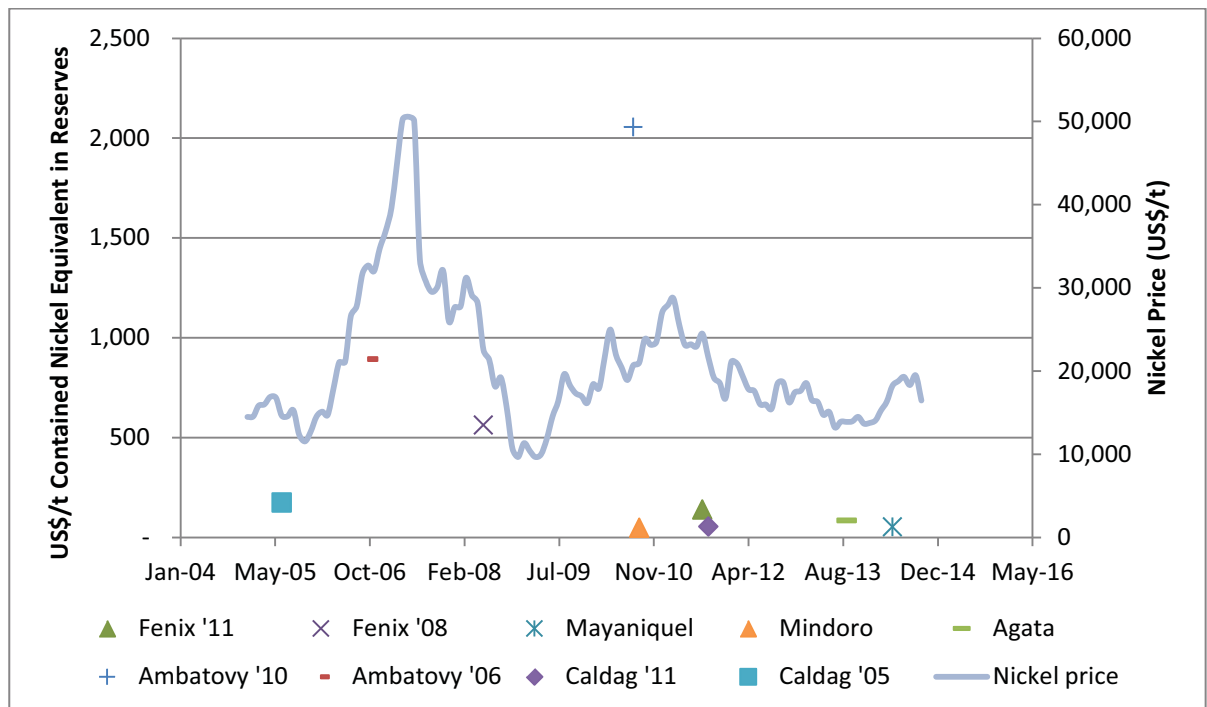

Figure 15-16: Transactions involving Ni laterite properties with declared reserves

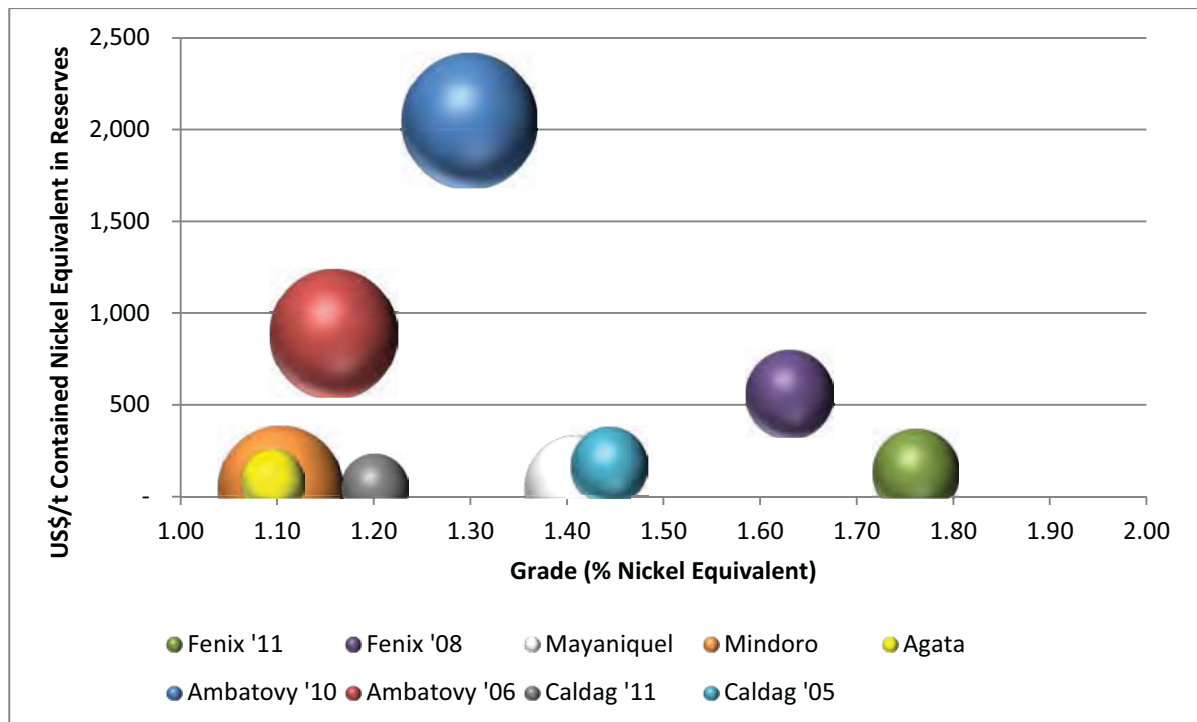

Figure 15-17: Grade and contained metal versus normalised transaction prices in US\$/t

15.7.4 Comparison with Yardstick method

In the Yardstick method of valuation, specified percentages of the spot price of the metal is used to value the Resources and Reserves.

Commonly used Yardstick factors are:

- Not in reported resource: <0.5% of spot price
- Inferred Resources: 0.5% to 1% of spot price
- Indicated Resources: 1% to 2% of spot price
- Measured Resources: 2% to 5% of spot price
- Reserves 5% to 10% of spot price.

SRK notes that the Yardstick Method is not generally considered to be a suitable primary valuation method, but is considered an acceptable secondary Valuation method (Lawrence, 2012). In this case, SRK is of the opinion that the Yardstick valuation method supports the valuation range derived from the analysis of comparable transactions.

Using a nickel price of US\$15,367.00/t (average for November 2014), the factor for the valuation of reserves derived from the analysis of comparative transactions (US\$924.92/t) equates to approximately 6.0% of the spot price, which represents a reasonable value when compared to the generally accepted Yardstick factor for reserves.

SRK prefers to rely on the actual factor derived from the analysis of the comparative transactions, as this is relevant to the particular style of mineralisation, geographic area and specific market conditions prevailing.

15.7.5 Market-based valuation

On the basis of the analysis of the seven non-excluded transactions involving declared nickel laterite projects including declared reserves at the time of the transaction, SRK has concluded that a valuation factor of US\$924.92/t represents a reasonable basis for a market-based valuation of the

CMSA ore reserves. Based on the perceived level of risk involved, SRK considers a range of 15% above and below the Preferred value to represent a reasonable valuation range for ore reserves.

Using a market-based approach and the assumption that the declared Reserves account for the majority of the value, SRK would value the Cerro Matoso Ore Reserves, which has a declared Mineral Reserve base (Proved and Probable – depleted to 31 December 2014) of 47.0 Mt with a grade of 1.19% Ni for approximately 559,300 t of contained Ni in reserves, within the range of US\$440M to US\$595M, with a Preferred value of US\$517M (on a 100% basis). This falls within the implied Yardstick valuation range of US\$430M to US\$859M, based on a spot price of US\$15,367/t (average for November 2014) and the generally accepted Yardstick factors of 5% to 10% for declared reserves.

Table 15-9: Summary of market-based valuation ranges (100% basis)

Basis		Comparatives	Yardstick
Reserves	Basis (tonnes Ni)	559,300	559,300
	Factor (US\$/t)	924.92 ± 15%	5% to 10% of 15,367
	Low (US\$M)	440	430
	High (US\$M)	595	859

Considering BHP Billiton's 99.98% interest, using a market-based approach and the assumption that the declared Reserves account for the majority of the value, SRK values the Cerro Matoso Ore Reserves within the range of US\$439M to US\$595M, with a Preferred value of US\$517M. This falls within the implied Yardstick valuation range of US\$429M to US\$859M, based on a spot price of US\$15,367/t (average for November 2014) and the generally accepted Yardstick factors of 5% to 10% for declared reserves.

Table 15-10: Summary of market-based valuation ranges (99.98% basis)

Basis		Comparatives	Yardstick
Reserves	Basis (tonnes Ni)	558,964	558,964
	Factor (US\$/t)	924.92 ± 15%	5% to 10% of 15,367
	Low (US\$M)	439	429
	High (US\$M)	595	859

The NPV preferred value of US\$592M is in line with the market-based valuation based on reserves, and is also in line with the Yardstick range based on the reserve approach. SRK prefers the NPV valuation for CMSA, as the comparative transactions are based on pre-production properties, whereas CMSA is an operating mine, which should therefore attract a premium. SRK considers the comparable transactions provide a reasonable basis for the lower end of the valuation range, and together with the yardstick approach, provides a reasonable cross check and secondary valuation technique, as suggested by the VALMIN Code.

15.8 Risk and Opportunities

- Exchange rate: The Project's NPV is sensitive to fluctuations in the Colombian peso versus United States dollar exchange rate. A 25% decrease in the COP/US\$ exchange rate over the long term will result in a US\$195M reduction in the NPV of the Project.
- Nickel prices: The Project's NPV is sensitive to fluctuations in the price of Nickel. A 25% fall in the Nickel price from current consensus levels will result in a US\$524M reduction in NPV to US\$68M.

- Industry competition: Nickel is a competitive industry with little product differentiation. There is a risk that Indonesia could reverse its NPI export bans. This could negatively affect the Ni price and the Project's NPV. A competitive advantage for CMSA is that it is a producer in the second quartile of the cost curve. There is also an opportunity for CMSA if the Philippines were to introduce an NPI export ban; this would be positive for the Ni price and CMSA.
- Global economy: A slowdown in the global economy could affect demand for CMSA's product.
- Operating costs: The project is sensitive to changes in operating cost; a 25% increase in operating costs will reduce the NPV to US\$244M.

15.9 Summary comments

SRK has undertaken a Technical Valuation of the Ore Reserves of CMSA. SRK's valuation has excluded the valuation of Measured, Indicated and Inferred Resources.

SRK values CMSA within the range of US\$528.5M to US\$669.5M, with a preferred value of US\$592.8M at a nominal discount rate of 13.6% as at 31 December 2014.

Investors in this CMSA need to be aware that the current Technical Valuation of ore reserves is valid at the date of issue. However, future changes in circumstances may affect the valuation either positively or negatively, moving forward. Valuations conducted at a future date based on changed circumstances may result in a different result than that obtained by SRK at this valuation date.

16 Concluding Remarks

16.1 Introduction

The following section presents a summary of SRK's opinion in respect of CMSA, with reference to the 2014 Statements (SRK Depleted) and the Valuation of CMSA (99.98% holding). SRK has carried out a comprehensive review and technical assessment of all material issues likely to influence future operations based on the current Ore Reserves.

SRK concludes that the Mineral Resources and Ore Reserves as stated herein are reported in accordance with the terms and definitions of the JORC Code (2012). Mineral Resources are reported inclusive of Ore Reserves.

16.2 Mineral Resources and Ore Reserves

Table 16-1 and Table 16-2 present the Mineral Resources and Ore Reserves (SRK Depleted) respectively.

Table 16-1: Mineral Resource as at 31 December 2014 (inclusive of Reserves)

Classification	Type	Ore (Mdt)	Ni%	Fe%	MgO%	SiO ₂ %	Al ₂ O ₃ %
Measured Resource	Laterite	42	1.2	11.8	21.5	42.8	2.3
	Stockpiles	49	1.1	17	19.8	37.4	2.1
Indicated Resource	Laterite	178	0.9	18.9	9.4	36.3	4.4
Inferred Resource	Laterite	66	0.8	18.8	9.1	37.2	4.9
Total		335	0.9	17.7	12.5	37.5	3.9
MNR Ore – Measured Resource ⁽¹⁾		17	0.2	-	-	-	-

Table 16-2: Ore Reserves as at 31 December 2014

	Ore (Mdt)	Ni%	Source
Reserve as at 30 June 2014*	48.5	1.2	CMSA CP Report 2014
Depletion July 2014 to Oct 2014 (actuals)	0.95	1.62	Monthly reports
Forecast Nov 2014	0.26	1.64	5YP_Plan quinquenal FY15toFY19RTV4.0_20140327
Forecast Dec 2014	0.27	1.64	5YP_Plan quinquenal FY15toFY19RTV4.0_20140327
Calculated Reserve Estimate as at 31 December 2014	47.0	1.19	

16.3 Valuation

The preferred Technical Value based on CMSA's Ore Reserves is US\$593M (99.98% holding).

This value is derived from the net present value of the after tax cash flows as determined in the financial model, assuming consensus market forecasts and a long term Ni price of US\$7.90/lb.

16.4 Principal issues

SRK has carried out a detailed technical review and defines the following principal technical issues that will impact the 2014 Statements (SRK Depleted) as the following.

Specific risks

- Geological structures are now impacting the lower regions of the deposit and while appearing to create more ore at depth, also introduce increased variability, which in turn is impacting reconciliation.
- Processing feed from stockpiles is increasing over the coming years. However, there is uncertainty over the existing stockpile density which also is affected reconciliation and the ability to accurately control feed specifications.
- Ore from the remaining Ore Reserve will increase in silica which will affect the SiO₂: MgO ratio. This potentially alters the furnace slag characteristics and may generate operational problems, as well as potentially affecting the ability to process all of the available ore.
- Due to the declining grade, the Ni % in final FeNi granules will drop and this may impact final sales prices, in addition to increasing the unit cost (US\$/lb) of overall Ni production.
- Ongoing capital projects will effectively increase the unit cost of production.

Specific opportunities

- An updated Resource Model, based on significantly increased drilling between December 2011 and July 2014, is due in late 2014. This predominantly infill drilling, targeting the basement structures will allow an increase in classification (of Measured), but is unlikely to have an impact on the global resource tonnage and grade.
- The mining of Esmeralda (once appropriate social and environmental permits have been secured) will provide ore at an increased grade that should increase the processing feed grade by ~0.2% Ni.
- Testwork currently being carried out on an Upgrade circuit will be beneficial in that it will reduce the amount of silica in the furnace feed as well as uplift the processing feed grade.

Project Code: BHP151

Report Title: A Competent Person's Report and Valuation Report on Cerro Matoso, Colombia

For and on behalf of SRK Consulting (Australasia) Pty Ltd

Competent Person – Mineral Resource



Danny Kentwell

Principal Consultant

Competent Person – Ore Reserve

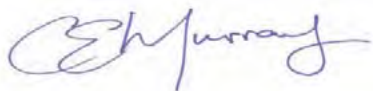

Carl Murray

Principal Consultant

Competent Person – Valuation

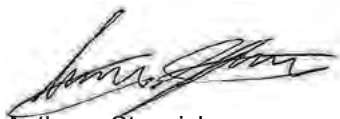

Anthony Stepcich

Principal Consultant

List of Abbreviations

Abbreviation	Meaning
5YP	5-year plan
Al ₂ O ₃	Aluminium oxide
ANLA	Autoridad Nacional de Licencias Ambientales
ARD	absolute relative difference
ATCF	after tax cash flow
AusIMM	Australasian Institute of Mining and Metallurgy
BHP BILLITON	BHP Billiton
CaO	calcium oxide
CMF	consensus market forecasts
Co	cobalt
COG	cut-off grade
COP	Colombian peso
CP	Chartered Professional
CPR	Competent Person's Report
CRM(s)	certificated reference material(s)
CVS	Corporación Autonoma Regional de los valles del Sinu and San Jorge
DCF	discounted cash flow
DEMA	Documento de Evaluación y Manejo Ambiental
DGPS	differential global positioning system
dmt	dry metric tonne
DPS	Department for Social Prosperity
DTM	digital terrain model
ESIA	Environmental and Social Impact Assessment
Fe	iron
FEL(s)	front end loader(s)
FeNi	ferronickel
g/L	grams per litre
ha	hectares
HR	Human Resources
HSEC	Health, Safety, Environment and Community
ICA	Informe de Cumplimiento Ambiental
ILO	International Labour Organisation
IRA(s)	inter-ramp angle(s)
JORC Code	The 2012 Australasian Code for Reporting of Exploration Results, Mineral Resources and Ore Reserves as published by the Joint Ore Reserves Committee of The Australasian Institute of Mining and Metallurgy, Australian Institute of Geoscientists and Minerals Council of Australia
JSE	Johannesburg Stock Exchange
kg/t	kilograms per tonne
kt	kilotonnes
ktpa	kilotonnes per annum

Abbreviation	Meaning
lb	pound
LOM	life of mine
LOMP(s)	life of mine plan(s)
LSE	London Stock Exchange
LTP	long-term price
M	million
MADS	Ministerio de Medio Ambiente y Desarrollo Sostenible
masl	metres above sea level
MCAF	Mining cost adjustment factor
Mdt	million dry tonnes
MEP	Mine Expansion Project
MgO	magnesium oxide
MHP	mixed Ni-Co hydroxide precipitate
MNR	Metal Nickel Recovery
Mt	million tonnes
Mtpa	million tonnes per annum
Ni	nickel
NPI	nickel pig iron
NPV	net present value
NYSE	New York Stock Exchange
OHS	Occupational health and safety
PAHO	Pan American Health Organisation
PCAF	Processing cost adjustment factor
QA/QC	quality assurance/quality control
RC	reverse circulation
RKEF	Rotary Kiln-Electric Furnace
RL	relative level
ROM	Run of Mine
SCOP	Stockpile Chemistry Optimisation Project
SEC	Securities Exchange Commission
SiO ₂	silica (silicon dioxide)
SMU(s)	selective mining unit(s)
SRK	SRK Consulting (Australasia) Pty Ltd
t/m ³	tonnes per cubic metre
TEP	technical and economic parameter
tph	tonnes per hour
TRIF	Total Recordable Injuries Frequency
TSF	tailings storage facility
UKLA	United Kingdom Listing Authority
US\$	United States dollars
VALMIN Code	Code for the Technical Assessment and Valuation of Mineral and Petroleum Assets and Securities for Independent Expert Reports: The VALMIN Code (2005 Edition)

Appendix A: Key terms - Otrosí N° 4

<p style="text-align: center;">Warranties and Caps</p>	<ul style="list-style-type: none"> • Clauses 5 and 16: The Mining Authority (MA) does not guarantee to CMSA the existence of minerals nor shall it be liable if they are not found. The MA shall have no liability in the event mining rights were recognized to 3rd parties prior to the date of Amendment 4, but the obligations under the latter shall be proportionately adjusted. • Clause 8: CMSA guarantees that it shall explore and exploit in a complete and rational manner, with full technical and managerial autonomy, seeking to avoid deterioration or non-utilization of the deposits. • Clause 10: On the concept of regional investment, CMSA should undertake a contribution equivalent to \$ 10 million before December 31, 2016, for social projects or program of high impact in the Córdoba region. • Clause 12: CMSA guarantees that the future heap leaching processing agreement with an affiliate shall include an obligation for the latter to, upon termination of Contract 051 and under conditions to be agreed at that given date by the affiliate and the MA or 3rd party, process mineral from the contract's area for the MA or a 3rd party to be appointed by it, provided that: (i) the processing operations continue at the time; (ii) the MA or the third party have the right to exploit the contract's area; (iii) the mineral comes from said area; (iv) the mineral meets the technical specifications that permit its processing; (v) processing will be made to the extent the processing capacity of the affiliate allows for it; (vi) the MA or the third party shall pay market price for the services. This obligation will expire if the MA does not commence supply of the mineral to the affiliate within 6 months of termination of Contract 051. The MA shall have an additional 6 months if it assumes the reasonable costs of maintaining the processing infrastructure available. • Clause 27: In the performance of Contract 051 CMSA shall give preference: (i) to the engagement of Colombian personnel and specially of at least 70% of the direct personnel from the Córdoba province and the Caribbean region²; (ii) to the contracting of Colombian firms; (iii) to the use of Colombian raw materials; and (iv) to the supply of its processed products to satisfy the needs of domestic consumption. Items (i) and (ii) provided the personnel or of firms comply with the requirements of the relevant job or of the project. This whole warranty is subject to the preference not breaching any free trade agreement entered into by Colombia. • Clause 28: Social Management: Under this clause CMSA's ongoing social investment becomes a contractual obligation of 1% of EBIT per year, with US\$ 2.5M per year as a minimum (measurable on a 5 year average basis). In addition, CMSA undertakes to carry out the studies aimed at setting forth a base line for the determinants of health and environment between the operation and its neighbouring communities, and should any affectations directly derived from the operation be evidenced, CMSA will undertake the relevant corrective measures. • Clause 29: CMSA will be liable before the MA for all works undertaken in the contract area and the latter will not assume any obligations arising out of CMSA's commercial, civil or labour contracts. Furthermore, CMSA commits that all of its Colombian services providers will comply with the applicable labour and environmental law when carrying out the activities under Contract 051. • The parties' liability is not limited.
<p style="text-align: center;">Implications of Breach or Termination</p>	<ul style="list-style-type: none"> • Clause 15: The MA may impose successive fines on CMSA of up to 1,000 monthly minimum salaries (mms) (currently 1 mms corresponds to approx. US\$300), each time and for every instance of default, provided it is not grounds for administrative lapsing. • Clause 14: CMSA shall keep in force and annually renew a performance guaranty with an insured value in an amount equivalent to ten percent (10%) of the result of multiplying the estimated annual production volume of the exploited minerals, based on what is established in the approved Works and Activities Program, by the base price for royalties fixed by the UPME or the entity that may substitute it. <i>[Same guaranty currently kept for the Concessions which annual secured value is around US\$60M].</i> • Clause 19: Any payment default by CMSA shall trigger default interest at the maximum rate permitted by law (1.5 times the current banking interest for COP. Currently, October – December 2012, the limit is an interest rate of 31.34% per annum).

² Political and geographical areas nearby the operation.

	<ul style="list-style-type: none"> • Clauses 22 and 23: The MA may declare the administrative lapsing of the contract in case of (i) non-performance of the exploration, construction or exploitation activities, or the suspension thereof for more than 6 months; (ii) reiterated payment default; (iii) assignment of the contract without the MA's consent; (iv) reiterated failure to pay fines or renew the performance guarantee; (v) undertaking mining activities in areas forbidden by law; (vi) reiterated failure to present the required reports after having already been fined, provided the event is attributable to a fault of CMSA and it materially hinders the performance of the contract; (vii) reiterated non-compliance with the technical and operational norms relating to rational exploitation, health and safety of workers or conservation of renewable natural and environmental resources; (viii) violation of laws and regulations regarding zones excluded or restricted from mining; (ix) when the origin of the exploited minerals is reported as different from that of their site of extraction, thus causing the considerations to be paid to a municipality other than that of their origin; (x) hiring people under 18 years of age to perform open pit and/or underground mining activities; (xi) the final and binding repeal of the environmental authorizations that cover exploitation activities under Contract 051-96M, in a general manner, by the National Environmental Licensing Agency or the entity that replaces it, provided that this refers to such authorizations without which the entirety of the exploitation under Contract No. 051-96M cannot continue. CMSA will have 90 days to cure the default or evidence the lack thereof. The MA will then have 60 days to issue its decision, which CMSA may appeal <i>[or may resort to the arbitration set out in the contract]</i>. As per general administrative law, termination by administrative lapsing of Contract 051 may trigger the termination of all other mining leases held by CMSA. The Ministry of Mines currently maintains that this general principle does not apply to mining leases, but its argument is not solid and this opinion may change in the future. • Clause 26: Assets shall revert for free to the MA upon any termination of the contract or its extensions.
HSEC Issues	<ul style="list-style-type: none"> • Clause 4: CMSA shall comply with all environmental obligations under the law, as well as its environmental licenses, and shall commence integration of all of its environmental management plans into a single one once the environmental authorization to carry out a new exploitation called Esmeralda (mine expansion plan) is issued. • If 5 years prior to the termination of the Contract, CMSA has not undertaken the relevant mine closing activities, in accordance with the progressive mine closing plan schedule, and provided the necessary resources for the closing of the mine, it must set up a trust with the resources needed to cover the actions identified in the closing plan, plus an additional 20% of the pending identified resources, to finalize the closing plan. Such trust will disburse the resources to cover the performance of the actions as they are undertaken.

ANNEXURE 6

INDEPENDENT COMPETENT PERSONS' REPORTS

7. Cannington – Xstract Mining Consultants
-

This page has been intentionally left blank.



11 March 2015

The Directors
South32 Limited
Level 20
Waterfront Place
1 Eagle Street
Brisbane Qld 4000
Australia

The Directors
South32 Limited
BHP Billiton Centre
171 Collins Street
MELBOURNE VIC 3000
AUSTRALIA

The Directors
BHP Billiton Plc
Neathouse Place
London WS1V 1LH
UNITED KINGDOM

Dear Sirs

Re: Competent Persons Report

At the request of South32 Limited ("South32"), Xstract Mining Consultants Pty Ltd ("Xstract") has prepared this Competent Persons Report on the Cannington silver-lead-zinc mining and processing asset located in Queensland, Australia.

It is our understanding that this report is to be included in documentation relating to the demerger from BHP Billiton Limited and BHP Billiton Plc ("BHP Billiton"), and subsequent admission of South32 on the Australian Securities Exchange ("ASX"), the Johannesburg Stock Exchange ("JSE"), and the Official List of the United Kingdom Listing Authority ("UKLA") (collectively, the "Relevant Listing Authorities"). Furthermore, Xstract understands this documentation comprises an ASX Information Memorandum, a JSE pre-listing statement and a UK prospectus (the "Listing Documentation").

The purpose of this report is to provide a technical opinion as to the accuracy and reasonableness of the information supporting ongoing mining and processing operations at Cannington. The focus of the review is on various technical aspects of Cannington Asset: including tenure, geology, Mineral Resources, Ore Reserves, mine plans, production rates, infrastructure, environment, social, capital and operating cost estimates, and principal risks, opportunities and uncertainties. It includes a valuation of Cannington Asset's currently defined Ore Reserves.

This report summarises the findings of Xstract's review and has been prepared in order to satisfy the rules and requirements of the Relevant Listing Authorities, including, in the case of a UKLA listing; the European Securities and Market Authority's ("ESMA") Recommendations on consistent implementation of Commission Regulation ("EC") No 809/2004, implementing the Prospectus Directive (the "ESMA Recommendations", as revised in March 2013). ESMA has taken over, as appropriate, all existing and on-going tasks from the Committee of European Securities Regulators ("CESR") and is the legal successor to CESR. A checklist summarising the requirements for ESMA/CESR is supplied in Appendix A.

Xstract – Excellence from the outset

XstractGroup.com

This report has been prepared in compliance with internationally accepted mineral reporting codes, these being:

- The 2012 Edition of the "Australasian Code for Reporting of Exploration Results, Mineral Resources and Ore Reserves" (the "JORC Code").
- The 2005 Edition of the "Code for the Technical Assessment and Valuation of Mineral and Petroleum Assets and Securities for Independent Expert Reports" (the "VALMIN Code").

The JORC Code establishes the nature of evidence required to report exploration results, Mineral Resources and Ore Reserves in a public document, while the VALMIN Code outlines the key elements to be considered in evaluating and valuing mineral assets and securities. Xstract have included the Cannington Asset Competent Persons JORC code Table 1 for reference purposes in Appendix B.

The Cannington Asset includes an operating mine and processing facility, which are wholly owned and operated by BHP Billiton's subsidiary, BHP Billiton Minerals Pty Ltd ("BHPB Minerals"). The mine lies within the Mount Isa Inlier of northwest Queensland and is situated some 200 km southeast of the regional commercial centre of Mount Isa. The Cannington Operation is forecast to produce up to 3.3 Mtpa with a Life-of-Mine ("LOM") to 2023. The project is discussed in detail in the Competent Person Report.

Xstract is an independent mining consultancy offering expertise in a wide range of resource and engineering disciplines. Xstract has a demonstrated track record in undertaking independent assessments of Mineral Resources/Ore Reserves, due diligence, audits, capital raising reports, and independent feasibility evaluations on behalf of exploration/mining companies and financial institutions worldwide.

This Competent Persons Report has been prepared based on a technical and economic review by a team of consultants sourced from Xstract's staff and associate network over a three-month period. These consultants are specialists in the fields of geology, Mineral Resource and Ore Reserve estimation, open pit mining, rock engineering, mineral processing, hydrogeology, hydrology, tailings management, infrastructure, environmental management and mineral asset valuation.

The individuals listed below have provided input to the Competent Persons Report. Each has extensive experience in the mining industry and are members in good standing of appropriate professional institutions:

- Jeames McKibben, MBA, BSc (Hons), MAusIMM(CP), MAIG, is General Manager – Corporate Advisory with Xstract and has over 20 years' international experience in the mining industry, with significant experience in technical reviews, due diligence assessments and valuation of mineral assets.
- Matthew Readford, MBA, Bsc (Hons), MAusIMM(CP) is a Manager – Geology with Xstract and has over 20 years' experience as a geologist and 6 years as a Management Consultant with significant expertise in Mineral Resource estimation, technical audit and due diligence review.
- Donald Elder, NHD Mineral Resource Management, GDE Mining Engineering, MAusIMM is a Principal Consultant – Mining with Xstract and has over 20 years' experience in the field of Mineral Resource Management, with significant experience in mining operations, feasibility studies and due diligence assessments.
- Richard Price, BEng (Mining) (Hons), MSc (Mineral Economics), MAusIMM is a Principal Consultant – Corporate Advisory with Xstract and has over 12 years' mining and 4 years' investment banking experience, specialising in valuation, due diligence, technical assessment, commodity and jurisdiction analysis and review and feasibility studies.

- Mat Longworth, BSc(Hons), MAusIMM, MAICD is General Manager – Corporate Advisory with Xstract and has over 25 years’ experience across exploration, project evaluation/development, operations and corporate management.
- Tim Horsley, BSc (Hons), MAusIMM is an Associate Consultant – Mining for Xstract with over 36 years’ experience as a mining engineer in both operational and consulting roles.
- Roland Nice, BSc (Met Eng) and FAusIMM, MSME, LMCIMM, MIEA Chartered Eng (Chem) is an Associate Consultant for Xstract and Metallurgical Engineer with RW Nice & Associates Pty Ltd, and has over 45 years international experience as a Metallurgical Engineer both in operations and consulting roles.
- Shaun Barry, BSc (Hons), MSc (MinEcon), MAusIMM is an Associate Consultant – Project Evaluations for Xstract and has over 24 years’ international experience in the minerals industry that includes mining business evaluation, sales, marketing, strategy development and geology.
- Craig Miller, BSc, MSc, PhD, is a member of the International Society of Sustainability Professionals and an Associate Consultant – Environment for Xstract with over 20 years’ experience in ecological research and natural resource management, including ESIA, mine site environmental management and rehabilitation, and due diligence assessments.

Drafts of this report were provided to South32, but only for the purpose of confirming the accuracy of factual material and the reasonableness of assumptions relied upon in the report.

The Listing Documentation contains an appropriate summary of the Cannington Asset, and Xstract is satisfied with the integrity of the information contained in the Listing Documentation based on the limited validation work performed by Xstract.

Xstract has given and not withdrawn its written consent to issue the Listing Documentation with its name included within and to the inclusion of this report and references to this report in the Listing Documentation. Xstract accepts responsibility for the information contained within this report as set out in this section, in the form and context in which the report is included, of the Listing Documentation and those parts of the Listing Documentation, which include references to this report.

Xstract accepts responsibility for this letter and the Competent Persons Report and, to the best of Xstract’s knowledge, having taken all reasonable care to ensure the information contained in its report is in accordance with the facts and contains no omission likely to affect its import.

Yours sincerely

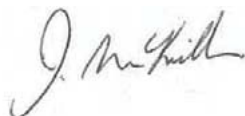

Jeames Kckibben
General Manager & Principal Consultant – Corporate Advisory
Xstract Mining Consultants Pty Ltd

Telephone: +61 7 3221 2366
Fax: +61 7 3221 2235
Email: jmckibben@xstractgroup.com



Cannington Asset, Australia

Competent Persons Report

Prepared for:
South32 Limited
Effective Date: March 2015
FINAL

Xstract Mining Consultants Pty Ltd
ABN: 62 129 791 279

Brisbane, Australia
Ground Level, 545 Queen Street
BRISBANE QLD 4000
PO Box 10312
BRISBANE ADELAIDE STREET QLD 4000
T +61 7 3221 2366 | F +61 7 3221 2235

Perth, Australia
Level 10, 50 St Georges Terrace
PERTH WA 6000
PO Box Z5426
PERTH WA 6831
T +61 8 9327 9500 | F +61 8 9481 8700

Adelaide, Australia
T +61 8 7087 2152
Newcastle, Australia
T +61 61 7 3221 2366
Ulaanbaatar, Mongolia
T +976 7744 0000

London, United Kingdom
T +44 207 002 1012

Internet
www.xstractgroup.com
enquiries@xstractgroup.com

XstractGroup.com

Xstract - Excellence from the outset



Project Manager:

Donald Elder
NHD MRM, GDE Min Eng
MAusIMM
Principal Consultant – Mining
Xstract Mining Consultants, Brisbane

Contributing authors:

J McKibben¹, M Readford², T Horsley³, S Barry⁴, R Price⁵, R Nice⁶, C Miller⁷

Peer review of technical work by:

M Longworth⁸

Report reviewed by:

R Jasen⁹

Client name and address:

South32 Limited
Level 20
Waterfront Place
1 Eagle Street
Brisbane Qld 4000
Australia

Xstract Mining Consultants Pty Ltd has prepared this report on behalf of South32 Limited. Public disclosure, publication, or presentation of any information contained in this document must be accompanied by written consent from Xstract Mining Consultants Pty Ltd.

© Xstract Mining Consultants Pty Ltd 11/03/2015

¹ General Manager & Principal Consultant – Corporate Advisory, Xstract Mining Consultants, Brisbane

² Manager & Principal Consultant – Geology, Xstract Mining Consultants, Brisbane

³ Associate Consultant – Mining, Xstract Mining Consultants, Brisbane

⁴ Associate Consultant – Project Evaluations, Xstract Mining Consultants, Brisbane

⁵ Principal Consultant – Corporate Advisory, Xstract Mining Consultants, Perth

⁶ Associate Consultant – Metallurgical Engineering, RW Nice & Associates Pty Ltd, Sydney

⁷ Associate Consultant – Environment, CTM Consulting Pty Ltd, Brisbane

⁸ General Manager & Principal Consultant – Xstract, Xstract Mining Consultants, Perth

⁹ Technical Editor, Xpert Editorial, Brisbane

XstractGroup.com

Xstract - Excellence from the outset



Document information:

Project reference:	P2085
Reporting standard/s:	JORC Code 2012, VALMIN Code 2005
Effective date:	11 March 2015
Status:	Published
File/version:	
Distributed to:	Ben Armstrong, BHP Billiton
Document format:	Electronic via FTP Site, Microsoft Word Document
Delivered to:	Jim Papageorgiou <jim.papageorgiou@pq-partners.com>

Final approvals/signatures:

	Name, Title, Company	Date	Signature
Authors:	Jeames McKibben General Manager & Principal Consultant – Corporate Advisory	11 March 2015	
	Matthew Readford Manager & Principal Consultant – Geology	11 March 2015	
	Tim Horsley Associate Consultant – Mining	11 March 2015	
	Roland Nice Associate Consultant – Metallurgical Engineering	11 March 2015	
	Craig Miller Associate Consultant – Environmental Engineering	11 March 2015	
Peer Reviewer:	Mathew Longworth General Manager – Xstract	11 March 2015	
Project Manager:	Don Elder Principal Consultant – Mining	11 March 2015	

Xstract Mining Consultants Pty Ltd
ABN: 62 129 791 279

XstractGroup.com

Xstract - Excellence from the outset

Brisbane, Australia
Ground Level, 545 Queen Street
BRISBANE QLD 4000
PO Box 10312
BRISBANE ADELAIDE STREET QLD 4000
T +61 7 3221 2366 | F +61 7 3221 2235

Perth, Australia
Level 10, 50 St Georges Terrace
PERTH WA 6000
PO Box Z5426
PERTH WA 6831
T +61 8 9327 9500 | F +61 8 9481 8700

Adelaide, Australia
T +61 8 7087 2152
Newcastle, Australia
T +61 61 7 3221 2366
Ulaanbaatar, Mongolia
T +976 7744 0000

London, United Kingdom
T +44 207 002 1012
Internet
www.xstractgroup.com
enquiries@xstractgroup.com

Contents

1	Covering letter _____	9
2	Executive summary _____	9
2.1	Key assets	9
2.2	Geological setting	10
2.3	Mineral Resources	10
2.4	Ore Reserves	13
2.5	Mining	14
2.6	Metallurgical processing	15
2.7	Environment	16
2.8	Costs	17
2.9	Market analysis	18
2.10	Regional exploration	19
2.11	Risks and opportunities	20
2.12	Valuation	22
3	Introduction _____	23
3.1	Background	23
3.2	Review process	23
3.3	Structure	25
3.4	Compliance	25
3.5	Data sources	26
3.6	Competent Persons and Experts statement	26
3.7	Reliance statements	27
3.8	Independence, disclaimer and warranty	28
4	Cannington Asset _____	30
4.1	Introduction	30
4.2	Location, access and local Resources	32
4.3	Climate, physiography and land use	34
4.4	Ownership and tenure	35
4.5	History	38
4.6	Geological setting	41
4.7	Mineral Resource and Ore Reserve statements	47
4.8	Mining	56
4.9	Processing	59
4.10	Equipment and manning	69
4.11	Management and Industrial Relations	71

4.12	Health and Safety	71
4.13	Infrastructure	72
4.14	Transportation	72
4.15	Explosives management	73
4.16	Marketing	73
4.17	Environment and social	74
4.18	Cost assumptions	82
4.19	Risk and opportunities	87
5	Regional exploration assets _____	90
5.1	Introduction	90
5.2	Southern Domain Project	92
5.3	Cannington Near Environs Project	93
5.4	Soldiers Cap Joint Venture Project	93
5.5	Cloncurry Project	94
5.6	Regional	94
5.7	Exploration expenditure	94
6	Special factors _____	95
6.1	Adjacent projects	95
7	Market analysis _____	95
7.1	Lead	96
7.2	Zinc	96
7.3	Silver	97
7.4	Price analysis	97
8	Valuation of Ore Reserves _____	99
8.1	Introduction	99
8.2	Valuation methodology	99
8.3	Discounted cash flow	100
8.4	Market support	110
8.5	Valuation summary	113
9	Concluding remarks _____	113
10	Consultant qualifications and experience _____	114
11	References _____	117

Tables

Table 2.1:	Cannington Mineral Resource as at 30 June 2014 in 100 per cent terms	11
Table 2.2:	Cannington Mineral Resource as at 31 December 2014 in 100 per cent terms	11
Table 2.3:	Cannington Ore Reserve as at 30 June 2014 in 100 per cent terms	13



Table 2.4: Cannington Ore Reserve as at 31 December 2014 in 100 per cent terms	13
Table 2.5: Cannington Operations – Capital Cost estimate (real)	17
Table 2.6: Cannington Operations – Operating Cost estimate (real)	18
Table 2.7: Actual and Forecast Exploration Expenditure (AUD M) – FYs 2012 to 2017	20
Table 2.8: Summary Valuation of Cannington Ore Reserves	22
Table 2.9: Assigned Value to the Cannington Ore Reserves in 100 per cent terms	23
Table 3.1: Summary of Xstract’s site visits	25
Table 3.2: Consultant shareholdings in BHP Billiton as at 16 January 2015	29
Table 4.1: Cannington Asset exploration and mining tenements (October 2014)	36
Table 4.2: Cannington Asset’s production since commissioning	40
Table 4.3: Cannington Mineral Resource as at 30 June 2014 in 100 per cent terms	48
Table 4.4: Cannington Mineral Resource as at 31 December 2014 in 100 per cent terms	49
Table 4.5: Number and type of drillholes used for the FY14 Mineral Resource estimate	50
Table 4.6: Drill spacing criteria for Mineral Resource Classification	53
Table 4.7: Cannington Ore Reserve as at 30 June 2014 in 100 per cent terms	54
Table 4.8: Cannington Ore Reserve as at 31 December 2014 in 100 per cent terms	54
Table 4.9: Mine operating statistics including Inferred Resources	57
Table 4.10: Cannington Operations Mine production forecast excluding Inferred Resource	59
Table 4.11: Process plant historical performance – FY2010 to Q1 2015	63
Table 4.12: Process plant forecast performance – FYs 2016 to 2023	66
Table 4.13: Process plant reagents	67
Table 4.14: Cannington Operations Underground mining fleet	70
Table 4.15: Cannington Operations workforce numbers – actual and forecast	71
Table 4.16: Power breakdown by generator type	72
Table 4.17: Summary of risk and likelihood assessment conducted for Closure Plan 2014	90
Table 5.1: Actual and Forecast Exploration Expenditure (AUD M) – FYs 2012 to 2017	95
Table 8.1: Valuation approaches for different types of mineral assets	100
Table 8.2: Financial model production statistics	101
Table 8.3: Inflation and exchange rate forecast	101
Table 8.4: Forecast metal price, treatment charges and refining charges	102
Table 8.5: Operating cost summary	105
Table 8.6: Summary of sustaining capital expenditure	106
Table 8.7: Cost of equity (nominal)	107
Table 8.8: Summary of the valuation of Cannington Asset’s Ore Reserves on 100 per cent terms	107
Table 8.9: Comparable Market Transactions	112
Table 8.10: Assigned Value to the Cannington Ore Reserves	113

Figures

Figure 4.1: Holding structure	31
Figure 4.2: Administrative structure of Cannington Asset	31
Figure 4.3: Location of the Cannington Operations	32
Figure 4.4: Simplified geological framework of the Mount Isa Inlier	42
Figure 4.5: Interpreted geology at 900 mRL (350 m below surface)	44
Figure 4.6: Interpreted geology section of the Southern Zone at 4700 mN looking north	45
Figure 4.7: Interpreted geology section of the Northern Zone at 5300 mN looking north	46
Figure 4.8: Mineralisation styles and trends nomogram	47
Figure 4.9: Cannington Ore Reserve History 2010 to 2014	55
Figure 4.10: Schematic Long-section of Cannington Operations Underground Mine	56
Figure 4.11: Mine production forecast	58
Figure 4.12: Cannington Operations ore treatment process flowsheet	61
Figure 4.13: Cannington Operations Ore Treatment Talc Pre-Float Flowsheet	62
Figure 4.14: Cannington Operations historical head grades	64
Figure 4.15: Cannington Operations Head Grades – 2010 to 2015 (Historical) and 2016 to 2023 (Forecast)	65
Figure 4.16: Cannington Operations LOM Tailings Storage Facilities Layout	69
Figure 4.17: Mining Forecast Capital Expenditure – FYs 2016 to 2023 (Nominal)	83
Figure 4.18: Processing Forecast Capital Expenditure – 2015 to 2023 (Nominal)	83
Figure 4.19: Mining Forecast Operating Expenditure – FYs 2016 to 2023	84
Figure 4.20: Processing Forecast Operating Costs – FYs Q2 2015 to 2023	84
Figure 4.21: Concentrate Transport Forecast Operating Costs – FYs Q2 2015 to 2023	85
Figure 4.22: Concentrate Shipping Forecast Operating Costs (AUD M) – FYs Q2 2015 to 2023	86
Figure 4.23: General and Administration Forecast Operating Costs – FYs Q2 2015 to 2023	87
Figure 5.1: Location of BHPB Minerals' regional exploration permits	91
Figure 7.1: Consensus forecast metal prices	98
Figure 7.2: Forecast lead and zinc treatment charges and silver refining charge	99
Figure 8.1: Revenue by payable metal (excluding TC/RC)	103
Figure 8.2: Mining costs	104
Figure 8.3: Operating cost profile	105
Figure 8.4: Cash Flow of scheduled Ore Reserves	108
Figure 8.5: Sensitivity of NPV	110

Appendices

Appendix A: ESMA/CESR Compliance Checklist

Appendix B: JORC 2012 Table 1



Key abbreviations

%	Per cent
°	degrees of angle
°C	Degrees Celsius
AAS	Atomic Absorption Spectrometry
Ag	Silver
AG	Autogenous grinding
AIG	Australian Institute of Geoscientists
ANCOLD	Australian National Committee of Large Dams
AS	Australian Standard
ASIC	Australian Securities and Investment Commission
ASX	Australian Securities Exchange
AUD	Australian dollars
Aurizon	Aurizon Holdings Limited, an ASX listed rail company
AusIMM	Australasian Institute of Mining and Metallurgy
BHP Billiton	BHP Billiton Limited and/or BHP Billiton Plc
BHPB Cannington	BHP Billiton Cannington Pty Ltd, a subsidiary company of BHP Billiton
BHPB Minerals	BHP Billiton Minerals Pty Ltd, a subsidiary company of BHP Billiton
BHT	Broken Hill Type, a lead-zinc silver mineralisation type
BIF	Banded Iron Formation, layered ironstone unit
Bn	billion
Cannington Asset	The Cannington mining operations, rail, port and administrative infrastructure
Cannington Operations	The Cannington silver-lead-zinc mining and processing facilities
CAPM	Capital asset pricing model
CCDF	Cannington Community Development Fund
CDMP	Community Development Management Plan
CESR	Committee of European Securities Regulators
CEZA	Crusher Exclusion Zone Access
CHMP	Cultural Heritage Management Plan
CIMVAL	The Canadian 2003 Edition of the Standards and Guidelines for Valuation of Mineral Properties
Company	BHP Billiton Cannington Pty Ltd
CP	Chartered Professional, designation of the AusIMM
CPI	Consumer Price Index
CRM	Certified Reference Material
DCF	Discounted cash flow
DEHP	Department of Environment and Heritage Protection
DERM	Department of Environment and Resource Management
dmt	Dry metric tonne(s)

DNRM	Department of Natural Resources and Mines
dol_bee	Price protocol
DTM	Digital Terrain Model
EA	Environmental Authority
EC	Environmental Consent
EDL	Energy Developments Limited, an energy company
EIA	Environmental Impact Assessment
EMOS	Environmental Management Overview Strategy
EMP	Environmental Management Plan
EP	Equator Principles
EPBC Act	<i>Environmental Management and Biodiversity Conservation Act 1999</i>
EPFI	Equator Principles Financial Institutions
EPM	Exploration Permit for Minerals other than Coal
ERA	Environmentally relevant activities
ESIA	Environmental and Social Impact assessment
ESMA	European Securities and Market Authority
ESMP	Environmental and Social Management Plan
ESMS	Environmental and Social Management System
Exco	Exco Resources Limited
F	fluorine
FCA	Financial Conduct Authority of the UKLA
FEL	Front-end loader
FIFO	Fly-in, fly-out
FMV	Fair market value
FOB	Free on board ship
FPIC	Free, Prior and Informed Consent
FTE	Full time equivalent
FY	Financial year (1 July to 30 June)
g	Gram(s)
G&A	General & Administration
GAB	Great Artesian Basin
GHG	Greenhouse gas
GLD	Group Level Documents
HAT	Highest astronomical tide
IAS	Initial Advice Statement
ICP-OES	Inductively Coupled Plasma – Optical Emission Spectrometry, a geochemical assay technique
IFC	International Finance Corporation
ILUA	Indigenous Land Use Agreement
Intierra	IntierraRMG, a mining and exploration project oriented database
IP	Intellectual property

JORC Code	The 2004 Edition of the Australasian Code for Reporting of Exploration Results, Mineral Resources and Ore Reserves
JSE	Johannesburg Stock Exchange
JV	Joint Venture
km	Kilometre(s)
km ²	Square kilometre(s)
koz	Kilo-ounce(s)
KPI	Key performance indicator
kt	Kilotonne(s)
KW	Kilowatts, a measure of energy, can be divided into eKW (electrical) and tKW (heat)
lb	Pound(s)
LHD	Load-haul dumper
LME	London Metals Exchange
LOA	Life of Asset
LOM	Life-of-Mine
LOR	Life of Reserve
LSE	London Stock Exchange
m	Metre(s)
M	Million(s)
m ³	Cubic metre(s)
Ma	Million years ago
CPR	Competent Persons Report
MIBC	Methyl isobutyl carbinol
MI	Mega litres
ML	Mining Lease
mm	Millimetre(s)
mN	Metres North
MNES	Matters of National Environmental Significance
Mt	Million metric tonnes
Mtpa	Million metric tonnes per annum
MW	Megawatts, a measure of energy, see KW above
NPV	Net present value
NSR	Net Smelter Return
OK	Ordinary Kriging
Orica	Orica Limited, an explosives manufacturing company
oz	ounces
Pb	Lead
PDS	Proximity Detection System
PLCs	Programmable logic controllers
PPE	Personal protective equipment
QA/QC	Quality assurance – quality

RC	Refining Charge
Redpath	Redpath Australia Pty Limited, Mining contractors and engineers
ROM	Run-of-Mine
RPO	Recognised Professional Organisations
RQD	Rock quality designation
SAMVAL	The South African Code for the Reporting of Mineral Asset Valuation
SEIS	Supplementary Environmental Impact Statement
SG	Specific gravity
SNL	SNL Limited, a mining project oriented database
South32	South32 Limited, the new entity to be demerged from BHP Billiton
SRCE	Standard Reclamation Cost Estimator
t	Metric tonne(s)
TC	Treatment Charges
toz	Troy ounces
tpa	Metric tonnes per annum
TRIF	Total Recordable Incident Frequency
TSF	Tailings Storage Facility
TSFE2	Tailings Storage Facility Expansion 2
UKLA	United Kingdom Listing Authority
USD	United States Dollars
VALMIN Code	The 2005 edition of the Code for the Technical Assessment and Valuation of Mineral and Petroleum Assets and Securities for Independent Expert Reports
Vertimill	Vertical ball mill
WACC	Weighted Average Cost of Capital
wmt	Wet metric tonne(s)
XRF	X-ray fluorescence, a geochemical assay technique
Xstract	Xstract Mining Consultants Pty Ltd
YTD	Year to date
Zn	Zinc

1 Covering letter

Please refer to the covering letter at the beginning of this document.

2 Executive summary

The directors of South32 Limited ("South32") have commissioned Xstract Mining Consultants Pty Ltd ("Xstract") to prepare a Competent Persons Report on the Cannington silver-lead-zinc mining operations, located in northwest Queensland, Australia. The Cannington Asset is owned and operated by BHP Billiton Minerals Pty Ltd ("BHPB Minerals"), which is a wholly-owned subsidiary of BHP Billiton Limited ("BHP Billiton").

It is understood that the Cannington Asset is to be demerged from BHP Billiton, along with certain other aluminium, coal, manganese, and nickel assets, into a new corporate entity, South32. Simultaneously, South32 will seek a listing on the Australian Securities Exchange ("ASX"), the Johannesburg Stock Exchange ("JSE"), and on the Official List of the United Kingdom Listing Authority ("UKLA"), in order to trade on the Main Board of the London Stock Exchange ("LSE").

This report provides a technical account of the Cannington mining and processing operations ("Cannington Operations"), associated rail, port and administrative infrastructure and related regional exploration assets (collectively, the "Cannington Asset"). It compiles currently available and material information to assist potential investors in South32 make a reasoned judgement regarding the techno-economic merits of the Cannington Asset. The focus of this report is on the technical aspects of the Cannington Asset: including tenure, geology, Mineral Resource and Ore Reserve statements, mine plans, production rates, infrastructure, environment and social, capital and operating cost estimates, and principal risks, opportunities and uncertainties. It includes a valuation of the currently defined Ore Reserves held by the Cannington Asset.

This report has been prepared by Competent Persons in accordance to the 2012 Australasian Code for Reporting of Exploration Results, Mineral Resources and Ore Reserves ("JORC Code") and 2005 Code for the Technical Assessment and Valuation of Mineral Assets and Securities in Independent Expert Reports ("VALMIN Code") to comply with the rules and requirements of the European Securities and Markets Authority's Recommendations on consistent implementation of Commission Regulation ("EC") No 809/2004 implementing the Prospectus Directive (the "ESMA Recommendations").

The effective date of this Competent Persons Report is 11 March 2015. All monetary values outlined in this report are expressed in United States Dollars ("USD") or Australian Dollars ("AUD"), unless otherwise stated.

2.1 Key assets

The Cannington Asset is an integrated underground mining and metallurgical processing facility located approximately 135 km southeast of Cloncurry in the Mount Isa Inlier of northwest Queensland, Australia. The Cannington Operation is currently one of the world's largest and lowest cost producers of silver, lead and zinc concentrates, with a nominal processing capacity of over 3.2 million tonnes per annum ("Mtpa"). Major aspects of the operation including underground mining, ore processing, tailings management, waste rock, stormwater drainage and storage, transport, water supply, power and waste management.

The key assets discussed in this report comprise:

- A 100 per cent interest in the Cannington Operations and associated infrastructure including a nearby borefield, the Yurbi rail siding and ship loading facilities at Townsville port (collectively known as the “Cannington Asset” and a material mineral project for this valuation), and
- Various brownfield and greenfield exploration properties located to the north and south of the Cannington Operations and covering a combined area of approximately 1,646 km².

The Cannington Asset’s mineral interests comprise three granted mining leases (“ML”) and 13 granted Exploration Permits for Minerals other than Coal (“EPM”). All are currently held in the name of BHPB Minerals, and are planned to be transferred to BHP Billiton Cannington Pty Ltd (“BHPB Cannington”) prior to the demerger, in order to isolate the Cannington Asset from other BHP Billiton Assets, also held by BHPB Minerals.

In addition to its granted MLs, BHPB Minerals holds associated authorisations, permits and licences over all operational areas.

While Xextract do not consider the regional exploration assets to be material in terms of the overall value assigned to Cannington Asset, they provide further growth options going forward and hence for completeness are summarised briefly within this report.

2.2 Geological setting

The Cannington silver-lead-zinc deposit lies along the southeastern margin of the Eastern Succession of the Proterozoic Mount Isa Inlier of northwest Queensland. The known mineralisation is hosted within high-grade metamorphic rocks (comprising garnetiferous psammite, migmatitic gneiss and amphibolite) of the Soldiers Cap Group, which have been folded about a tight isoclinal recumbent synform, which plunges to the south. These units are buried beneath 60 m of flat-lying Mesozoic sediments.

Mineralisation is stratiform along the limbs of the recumbent synform and is divided into two main zones, namely the Southern Zone and the Northern Block, by the northwest-southeast trending, steeply northeast dipping Trepell Fault. Based on textural, mineralogical and geochemical characteristics the mineralisation is further divided into footwall (western limb) and hangingwall (eastern limb) lead-rich and zinc rich lodes. An additional ore type is defined in and around the fold nose. Within each of these, the mineralisation is further divided into either a more mafic host or a more siliceous host.

The sulphide mineralogy of the silver-lead-zinc mineralisation is dominated by coarse grained galena (PbS), sphalerite (ZnS) and fribergite (Cu₆(Ag, Fe)₆Sb₄S₁₃). Silver is predominantly contained in fribergite but also occurs in galena and other silver mineral species. Sphalerite is typically coarse grained. Other sulphide minerals include pyrite, pyrrhotite, chalcopyrite and arsenopyrite.

2.3 Mineral Resources

The Mineral Resources for the Cannington Operations are reported inclusive of Ore Reserves.

The Mineral Resources as stated in Table 2.1 are as at 30 June 2014 and in accordance with the terms and definitions of the JORC Code. The stated Mineral Resources have also been depleted to account for actual production until 30 October 2014 and forecast production from 1 November to 31 December 2014. The Mineral Resources as at 31 December 2014 are presented in Table 2.2.

Table 2.1: Cannington Mineral Resource as at 30 June 2014 in 100 per cent terms

Open Pit	Tonnes (Mt)	Silver (g/t)	Lead (%)	Zinc (%)
Measured	13	93	3.80	2.26
Indicated	7	64	2.76	1.96
Measured + Indicated	20	83	3.43	2.16
Inferred	-	-	-	-
Total	20	83	3.43	2.16

Cut-off AUD45/dry metric tonne - Dolbee

Underground	Tonnes (Mt)	Silver (g/t)	Lead (%)	Zinc (%)
Measured	44	226	6.20	3.82
Indicated	12	148	4.51	3.04
Measured + Indicated	56	209	5.84	3.65
Inferred	7	100	3.56	2.02
Total	63	198	5.61	3.48

Cut-off AUD90/dry metric tonne - Dolbee

Combined	Tonnes (Mt)	Silver (g/t)	Lead (%)	Zinc (%)
Measured	57	196	5.65	3.46
Indicated	19	117	3.87	2.64
Measured + Indicated	76	176	5.21	3.26
Inferred	7	100	3.56	2.02
Total	83	170	5.07	3.15

Source: BHPB Minerals

Table 2.2: Cannington Mineral Resource as at 31 December 2014 in 100 per cent terms

Open Pit	Tonnes (Mt)	Silver (g/t)	Lead (%)	Zinc (%)
Measured	13	93	3.80	2.26
Indicated	7	64	2.76	1.96
Measured + Indicated	20	83	3.43	2.16
Inferred	-	-	-	-
Total	20	83	3.43	2.16

Cut-off AUD45/dry metric tonne - Dolbee

Underground	Tonnes (Mt)	Silver (g/t)	Lead (%)	Zinc (%)
Measured	43	225	6.20	3.84
Indicated	12	147	4.50	3.04
Measured + Indicated	55	208	5.83	3.67
Inferred	7	99	3.55	2.01
Total	61	197	5.57	3.49

Cut-off AUD90/dry metric tonne - Dolbee

Combined	Tonnes (Mt)	Silver (g/t)	Lead (%)	Zinc (%)
Measured	56	194	5.64	3.47
Indicated	19	116	3.86	2.64
Measured + Indicated	75	175	5.19	3.26
Inferred	7	99	3.55	2.01
Total	82	168	5.05	3.16

Source: BHPB Minerals

The Mineral Resource estimate meets the criteria for reasonable prospects for eventual economic extraction through the application of a cut-off value applied to an estimate of the in-situ value of the contained metal at the mine gate after distribution, treatment, refining and royalty costs have been deducted. Reporting cut-off values essentially reflect mining, haulage, processing and general and administrative costs, that is then inflated to cover the risk of possible commodity price falls, and which, for open pit and underground methods, are AUD45 per dry metric tonne ("dmt") and AUD90/dmt, respectively. Xstract is satisfied that the estimate is representative of the Mineral Resource for the Cannington Asset.

The Mineral Resource estimate is based on 6,470 drill holes completed between 1990 and 2011, of which 85 per cent is underground diamond drilling. The geological, grade and density data sourced from drill holes is considered by Xstract to be suitable for use in developing the Mineral Resource estimate. The sample and assay quality assurance and quality control procedures are also appropriate for ensuring the precision and accuracy of the assay results that support the Mineral Resource estimation.

The geological model is constructed from predominantly 12.5 m spaced sectional interpretations of drilling and is based on lithological-structural, grade and geometallurgical criteria. Block modelling resolution is adequate for accurate estimation of geological volumes. The grade continuity analysis is not presented in sufficient detail for Xstract to evaluate the quality of grade estimation inputs so greater emphasis has been placed on evaluating the quality of grade estimation through historical mining reconciliation. In general, global mean comparisons between sample and model block grades compare better in the higher grade domains than in the lower grade domains. Past audits have identified the potential for block density to be underestimated in areas of extreme grades. However, supporting documentation for derivation of density estimation formulae is unavailable for review.

The Mineral Resource classification is based primarily on the spacing of drill sampling criteria that varies for resources amenable to extraction by underground and open pit

methods. The data density and level of detail in the geological modelling suggests that the Mineral Resource classification may be conservative.

Overall, the detail of geological knowledge and high density of sample data is expected to compensate for a simplistic grade estimation approach. Annual reconciliation of the model with mill feed and concentrate production are typically within 10 per cent and support the conclusion that Measured Resources provide a reasonable basis for prediction of Ore Reserves on an annual production basis.

The inclusion of an additional 700 drill holes into future Mineral Resource estimates, improvement of grade estimation and block size modelling to facilitate Ore Reserve and mining selectivity optimisation, and integration of geological and grade continuity with Mineral Resource classification all represent significant opportunities for Cannington Asset to increase the size and quality of the Cannington Mineral Resource estimate.

The structural repetition of Cannington mineralisation in the Northern and Southern Zones provides reasonable support for the existence of additional mineralisation both along strike from faulting and across strike from folding. Based on some small areas of mining and positive results from limited drill testing, the area south of the Hamilton fault, and possibly at a greater depth than the Southern Zone, appears to be the most prospective.

2.4 Ore Reserves

A summary of the Ore Reserves for the Cannington Operations as at 30 June 2014 is set out in Table 2.3. The stated Ore Reserves have been depleted to account for actual production until 30 October 2014 and forecast production from 1 November to 31 December 2014. The Ore Reserves as at 31 December 2014 are presented in Table 2.4.

The estimate for the mineable tonnes in-situ has been depleted according to validated depletion figures received from Cannington Asset. Thereafter the publicly available modifying factors have been applied.

All reported Ore Reserves are derived from the underground Mineral Resources. To date, no open pit Ore Reserves have been estimated.

Table 2.3: Cannington Ore Reserve as at 30 June 2014 in 100 per cent terms

Ore type	Proved Ore Reserve				Probable Ore Reserve				Total Ore Reserve			
	Tonnes (Mt)	Silver (g/t)	Lead (%)	Zinc (%)	Tonnes (Mt)	Silver (g/t)	Lead (%)	Zinc (%)	Tonnes (Mt)	Silver (g/t)	Lead (%)	Zinc (%)
Sulphide	18	239	6.38	3.92	2.7	240	6.15	4.01	21	239	6.35	3.93

Source: BHPB Minerals

Table 2.4: Cannington Ore Reserve as at 31 December 2014 in 100 per cent terms

Ore type	Proved Ore Reserve				Probable Ore Reserve				Total Ore Reserve			
	Tonnes (Mt)	Silver (g/t)	Lead (%)	Zinc (%)	Tonnes (Mt)	Silver (g/t)	Lead (%)	Zinc (%)	Tonnes (Mt)	Silver (g/t)	Lead (%)	Zinc (%)
Sulphide	17	237	6.31	3.94	2.6	240	6.13	4.02	20	237	6.29	3.95

Source: BHPB Minerals

The Ore Reserve estimates are based on an underground open stopping (with cemented backfill) mining method that has been employed since mining commenced at Cannington Operations in 1997. A NSR cut-off grade of AUD140/t has been applied to define ore.

In Xstract's opinion, the Ore Reserve estimate has been compiled in accordance with the JORC Code and is based on realistic and practical assumptions. Cannington Operations' mine plan aims to maximise the asset value (in NPV terms) and is reflected in the cut-off grades applied. The cut-off grades are regularly reviewed and optimised with respect to the Life-of-Mine ("LOM") plan.

The mine plan schedules an additional 6 Mt yet to be classified as an Ore Reserve. In Xstract's opinion, it would be reasonable to assume that this will be converted to an Ore Reserve in due course. Opportunities for further material additions to the underground Ore Reserve would be limited to relaxing the cut-off grades.

A number of open pit studies have previously been carried out. Any potential open pit would likely target the shallower low-grade ore above the North Zone and extend to depth over the Southern Zone chasing high remnant ore grade as assumed metal prices are increased. At current price forecasts no open pit is included in the mine plan, however, the potential exists if there is a material increase in metal prices (particularly for silver).

2.5 Mining

2.5.1 Mining methods and access

The Cannington Asset has been operational since 1997, with underground mining currently carried out using conventional long-hole sub-level open stope with cemented backfill. Mining extends from the Southern Zone workings into the Northern Zone mineralisation with the workings measuring 1.2 km (north-south) by 0.6 km to a depth of 650 m below surface.

The mine is accessed via a single surface portal with a ramp system extending to a depth of about 600 m into the Southern Zone of the deposit. The stoping areas are accessed by sub-levels developed on a nominal 25 m vertical interval.

A number of ore passes, developed in ore, feed to a crusher loading level. Approximately two-thirds of the ore is crushed underground at the underground crushing station located at the base of the mining operation and hoisted to the surface. A 5.6 m diameter hoisting shaft extends to a depth of 650 m and is equipped with a tower mounted friction winder.

The balance of the ore is hauled directly to the surface via decline access, passes through a crushing plant and is stockpiled on the run-of-mine ("ROM") ore stockpile.

Mining exclusion zones have been delineated around the crusher, shaft and access infrastructure. Provision has been made in the mine plan for a replacement crusher to allow extraction of high-grade ore within the crusher exclusion zone in 2018.

Once stopes have been completely mined, they are backfilled with waste rock or paste. Paste fill is delivered from the paste plant to the underground workings for distribution via a conveyor system or a series of pipes, depending on the area to be backfilled. The paste backfill provides stability to the underground workings and allows ore beside the backfilled void to be extracted.

The Cannington Operation uses an underground production fleet of trucks and load haul dump ("LHD") units, with all underground mining machinery and equipment serviced in an underground workshop.

2.5.2 Production schedule

The underground mine is at a mature stage of its life, having undergone a number of expansions from the 1.5 Mtpa design capacity at start-up (1997) through to the current 3.4 Mtpa capacity. The mine is planned to operate at close to current production levels

until depletion. Mined ore grades and production rates are expected to decline in the final two to three years.

The current mine plan includes 6 Mt yet to be classified as an Ore Reserve. The bulk of this (5 Mt) is accounted for in two satellite blocks in the North Zone adjacent to the current workings. These are currently under evaluation and contain greater than 80 per cent Measured and Indicated Resource.

2.6 Metallurgical processing

The Cannington Operations processing plant is a mature operation and uses conventional crushing, grinding flotation and dewatering practices. Processing involves grinding through a mill with sequential lead-zinc flotation and a concentrate leaching process to liberate a zinc concentrate and a silver-rich lead concentrate. Tailings are thickened and deposited in the Tailings Storage Facility ("TSF"), or mixed with cement for deposition into underground voids as paste fill. Approximately 3.5 Mt of ore is processed annually, resulting in the production of approximately 500,000 tonnes per annum ("tpa") of high-grade marketable concentrates, and 3 Mtpa of process tailings residue.

The Cannington Operations are unique as it contains high quality lead and zinc head grades as well as very high silver grades. As a result, the Cannington Asset produces an excellent lead concentrate at almost 70 per cent Pb along with over 2,300 g/t Ag (about 74 oz/t). Cannington Operations' zinc concentrate is of moderate zinc quality at 47 per cent Zn to 50 per cent Zn and contains about 265 g/t Ag.

The LOM forecast has lead concentrates steady at 70 per cent Pb and Ag grades slowly falling from 2,600 g/t to 2,300 g/t. The forecast zinc concentrates are steady at 50 per cent Zn with Ag grades dropping from 131 g/t to 110 g/t. The head grades for forecast production decline steadily, especially for Pb, from 6.0 per cent to 5.5 per cent compared with historical grades of 9.5 per cent Pb to 7.0 per cent Pb. Silver is also forecast to fall from 230 g/t to 165 g/t, compared against the preceding five years where Ag dropped from 450 g/t to 290 g/t. Zinc grades also declined during the same preceding five-year period but not to the same extent as silver. Going forward, zinc grades are forecast to fall from about 4.4 per cent Zn to 3.0 per cent Zn. These declining head grade trends may impact metallurgical recoveries and concentrate grades.

There are some innovative approaches in the Cannington Operations process flowsheet primarily used to reduce the amount of fluorine that reports to the lead and zinc concentrates. The first approach is to use a talc pre-float step, which removes a significant amount of the talc mineral which is associated with fluorine. The second step is to reduce the fluorine in the final concentrates by leaching with aluminium sulphate.

The Cannington Operations plant incorporates a split primary lead flotation using a hydrocyclone. The fines from the hydrocyclone are treated in a rougher and cleaner circuit, while coarser material from the hydrocyclone is reground and treated in a rougher/cleaner circuit. Tailings from the lead circuit are fed to the zinc circuit. Zinc final tailings along with the pre-float talc concentrates are thickened and then sent to a paste backfill plant that prepares the tailings material to be sent underground as backfill for the mined out stopes. The excess from the paste plant is then pumped to a tailings storage facility ("TSF"). Water from this TSF is returned for re-use in the plant. Other plant and site waste waters are sent to the TSF. The currently used TSF cell is capable of being expanded by lifting the walls at least once and perhaps twice. In addition, the construction of Cell 3 has been completed and is ready for use. There are provisions to install, if necessary two more cells; Cell 4 and Cell 5. At the TSF site, there is a TSF decant storage pond and a pond dedicated to receive the fluorine leach liquor. This pond serves as an evaporation pond.

Concentrates are leached using aluminium sulphate to remove fluorine. The leached product is then filtered in separate belt filters to produce a Pb concentrate at about 7.5 per cent moisture suitable for shipping and a Zn concentrate at about 9.5 per cent moisture ready for shipment.

2.6.1 Materials handling

In addition to the underground mining and associated metallurgical processing facilities, the Cannington Operations relies on other BHP Billiton-owned and operated infrastructure including a rail-loading facility located at Yurbi, 15 km southeast of Cloncurry, and a ship-loading facility in Townsville, some 750 km to the east. Concentrate is either trucked direct to customers (principally Mount Isa) or to the Yurbi railhead, where it is loaded onto covered train wagons for transport to the Townsville port facility or customer facilities.

Concentrate shipment is conducted by contractors and entails loading into special covered side-tip truck wagons which freight the concentrates to the Yurbi rail load out. At Yurbi, the concentrates are loaded into covered wagons and railed to the port of Townsville. Once at the port, concentrate is unloaded, stored, and loaded onto ships at a purpose-built wharf and ship-loader. Once a suitable amount of concentrate has been stockpiled, it is loaded onto ships for export.

Reagents and consumables are all imported to site by truck and stored undercover awaiting use in the plant and mine. Various mixing systems have been set up to allow preparation of the reagents into liquid and slurry form ready for distribution into the plant as required.

2.6.2 Infrastructure

Electric power is provided to the Cannington Operations site using a gas fired generating plant owned and operated by third parties. The plant comprises 26 medium-speed rotary engines using gas with four stand-by diesel fuelled engines. In total, there is a generating capacity of 40 MW.

Water is provided to the processing operation primarily as recycled water from the TSF and internal plant thickener recycling. Raw water is provided from Cannington Asset's borefield. The extraction rate is lower than the licence allows and consumption is expected to continue to be below allowable extraction rates.

2.7 Environment

The Cannington Mine is subject to Commonwealth and State Government environmental laws, regulations, and policies. Queensland Environmental Authority ("EA") #190027 was issued prior to mining commencing in 1996, as per Queensland's *Environmental Protection Act 1994*. The EA has been amended periodically, with the most recent EA (EPML00897513) issued to take effect 26 June 2014. The EA establishes limits on emissions to water, land, and air, from mining and from the eventual rehabilitated site, and incorporates all permits required under law.

EA EPPR00932913 for the Townsville port facility was issued under the *Sustainable Planning Act 2009*, and deals with stormwater management and the potential discharge of polluted stormwater into the harbour. BHP Billiton expects that its subsidiaries, such as BHPB Minerals, will "demonstrate environmental responsibility by minimising environmental impacts and contributing to enduring benefits to biodiversity, ecosystems and other environmental resources".

The ML area occurs in a hot semi-arid environment. Mitchell grassland (*Astrebla sp.*) and sparse Gidgee woodlands (*Acacia cambagei*) are the predominant vegetation types within

the mine area, while Coolabah (*Eucalyptus coolabah*) and River Red Gum (*E. camaldulensis*) dominate the riparian margins. All of the vegetation types and constituent species are widespread and common and are not of conservation significance or of concern. The sparse vegetation supports a diverse assemblage of terrestrial fauna, with 283 species recorded, although the habitats associated with the ML are well represented in the local area and do not require special attention. Cannington Mine does not affect Matters of National Environmental Significance listed in the *Environmental Management and Biodiversity Conservation Act 1999*.

The mine is largely underground, and the operational footprint above ground (including the accommodation village, TSF, ROM pad, and processing infrastructure) is kept as small as possible. This has minimised land disturbance and vegetation clearance, and the majority of the post-mine area will be able to be rehabilitated back to the original ecological condition and economic function. The exceptions will be the TSF and the entrance to the mine.

The Cannington Asset supports community programs to improve socio-economic conditions in the area through the Cannington Community Development Fund ("CCDF"), established in 2006. Priority areas for investment are projects that will provide lasting benefit in the areas of health and safety, education, environment, the arts, and sport and recreation. The focus of the CCDF is the Shires of McKinlay and Cloncurry, and the City of Townsville in order to achieve greatest impact from community development activities. Independent surveys have found that the Cannington Mine is generally well regarded and that their community efforts are appreciated.

Cultural Heritage Management Plans consistent with the *Aboriginal Cultural Heritage Act 2003* have been developed in consultation with traditional owners from the Yulluna and Mitakoodi Peoples.

2.8 Costs

2.8.1 Capital cost estimate

The total capital requirement for Cannington Operations is summarised in Table 2.5. These costs are associated with removing the crusher from the underground, TSF Cell 2 uplift and Cells 4 and 5 construction and capital development.

Table 2.5: Cannington Operations – Capital Cost estimate (real)

Item (USD M)	FY15 H2	FY16	FY17	FY18	FY19	FY20 - beyond
Underground mining equipment	4.4	10.7	10.8	9.0	11.6	30.3
Mining Development	4.0	9.8	10.6	10.1	8.1	17.1
Crusher	-	-	10.2	35.7	-	-
Maintenance and engineering	5.5	13.7	23.2	9.9	19.1	41.4
Processing	11.6	2.0	1.3	0.9	1.8	18.6
Other	2.7	5.7	5.9	9.4	8.4	14.0
Total	28.1	41.9	62.0	74.9	49.2	121.4

Source: BHPB Minerals, Xstract estimate

2.8.2 Operating cost estimate

The total operating costs for the Cannington Operations as forecast by the Cannington Asset on a LOA basis are summarised in Table 2.6.

The main components of the mining operating costs include labour (43 per cent of total mining costs), development and production (22 per cent combined), backfill (12 per cent), ore handling costs, maintenance and other.

The major component of operating costs in the plant is power consumption accounting for some 32 per cent of the total cost. Hence, operating costs are quite sensitive to the changes in fuel costs. Overall, plant fixed costs are 25.5 per cent of total plant operating costs.

The Cannington site accounts for 73 per cent of total G&A cost, with the Townsville office (mainly HR, IT, Corporate, Finance and HSEC functions) accounting for the balance.

Table 2.6: Cannington Operations – Operating Cost estimate (real)

Item (USD/wmt ROM)	FY15 2 nd H	FY16	FY17	FY18	FY19	FY20 – 23 average
Mining	46.59	47.81	50.55	51.99	58.52	60.08
Processing	18.69	20.00	20.78	22.08	21.91	23.98
Transport	9.48	11.20	11.94	12.19	11.33	9.84
General and Administration	31.77	33.22	33.39	35.66	41.89	31.36
Shipping	3.94	4.04	4.41	4.46	3.95	3.31
Closure	-	0.03	0.01	0.01	0.01	8.47
Other (Marketing and Exploration)	2.85	2.72	1.62	1.23	1.23	0.97
Total	113.32	119.02	122.68	127.61	138.83	138.02

Source: BHPB Minerals, Xstract estimate

2.9 Market analysis

The quality of the Cannington lead concentrate is excellent with significant by-product credits for silver making it highly attractive to the market. The zinc concentrate is of moderate quality and also contains appreciable silver contents. Fluorine and MgO levels are actively monitored and managed with blending required to ensure levels remain within acceptable limits.

The concentrates are sold under a number of long-term contracts to both domestic and international customers.

Lead products are dominated by the use in batteries at around 80 per cent of lead consumption. Other principal uses of lead include sheathing and protection (from rolled products), and pigments in compounds.

The market for lead products is growing at a slow pace and it is expected that global lead will increase at a gentle pace over the next few years. However, recycling is likely to account for most of the increase in lead metal production, as both recycling technology and availability increases.

The lead price typically has less volatility than most other traded commodities, being range bound between USD2,000 to 2,300/t (refined metal) for the last 18 months. Similar to both silver and zinc, lead is commonly mined in poly-metallic operations, such as the Cannington Operations. Importantly, newer zinc mines, which are set to bring production online contain lower lead concentrations than has historically been the case. Constrained supply is likely to underpin the current lead price. However, demand for lead is unlikely to reach the highs of 2011 anytime soon, with the highest lead price in recent history only around USD3,500 per tonne.

The zinc price correlation to general industrial demand favours a forward zinc price, which is higher than the present. A number of strong opportunities exist within the zinc market over the next decade. For example, in China around 5 per cent of flat steel products have some form of galvanization, whereas this figure is above 15 per cent in the USA and Europe. China is expected to have reasonably strong, but not growing, demand over the next period.

On the supply side, a number of zinc mines are either contracting or closing. The net contraction, predicted to occur during 2017 to 2018, is around 11 per cent of primary zinc production. This contraction effect is not expected to flow on higher prices in the immediate future, however will underpin the zinc market in the longer term.

Silver's exposure to both industrial and precious applications means that the demand base for silver metal is relatively stable, even if the commodity price remains as volatile as other precious metals, such as gold, or other industrials, such as copper. Silver is used in technological applications, which leads to silver demand forecasts remaining strong in the future. Silver is used in cars (including electric cars and other electric vehicles), computers, phones and tablet devices, televisions and photovoltaic solar power equipment.

The supply of silver into the market comes from mines, scrap (recycling) and government sales. The silver market is around 75 per cent supplied by mines, which are a combination of silver mines and polymetallic operations. Most mined silver is a co-product or a by-product, as is the case with Cannington Operations. The silver price is therefore somewhat exposed to the general commodity and industrial market.

2.10 Regional exploration

In addition to the Cannington MLs, BHPB Minerals also holds 13 granted EPMs, which stretch discontinuously for some 100 km to the north and 150 km to the south of Cannington Operations (Figure 5.1). These tenements all lie along a north-south trend, which coincides with the interpreted extents of the Proterozoic Soldiers Cap and Fullarton River Groups. The principal exploration target is BHT lead-zinc-silver mineralisation similar to that at the nearby Cannington Operations, Pegmont, Altia and Maronan deposits.

In the past, BHPB Minerals has completed a number of regional and detailed aeromagnetic, ground magnetic, electromagnetic, regional gravity and GEOTEM surveys across the region, building up an extremely valuable geophysical database.

With the exception of EPM6788 and EPM11675, all tenements have been granted within the past three years and hence remain in the early stages of assessment.

Given declining lead and silver grades at Cannington Operations, and deferral in the open pit plan, Cannington Asset's exploration efforts are heavily focussed on the discovery of additional near-mine, silver-rich deposits associated with the Soldier Cap Group. Based on a five year discovery and development window, Cannington Asset's objectives are to discover:

- a deposit exceeding 15 Mt with grades above 250 g/t silver within 25 km of Cannington Operations in the short term (1 to 3 years), and

- a deposit exceeding 25 Mt at grades of above 300 g/t silver within 100 km of Cannington Operations over the longer term (3 to 5 years).

The regional exploration assets are not considered to be material in terms of the overall value assigned to the Cannington Asset, however they are important as they provide further growth options going forward.

Cannington Asset's recent exploration expenditures and budget forecasts are summarised in Table 2.8.

Table 2.7: Actual and Forecast Exploration Expenditure (AUD M) – FYs 2012 to 2017

	FY12	FY13	FY14	FY15	FY16	FY17	TOTAL
Near Mine	9	5.5	6.1	5.8	6.2	-	32.6
Regional	3.8	1	1.8	1	-	-	7.6
Underground	0.3	1.3	-	0.7	-	-	2.3
TOTAL	13.1	7.8	7.9	7.5	6.2	-	42.5

Source: BHPB Minerals

2.11 Risks and opportunities

2.11.1 Geology

The risk of grade estimation inaccuracy from a simplistic approach is mitigated by the level of detailed geological knowledge and high density of sample data. An opportunity to improve the quality of local grade variability estimation, which leads to improved mining selectivity, arises from this risk.

A conservative Mineral Resource classification creates a risk of understating the Mineral Resource that could potentially lead to impeding the rate of development of new mining areas. The integration of geological and grade continuity with Mineral Resource classification creates the opportunity to increase the scale and proportion of higher confidence Mineral Resources whilst also optimising drill spacing to reduce future capital expenditure.

The inclusion of an additional 700 drill holes, drilled between 2012 and 2014, into future Mineral Resource estimates hold significant potential to increase the Cannington Mineral Resource estimate scale and confidence.

The reduction and then termination of regional exploration funding after FY16 appears to be consistent with near mine exploration being the more significant opportunity to increase Mineral Resources on the scale of the Cannington deposit. Structural repetition of Cannington mineralisation both along strike from faulting and across strike from folding creates this potential, with the positive exploration results south of the Cannington deposit indicating that this is the most prospective area.

2.11.2 Mining

The Cannington Operations is a long-established operation, which has worked through the majority of risks normally associated with mining. Key perceived mining risks include:

- The mining extraction factors possibly overstate the Ore Reserve grade.
- Cannington Operations has undergone a number of expansion projects since commissioning at 1.5 Mtpa in 1997. Sustaining production rates will become increasingly difficult as the Ore Reserve is depleted.

- Decommissioning and replacement of the current ore handling system has the potential for significant production disruptions.
- Deteriorating ground conditions should be expected as the mine ages and stresses are redistributed around mining zones.
- Potential localised ground failures and rehabilitation requirements are likely to become an increasing factor on the ability to maintain access and mine services to maintain production levels.

Hand-in-hand with the risks that have been identified are some potential opportunities able to add value to the mine should they be investigated and implemented. Opportunities include:

- The North Upper and North Outer blocks are currently under evaluation. It is expected that these blocks will become part of the Ore Reserve upon completion.
- Designed stopes have been excised from the current Ore Reserve because they are scheduled beyond 2023 when sustainable mine production rates cannot be achieved (to cover fixed costs). Potential exists to lower the cut-off grade and re-scheduling to minimise any residual production tail thereby including material that could not otherwise be mined economically.
- Any Inferred Resource material within designed stope wireframes (approximately 10 per cent) is not included in the Ore Reserve. Xstract expects this material would be upgraded to Ore Reserve status during the final stope design process.
- Alternate mining methods/equipment may provide opportunity to mine a proportion of some exceptionally high-grade remnants (>AUD500/t).
- At current price forecasts, no open pit is included in the mine plan, however, the potential exists if there is a material increase in metal prices (particularly for silver).

2.11.3 Processing

The Cannington Operations processing plant is a mature operating plant. The main equipment related risk is a mechanical failure of the autogenous grinding ("AG") mill. This event would be quite significant in that, as a life-line item, production would be interrupted for a number of months. However, the likelihood of such an event occurring is extremely low and, given the good maintenance programme on-site it is most probable that any there would be an early warning of possible failure.

Metallurgical performance risk is low but because of reducing head grades it is likely recoveries and concentrate qualities will be less than what is forecast. There is a minor risk that weather could close road access for a short period thereby preventing supplies to be brought into site as well as concentrates to be taken out. However, this risk is well considered in that Cannington Operations has been operating continuously since 1997 and protocols will have been set up to allow sufficient reagents and consumable to be held on-site to allow the plant operations to continue until the roads are usable.

As the plant has been operating successfully over an extended period, there are few opportunities available for major improvements. Cannington Asset has an ongoing programme in place to assess opportunities for improvements across the Cannington Operation. One possibility may exist with sales of lead concentrates to Xstrata's Mount Isa lead smelter. The high Ag values may preclude such an opportunity and there are continuing rumours regarding the closure of this smelter.

Xstract considers the processing operations at Cannington Operations to be of high quality and providing the existing operating and maintenance practices are maintained, the plant should perform well for the over the currently defined LOM period.

2.12 Valuation

Income approach

Cannington Asset compiled a financial model, which Xstract has modified to incorporate changes to Cannington's LOA production schedule as required to support a valuation of the Ore Reserves only. The results of the Cash Flow Approach are summarised in Table 2.8. The tables present the Net Present Values ("NPV") of the post-tax pre-finance cash flows as determined from the financial model and include the variation in NPV with a range of real discount rates from 8 to 12 per cent.

Table 2.8: Summary Valuation of Cannington Ore Reserves

Discount Rate	USD M	USD /toz Ag metal ratio
8% (real)	1,051.4	
9% (real)	1,020.9	2.90
10% (real)	991.7	2.82
11% (real)	963.6	2.74
12% (real)	936.8	

Source: Xstract estimates

The value assessed in Xstract's DCF analysis considers only the currently defined Ore Reserves at Cannington Operations. Xstract is also cognisant of the following:

- In addition to the scheduled 19.9 Mt of Ore Reserves, there is an additional 6.9 Mt of Inferred Resources in the current mine plan. Given the requirement to value only Ore Reserves as part of this Competent Persons Report, these additional Inferred Resources were not valued.
- Optionality associated with the defined Mineral Resources outside of the current LOA mine plan.
- Given the high quality, low cost tonnes currently defined at Cannington Operations, Xstract considers these Mineral Resources would be highly attractive in the current market, despite the current malaise and outlook towards commodity pricing.
- The strategic location of Cannington Operations relative to other world-class mining assets (i.e. Mount Isa, Ernest Henry, etc) in the Mount Isa Inlier along with its proximity to established transport infrastructure is likely to hold considerable appeal.
- Analysts suggest the recent market has been applying a discount to project NPV as measured by Price/Net Asset Value or NPV/share ratios. This suggests that analysts believe the market is not recognising and paying for project upside.

Market approach

In order to validate the values derived by DCF analysis, Xstract has considered recent transactions involving similar quality assets to those at Cannington. In doing so, Xstract has reviewed data provided by SNL and IntierraRMG. SNL and IntierraRMG provide databases of comparable transaction of silver-lead-zinc projects and mines. Xstract selected eleven transaction considered comparable that transpired between January 2010 to November 2014.

Analysis of the data for projects hosting Proved and Probable Ore Reserves resulted in a range of normalised transaction values from USD0.09/toz to USD4.82/ toz Ag metal ratio, with an average of USD0.97/ toz Ag metal ratio.

For Cannington Operations, the implied value of Xstract's DCF analysis equates to between USD2.74/toz and USD2.90/toz Ag metal ratio. This lies within, but at the upper end of, the range implied by recent market transactions, which Xstract considers to be reasonable.

Valuation summary

While the comparative transaction data supports the results derived from the DCF methodology, it is Xstract's opinion that the DCF modelling results provide a more conclusive indication of the current market value of Cannington Operations' Ore Reserves.

Based on the calculations described above, Xstract has assigned values for a 100 per cent interest in the Cannington Ore Reserves, as summarised in Table 2.9.

Table 2.9: Assigned Value to the Cannington Ore Reserves in 100 per cent terms

Project	Low (USD M)	High (USD M)	Preferred (USD M)
Cannington Ore Reserves (100%)	964	1,021	992

Source: Xstract estimates

This valuation is reflective of the Cannington Asset, based on our view in relation to Ore Reserves only. It is important to emphasise that this value does not represent the value of the Ore Reserves in the ground in isolation, but rather, incorporates the value of all of ungeared net assets contributing to the Asset based on an Ore Reserves production profile. For example, at Cannington this includes the value of the use of processing facilities/truck fleet/rail loading facilities/rail entitlement/port infrastructure, as well as the mine.

3 Introduction

3.1 Background

Xstract has been commissioned by South32 to prepare an independent Competent Persons Report on the Cannington Asset, located in the Mount Isa Inlier of northwest Queensland, Australia.

The Cannington Asset is to be demerged from BHP Billiton, along with certain other aluminium, coal, manganese and nickel assets, into a new corporate entity, South32. Simultaneously, South32 will seek a listing on the ASX, the JSE, and on the Official List of the UKLA, in order to trade on the Main Board of the LSE, collectively referred to as the "Relevant Listing Authorities".

Xstract understands that this Competent Persons Report is to be included in its entirety in an ASX Information Memorandum, a JSE pre-listing statement and a UK prospectus, collectively referred to as the "Listing Documentation".

3.2 Review process

In preparing this Competent Persons Report, Xstract carried out the following scope of work:

- Introductory meeting with BHP Billiton's management and technical teams to understand the assets and associated production/development strategy and business plan.
- Inspection visits to the Cannington Asset mining and processing facilities, surface structures and associated infrastructure.

- Discussion and enquiry, following access, to key project and corporate personnel between October and December 2014.
- An examination of historical information and results made available by BHP Billiton in respect of the technical aspects of the Cannington Asset. Key elements reviewed included:
 - Geology reports and models, including geotechnical and hydrological aspects
 - Mineral Resource and Ore Reserve estimates
 - Mining operations and proposed growth options
 - Processing plant
 - Materials handling and transport
 - Port operations
 - Environmental approvals and matters
 - Veracity of existing information supporting life of mine and business plans
 - Identification of key project drivers
 - Risks and opportunities
 - Valuation of Ore Reserves
- A review and where considered appropriate by Xstract, modification of Cannington Asset's production forecasts contained in the LOM plans.
- Preparation of a Competent Persons Report capable of supporting a listing on the ASX, JSE and LSE.

The technical information as provided to, and taken in good faith by Xstract, has **not been independently verified** by Xstract by either a full audit or by means of complete re-production of the Mineral Resource and Ore Reserve estimates. Instead, Xstract's review focussed on the following:

- Cannington Asset's Competent Person's report was reviewed for compliance with the JORC Code and the reported totals cross referenced to the reported tonnages supporting the supplied financial model.
- An independent financial model was compiled and validated with the model supplied by Cannington Asset.
- Where fundamental base data was provided (LOM, capital expenditures, operating budgets, etc.), Xstract performed necessary verification procedures deemed appropriate in order to place an appropriate level of reliance on such information, in particular:
 - Specific audits and checks of the resource model, informing data and estimation process to confirm it is appropriate for the deposit, and that the classification and reporting complies with the JORC Code.
 - Assessment and benchmarking of production assumptions, mining rate and production schedules were verified against Cannington Asset historical production data supplied through management reporting and then matched against the physicals in Cannington Asset's financial model.
 - Capital and operating costs were assessed against other comparable projects for reasonableness.
- Material technical issues likely to impact on the LOM plan and the future performance of Cannington's assets were identified and evaluated.

Based on its review, Xstract has developed an in-house understanding of the Cannington Asset. Xstract considers the technical information supplied to be appropriate for independent peer review and public reporting purposes.

This report includes information on Mineral Resources (inclusive of Ore Reserves) as reported by: B Coutts (MAusIMM) and Ore Reserves as reported by: M Dowdell (MAusIMM).

The information is extracted from the report titled BHP Billiton 2014 Annual Report and is available to view on www.bhpbilliton.com.

All Competent Persons are full-time employees of BHP Billiton at the time of reporting and have the required qualifications and experience to qualify as Competent Persons for Mineral Resources under the 2012 Edition of the "Australasian Code for Reporting of Exploration Results, Mineral Resources and Ore Reserves" ("JORC Code"). The Competent Persons verify that the report is based on and fairly reflects the Mineral Resources and Ore Reserves information in the supporting documentation and agree with the form and context of the information presented.

BHP Billiton confirms that it is not aware of any new information or data that materially affects the information included in the original market announcements and, in the case of estimates of Mineral Resources and Ore Reserves, that all material assumptions and technical parameters underpinning the estimates in the relevant market announcements continue to apply and have not materially changed. BHP Billiton confirms that the form and context in which the Competent Persons' findings are presented have not been materially modified from the original market announcements.

3.2.1 Site visits

Xstract representatives visited the Cannington Asset as summarised in Table 3.1.

Table 3.1: Summary of Xstract's site visits

Asset	Dates	Days	Xstract Representatives
Cannington Mine	28 Oct 14	1	M Readford, T Horsley, D Elder, C Miller
Townsville Office	27 & 29 Oct 14	1.5	M Readford, T Horsley, D Elder, S Barry
Townsville Port Facilities	29 Oct 14	0.5	D Elder

During this visit, site infrastructure, workings and operations were inspected. The site visit substantiated the location and scale of the Cannington Asset, which are supported by the development and production results detailed elsewhere in this report.

3.3 Structure

This Competent Persons Report has been structured on a technical discipline basis into sections on Geology, Mineral Resources, Ore Reserves, Mining, Processing, Equipment, Manning, Health and Safety, Infrastructure, Transportation, Marketing, Environmental, Social, and a Valuation of the Cannington Ore Reserves.

The report is structured by development status. The operating assets are discussed first followed by brownfields and regional greenfields exploration projects. All material projects for which JORC Code compliant Mineral Resources and Ore Reserves are reported, have been discussed in detail. Only brief summaries are provided of the regional exploration projects as these generally remain in the early stages of assessment and are not considered by Xstract to be material to the Cannington Asset.

3.4 Compliance

This Competent Persons Report has been prepared in accordance with the listing requirements of the Relevant Listing Authorities, namely:

- The ASX Listing Rules, in particular Chapter 5 and Guidance Note 31.

- The JSE Listing Requirements, in particular Section 12.
- The “Prospectus Rules” published by the Financial Conduct Authority (“FCA”) and governed by the UKLA.
- The “Prospectus Directive” (2003/71/EC) and “Prospectus Regulations” (809/2004)
- Sections 131 to 133 and Appendices I to II of the ESMA Recommendations for the consistent implementation of EC No 809/2004, implementing the Prospectus Directive” (the “ESMA Recommendations”, as revised in March 2013).

This report has also been prepared in compliance with internationally accepted mineral reporting codes, these being:

- The 2012 Edition of the JORC Code
- The 2005 Edition of the VALMIN Code.

Xstract specifically notes that Cannington’s Mineral Resources are reported as inclusive of Ore Reserves.

In line with the requirements of the VALMIN Code, value is defined as ‘fair market value’ (“FMV”), being the amount for which a mineral asset should change hands between a willing buyer and a willing seller in an arm’s length transaction where each party is assumed to have acted knowledgeably, prudently and without compulsion.

3.5 Data sources

In developing our assumptions for this report, Xstract has relied upon information provided by BHP Billiton, Cannington Asset and information available in the public domain including:

- Various papers extracted from technical conference proceedings and Australasian Institute of Mining and Metallurgy (“AusIMM”) Monographs.
- Press releases, public announcements, media and analyst presentation material and other public filings, including information available on BHP Billiton’s website.
- Brokers’ reports and recent press articles on BHP Billiton and other comparable companies, as well as the base metal and precious metal industries.
- Share market data and related information on Australian and international listed companies engaged in the base metal and precious metal industries and on acquisitions of companies and businesses in these industries.
- Information relating to the base metal and precious metal markets including forecasts regarding supply and demand, commodity price, inflation rates and exchange rates.

Key sources are outlined in this report and all data included in the preparation of this report has been detailed in the references section of this report. In the execution of its mandate, Xstract reviewed all relevant pertinent technical and corporate information made available by representatives of BHP Billiton, which has been accepted in good faith as being true, accurate and complete, after having made due enquiry.

3.6 Competent Persons and Experts statement

Xstract’s consultants involved in the preparation of this report are Competent Persons and Independent Experts and have the requisite experience as defined in Section 11 of the JORC and Section 37 of the VALMIN Codes, respectively. They are also members of either the AusIMM, the Australian Institute of Geoscientists (“AIG”) or other Recognised Professional Organisations (“RPO”), for which compliance with the JORC and VALMIN Codes is mandatory. Xstract’s Competent Persons involved in the preparation of this report are members in good standing with one or more of these professional institutions and have the required qualifications and experience as defined in the JORC and VALMIN Codes to conduct this technical assessment and valuation.

Xstract's consultants have extensive experience in preparing competent persons, mineral specialist, independent geologist and valuation reports for mineral exploration and production companies. The authors of this report are qualified to express their professional opinions on the values of the mineral assets described.

3.7 Reliance statements

This report is dependent upon technical, financial and legal information supplied by South32 and BHP Billiton. A listing of information relied upon by Xstract is included in Section 11.

Xstract understands from discussions with BHP Billiton that in parallel, but independent to this technical review, BHP Billiton has commissioned separate reviews of the corporate and legal aspects of Cannington Asset. These reviews and their subject matter are not included in this Competent Persons Report as they were not available to Xstract at the time of writing.

3.7.1 Technical reliance

Xstract places reliance on the BHP Billiton and its technical representatives that all technical information provided to Xstract as at 11 March 2015, is a fair and accurate account of the current status of the Cannington Asset under review.

The Competent Person with overall responsibility for reporting of Mineral Resources at the Cannington Asset is Mr Ben Coutts, who was the Manager Resource Planning at the time. Mr Coutts is a geologist with 24 years' experience in mine geology, resource planning and mine operations. He is a Chartered Professional Member of the AusIMM and Fellow of the Society of Economic Geologists. Mr Coutts is qualified as a Competent Person as defined in the JORC Code.

The Competent Person with overall responsibility for reporting of Ore Reserves and technical studies at Cannington Asset is Mr Mark Dowdell, who is a full time employee of the Company, in the capacity of Senior Mine Planning Engineer. Mr Dowdell is a mining engineer with 13 years' experience, including 10 years at Cannington Operations in mine planning. He is a Member of the AusIMM and is qualified as a Competent Person as defined in the JORC Code.

Xstract's Competent Persons' responsible for the presentation of information and opinions expressed in this Competent Persons Report are:

- Jeames McKibben, MBA, BSc(Hons), MAusIMM(CP), MAIG, who is responsible for the valuation of Cannington's Ore Reserves and the overall preparation of this Competent Persons Report. Jeames is General Manager – Corporate Advisory with Xstract and has over 20 years' international experience in the mining industry. He is a current member of the VALMIN Code Review Committee and a Representative Expert as defined in the VALMIN Code.
- Matthew Readford, MBA, Bsc(Hons), MAusIMM(CP Geo) who has overall responsibility for the Mineral Resources and geological aspects of this report. Matthew is a Manager – Geology with Xstract and has over 20 years' experience as a geologist and six years as a Management Consultant. He is a Competent Person as defined in the JORC Code.
- Tim Horsley, BSc(Hons), MAusIMM, who has overall responsibility for the Ore Reserves and mine engineering aspects of this report. Tim is an Associate Consultant with over 36 years' experience as a mining engineer in both operational and consulting roles. He is a Competent Person as defined in the JORC Code.
- Roland Nice, BSc(Met Eng) and FAusIMM, MSME, LMCIMM, MIEA Chartered Eng (Chem), who is responsible for the metallurgical processing aspects of this report.

Roland is an Associate Consultant has over 45 years international experience as a Metallurgical Engineer in both operations and consulting roles. He is a Competent Person as defined in the JORC Code.

- Craig Miller, BSc, MSc, PhD, is a member of the International Society of Sustainability Professionals, who has overall responsibility for the environmental and social aspects of this report. Craig is an Associate Consultant – Environment for Xstract with over 20 years' experience in ecological research and natural resource management.

3.7.2 Financial reliance

In consideration of the financial aspects relating to the Cannington Asset, Xstract has placed reliance on BHP Billiton that the following information as they may relate to the Cannington Asset, specifically the financial/accounting inputs to the Financial Model are appropriate as at 11 March 2015:

- Taxation aspects for all taxes including: opening balances; determination of tax-deductible items (depreciation); and summary of applicable taxes;
- Opening balances for debtors, creditors and stores and any associated working capital calculations as appropriate; and
- Other relevant financial aspects as would be required by potential investors in order to determine a technical valuation of Cannington Asset's currently defined Ore Reserves.

The financial information referred to above has been prepared by BHP Billiton.

3.7.3 Legal reliance

South32 has advised Xstract that it has commissioned other corporate and legal reviews pertaining to Cannington Asset. Xstract understands that a detailed statement of all legal proceedings, which may have an influence on the rights to explore for or mine base and precious metals or an appropriate negative statement has been included in the body of the Listing Documents.

In regard to legal matters pertaining to the Cannington Asset, Xstract refers readers to the Listing Documents, in particular statements under Risk Factors and Preparation of this Document sections.

This Competent Persons Report specifically excludes all aspects of legal issues, land titles and commercial agreements, except such aspects as may directly influence technical, operational or cost issues. Xstract is not qualified to express legal opinion and has not sought any independent legal opinion on the ownership rights and obligations relating to the assets under licence or any other fiscal or legal agreements that BHP Billiton may have with any third party in relation to the Cannington Asset. Dispensation has been granted in this regard from inclusion in this report.

3.8 Independence, disclaimer and warranty

Xstract is an independent mining consultancy. Xstract was commissioned by South32 on a fee for service basis according to Xstract's standard schedule of rates. Xstract's fee is not contingent on the success of the demerger or any related transactions. Other than disclosed here in Table 3.2, none of Xstract's consultants or their immediate families involved in the preparation of this valuation report have (or had) a pecuniary or beneficial interest in BHP Billiton prior to or during the preparation of this report.

Xstract's Competent Person for Geology, Matthew Readford, has recent involvement with the Cannington Asset's mine planning process. This involvement is not considered to conflict the independence of this Competent Persons Report. In August 2014, Mr Readford

prepared a grade and tonnage model for the mine's routine internal mine planning scenario purposes. This work was completed after the Cannington Asset's FY14 Mineral Resource estimate, which is the subject of this Competent Person's Report, had been reported and prior to commencement of this Competent Persons Report in November 2014. Neither the grade and tonnage model or the internal planning scenarios have been considered during the compilation of this Competent Persons Report. As such, Mr Readford was not required to review and/or comment on his own work as part of the preparation of this Competent Persons Report.

Table 3.2: Consultant shareholdings in BHP Billiton as at 11 March 2015

Consultant	BHP Billiton shares held	Comments
J McKibben	0	
M Readford	0	
T Horsley	0	
D Elder	0	
R Nice	983	Held in self-managed superfund
C Millar	0	
R Price	0	
S Barry	0	
M Longworth	0	13,397 shares held by father in a trust. Shares purchased in 1982, 1987 and 1992.

A draft version of this report was provided to representatives of BHP Billiton for comment in respect of omissions and factual accuracy. BHP Billiton has represented in writing to Xtract that full disclosure has been made of all material information and that to the best of its knowledge and understanding, such information is complete, accurate and true.

This report may contain or refer to forward-looking information based on current expectations. Forward-looking statements include, but not limited to, the timing of future production, anticipated production rates, grades, projected metallurgical recovery, Ore Reserve/Mineral Resource estimates, infrastructure, capital, operating and sustaining capital, the projected life of mine, mine design and potential impact on cash flow, future commodity pricing, government regulations, maintenance or renewal of permits or tenure, estimation of closure costs, environmental mitigation measures, future exploration or project development programmes and general business or economic conditions. Forward-looking information is subject to significant risks and uncertainties, as actual results may differ materially from forecasted results. Forward-looking information is provided as of the date hereof and Xtract assumes no responsibility to update or revise them to reflect new events or circumstances.

The conclusions expressed in this Competent Persons Report are appropriate as at 11 March 2015. The report is only appropriate for this date and may change in time in response to variations in economic, market, legal or political factors, in addition to ongoing exploration and development studies. All monetary values outlined in this report are expressed in USD or AUD, unless otherwise stated.

4 Cannington Asset

4.1 Introduction

BHP Billiton, through its wholly owned subsidiary, BHPB Minerals, wholly owns and operates the Cannington Asset silver-lead-zinc mine and associated infrastructure in northwest Queensland, Australia.

The key assets comprise the following:

- A 100 per cent interest in the Cannington Operations and associated infrastructure including borefield, rail siding and Townsville port allocation, and
- Various exploration properties located in northwest Queensland to the north and south of Cannington Mine.

The Cannington Asset is an integrated underground mining and metallurgical processing facility with a nominal processing capacity of over 3.2 Mtpa. Now in its second decade of production, Cannington Asset is currently one of the world's largest and lowest cost producers of silver, lead and zinc concentrates. Major aspects of the operation include underground mining, ore processing, tailings management, waste rock, stormwater drainage and storage, transport, water supply, power and waste management.

The Cannington Asset has been operational since 1997, with mining currently carried out using sub-level open stope and modified bench mining methods. Approximately two-thirds of the ore is crushed underground and hoisted to the surface, whilst the other one-third is hauled directly to the surface for crushing. Processing involves grinding through a mill and selective flotation and leaching to liberate a zinc concentrate and a silver-rich lead concentrate. Up to 500,000 tonnes ("t") of high-grade marketable concentrates are produced annually.

In addition to the underground mining and associated metallurgical processing facilities, the Cannington Operations rely on other BHP Billiton-owned and operated infrastructure including a rail-loading facility located at Yurbi, 15 km southeast of Cloncurry, and a ship-loading facility in Townsville, some 750 km to the east. Concentrate is trucked direct to customers (principally Mount Isa) or to Cannington Asset's Yurbi railhead, where it is loaded onto covered train wagons for transport to the Townsville port facility or customer facilities. Once at the port, concentrate is unloaded, stored, and loaded onto ships at a purpose-built wharf and ship-loader.

4.1.1 Company structure

The holding structure of the Cannington Asset within the BHP Billiton Group of companies is summarised in Figure 4.1 below, while the Administrative structure of Cannington Asset is presented in Figure 4.2.

Figure 4.1: Holding structure

Current holding structure of Cannington Operations within the BHP Billiton Group of companies:



Post transfer holding structure of Cannington Operations within the BHP Billiton Group of companies:



Source: BHPB Minerals

Figure 4.2: Administrative structure of Cannington Asset

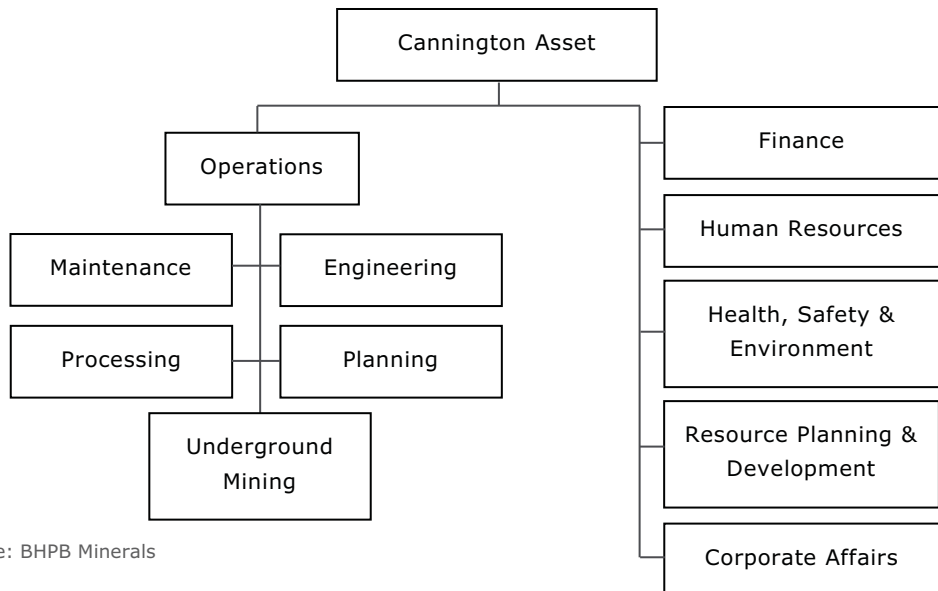

Source: BHPB Minerals

4.1.2 Strategy

The Cannington Operations have a current Ore Reserve life of approximately nine years. However, in recent years, Cannington Asset has been evaluating various options to extend the mine life as economically available underground Ore Reserves diminish.

While no detailed studies have yet been completed, the currently favoured option is the transition of the mine from underground to an open cut operation, which, if it proceeds, will extend the life-of-mine by up to twenty years, and could increase mine production to 6 Mtpa. Four factors currently hinder the commencement of open pit mining operations:

- The position of the ore being considered for mining from the open pit relative to the current shaft and pastefill infrastructure, hence open pit mining only becomes possible once all underground mining operations are complete.



- As the process facility on-site is already exceeding its name plate capacity, the capacity of the process plant capacity would need to almost double in order to accommodate any open pit ores.
- Conceptual level studies indicate that a consistent silver price in excess of USD27/oz would be required to achieve an IRR of 15 per cent or more.
- The estimated establishment cost of this mine life extension project is below AUD600 M.

On this basis, any decision regarding the development of the Cannington open pit has been deferred.

4.2 Location, access and local Resources

4.2.1 Location

The Cannington silver-lead-zinc mining and processing operations are located at latitude 21°52'9" South and longitude 140°55'10" East on the Duchess (SF 54-6) 1:250,000 scale and the Selwyn (7054) and El Rita (7154) 1:100,000 scale map sheets.

The complex lies approximately 135 km south-southeast of Cloncurry, 200 km southeast of Mount Isa and 700 km west of Townsville in northwest Queensland, Australia (Figure 4.3). The closest township is McKinlay, approximately 85 km to the north. Mount Isa and Cloncurry are the nearest significant population centres (around 35,000 and 2,400 people respectively) to the Cannington Operations. Mount Isa provides a reasonable standard of education, medical, recreation, retail and professional services (including legal, financial and major banking institutions).

Figure 4.3: Location of the Cannington Operations

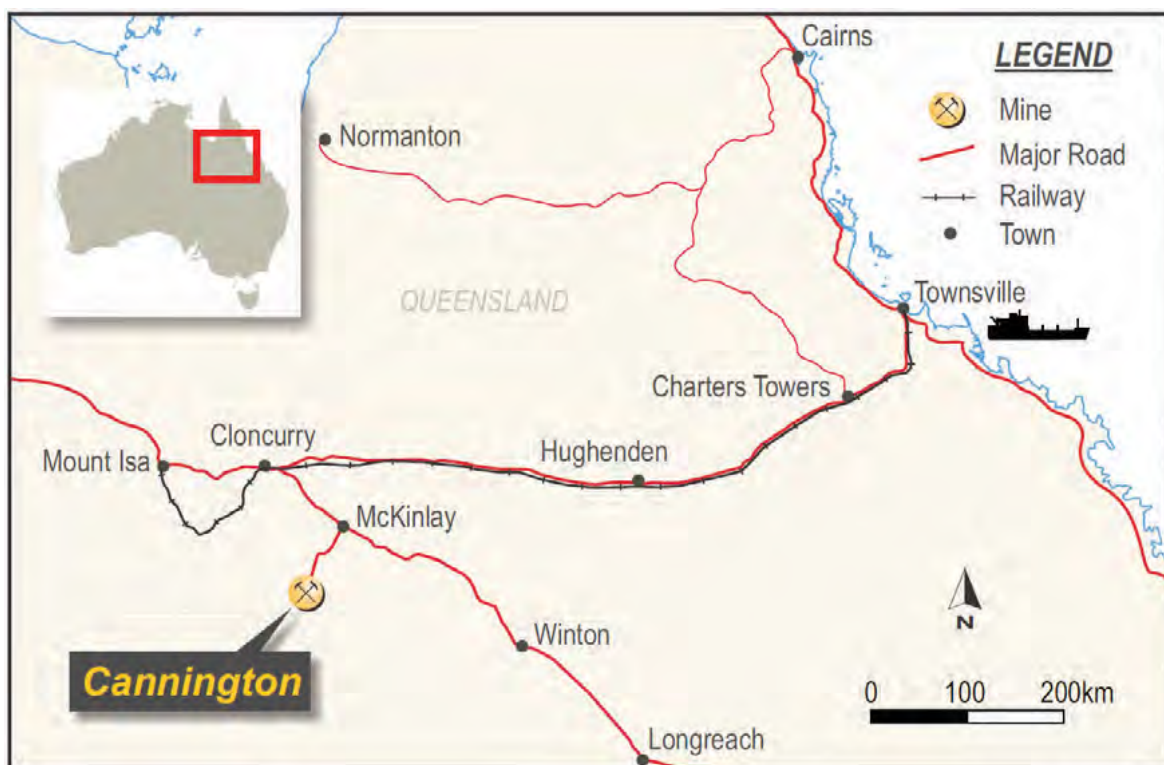

Source: BHP Billiton, Xstract

4.2.2 Access

Access to Cannington Operations from Cloncurry is along the national Landsborough (or Matilda) Highway, which connects Cloncurry with Charleville, to McKinlay and then south along the sealed Toolebuc-McKinlay Road for approximately 80 km. Total travel time from Cloncurry is approximately two hours. The regional location of the Project site is shown in Figure 4.3.

As Cannington Operations work on a fly-in-fly-out (“FIFO”) basis, the complex supports its own private airport (Trepell Airport), situated approximately 2 km west of the accommodation village. Air charter flights between site and Townsville (population 185,000) occur most week-days, with arriving workers transported by bus from the airport to the accommodation village. Limited employee transportation by light vehicle originates from Mount Isa and/or Cloncurry.

The majority of concentrate produced at Cannington Operations is hauled by covered quad-trailer road-trains to the Yurbi railhead loading facility, where it is transported to the Port of Townsville via rail. The Yurbi Rail Siding is located about 15 km east of Cloncurry and is associated with the Mount Isa System – a rail line network, which extends from Townsville through to Mount Isa.

Some concentrate is road hauled direct to Mount Isa, and if rail transport were to be unavailable for an extended period (i.e. industrial dispute), concentrate may be road hauled to Townsville.

4.2.3 Local Resources

The mine site is well-supported by vehicle workshops, bulk fuel and reagent storage, a warehouse, administration buildings, water treatment plants, a remote borefield, process plant, power station, a small explosive emulsion facility and magazine, and an accommodation village.

The existing accommodation village is located approximately 4 km north of the mine area and comprises accommodation units, sporting and recreational services, kitchen, laundries and mess.

Power is currently generated on site using mainly natural gas and diesel, with a generating capacity of 37 megawatts (“MW”). The power station is owned and operated by a third party. The facility comprises 30 Caterpillar natural gas engines, four Caterpillar diesel engines for stand-by emergency power, and a thermal steam raising plant. Cannington Operations receive natural gas from the Carpentaria Gas underground pipeline, which approaches the mine site from the southwest. The pipeline has sufficient capacity to supply the generating capacity required by the mine.

The main water supply for Cannington Operations is from a BHP Billiton-owned and operated borefield located approximately 20 km to the east of the mine. This borefield has operated since September 1997 and comprises nine commissioned bores to access groundwater from of the Great Artesian Basin. The Cannington borefield licence allows a nominal maximum groundwater extraction in any one water year of 2,210 mega litres (“ML” – equivalent to an average rate of 70 litres/second) until June 2022. Groundwater levels and water quality monitoring is required under the groundwater licence. Potable water is produced on-site.

The communications tower is also third party infrastructure on a special lease. Other services to the mine site include power lines, pipelines, phone and optic fibre.

Supplies are transported by road haulage from Mount Isa and services sourced from either Mount Isa or Townsville.

At Yurbi, concentrates are stored in a 12,500 tonne enclosed storage shed, until ready to be loaded onto specially designed rail wagons. Other infrastructure includes a rail loop, service road, office, workshop, crib room, wash bays, fuel storage and refuelling station, and diesel-powered generator. Ore concentrate hauled from Yurbi via rail is delivered to a zinc refinery near Townsville, or BHP Billiton's dedicated concentrate storage and ship-loading facilities at the Port of Townsville.

Port infrastructure in Townsville includes a rail wagon tippler, conveyor system and transfer points, concentrate storage facility, outer wharf conveyor, sumps and ponds, stormwater tanks and treatment plant, workshop, wash bay and offices and bath house.

The zinc smelter is located at Stuart, 15 km south of Townsville. The smelter commenced production in late 1999 and processes some 450,000 tpa of zinc concentrates, mainly sourced from northwest Queensland, to produce approximately 200,000 t of zinc metal annually. Concentrates are blended on site to provide a consistent chemical composition for the smelting process. Approximately 360,000 t of sulphuric acid is produced as a by-product and is used elsewhere in Queensland to produce high-quality agricultural fertilisers and other industrial uses. Other by-products such as zinc ferrite and copper are also produced and sold to the international and domestic market.

Further details of the infrastructure supporting operations are outlined in Section 4.13.

4.3 Climate, physiography and land use

4.3.1 Climate

The climate is typical of the inland arid zones of sub-tropical northwest Queensland and is amenable to year round exploration and mining activities. November to January are the hottest months (from 25° to 40°C) and June to August the coolest (from 10° to 25°C). The wet season extends from November to March, when scattered thunderstorms (and occasional tropical cyclones) and associated monsoonal depressions cross the area. Rainfall during this period is typically of short duration but of high intensity and may result in road closures due to flooding for periods generally less than one week in duration. Average annual rainfall at Cannington Trepell Airport is 345 mm. Evaporation is extremely high at approximately 2,300 mm per annum.

Light to moderate winds from the south and southeast are predominant in the region.

4.3.2 Physiography

The physiography of the area comprises gently undulating plains with many low ridges and alluvial flood plains incised by numerous ephemeral watercourses and creeks with a surface elevations varying from about 200 to 400 m above sea level. The Selwyn Range lies 10 km to the west of the Project boundary and steep rugged hills occur to the west. Eucalypt-spinifex grassland and woodland predominate on deep soils; spinifex grass with scattered scrub is common in flat, open, soil-filled drainages.

Tributaries of the Hamilton River cut across the mining lease, the most important being Trepell Creek. These watercourses are ephemeral and often anastomosing, comprising multiple channels in a floodplain. These are subject to intermittent and potentially extreme flooding.

The Yurbi rail load out facility is drained by two small, ephemeral tributaries of the Flinders River.

4.3.3 Land use

The majority of soils in the area are cracking and self-mulching clays, with some alluvial non-cracking clay soils associated with the Hamilton River floodplain. The land is not suitable for cultivation or high intensity pastoral use, although extensive sheep and cattle grazing has occurred on the mixed species grasslands in the area since 1878.

The area of land actually disturbed by the mine, process plant, village, airstrip and all the other structures and buildings relating to the Cannington is about 465 ha. A fenced exclusion area totalling approximately 1,500 ha separates the operation from the rest of the area held under tenure, which is utilised through agreement by an adjoining local pastoralist for grazing of stock.

4.4 Ownership and tenure

Australia has an extensive legal framework within which mining, environmental and social aspects are managed. Key statutory legislation relevant to mining operations in Queensland include, but are not limited to:

Queensland legislation

- Mineral Resources Act 1989
- Mineral Resources Regulation 2013
- Mining and Quarrying Safety and Health Act 1999
- Mining and Quarrying Safety and Health Regulation 2001
- Mineral and Energy Resources (Common Provisions) Act 2014
- Environmental Protection Act 1994
- Environmental Protection Regulation 2008
- Lands Act 1994
- Native Title (Queensland) Act 1993
- Queensland Heritage Act (1992)
- Aboriginal Cultural Heritage Act 2003
- Explosives Act 1999
- Transport Infrastructure Act 1994
- Water Act 2000

Commonwealth Legislation

- Commonwealth Constitution
- Airports Act 1996
- Environment Protection and Biodiversity Conservation Act 1999
- Hazardous Waste (Regulation of Exports and Imports) Act 1989
- Native Title Act 1993
- Protection of Moveable Cultural Heritage Act 1986
- Water Act 2007

4.4.1 Mineral tenure

BHP Billiton holds a 100 per cent interest in BHP Billiton Minerals Pty Ltd, the registered holder of a 100 per cent interest in the tenements listed below.

The Cannington Asset mineral interests comprise three granted MLs and 13 granted EPMs as summarised in Table 4.1. The mineral extraction and processing aspects of the Cannington Operations are held under two MLs, with the underground mine and infrastructure located on ML90059, and the borefield, associated services and access corridors located on ML90060. A third lease, ML90077, encompasses the Yurbi railhead loading facility near Cloncurry.

Importantly, the Cannington deposit is entirely contained within ML90059. ML90059 conveys the mining rights to silver, arsenic, gold, bismuth, cadmium, clay, copper, iron ore, fluorite, germanium, gravel, limestone, lead, quartz, rock, sand and zinc until 31 December 2029. Similarly, ML90060 conveys the mining rights to silver, copper, gravel, limestone, lead, quartz, rock, sand and zinc until 30 June 2030. ML90077 held in support of transportation infrastructure associated with the Cannington Operations and does not impart any mining or exploration rights to minerals.

The general conditions of a ML or EPM are stated in the *Mineral Resources Act 1989*. Key aspects of this Act include:

- Ownership of minerals vests to the Crown (i.e. the Queensland State Government);
- A royalty is payable to the Crown for the right to extract minerals;
- A mining lease is the most important tenure as it allows the extraction of minerals;
- Exploration permits and mining leases may be granted over private land without the owner's consent but are subject to compensation for loss of use of the land;
- Mining is prohibited in a national park or conservation park; and
- Mines require an environmental authority (mining lease) under the *Environmental Protection Act 1994 (Qld)* to operate.

The MLs were surveyed by marking the land with a post at each corner and one of the posts was selected as the datum for commencement of the lease. The boundaries of the leases are described by accurately measured distances and compass bearings on the ground. Exploration permits are defined by one minute of latitude by one minute of longitude graticule areas referenced by way of block and sub-block identification.

Table 4.1: Cannington Asset exploration and mining tenements (October 2014)

Title	Tenement Name	Area	Grant Date	Expiry Date	Rent
Mining Leases					
ML90059	Cannington ML	7,862 ha	15/12/1994	31/12/2029	426,906.60
ML90060	Cannington Borefield Lease	599 ha	08/06/1995	30/06/2030	32,525.70
ML90077	Yurbi	189.9 ha	07/12/1995	31/12/2030	10,317.00
Exploration Permits					
EPM6788	Answer Downs	72 blk	28/11/1989	27/11/2015	10,123.20
EPM11675	Balaclava	2 blk	25/07/2003	24/07/2016	281.20
EPM17257	Lucknow South	30 blk	28/03/2011	27/03/2016	4,218.00
EPM17569	Sheep Creek	60 blk	24/05/2011	23/05/2016	8,436.00
EPM17656	Cannington West 2	33 blk	21/11/2012	20/11/2017	4,639.80
EPM17995	Cannington North 2	23 blk	06/03/2013	5/03/2016	3,233.80
EPM18324	Lucknow Bore	36 blk	21/04/2011	20/04/2016	5,061.60
EPM19038	Cannington North	1 blk	28/06/2012	27/06/2017	140.60
EPM25169	Mackunda Downs	100 blk	07/04/2014	6/04/2017	14,060.00
EPM25170	Chiltern Hills	56 blk	07/04/2014	6/04/2017	7,873.60
EPM25171	Glen Urquhart River 2	4 blk	08/04/2014	7/04/2017	562.40
EPM25173	Glen Urquhart River 1	4 blk	12/08/2014	11/08/2017	562.40
EPM25474	Lucknow East	100 blk	04/08/2014	4/08/2019	14,060.00
Total					543,001.90

Source: BHP Minerals, MinesOnline

NB: blk = sub-block, which is equivalent to approximately 3.18 km² at Cannington Operations latitude.



Two recurring expenses are annual rentals for all mineral tenures and local council rates on the MLs. The annual rentals totalled AUD469,749 for the Cannington Asset's MLs. Annual rentals for Cannington Asset's EPMs is currently AUD73,252. McKinlay and Cloncurry Shire rates for Cannington Asset's MLs total approximately AUD182,800 annually.

4.4.2 Other land tenure

Major activities associated with mining at the Cannington Operations, (mining, processing, and part of the remote borefield water supply) occur within McKinlay Shire, while the Yurbi Rail Loadout facility and remaining larger part of the remote borefield is in Cloncurry Shire. The Townsville Port Facility is in the Townsville City Council local government area.

The Cannington Operation is located on Trepell Holding (owned by BHPB Minerals and also known as Cannington Special Lease). The borefield lies on El Rita Holding and Toolebuc Holding (owned by a neighbouring pastoralist) to the east of the mine site.

Other background tenures to the Cannington ML include a communications tower lease Lot 2 on MN17, Water Reserve and Camping Lot 3 on MN15, and SL13/53195 Lot 1 on Plan 865897. The Cannington deposit is contained within Special Lease SL13/53195 (Lot 1 on CP865897), which was granted to BHP Minerals Pty Ltd on 21 July 1994. This special lease, granted under the *Lands Act 1994* expires on 20 July 2044.

The Yurbi railhead loading facility is located within Martindale Preferential Pastoral Holding Lot 4105 on PH2186, which along with Lot 2831 on CP PH161, Lot 1 on MPH4396 and Lot 1 on CP MPH21883 is known as Fishers Creek Station.

In addition, two lots (Lot 159 and 160) are leased from the Townsville Port Authority at the port and a third (Lot 161) is used under a licence to occupy.

Annual Council property rates associated with Cannington Operations and Yurbi land holdings total AUD284,346 and land rent payable to the DNRM total AUD31,170.

Annual lease and other fees associated with the Townsville Port are AUD286,208 and AUD158,631 respectively.

4.4.3 Royalties

The Queensland State mineral royalty for lead, zinc and silver consists of a sliding scale varying between 2.5 per cent and 5.0 per cent (in 0.02 per cent increments) based on average metal prices.

There is no previous owner royalty or commitments to third parties based on mineral sales.

4.4.4 Agreements

EPM11675 is the subject of an alliance between BHP Billiton and Exco Resources Limited ("Exco"), a subsidiary company of Washington H Soul Pattinson & Company Limited, a diversified investment company listed on the ASX. The agreement commenced in 1998 and pertained to certain tenements in the Cloncurry area. The majority of these tenements have now been relinquished or retired from the alliance. Under the terms of the agreement, BHP Billiton had to earn the right to develop any subsequent discoveries under a royalty agreement with Exco of between 1 per cent and 1.5 per cent of Net Smelter Returns ("NSR"). BHP Billiton would earn no interest in the tenements unless a discovery is made and defined as a resource. Under the terms of the agreement, Exco holds the rights to all copper and gold mineralisation. Cannington Asset recently completed an evaluation of EPM11675 and is currently in discussions with Exco regarding the exploration strategy going forward.

EPM6788 is the subject of the Soldiers Cap re-alignment and farm-in agreement, which was executed in 2001 between BHP Billiton and Exco. Under the terms of the agreement, BHP Billiton transferred its Soldiers Cap Project tenements to Exco in exchange for BHP Billiton being granted the rights to explore for selected targets involving a minimum expenditure of AUD200,000. If BHP Billiton applied for a Mineral Development Licence, Exco would receive a royalty equivalent to 2.75 per cent of the cash flow from any future production, including an up-front payment of 30 per cent of the net present value of the royalty. Currently, Exco explores the northern portions of EPM6788, while BHP Billiton explores the portion of the permit in close proximity and to the south of the Cannington ML.

4.4.5 Native Title

Details relating to Native Title are discussed in Section 4.17.3.

4.4.6 Licences and authorisations

Details relating to licences and authorisations are discussed in Section 4.17.4.

4.4.7 Contracts

Cannington Asset has entered into various contracts including, but not limited to:

- Conduct and compensation agreements with the McKinlay Shire Council (for certain roads and reserves) and various other landholders (mainly pastoral lease holders)
- Agistment licences
- Gas and water supply contracts
- Consumables supply including fuels and lubricants, cement and reagents
- Transport agreements including rail haulage and aviation transport services
- Various asset management and engineering supply/services contracts
- Accommodation and Security
- Concentrate sales agreements
- Community/partnership and donation agreements.

Xstract has carried out a high-level review of Cannington Asset's material contracts and considers them broadly in line with industry practice and supportive of on-going operations. Xstract understands that full details regarding the legal status of Cannington Asset's contracts are provided elsewhere within the Listing Documents.

4.4.8 Legal claims and litigation

Xstract has not been made aware of any legal claims or litigation pertaining to the technical, operational or cost aspects of the Cannington Asset going forward.

4.5 History

The Cloncurry area has been the subject of exploration and mining activities by numerous of companies over the past 100 years.

Early maps indicate that the Cannington Operations site was originally part of the Toolebuc No 8 Pastoral Lease, which was first settled by Europeans in 1879. Cannington station (comprising Lily Downs and Trepell Holdings) was drawn in a ballot and then purchased in 1928 and an adjoining pastoral lease, Inverarvon, purchased in 1934.

Modern exploration of the region commenced in the 1950s, with regional surveys by State and Federal government geological agencies, as well various base metal and precious metal exploration activities carried out over the district since that time.

In the early 1980s, BHP Minerals identified the Eastern Succession of the Mount Isa Inlier as having potential for Broken Hill-type ("BHT") lead-zinc-silver deposits. Initial exploration focussed on Mesoproterozoic-aged Soldiers Cap Group, which proved encouraging and eventually led to the discovery of the Eloise copper-gold and Altia lead-zinc deposits (now held by third parties), before exploration efforts were shifted to the Cannington area.

Exploration in the Cannington area involved detailed airborne and ground magnetic surveying and limited drilling, which resulted in the discovery of the Cannington deposit in 1990. Further exploration drilling was completed during the 1991 season and was followed by resource evaluation and a decision to proceed to a pre-feasibility study in 1992. The pre-feasibility was successfully completed in late 1992 and resulted in the opening of an underground exploration decline to further investigate the resource shortly thereafter. The feasibility study was completed in 1995, which led to underground mine development and surface construction activities commencing in May 1996.

Mine site construction was completed on schedule, with mine production starting in May 1997 and the first production of concentrate on 3 October 1997. The commissioning of the permanent ore handling facilities in May 1998, allowed Cannington Operations to ramp up to its nameplate mining and processing capacity of 1.5 Mtpa of ore. This was increased to 1.8 Mtpa shortly afterwards following a de-bottlenecking strategy.

The construction of a concentrate handling facility commenced at the Port of Townsville in August 1996 and was completed on schedule with the shipment of first concentrate in January 1998.

During the first six years, operational capacity was increased via a series of both milling and mining debottlenecking projects. In February 2003, approval was received to increase the sustainable capacity to 2.4 Mtpa. Subsequent upgrades, optimisation and expansions lifted the operating capacity to approximately 3.4 Mtpa.

Production since 1998 is summarised in Table 4.2.

Cannington Operations is a mature operation, two-thirds the way through the current expected mine life. Material increases in the underground mine production rate are considered unlikely. As the mine matures, the average stope size decreases, increasing the number of stopes mined each year required to sustain production capacity.

The current mine plan schedules closure of the mine in 2023 and includes an additional 6 Mt above the published Ore Reserve. The majority of this (5 Mt) is accounted for in two extension blocks to the North Zone (North Upper and North Outer) which are currently in the evaluation stage. The remaining tonnes are within the designed stope wireframes but have been classified as an Inferred Resource and subsequently excised for Ore Reserves reporting purposes.

Table 4.2: Cannington Asset's production since commissioning

Year	Ore Milled Tonnes (t)	Average Lead Head Grade	Payable Lead Metal Production	Average Zinc Head Grade	Payable Zinc Metal Production	Average Silver Head Grade	Payable Silver Metal Production
End June 2014	1,600,000	7.09%	92,982 t	2.76%	25,740 t	298 g/t	12.49 Moz
2013	3,181,000	7.74%	209,111 t	3.22%	63,407 t	338 g/t	29.09 Moz
2012	3,189,000	7.81%	214,606 t	2.64%	50,474 t	365 g/t	32.23 Moz
2011	3,213,000	8.47%	232,431 t	3.05%	59,710 t	365 g/t	32.17 Moz
2010	3,075,000	9.71%	256,142 t	3.21%	59,372 t	459 g/t	38.60 Moz
2009	3,031,000	8.81%	225,984 t	3.20%	59,715 t	412 g/t	33.76 Moz
2008	3,025,000	9.39%	241,437 t	3.25%	59,627 t	423 g/t	34.56 Moz
2007	2,808,000	10.48%	256,825 t	3.35%	56,440 t	484 g/t	37.47 Moz
2006	2,354,000	10.05%	209,692 t	3.74%	55,043 t	417 g/t	27.72 Moz
2005	3,156,000	10.32%	287,611 t	3.33%	60,885 t	500 g/t	43.92 Moz
2004	2,977,000	10.59%	271,729 t	3.24%	52,006 t	507 g/t	41.32 Moz
2003	2,336,000	11.46%	232,675 t	4.23%	60,501 t	534 g/t	34.40 Moz
2002	2,305,000	12.47%	246,298 t	4.27%	57,416 t	598 g/t	38.18 Moz
2001	1,946,000	12.80%	209,528 t	5.30%	70,574 t	573 g/t	31.10 Moz
2000	1,708,000	14.18%	210,809 t	5.03%	66,933 t	648 g/t	32.25 Moz
1999	1,466,429	12.55%	150,073 t	4.76%	44,000 t	571 g/t	22.09 Moz
1998	681,000	14.10%	72,835 t	5.40%	18,803 t	696 g/t	11.52 Moz
TOTAL	42,051,429		3,620,768 t		920,646 t		532.86 Moz

Source: Intierra, company announcements

4.6 Geological setting

4.6.1 Regional geology

The Cannington deposit lies within the Proterozoic Mount Isa Inlier, a diversely mineralised, deformed and metamorphosed terrain in northwest Queensland. The inlier is subdivided into three main blocks by major north-striking fault zones, namely the Western Succession (or Western Fold Belt), the central Kalkadoon-Leichardt Province and the Eastern Succession (or Eastern Fold Belt). The Eastern Succession comprises an Archean-Proterozoic basement of metamorphic rocks variably overlain by three volcano-sedimentary cover sequences, which range in age from 1850 to 1670 Ma.

Two major tectonic events are recognised – the Barramundi Orogeny (around 1870 Ma) and the Isan Orogeny. Of most importance to the Cannington area is the Isan Orogeny, which occurred between 1590 and 1500 Ma. This orogeny is characterised by four deformation events and two metamorphic events. Peak metamorphism was defined by low pressure-high temperature conditions, and coincided with the second main deformation event (D_2). The present structural pattern is evident as steeply dipping, north-trending folds and faults.

The Cloncurry-Selwyn zone of the Eastern Succession comprises an interlayered sequence of extensively deformed meta-sedimentary units, with some metavolcanics, intruded by granitoids and dolerites of the Williams Batholith.

The Cannington deposit lies within high-grade metamorphic rocks of the Soldiers Cap/Fullarton River Groups, part of the Maronan Supergroup, to the east of the Cloncurry Overthrust (Figure 4.4). The Soldiers Cap/Fullarton River Groups are interpreted to form part of regional Cover Sequence 3 and are dominated by gneiss, schist, quartzite, feldspathic quartzite and thin banded iron formation ("BIF"). In addition to turbiditic rocks, the Groups contain significant amphibolite and metabasalt, along with minor felsic volcanoclastic rocks.

The depositional age of the Soldiers Cap Group is 1712 to 1654 Ma, while the main phase of deformation and metamorphism coincides to the Isan Orogeny, associated with the emplacement of the Williams Batholith. These rocks have been subjected to greenschist to upper amphibolite facies metamorphism. Recent interpretation suggests the Soldiers Cap and Fullarton River Groups can be directly correlated with apparent mineralogical differences reflecting increasing metamorphic grade in the Fullarton River Group relative to the Soldiers Cap Group.

Most of these prospective Proterozoic basement rocks in the Cannington area, and to the south of Cannington, are covered by a variable thickness of flat-lying Mesozoic sediments assigned to the Eromanga Basin, with a progressive increase in thickness and depth to Proterozoic basement southward. This has forced most of the previous and current exploration companies in the area to rely heavily on the use of geophysical surveying as the main exploration tool. The Cannington deposit lies under approximately 60 m of cover.

Figure 4.4: Simplified geological framework of the Mount Isa Inlier

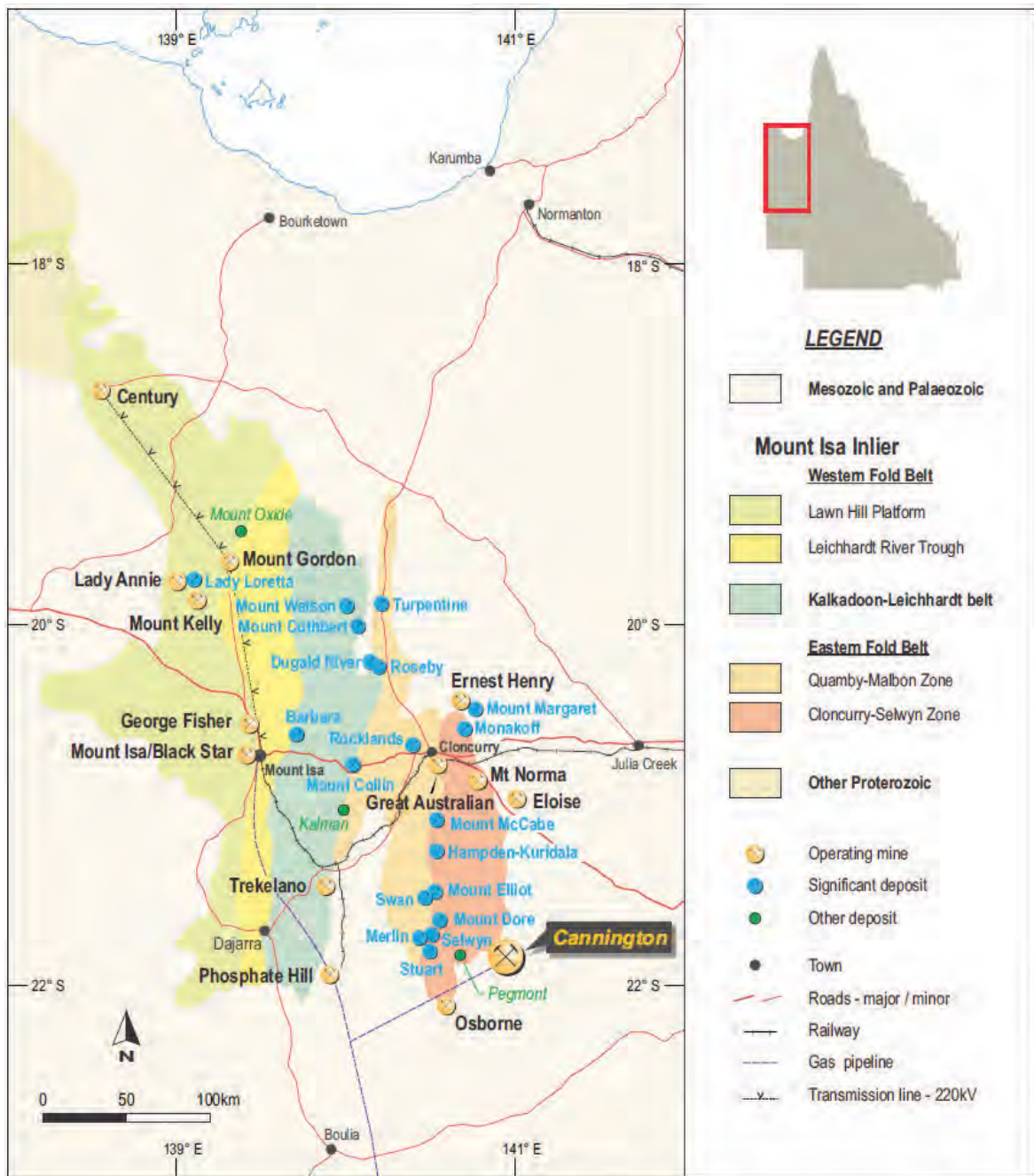

Source: Modified after Queensland Mining (2006)

4.6.2 Mineralisation of the Mount Isa Inlier

The geological setting of mineralisation in the Mount Isa Inlier is diverse in terms of genesis, host rocks, age and metal content. Important styles of mineralisation recognised include, but are not limited to:

- Iron-oxide copper-gold deposits such as at Ernest Henry, Osborne and Starra.
- Metasomatic copper-gold deposits as seen at Mount Elliott and Kuridala with the mineralisation hosted within altered and mineralised carbonaceous shales.
- Sediment-hosted silver-lead-zinc deposits as represented by Dugald River which is hosted in carbonaceous shales.

- Broken Hill Type silver-lead-zinc deposits occurring in high grade metamorphic rocks as at the Cannington deposit.
- High-grade gold-only deposits within deformed banded meta-sedimentary units such as at Tick Hill.
- Secondary copper (cobalt, gold) deposits occurring in the near surface environment above primary sulphide mineralisation of which there are numerous examples throughout the region with the Mount Dore deposit being typical.
- Both palaeochannel and hard rock uranium deposits, with the latter represented by Mary Kathleen deposit, which is hosted within garnetiferous breccia conglomerate near the contact with granite.

4.6.3 Local geology

The Cannington mineralisation is hosted within a 70 m to 90 m thick of interbedded garnetiferous psammite and basic volcanic units that enclose a fine to medium-grained central amphibolite body up to 100 m thick. The psammite is itself intercalated with muscovite-sillimanite schist and enclosed by migmatitic quartzo-feldspathic gneiss. Pegmatite horizons that are semi-conformable within the deposit sequence are thought to be predominantly the result of partial melts of clastic rocks within this package (Mark, 1993).

Structure

The psammite sequence is folded into a tight, northerly striking isoclinal recumbent fold that plunges to the south with limbs dipping between 40° and 70° to the east as the result of the second of four structural events (D1 to D4) described by Bailey (1998). Two major northwest trending D4 faults offset the sequence. The Trepell Fault divides the 'Northern Zone' from the 'Southern Zone' and the Hamilton Fault forms a southern limit of the 'Southern Zone' (Figure 4.5). This Proterozoic host sequence is truncated up-plunge in the Northern Zone at the sub-horizontal unconformity with the younger Cretaceous sediments that are between 10 m and 60 m thick in the Cannington Operations area.

Figure 4.5: Interpreted geology at 900 mRL (350 m below surface)

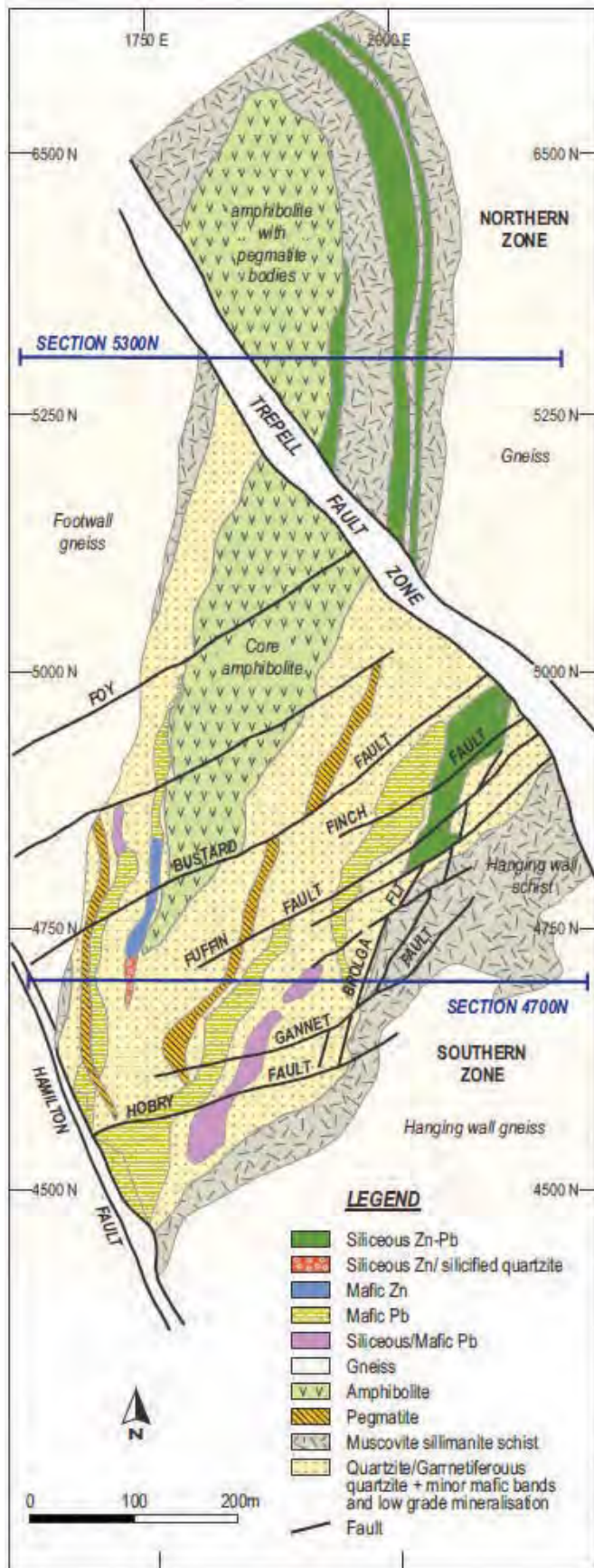

Source: Modified from Bailey (1998)

The Southern Zone has a strike length of 600 m to 700 m and extends to approximately 650 m below surface. The metamorphosed sediment package has been folded into a synform structure and is displaced on a local scale by north-northeast and northeast trending faults (Figure 4.5 and Figure 4.6). The northeast trending faults are interpreted as conjugate sets to the Trepell and Hamilton Faults as a result of sub-horizontal sinistral movement.

Figure 4.6: Interpreted geology section of the Southern Zone at 4700 mN looking north

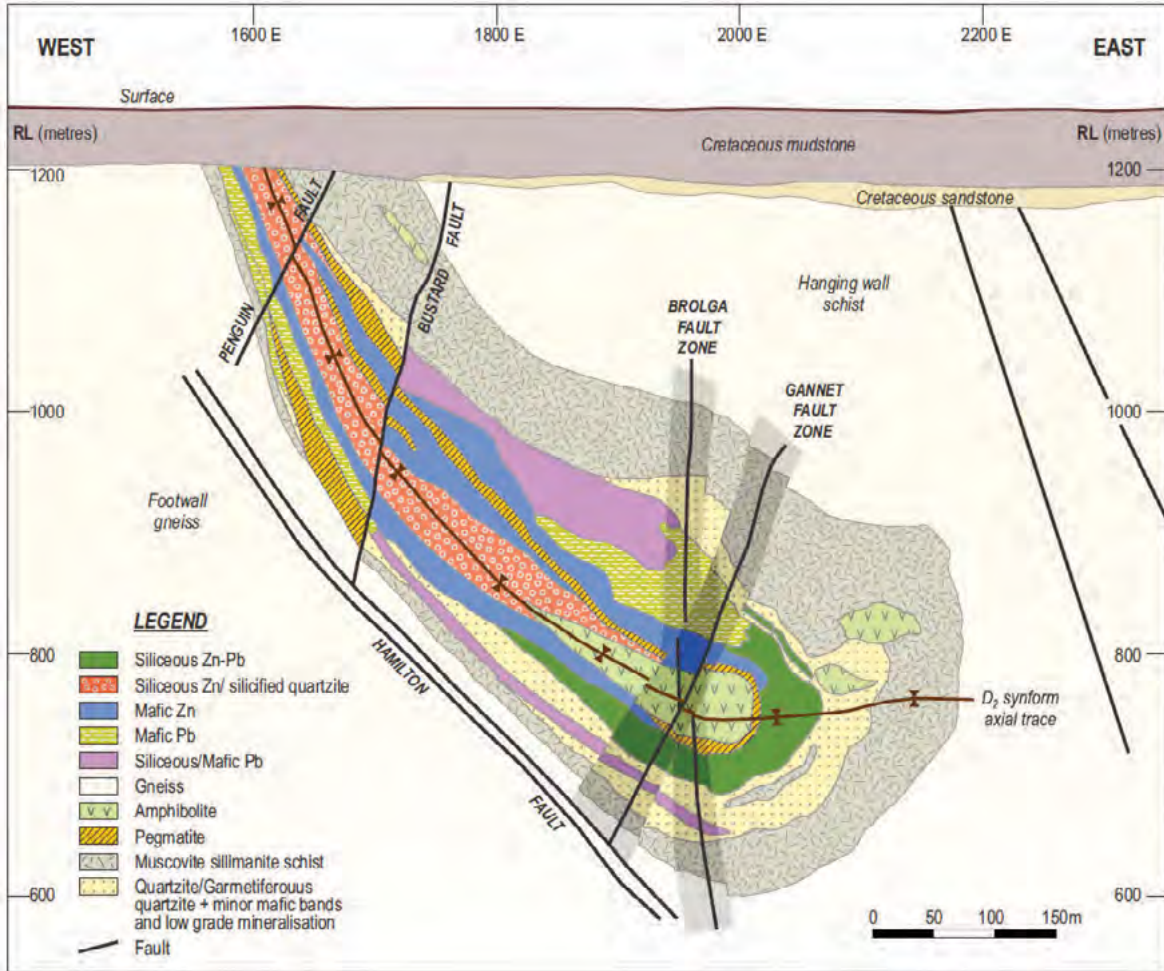

Source: Modified from Bailey (1998)

The Northern Zone strike is approximately 500 m and extends to around 400 m below surface. It is less deformed than the Southern Zone and typically dips east, interpreted as being the eastern limb of an antiform (Figure 4.7).

Figure 4.7: Interpreted geology section of the Northern Zone at 5300 mN looking north

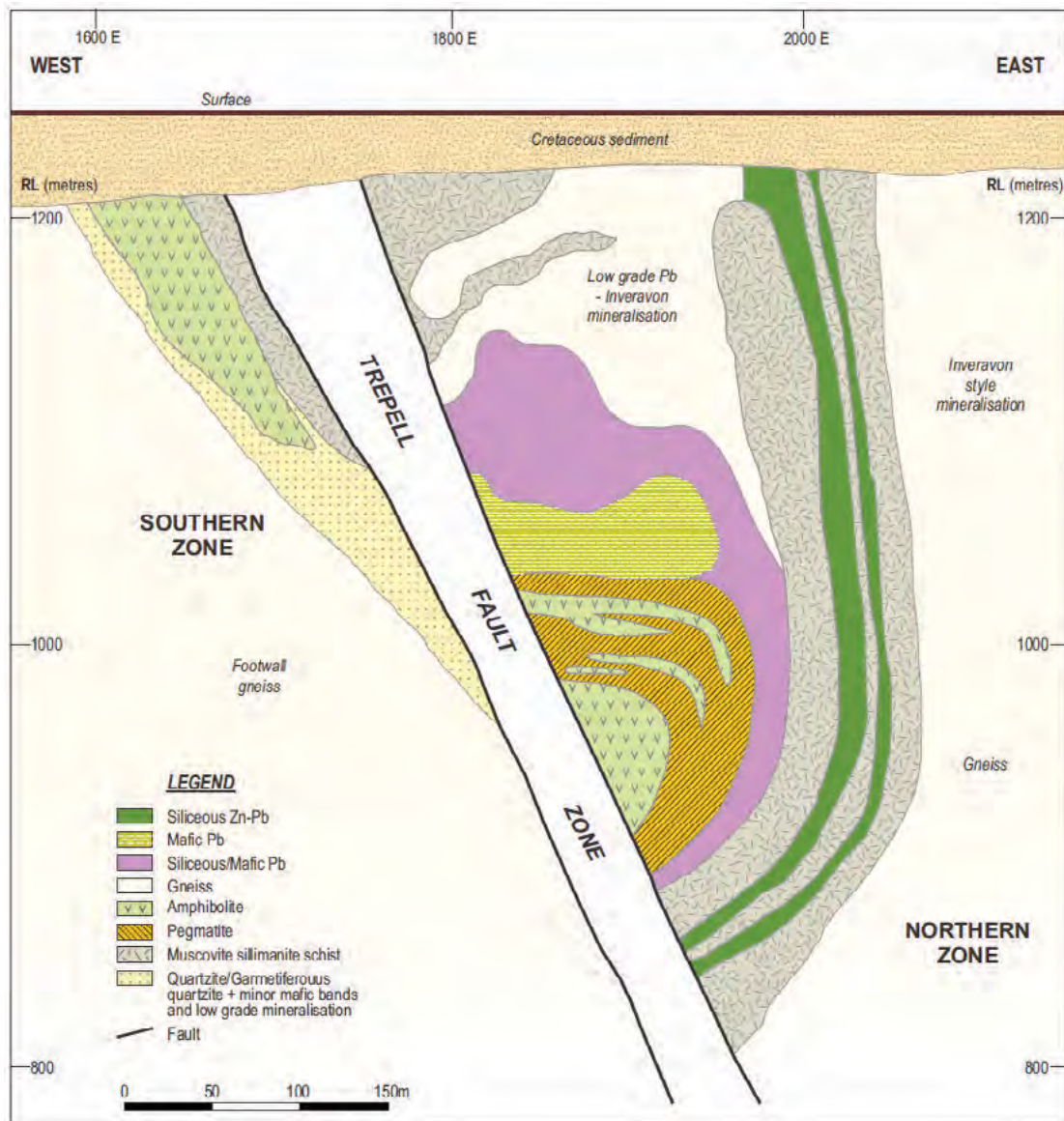

Source: Modified from Bailey (1998)

Mineralisation

Silver, lead and zinc mineralisation is stratiform within the garnetiferous psammite and mafic host rocks and varies in textural, mineralogical and geochemical characteristics that have been classified as 'mineralisation types'. These are divided into footwall (western limb), hangingwall (eastern limb) and fold hinge lead-rich and zinc-rich domains (Figure 4.8), with the mafic rocks more complex in mineralogy than the siliceous rocks as mineralisation grades from outer Pb-Ag to inner zinc zones. The sulphide mineralogy is dominated by coarse grained galena (PbS), sphalerite (ZnS), with silver mainly contained in freibergite ($Cu_6(Ag,Fe)_6Sb_4S_{13}$).

Figure 4.8: Mineralisation styles and trends nomogram

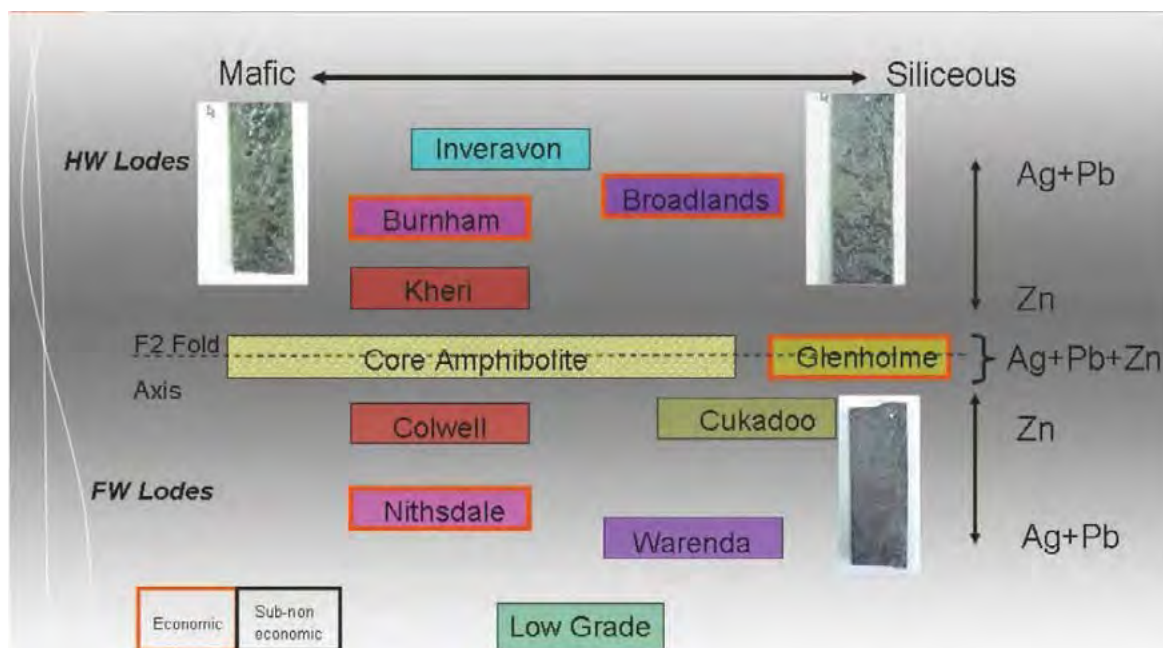

Source: Cannington Asset

Bailey (1998) suggests the possible genetic models for mineralisation are similar to those of Broken Hill in terms of setting in the Middle Proterozoic, lithology, deformation, metamorphism and distinct geochemical, mineralogical and economic mineral zoning. Syn-sedimentary mineralisation with modification and remobilisation during metamorphic and deformation episodes or late stage metasomatic (skarn style) mineralisation post-dating major metamorphic and deformation events are both suggested.

4.7 Mineral Resource and Ore Reserve statements

This report includes information on Mineral Resources (inclusive of Ore Reserves) as reported by: B Coutts (MAusIMM) and Ore Reserves as reported by: M Dowdell (MAusIMM). The information is extracted from the report titled BHP Billiton 2014 Annual Report and is available to view on www.bhpbilliton.com.

All Competent Persons are full-time employees of BHP Billiton at the time of reporting and have the required qualifications and experience to qualify as Competent Persons for Mineral Resources under the 2012 Edition of the "Australasian Code for Reporting of Exploration Results, Mineral Resources and Ore Reserves" ("JORC Code"). The Competent Persons verify that the report is based on and fairly reflects the Mineral Resources and Ore Reserves information in the supporting documentation and agree with the form and context of the information presented.

BHP Billiton confirms that it is not aware of any new information or data that materially affects the information included in the original market announcements and, in the case of estimates of Mineral Resources and Ore Reserves, that all material assumptions and technical parameters underpinning the estimates in the relevant market announcements continue to apply and have not materially changed. BHP Billiton confirms that the form and context in which the Competent Persons' findings are presented have not been materially modified from the original market announcements.

The Mineral Resources and Ore Reserves breakdown by classification (100 per cent basis) are contained in Table 4.3. All tonnes and quality information has been rounded, hence small differences may be present in the totals.

4.7.1 Mineral Resources

The Mineral Resource as at 30 June 2014, reported inclusive of the Ore Reserve, is 82.7 million tonnes at 170/t silver, 5.1 per cent lead and 3.2 per cent zinc. The Mineral Resource is reported in two components relating to proportions of the Mineral Resource potentially extractable by open pit and underground mining methods and within resource confidence classification criteria as described in the JORC Code (Table 4.3).

In order to estimate the Mineral Resource as at 31 December 2014, the Ore Reserves as at 30 June 2014 were depleted to account for actual production to 31 October 2014, as well as forecast production from 1 November to 31 December 2014. The Cannington Mineral Resources (as at 31 December 2014, Table 4.4) were estimated to support a valuation of the Ore Reserves at a point as close as practical to the final sign-off of this Competent Persons Report by reducing the Measured Resource for the 30 June 2014 estimate by the Ore Reserves depletion amount for the same period (1.7Mt at 249 g/t Ag, 6.78% Pb and 3.29% Zn).

The Mineral Resource estimate meets the criteria for reasonable prospects for eventual economic extraction through the application of a cut-off value applied to an estimate of the in-situ value of the contained metal at the mine gate after distribution, treatment, refining and royalty costs has been deducted ("Dolbee"). Reporting cut-off values essentially reflect mining, haulage, processing and general and administrative costs, that is then inflated to cover the risk of possible commodity price falls, and which, for open pit and underground methods, are AUD45 and AUD90 respectively. The underlying commodity price assumptions are USD23.16/oz for silver, USD1.38/lb for lead and USD1.27/lb for zinc and AUD:USD exchange rate of 0.93. The Dolbee value is reported on value per dry metric tonne basis.

Table 4.3: Cannington Mineral Resource as at 30 June 2014 in 100 per cent terms

Open Pit	Tonnes (Mt)	Silver (g/t)	Lead (%)	Zinc (%)
Measured	13	93	3.80	2.26
Indicated	7	64	2.76	1.96
Measured + Indicated	20	83	3.43	2.16
Inferred	-	-	-	-
Total	20	83	3.43	2.16

Cut-off AUD45/dry metric tonne - Dolbee

Underground	Tonnes (Mt)	Silver (g/t)	Lead (%)	Zinc (%)
Measured	44	226	6.20	3.82
Indicated	12	148	4.51	3.04
Measured + Indicated	56	209	5.84	3.65
Inferred	7	100	3.56	2.02
Total	63	198	5.61	3.48

Cut-off AUD90/dry metric tonne - Dolbee

Combined	Tonnes (Mt)	Silver (g/t)	Lead (%)	Zinc (%)
Measured	57	196	5.65	3.46
Indicated	19	117	3.87	2.64
Measured + Indicated	76	176	5.21	3.26
Inferred	7	100	3.56	2.02
Total	83	170	5.07	3.15

Source: BHPB Minerals

Table 4.4: Cannington Mineral Resource as at 31 December 2014 in 100 per cent terms

Open Pit	Tonnes (Mt)	Silver (g/t)	Lead (%)	Zinc (%)
Measured	13	93	3.80	2.26
Indicated	7	64	2.76	1.96
Measured + Indicated	20	83	3.43	2.16
Inferred	-	-	-	-
Total	20	83	3.43	2.16

Cut-off AUD45/dry metric tonne - Dolbee

Underground	Tonnes (Mt)	Silver (g/t)	Lead (%)	Zinc (%)
Measured	43	225	6.20	3.84
Indicated	12	147	4.50	3.04
Measured + Indicated	55	208	5.83	3.67
Inferred	7	99	3.55	2.01
Total	61	197	5.57	3.49

Cut-off AUD90/dry metric tonne - Dolbee

Combined	Tonnes (Mt)	Silver (g/t)	Lead (%)	Zinc (%)
Measured	56	194	5.64	3.47
Indicated	19	116	3.86	2.64
Measured + Indicated	75	175	5.19	3.26
Inferred	7	99	3.55	2.01
Total	82	168	5.05	3.16

Source: BHPB Minerals

Approximately 65 per cent of the potentially open pit resource tonnage (70 per cent of contained metal) is reported as a Measured Resource and the balance as an Indicated Resource, while 70 per cent of the underground resource (80 per cent of contained metal)

is categorised as Measured, 18 per cent of tonnage (15 per cent of contained metal) as Indicated and the balance as an Inferred Resource.

Changes to the previous year (i.e. 2013) amount to a net reduction of approximately 11 per cent in contained metal (50 Moz in contained silver, 500 kt in contained lead metal and 300 kt in contained zinc metal), due primarily to mining depletion (3.4 Mt ore) and metal price changes that effectively increase the reporting cut-off grade for the Mineral Resources. Of the latter, changes in the silver price had the greatest impact.

The Cannington Mineral Resource is reported in accordance with the JORC Code and was prepared by the BHP Billiton-nominated Competent Person for the Cannington Mineral Resource reporting, Mr Ben Coutts. Mr Coutts was employed by BHP Billiton, as a Manager Resource Planning at the time.

Mr Matthew Readford, of Xstract, who is a Chartered Professional (Geology) and Member of the Australasian Institute of Mining and Metallurgy has reviewed the Cannington Mineral Resource estimate and is satisfied that it is representative and can be reported as the Mineral Resource for the Cannington Operations. In forming this view, Xstract has reviewed the resource model, informing data and estimation process to confirm it is appropriate for the deposit, and that the classification and reporting complies with the JORC Code.

The geological, grade and density data sourced from drill holes is considered suitable for use in developing the Mineral Resource estimate. The base data used in the resource estimate is summarised below.

The Mineral Resource estimate is based on 6,470 surface diamond, RC, and underground diamond drill holes completed between 1990 and 2011, of which 85 per cent is underground drilling (Table 4.5). Approximately 810,000 m of LTK60 (43.9 mm), NQ (47.6 mm), NQ2 (50.7 mm) and HQ (63.5 mm) drill core informed the geological model and grade density estimation. There has been 699 underground diamond drill holes completed since 2011 (approximately 76,000 m) that could potentially contribute to future Mineral Resource estimates.

Table 4.5: Number and type of drillholes used for the FY14 Mineral Resource estimate

Hole Type	Number of Drillholes	Metres of Drilling
Surface diamond	883	239,914
Surface RC	74	9,031
Underground	5,513	561,178
Total	6,470	810,123

Source: Cannington Asset

Drill spacing is designed to intersect mineralisation at high angles to mineralisation trends. The majority of drilling is infill underground drilling spaced on 12.5 mN sections and drilled in fan patterns to intersect mineralisation at approximately a 15 m vertical spacing.

Drill collar positions are measured by surveyors and drillhole paths are generally surveyed at 30 m intervals down the hole (in earlier years of mine development) and then 3 m intervals with the progression of technology from Eastman cameras to Gyrosmart tools. Reasonably tight tolerances for acceptable hole azimuth and dip deviation in underground drilling ensure a high compliance to drilling design.

Facilities for core processing are of a high standard and the tasks involved include mark-up of drilled core, measurement of core recovery over drill run lengths, rock quality designation ("RQD") for geotechnical modelling, specific gravity, and logging of lithology, mineralisation, structures and alteration. Logging and sampling is currently recorded in

Excel spreadsheets and uploaded into an acquire database. Prior to February 2011, resource modelling data was managed in a Microsoft Access database.

Half core sampling is predominantly on 1 m intervals in mineralised core (which can be readily identified by eye) and is extended to 6 m into adjacent barren material. Sampling is completed on each core metre mark, irrespective of lithology and mineralisation. While this sample delineation is likely to result in small locational modelling errors and assay dilution effects at mineralisation boundaries, the overall impact on the resource estimate is not expected to be significant.

The majority of the core is processed at the Cannington Operations on-site laboratory. A final 20 gram sample is subjected to a two-acid digest and analysed using Inductively Coupled Plasma - Optical Emission Spectrometry ("ICP-OES"). Elements assayed are those of primary economic importance - Ag, Pb, Zn and Fe (for density estimation), as well as elements deleterious to the quality of the concentrate - MgO, As and Bi.

The sample and assay quality assurance and quality control procedures are considered appropriate for ensuring the precision and potential errors in the sample preparation and assay results that supports the use of Ag, Pb, Zn, MgO, Bi, As and Fe assay data for use in Mineral Resource estimation. Some inaccuracy in Fe block grades estimates is expected to occur due to the analytical technique employed at Cannington Operations for Fe analysis. This is expected to impact on the accuracy of dry bulk density estimation, in some cases likely leading to overestimation of tonnages, although not considered by Xtract to be a material amount of the scale of quarterly production rates. The precision and accuracy of the data have also been verified in previous independent reviews conducted on the data collected up to 2005 (Golder, 2011, and Hatch, 2005). Xtract reviewed Cannington Operations' analysis of 4,244 submissions of eight matrix-matched certified reference materials ("CRM") between January 2003 to January 2012 for Ag, Pb and Zn and confirmed the reasonable assay accuracy for these elements and an increasing level of precision over time.

The geological model is constructed from predominantly 12.5 m spaced sectional interpretations of drilling and is based on lithological-structural, grade and geometallurgical criteria.

High-grade lead, silver and zinc grade boundaries are defined to limit the interpolation of essentially massive sulphide grades into lower grade zones of disseminated sulphides and appear to reasonably domain data according to two grade distinct grade populations apparent in the assay data. Geometallurgical interpretations are used to model metallurgical recovery and bulk density and are defined based on grade and grade-ratio relationships between lead, zinc and iron assays. The different 'mineralisation types' are cross-checked against logging codes for spatial consistency.

The volumes of the interpreted domain wireframes are modelled with parent model blocks down to a resolution of 8 mE by 12.5 mN by 8 mRL with sub-celling employed to increase accuracy. Visual inspection of the block model against the various geological model wireframes for lithology, mineralisation type and grade boundaries indicate sufficient modelling resolution to estimate geological volumes accurately.

Grade estimation parameters for Ag, Pb, Zn and Fe are derived from variography of 2 m composites of 1 m assay data that were selected from (only) structural domains and have more than 500 samples.

The level of documentation prevents independent review and validation of variography. Statistical analysis supporting the method of geostatistical analysis and estimation techniques is not documented in the FY14 Mineral Resource Report, as is support for the decision not to top cut the positively skewed grade distributions that are input into Gaussian interpolation routines (ordinary kriging and inverse distance weighting). In

summary, the basis for the analysis of grade distributions and continuity is not presented in sufficient detail to understand the degree of confidence in modelling grade continuity.

Without the ability to assess estimation inputs a greater emphasis on is placed on evaluating the quality of grade estimation through historical mining reconciliation, discussed in more detail later in this section.

Ordinary kriging ("OK") was used to interpolate Ag, Pb, Zn and Fe grades into blocks constrained within low mineralisation boundaries in quartzite host lithology. Inverse distance weighting (power of 2) was employed to interpolate MgO, As, and Bi grades. Grades are estimated on a parent cell dimension of 8 mE by 12.5 mN by 8 mRL into individual domains formed from combinations of grade boundaries, mineralisation type and changes in structural orientation. Sample selection during estimation was controlled through octant search and search ellipse shape and extent constraints.

Grade estimates are validated against drillhole composites for Ag, Pb and Zn on a global scale to check for a general estimation bias by comparing domain mean values; on a sectional (northing) basis to check for local estimation bias; and visually to confirm reasonable replication of grade trends. In general, global mean comparisons between sample and model block grades compare better in the higher grade domains than in the lower grade domains.

Cannington Asset uses regression formulae to estimate dry bulk density for tonnage calculation on a geometallurgical basis from a combination of lithology and block grade estimates of Pb, Zn and Fe. The formulae are derived from specific gravity ("SG") sampling of 10 cm to 30 cm core lengths using the weight in air/weight in water method across the range of mineralisation types and the results of a stope sampling program completed in 2007. Golder (2011) concluded the bulk density estimation approach was reasonable but may introduce a conditional bias where density values are underestimated in areas of extreme grades. Their assessment that the impact would not be material to Mineral Resource estimate is difficult to independently validate as the estimation formulae have since been updated based on results of a stope sampling program and documentation is not available for review.

The Mineral Resource classification is based primarily on the spacing of drill sampling and different drill spacing criteria are applied between resources reported as suitable for extraction by underground and open pit methods (Table 4.6). The data density and level of detail in the geological modelling suggests that the resource classification based solely on drill hole spacing may be overly conservative. It would therefore be expected that after applying a better understanding of grade continuity to the grade estimation and using this knowledge in future classification criteria provides significant potential to increase the quantity of the resource reported in the higher confidence Mineral Resource categories.

Cannington Asset reconciles between the resource model and mill feed (incorporating a metallurgical balance) as well as the saleable concentrate tonnes and grade on a quarterly and annual basis. Annual reconciliation results from 2009 to 2013 are typically within 10 per cent for tonnages, silver, lead and zinc grade, which is consistent with expectations of mining Measured Resources. Quarterly figures show higher variability, up to 30 per cent. Cannington Asset attribute this to the impact of reconciling large stopes at the time they are completed, rather than estimating partial reconciliation for large stopes for each three month period.

Overall, the detail of geological knowledge and high density of sample data is expected to compensate for a simplistic grade estimation approach. Annual reconciliation of the model with mill feed and concentrate production are typically within 10 per cent and support the conclusion that Measured Resources provide a reasonable basis for prediction of Ore Reserves on an annual production basis.

Table 4.6: Drill spacing criteria for Mineral Resource Classification

Extraction Method	Confidence	Northing Spacing	Easting Spacing	RL Spacing
Surface	Measured	12.5	15	15
	Indicated	25	25	25
	Inferred	>25	>25	>25
Underground	Measured	25	25	25
	Indicated	50	50	50
	Inferred	>50	>50	>50

Source: Cannington Asset

The inclusion of an additional 700 drill holes into future Mineral Resource estimates, improvement of grade estimation and block size modelling to facilitate Ore Reserve and mining selectivity optimisation, and integration of geological and grade continuity with Mineral Resource classification all represent significant opportunities for Cannington Asset to increase the size and quality of the Cannington Mineral Resource estimate.

Near mine exploration potential

The structural repetition of Cannington mineralisation in the Northern and Southern Zones provides reasonable support for the existence of additional mineralisation zones both along strike from faulting and across strike from folding. If a pattern of the structural repetition is to be assumed, the area south of the Hamilton Fault and possibly at a greater depth than the Southern Zone are of high prospectivity. Some small areas are currently being mined south of the Hamilton Fault and limited surface and underground drilling has intersected mineralisation so there is already indication that this may be the case. Any structural repetition up-plunge and along strike to the north of the Northern Zone mineralisation is likely to have been eroded prior to the deposition of the Cretaceous sedimentary units. There are a few widely spaced surface exploration holes testing for across strike repetition of folded mineralisation. These have encountered little success to date, although they do not comprehensively rule out the existence of a repeat in the mine sequence.

4.7.2 Ore Reserves

The Cannington Ore Reserve, reported in accordance with the JORC Code, as at 30 June 2014 is summarised in Table 4.7. The Ore Reserves for Cannington Operations were prepared under the supervision of the Mr Mark Dowdell, who is currently employed by BHPB Minerals. These Ore Reserves were based on the Mineral Resources prepared by Mr Ben Coutts, also a BHPB Minerals employee at the time.

The Cannington Ore Reserve estimate was independently reviewed by Mr Tim Horsley, of Xstract. Mr Horsley has had a long association with Cannington Operations (from 1994 to 2008) in consultative roles and has previously visited the mine on a number of occasions, and has a good understanding of the operation.

The review process included:

- verification of the economics and appropriateness of the cut-off grade applied
- a review of the spatial distribution and discussion on extraction plans and schedules
- a review and discussion on the derivation and application of mining extraction factors

- observations made during an underground visit and subsequent discussions on geotechnical issues.

Xstract is of the opinion that the Ore Reserve estimate has been compiled in accordance with the JORC Code and is based on realistic and practical assumptions. Cannington Operations plan aims to maximise the asset value (in net present value ("NPV") terms) and is reflected in the cut-off grades applied. The cut-off grades are regularly reviewed and optimised with respect to the life-of-mine plan.

The Ore Reserve estimate is based on actual ore mined to 30 May 2014 with forecast ore mined to 30 June 2014.

In order to estimate the Ore Reserves as at 31 December 2014, the Ore Reserves as at 30 June 2014 were depleted to account for actual production to 31 October 2014, as well as forecast production from 1 November to 31 December 2014. Cannington Ore Reserves (as at 31 December 2014) were estimated to support a valuation of the Ore Reserves at a point as close as practical to the final sign-off of this Competent Persons Report.

For transparency, the Cannington Ore Reserves as at 30 June 2014 and 31 December 2014 are presented in Table 4.7 and Table 4.8 respectively. All reported Ore Reserves are derived from the underground Mineral Resources. To date, no open pit Ore Reserves have been estimated.

Table 4.7: Cannington Ore Reserve as at 30 June 2014 in 100 per cent terms

Ore type	Proved Ore Reserve				Probable Ore Reserve				Total Ore Reserve			
	Tonnes (Mt)	Silver (g/t)	Lead (%)	Zinc (%)	Tonnes (Mt)	Silver (g/t)	Lead (%)	Zinc (%)	Tonnes (Mt)	Silver (g/t)	Lead (%)	Zinc (%)
Sulphide	18	239	6.38	3.92	2.7	240	6.15	4.01	21	239	6.35	3.93

Source: BHPB Minerals

Table 4.8: Cannington Ore Reserve as at 31 December 2014 in 100 per cent terms

Ore type	Proved Ore Reserve				Probable Ore Reserve				Total Ore Reserve			
	Tonnes (Mt)	Silver (g/t)	Lead (%)	Zinc (%)	Tonnes (Mt)	Silver (g/t)	Lead (%)	Zinc (%)	Tonnes (Mt)	Silver (g/t)	Lead (%)	Zinc (%)
Sulphide	17	237	6.31	3.94	3	240	6.13	4.02	20	237	6.29	3.95

Source: BHPB Minerals

The Ore Reserve estimates are based on an underground open stoping (with cemented backfill) mining method that has been employed since operations commenced at Cannington Operations in 1997.

A NSR cut-off grade of AUD140/t has been applied to define ore. This value was selected in order to maximise the value of the project and was derived from the following parameters:

- Metallurgical recoveries of 87 per cent silver, 86 per cent lead and 79 per cent zinc.
- Metal prices of USD23/ounce of silver, USD1.00/pound of lead and USD0.95/pound of zinc.
- Lead payable metal factors of 95 per cent.
- Silver is 95 per cent payable in Pb concentrate and 70 per cent payable in Zn concentrate following a silver deduction of 3oz/conc t.
- USD/AUD exchange rate of 0.93.

The Cannington Ore Reserve estimates were derived from an inventory of stope design wireframes, which were constructed as part of the ongoing detailed mine planning process. Stope wireframes are updated prior to Ore Reserve reporting to reflect any adjustments in cut-off grade, block model updates, mining depletion and other operational related factors.

A number of filters were applied to the stope wireframe inventory before consolidation into reportable Ore Reserves. These filters include:

- The removal of any stope containing an Inferred Mineral Resource, greater than 30 per cent of the stope tonnage.
- Removing any stopes in the end-of-mine-life tail (that could not economically support the ongoing site fixed costs).
- Removing any stopes in blocks currently under evaluation (e.g. North Outer and North Upper).
- Stopes falling below the AUD140/t cut-off were not considered for Ore Reserves.

The Competent Person reported the Ore Reserves after mining factors have been applied and any Inferred Resource tonnages excised.

The recent Ore Reserve history is shown in Figure 4.9.

Figure 4.9: Cannington Ore Reserve History 2010 to 2014

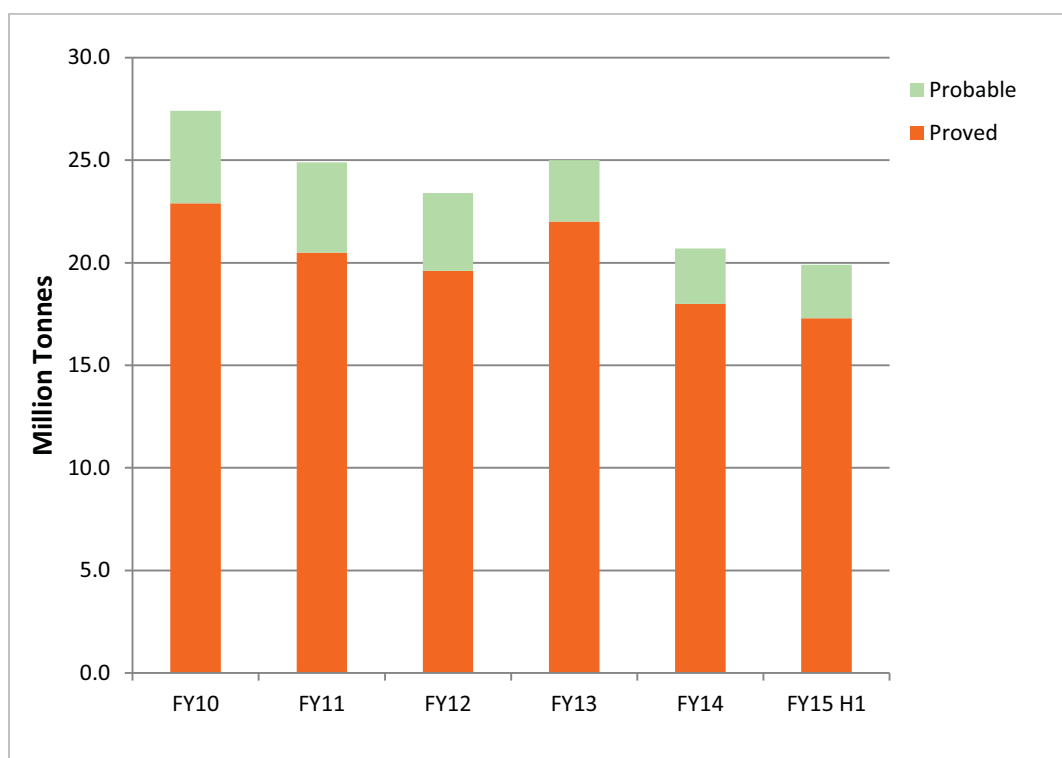

Source: Cannington Asset, Xstract

Reconciliation and modifying factors

Both geological and mining factors are applied to the undiluted reserve estimate. Global geological grade factors of 108 per cent (silver) and 101 per cent (lead) are applied based on reconciliation of the ROM stockpile with the mill.

Mining modifying factors are applied on a block-by-block basis. Mining recovery and dilution factors are derived from historical stope performance. This is achieved by analysing the design stopes and mined stope cavity surveys against the resource block model.

Xstract considers this method may overestimate the grade of the Ore Reserve, primarily as dilution from backfill is likely to increase due to the greater proportion of secondary and tertiary stopes to be mined as the Ore Reserve is depleted.

Other than mining depletion, no material changes to the 2013 Ore Reserve were made for the 2014 estimate.

4.8 Mining

4.8.1 Geotechnical/hydrology considerations

The Cannington deposit is characterised by competent ore with much weaker host rock outside of the orebody. Much of the mine access, ore handling and service infrastructure is located in the amphibolite core of the deposit or within the ore to avoid poor ground conditions. The main orebody (Southern Zone) is separated from the satellite North Zone by a major regional structure, the Trepell Fault. A number of other significant structures impact the mining operations. These are managed primarily by leaving a skin of ore between stopes adjacent to the structure. Mining exclusion zones have been delineated around the crusher, shaft and access infrastructure. Provision has been made in the mine plan for a replacement crusher to allow extraction of high-grade ore within the crusher exclusion zone in 2018.

There are no significant water inflows in the mine other than service water used for the mining operation.

4.8.2 Mining methods and access

Figure 4.10 presents a schematic long-section of the mine. The workings measure 1.2 km (north-south) by 0.6 km to a depth of 650 m below surface.

Figure 4.10: Schematic Long-section of Cannington Operations Underground Mine

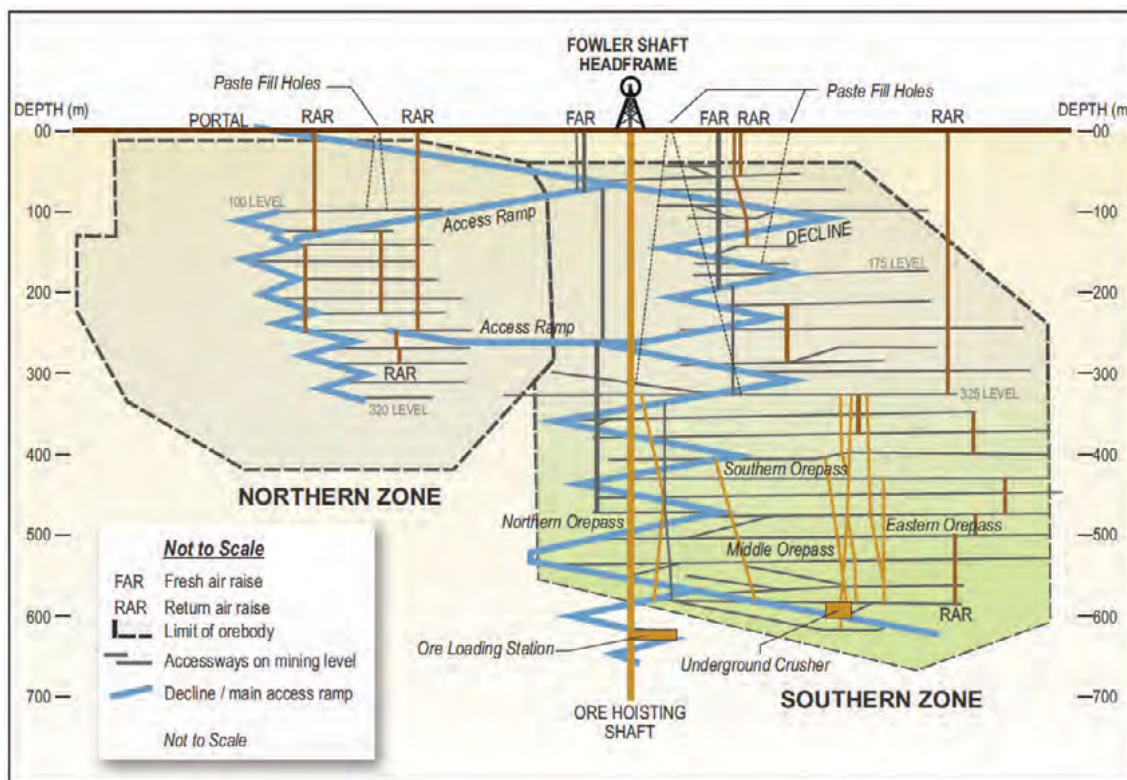

Source: BHPB Minerals

Ore is mined from underground by conventional long-hole sub-level open stoping with cemented backfill. The mine is accessed via a single surface portal with a ramp system extending to a depth of about 600 m into the Southern Zone of the deposit. The Northern Zone is accessed by two sub-ramps connecting into the main Southern Zone decline system.

The stoping areas are accessed by sub-levels developed on a nominal 25 m vertical interval.

A 5.6 m diameter hoisting shaft extends to a depth of 650 m and is equipped with a tower mounted friction winder. The shaft currently hoists about two-thirds of mine production with the remainder trucked to surface using a fleet of 55 t trucks. A number of ore passes, developed in ore, feed to a crusher loading level. Ore is transferred from the passes by a single load-haul dumper ("LHD"). Where passes are not available, ore is trucked directly to the crusher. A conveyor system below the crusher feeds the shaft loading flasks via an ore storage bin.

Emergency secondary egress is provided via the hoisting shaft and ladderways to the surface. A number of self-contained emergency refuge modules are located throughout the mine.

4.8.3 Historical and forecast operating statistics

A summary of key mine operating statistics is shown in Table 4.9 below. Actuals are shown up to H1-FY15.

Table 4.9: Mine operating statistics including Inferred Resources

Year	Ore Mined (dry Mt)	Development Metres (ore)	Development Metres (waste)	Mine Operating Cost (AUD/t ore)
FY 2010	3.13	2,871	4,528	53
FY 2011	3.02	3,039	3,665	55
FY 2012	3.14	2,079	4,135	53
FY 2013	3.05	2,787	4,084	52
FY 2014	3.34	2,305	4,719	52
FY 2015 H1	1.69	1,456	2,131	46
FY 2015 H2	1.70	1,410	2,203	46
FY 2016	3.45	1,734	5,638	48
FY 2017	3.45	1,808	5,667	54
FY 2018	3.16	1,617	5,564	56
FY 2019	3.44	1,738	5,248	52
FY 2020	3.11	1,437	4,758	57
FY 2021	3.11	1,489	4,282	54
FY 2022	3.05	1,576	3,732	50
FY 2023	2.35	1,279	2,481	50

Source: Cannington Asset

4.8.4 Production schedule

The underground mine is at a mature stage of its life, having undergone a number of expansions from the 1.5 Mtpa design capacity at start-up (1997) through to the current 3.4 Mtpa capacity. The mine is planned to operate at current production levels until depletion. Mined ore grades are expected to decline in the final two to three years, as higher grade sources are preferentially extracted.

Figure 4.11 and Table 4.10 below shows the current life-of-mine production forecast. This includes material yet to be classified as an Ore Reserve. The bulk of this (5 Mt) is accounted for in two satellite blocks in the North Zone: North Upper and North Outer. These are currently under evaluation and contain greater than 80 per cent Measured and Indicated Resource.

Figure 4.11: Mine production forecast

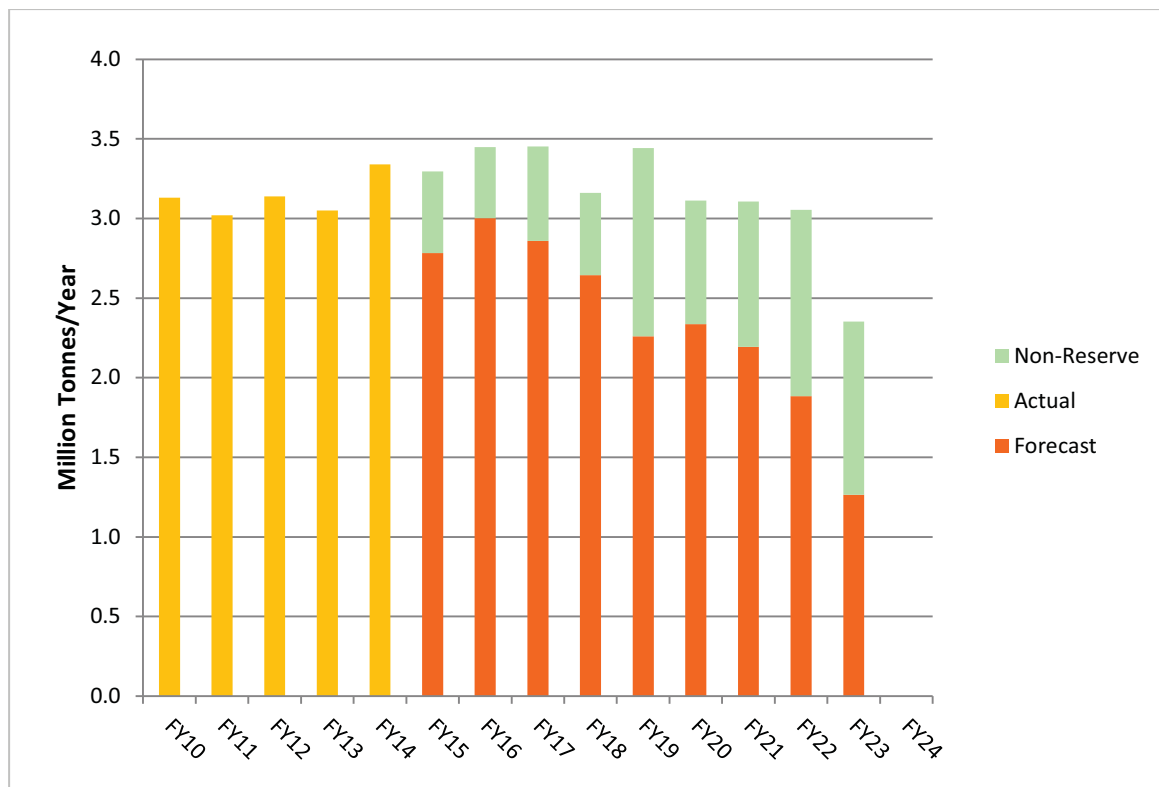

Source: Cannington Asset

Only production forecasts reflected in Table 4.10 have been included in the financial model. Forecast production has been based on detailed design and scheduling. Sustaining production rates will become increasingly difficult as the Ore Reserve is depleted. The average stope size materially decreases going forward as larger more productive stopes are mined requiring an increasingly greater number of stopes to be mined each year. The current mine schedule includes some decrease towards the end-of-mine life but with no residual production tail (stopes scheduled beyond FY23 have been excluded from the plan).

Table 4.10: Cannington Operations Mine production forecast excluding Inferred Resource

Year	Ore Tonnes (dry Mt)	Silver (g/t)	Lead (%)	Zinc (%)
FY 2015 H2	1.6	270	6.7	3.3
FY 2016	3.0	246	6.4	3.8
FY 2017	2.9	248	6.4	4.1
FY 2018	2.6	227	6.5	4.3
FY 2019	2.3	238	6.5	4.5
FY 2020	2.3	242	6.2	4.2
FY 2021	2.2	235	6.2	4.1
FY 2022	1.9	202	5.8	4.1
FY 2023	1.1	208	5.9	3.3
Total	19.9	237	6.3	4.0

Source: Xstract estimate

4.9 Processing

Mineral processing at Cannington Operations commenced in 1997 and has continued to the present. Processing can be described as conventional and the schematic process flowsheet is presented in Figure 4.12.

In summary, the ore treatment process at Cannington Operations uses primary underground and surface crushing. Primary grinding and a preliminary talc pre-flotation step follow this. The third step is differential froth flotation to recover lead and zinc concentrates, which are thickened with the pulp and then leached to remove excess fluorine, after which the concentrates are filtered to be shipped to market through the Townsville port.

4.9.1 Processing method

The ore processing methods used at Cannington Operations are based on froth flotation of the valuable sulphide minerals such as galena (lead, PbS), sphalerite (zinc, (Zn,Fe)S) and freibergite (silver, (Ag,Cu,Fe)₁₂(Sb,As)₄S₁₃). Some of the freibergite is present as a solid solution within the galena.

Ore is crushed in an underground double-toggle jaw crushing facility with the crushed ore hoisted to surface and trucked to an open, conical stockpile. In addition, some underground ore is trammed to surface using LHD units, where it is crushed and then placed on the same stockpile. The crushed ore is moved to the grinding feed stockpile using a front-end loader ("FEL"). The grinding circuit comprises a single 5.8 MW autogenous grinding ("AG") mill at 8.53 m diameter and 3.96m effective grinding length. The AG mill operates in closed circuit with a pebble crushing circuit and primary hydrocyclones.

The hydrocyclone overflow product at a particle size distribution of 80 per cent passing around 110 microns ($P_{80} = 110\mu\text{m}$) is treated in two vertical ball mills ("Vertimills") operating in closed circuit with a second bank of hydrocyclones. The overflow from this circuit is treated in a talc pre-flotation step to remove talc and a significant amount of fluorine. The concentrate from this pre-float step is disposed as a final tailing product. The flotation tailings is fed to another stage of hydrocycloning that allows the fines overflow to

be treated in a bank of rougher flotation cells, while the underflow is treated in another bank of flotation cells in what is termed a "split" flotation circuit.

The fines portion is floated firstly in a rougher bank with rougher tailings joining the coarse stream feed. The fines rougher concentrate is cleaned with lead ("Pb") concentrate sent directly to the Pb concentrate thickener. Cleaner tailings are recycled to the rougher circuit. The hydrocyclone coarse underflow along with the fines rougher tailings is treated in a coarse rougher flotation stage.

This rougher concentrate is sent to regrind mill before being treated in a Pb cleaning flotation bank. The cleaner Pb concentrate is delivered to the Pb concentrate thickener while the cleaner tails are recycled to the Pb rougher circuit. The Pb rougher tailings are sent to the zinc ("Zn") flotation circuit.

The Zn rougher concentrate is reground in a Vertimill prior to being floated in a cleaner bank of cells with cleaner concentrate sent to the Zn thickener. The tailings from cleaners and from roughers are treated in a scavenger bank of flotation cells with scavenger concentrate recycled to the rougher flotation bank with scavenger tailings sent to a tailings thickener as the final tailings product.

The thickened Pb concentrates are pumped to an agitated storage tank where it is leached using aluminium sulphate to reduce the fluorine ("F") content to a level acceptable to smelters. Once leached the Pb concentrate is filtered using a horizontal belt filter. The filtrate from the filter is disposed in a separate fluorine storage pond adjacent to the TSF. The resultant filter cake at about 7.5 per cent moisture is shipped to Townsville port and then on-shipped to the market smelters. The same process is applied to the Zn concentrates and the final filter cake ready for market runs about 9.5 per cent moisture.

The tailings thickener underflow is pumped to a past-fill station where much of the water is extracted and the dense solids are mixed with cement powder and then pumped to underground sites as backfill for mined out voids. The tailings not used as backfill is pumped to the TSF.

The tailings thickener overflow is recycled to the plant, while the Pb concentrate thickener overflow is recycled to the Pb flotation circuit and the Zn thickener overflow is recycled to the Zn flotation circuit.

The Ore Treatment Plant commenced operation at a rated throughput of 1.5 Mtpa. Over the years, the throughput capacity has increased to 3.2 Mtpa and is expected to increase to 3.4 Mtpa. The improved throughputs arose from plant expansions including installation of pebble crushing and increased power station capacity. Plant increases related to a new zinc cleaning circuit and an expansion to the lead fines flotation circuit. The plant was designed to grind to an eighty per cent passing 70 micron (" $P_{80}=70\mu\text{m}$ ") particle size distribution but has operated at higher sizes up to $P_{80}=120\mu\text{m}$ as indicated in Figure 4.12.

Unit throughputs have evolved by increasing the particle size distribution from the design of $P_{80}=70\mu\text{m}$ to $P_{80}=100\mu\text{m}$ and even more. However, over the past five years unit throughput has averaged about 413 tph and the next four years are forecast to treat 435tph, an increase of 5 per cent. Better pebble crushing has been suggested to assist this increase in unit throughput.

Part of the proposed increase in throughput capacity is expected to come from better maintenance availability and, hence, better overall utilisation. In addition, it is forecast that a better unit throughput through the AG mill will evolve.

Figure 4.12: Cannington Operations ore treatment process flowsheet

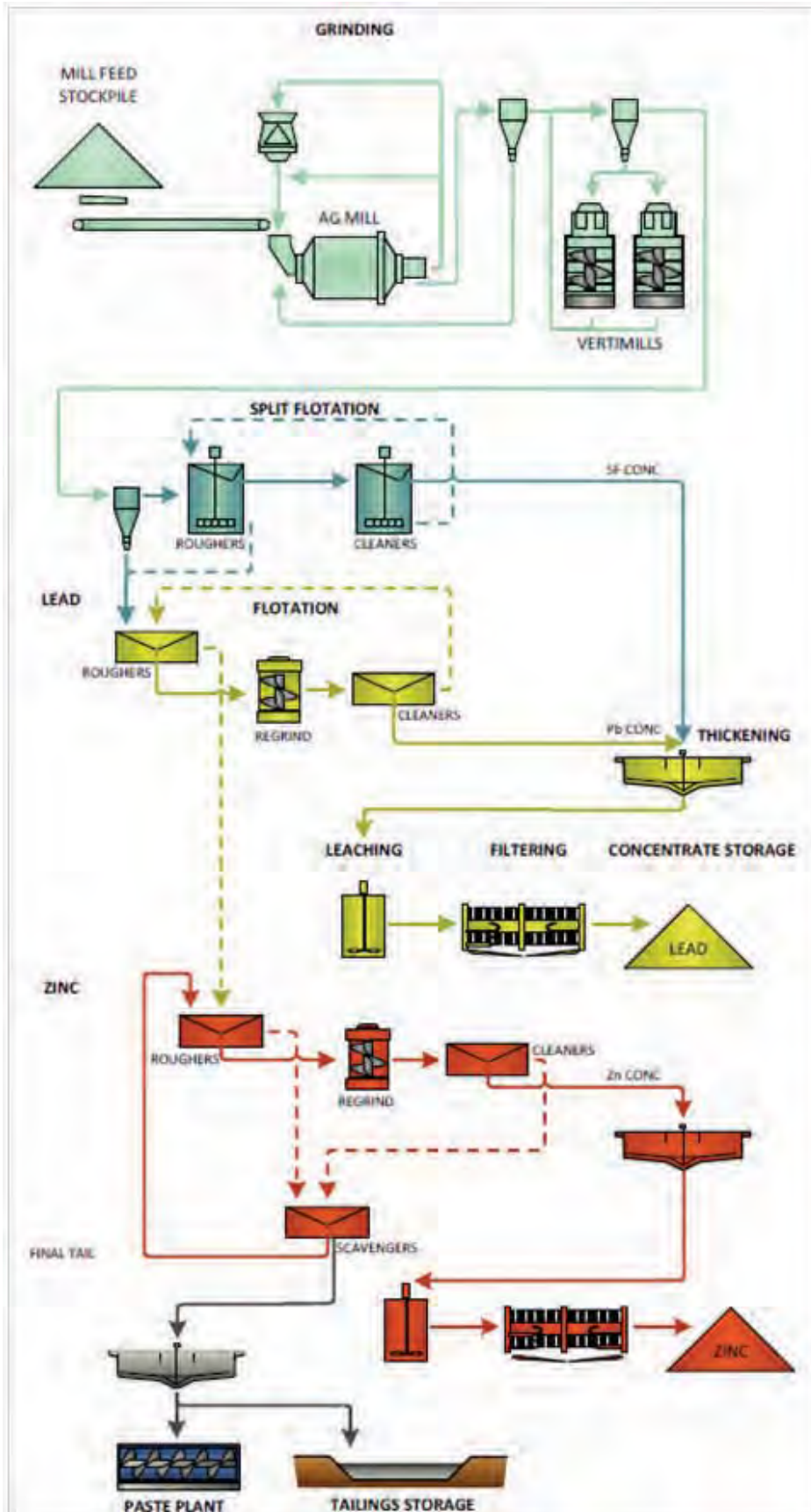

Source: Cannington Asset

Xstract concurs with both improvements and expects that the 3.4 Mtpa throughput rate is achievable. However, the maintenance practices that allowed total utilisation of 90.8 per cent in 2012 will have to be re-instituted in order to return to that level as forecast (90.7 per cent) improve above the 88.6 per cent average recorded for the past two years. The first quarter of FY15 shows an improvement to 89.9 per cent, which is encouraging.

The Cannington Operations Ore Treatment Plant has been operating since 1997 and has performed consistently over that period. Metallurgical performance has been generally as budgeted and with technical improvements the metallurgical performance has been maintained despite lowering feed grades. There is no reason to expect this performance to change over the LOA forecast of eight years of continuing operation to 2023. There are a few anomalies noted below but they remain minor and can be engineered successfully.

4.9.2 Testwork

As the Cannington Operations are mature, specific testwork programmes relate to on-site continuous improvement. Metallurgical testwork is undertaken by the site metallurgical staff and at times, using external third party testing laboratories.

Some testwork was conducted by JK Tech in Brisbane assessing the possible inclusion of flash flotation treating the autogenous mill hydrocyclone underflow. This testwork indicates that there were some “possible” benefits but nothing spectacular. There was an energy saving due mostly because of the lowered amount of material to be ground. Xstract understands that this proposal is unlikely to proceed.

Pre-flotation has been key to keeping the fluorine levels down to acceptable limits by the smelters. The pre-flotation step essentially removes talc material, which carries significant fluorine values but low Ag, Pb and Zn values. Figure 4.13 illustrates the pre-float flowsheet.

Figure 4.13: Cannington Operations Ore Treatment Talc Pre-Float Flowsheet

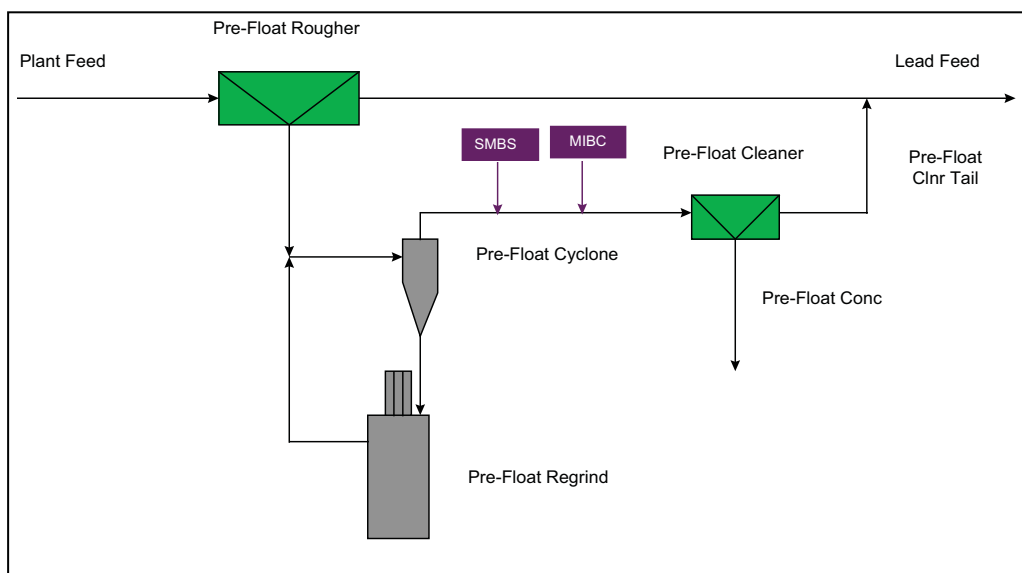

Source: Cannington Asset

Over the years, many programmes were conducted aimed at improving the pre-float performance including reverse flotation and concentrate leaching. To-date, no major changes have been made to the initial pre-float circuit.

A testwork programme was undertaken using hrltesting Laboratories in Brisbane investigating the possibility of introducing heavy medium separation on the crushed feed to the plant with the intent to increase grade to the plant by rejecting non-valuable rock. There was limited success with the testwork but, again, nothing to warrant any action.

Cannington Asset has studied the concept of expanding the paste backfill plant extensively. As stated in the internal report written in June 2014 by Cannington Asset personnel, the present paste plant is the main bottleneck to any sustained increase in throughput. A number of equipment changes/improvements have been proposed with the biggest single item being a change to two new disc filters. The costs for all of the modifications have been estimated at AUD8.7 M. The project was completed over an 8-day period in October 2014 and preliminary reports suggest the upgrade is performing as expected.

Cannington Asset has commenced a study to determine ways and means of increasing pebble-crushing capacity. Presently the pebble crusher treats only about 97 tph while the objective is 150 tph. In addition, the pebble-crushing concept is to keep crusher bypass to less than 15 per cent of feed while experience to-date has been 45 per cent by-pass due to crusher maintenance requirements. The crusher is fed directly from the feed conveyor, which results in unregulated feed and inordinate localised wear. The modification concept is to allow for a more controlled feed using a feed box and changing the crushing eccentric such that the crusher has reduced capacity and can be more easily choke fed. It is planned to undertake a four-month trial with temporary installations and then assess the economic benefits. The desire is to attain a 3.5 per cent increase in mill feed with this pebble crusher upgrade, which would be incorporated permanently in Q1 FY16. The cost of the trial is about AUD100,000. No statement regarding the permanent modifications was provided.

4.9.3 Historical and forecast operating statistics

Historical

Table 4.11 summarises the process plant key production items for the past five years.

Table 4.11: Process plant historical performance – FY2010 to Q1 2015

Operating Year (End June)		2010	2011	2012	2013	2014	2015
Parameter	Units						Q1
Mill Feed	Mt dry	3.141	3.090	3.337	3.145	3.203	0.819
Operating Time	hours	n/a	n/a	7,975	7,757	7,758	1,986
Total Utilisation	%	n/a	n/a	90.8	88.6	88.6	89.9
Throughput	tph	n/a	n/a	418	405	413	412
Grind Size	P ₈₀ = µm	n/a	n/a	123	98	120	n/a
Head Grade Pb	%	9.47	9.50	8.63	7.94	6.96	7.10
Zn	%	3.36	3.31	2.84	2.98	2.96	3.80
Ag	ppm	451	430	384	363	289	301
Concentrates							
Pb Concentrate	kt	367.4	365.2	361.4	323.8	286.9	76.1
Pb Grade	%	70.3	70.2	69.6	69.4	68.4	67.7
Contained Pb	kt	258.4	256.2	251.7	224.6	196.3	51.5
Pb Recovery	%	89.5	90.0	90.2	89.9	88.1	88.6
Ag grade	g/t	3,270	3,113	3,051	3,086	2,816	2,794

Operating Year (End June)		2010	2011	2012	2013	2014	2015
Parameter	Units						Q1
Contained Ag	Moz	38.63	36.55	35.45	36.45	37.45	6.84
Ag Recovery	%	87.5	88.3	88.7	87.4	87.3	86.4
Zn Grade	%	4.4	4.3	4.1	4.5	3.7	4.0
Zn Recovery	%	15.8	15.8	16.0	15.6	11.2	n/a
Zn Concentrate	kt	151.5	148.3	136.1	138.5	146.4	49.8
Zn Grade	%	49.4	49.0	48.2	48.6	47.5	48.0
Contained Zn	kt	74.83	72.60	65.57	67.36	69.61	23.9
Zn Recovery	%	72.9	73.4	71.6	71.8	73.4	76.4
Ag grade	g/t	276	257	267	268	235	222
Contained Ag	Moz	1.34	1.22	1.17	1.19	1.11	0.36
Ag Recovery	%	3.0	3.0	2.9	3.2	3.7	4.5
Pb Grade	%	3.8	3.9	3.6	3.6	3.8	3.5
Pb Recovery	%	2.0	2.0	1.8	2.0	2.5	n/a

Source: Cannington Asset

While throughput rates remain reasonably constant year-on-year, head grades are steadily declining as shown in Figure 4.14. This is especially true with lead head grades, which have reduced about 27 per cent since 2011 while zinc head grades have fallen about 11 per cent and Ag has dropped almost 33 per cent since 2011. The 2015 year-to-date (“YTD”) figures for September 2014 indicate that head grades have recovered slightly and have exceeded the budget for the same period. Nevertheless, looking at the forecast grades for the LOA, head grades are expected to decrease steadily.

Figure 4.14: Cannington Operations historical head grades

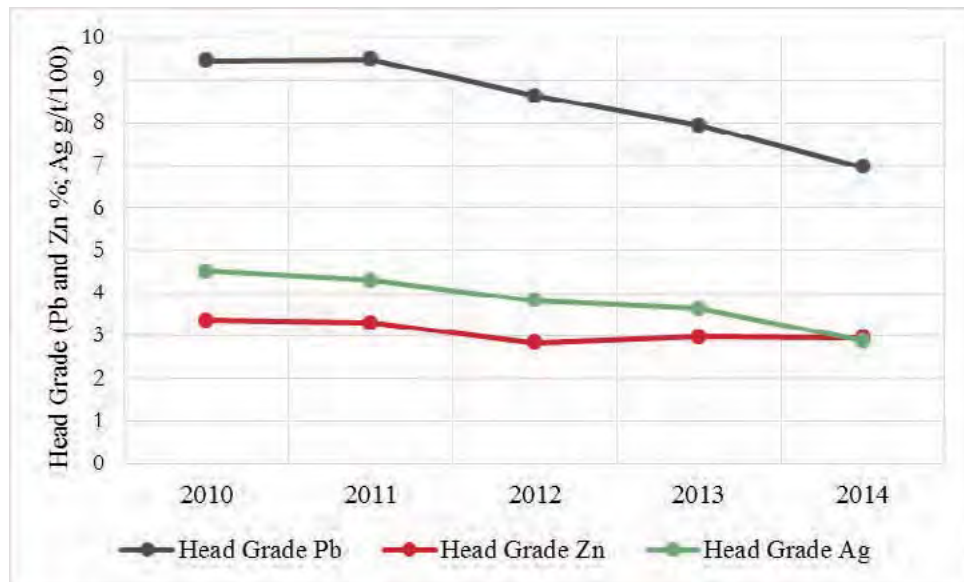

Source: Xstract

Cannington Asset’s LOA forecast continues the trend of reducing head grades as shown in Figure 4.15.

Figure 4.15: Cannington Operations Head Grades – 2010 to 2015 (Historical) and 2016 to 2023 (Forecast)

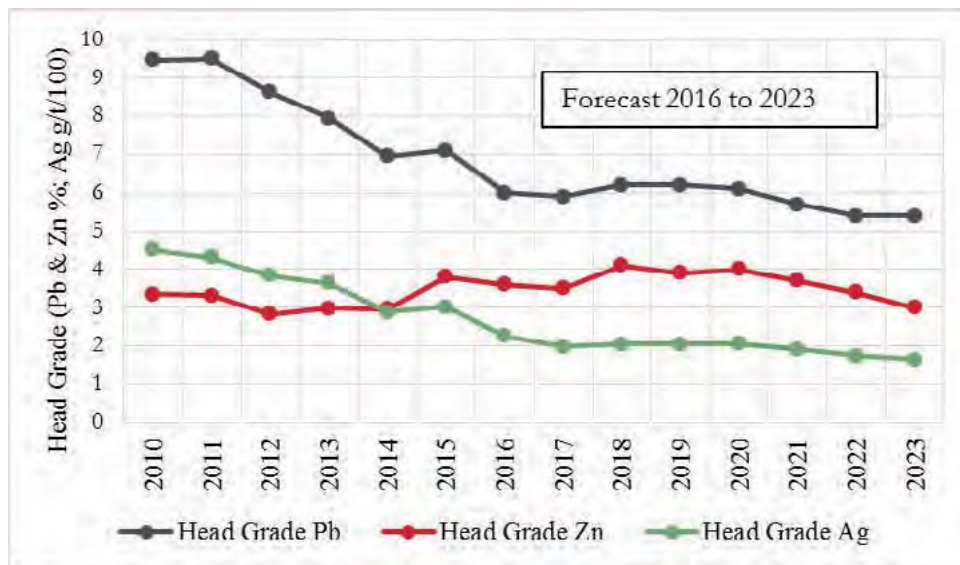

Source: Xstract

Over this five-year historical period, the lead concentrate grade has dropped slightly (70.3 per cent to 68.4 per cent lead) and the silver grade in the lead concentrate has steadily dropped from 3,370 g/t to 2,816 g/t. Recovery of lead has dropped mostly from 2012 at 90.2 per cent to 88.1 per cent in 2014. Silver recovery has remained relatively constant at about 87.5 per cent.

The zinc concentrate for the five years has also reduced steadily in zinc grade from 49.4 per cent zinc to 47.5 per cent zinc, although zinc recovery has remained relatively constant and could be considered to be increasing over the past three years. Silver grades were steady until 2014 with a drop from 268 g/t to 235 g/t.

The latest monthly report for FY15 states the YTD (end-September 2014) lead concentrate grade continues to decrease for both lead and silver. Recoveries for lead are as budgeted and are slightly better than FY14. Recovery of silver continues to decrease and for the September quarter, silver recovery was lower than budget.

Forecast

Cannington Asset has presented a forecast of production physicals for the period FY16 to the end of LOA in 2023. Table 4.12 summarises the important key performance indicators ("KPIs") for this forecast period.

The forecast is generally acceptable based on the assumption that the ore can be delivered as budgeted. A few minor anomalies are noted:

1. Overall plant utilisation at 90.7 per cent is 2.4 per cent higher than has been experienced for the past two years and 0.9 per cent higher than in Q1 FY15.
2. Mill feed for the next five years peaks at 3.45 Mtpa which is 8.5 per cent greater than the average experienced over the past five years, however is only 4.5 per cent higher for the next five years when compared to the previous five year period.
3. The lead concentrate grade forecast at 70 per cent lead has not been experienced at Cannington Operations since 2011.

4. Similarly, the zinc concentrate grade at 50 per cent zinc has not been experienced over the past five years.

These anomalies are not excessive and reflect what can be termed a “push” budget. Nevertheless, there has not been any discussion in the documents supporting these optimistic forecasts.

Table 4.12: Process plant forecast performance – FYs 2016 to 2023

Operating Year (End June)		2016	2017	2018	2019	2020	2021	2022	2023	TOTAL
Parameter	Units									
Mill Feed	Mt dry	3.458	3.454	3.160	3.443	3.112	3.155	3.102	2.401	25.285
Operating Time	hours	7,969	7,946	7,946	7,946	7,969	7,946	7,946	7,946	63,613
Total Utilisation	%	90.7	90.7	90.7	90.7	90.7	90.7	90.7	90.7	90.7
Throughput	tph	434	435	398	433	391	397	390	302	397
Head Grade Pb	%	6.0	5.9	6.2	6.2	6.1	5.7	5.4	5.4	5.9
Zn	%	3.6	3.5	4.1	3.9	4.0	3.7	3.4	3.0	3.7
Ag	ppm	227	198	205	205	206	191	174	165	198
Concentrates										
Pb Concentrate	kt	260.8	256.0	246.7	270.8	239.5	226.7	209.4	164.6	1,874.6
Pb Grade	%	70	70	70	70	70	70	70	70	70
Contained Pb	kt	182.6	179.2	172.7	189.6	167.7	158.7	146.6	115.3	1,312.2
Pb Recovery	%	88.3	88.1	88.8	88.6	88.6	88.1	87.7	88.9	88.4
Ag grade	g/t	2,620	2,333	2,308	2,285	2,356	2,331	2,250	2,136	2,339
Contained Ag	Moz	22.0	19.2	18.3	19.9	18.1	16.9	15.2	11.3	141.0
Ag Recovery	%	87.2	87.3	88.0	87.6	88.0	87.5	87.3	88.6	87.6
Zn Concentrate	kt	185.9	181.3	201.9	201.7	191.9	177.2	160.9	112.2	1,412.8
Zn Grade	%	50	50	50	50	50	50	50	50	50
Contained Zn	kt	92.9	90.6	100.9	100.8	95.9	88.6	80.4	56.1	706.4
Zn Recovery	%	75.6	75.4	77.1	76.1	77.0	76.4	76.2	76.9	76.3
Ag grade	g/t	131	117	99	109	104	106	104	110	110
Contained Ag	Moz	0.78	0.68	0.64	0.70	0.64	0.60	0.54	0.40	4.99
Ag Recovery	%	3.1	3.1	3.1	3.1	3.1	3.1	3.1	3.1	3.1

Xstract considers that the throughput targets for mill feed and utilisation should be achievable provided the operating and maintenance staff continue to focus on continuous improvement practices.

However, Xstract does not consider that the optimistic metallurgical performance projections for Pb and Zn concentrates will eventuate because of the continuing trend of

decreasing head grades. Xstract suggests that with the decreasing head grades the lead concentrate grades will unlikely stay at 70 per cent Pb and the Ag grades may drop more than forecast. In addition, Xstract expects lead recoveries will drop rather than increase as forecast. Similarly, silver recoveries should drop as the head grade decreases. Cannington Asset should undertake bench-scale testwork to support metallurgical performance forecasts to 2023.

Going forward, Xstract expects concentrate grades are likely to be no better than those achieved in 2014. As such, Xstract has reduced the Pb and Zn concentrates as outlined in Table 8.2 of Section 8.3.2.

4.9.4 Infrastructure

The processing plant infrastructure incorporates reagent storage, mixing and handling, water supply, power supply, sewerage treatment and tailings disposal.

Reagents

The reagent regime for the Cannington Operations is relatively straightforward. Table 4.13 summarises the reagents used.

Table 4.13: Process plant reagents

Reagent	Unit	Use	Process Use
Lime	tpa	1,000	Neutralise leach plant effluent
Alumina	tpa	1,500	Source of aluminium to react with sulphuric acid to produce aluminium sulphate
Copper Oxide	tpa	50	Used to make copper sulphate
Copper Sulphate	tpa	500	Activator in zinc flotation circuit
Zinc Oxide	tpa	200	Used to make zinc sulphate
Zinc Sulphate	tpa	400	Depressant for zinc in the lead circuit
Sodium Metabisulphite	tpa	500	Depressant for lead, zinc and iron sulphides in silver flotation circuit
Sodium Ethyl Xanthate	tpa	500	Flotation reagent; collector
Sodium Dithiophosphine	tpa	50	Flotation reagent; collector
Methyl Isobutyl Carbinol	tpa	50	Flotation reagent; frothing agent
Sulphuric Acid	tpa	6,000	pH modifier in concentrate leach circuits and lead flotation and to allow manufacture of other reagents.
Aluminium Sulphate	tpa	30,000	Used to leach fluorine from concentrates
Anti-Scalant	tpa	50	Water additive
Flocculants	tpa	50	Enhance dewatering of slurries
Cement	tpa	70,000	Paste fill production

Source: Cannington Asset

Sulphate reagents such as copper sulphate, zinc sulphate and aluminium sulphate are manufactured on-site via mixing of the metal oxide with sulphuric acid and water. The mixed sulphate reagents are stored in 100 m³ vessels and pumped to the required destinations.

Dry powder reagents (xanthates and sodium metabisulphite) are stored undercover and mixed in a purpose built facility with the mixed reagents stored in a 100 m³ vessels and pumped to the required destinations.

The liquid reagents, dithiophosphine and methyl isobutyl carbinol ("MIBC"), are imported to site and stored in 50 m³ vessels within bunded areas.

Sulphuric acid is imported in bulk and stored in a 1,600 m³ storage vessel. This acid is used for many functions including pH adjustment in the flotation circuits as well as manufacture of the copper, zinc and aluminium sulphates.

Quicklime is stored in a 200 t silo and mixed via a slaker with the slurry stored in a 50 m³ agitated storage tank. Cement for backfill is imported by truck and stored undercover.

Flocculants are stored in silos and mixed via "jet wet" systems. Apart from bulk silo storages for cement, lime and flocculent, all dry reagents are stored under cover.

All liquid reagent storage facilities are bunded with dedicated spillage pumps. In addition, the entire plant processing area is bunded with drainage from this area reporting via culverts to the catch dams.

Other reagents are used from time to time on a trial basis for plant/business optimisation. These are stored in bunded areas within the plant using purpose built containers.

Concentrate handling and shipment

The two flotation concentrates have been thickened and filtered and stockpiled in separate storage compartments. In order to access the market (smelter), it is necessary first to ship from the Cannington Operations by truck to a rail-head and thence to the port of Townsville. It is stored until a sufficient amount is collected to fill the required ship holds organised for sea freight to the smelter sites.

At the mine site, the concentrates are loaded into standard road train units with side body tippers that are covered. These road trains truck the concentrates about 180 km north of the mine site by way of the Landsborough Highway to the Yurbi storage shed facility for rail loading. From time to time, road train haulage direct to Townsville or even Mount Isa occurs. The concentrates are loaded into commercial covered rail wagons and transported by Aurizon Holdings Limited ("Aurizon") some 800 km to Townsville. In Townsville, the wagons are dumped into specific storage areas and these concentrates are shipped whenever the ship arrives at the port.

4.9.5 Tailings and waste management

The Cannington Operations has incorporated a paste back-fill plant to allow tailings material to be dewatered using disc filters. The higher density slurry is then mixed with cement and sent underground so that mined-out stopes can be filled allowing more stable underground conditions. Paste production has been less than desired and an expansion/improvement programme was instituted and is now in operation.

The tailings product from the Ore Treatment Plant after removal of the backfill is pumped to the TSF. The TSF is a conventional "turkey's nest" constructed dam above ground. The TSF currently being used is a 3-cell configuration includes a decant pond. In addition, there is an evaporation pond used to evaporate the leach liquor from the aluminium, leaching of the concentrates to remove fluorine. The three structures occupy an area of about 172 ha. At the end of LOM, it is expected that the TSFs and various ponds will occupy a total area of about 272 ha. The TSF itself has been constructed in compliance with all of the statutory requirements. Groundwater bores have been established around the outer perimeter of the

TSF to monitor any seepage. Emergency spillways have been established to avoid over-topping of the TSF walls.

A third cell has been constructed nearby with an area of 52 ha and a capacity of three years production. The existing Cell 2 can be increased in capacity by lifting the walls in what is termed the fifth lift. Cell 3 is in place and was completed in 2013. The general arrangement of the TSF installation for LOM is shown in Figure 4.16.

The operating procedure is to pump the tailings from the plant in a ring main pipeline so that the tailings can be spigotted around the internal perimeter of the impoundment walls. This allows a minimum amount of water to be contained as well as ensuring maximum deposition density. In addition, other waste waters are deposited into the TSF. Water is decanted from the TSF into the decant pond from where it is pumped back to the processing plant as process water.

Figure 4.16: Cannington Operations LOM Tailings Storage Facilities Layout

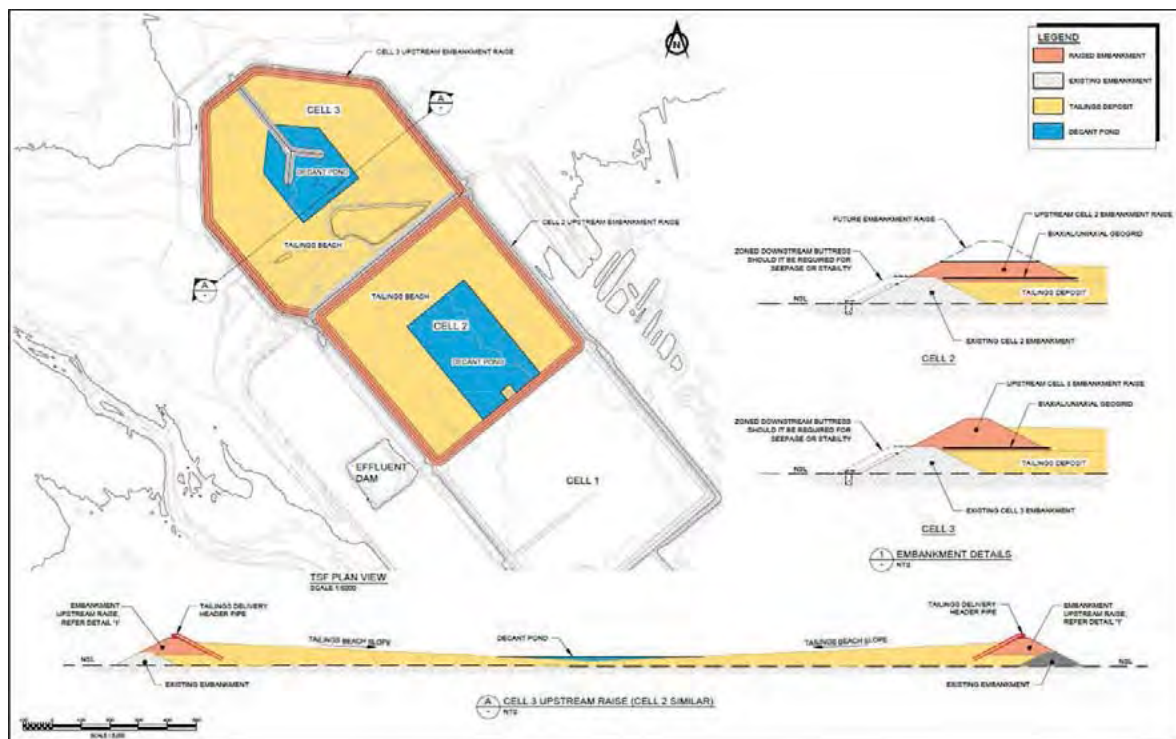

Source: BHP Billiton

4.10 Equipment and manning

Cannington Asset owns the majority of underground production vehicles, in addition to all trucks moving ore to surface via the decline system. The current mine fleet is summarised in Table 4.14.

Table 4.14: Cannington Operations Underground mining fleet

Manufacturer	Type	Units	Unit No.	Description	Notes
Cannington Asset					
Tamrock	Axera D07	3	DR107, DR108, DR109	Jumbo	
Atlas Copco	Simba M2C/LC6	3	DR308, DR315, DR317	Production drill	
CAT	R1700G	1	LD116	Development Loader	5.7 m ³ bucket
CAT	R2900G	5	LD120, LD121, LD122, LD123, LD124	Production Loader	Tele-remote capable, 8.3 m ³ bucket
CAT	R3000G	2	LD203, LD204	Production/Crusher Loader	8.9 m ³ bucket
CAT	AD55B	3	TR119, TR123, TR124	55t Haulage Truck	
CAT	AD60	4	TR125, TR126, TR127, TR128	60t Haulage Truck	
Normet	Multimec	1	TK104	Services	
Normet	Charmec	1	TK303	Development charging	
CAT	IT62H	3	LD224, LD225, LD228	IT - Services	
CAT	IT930H	1	LD227	Development charging	
Various	Light Vehicles	34			
Contractor Machines					
Normet	Spraymec	2	144, 173	Shotcreting	Redpath
Normet	Agi Truck	2	AG2106, AG2124	Agitator Truck	Redpath
Sandvik	DS420	1	DR338	Cabotler	Redpath
CAT	140H	2	GRH001, GRH002	Grader	Redpath
Volvo	IT - L120C	1	146	Projects/Services	Redpath
Volvo	IT - 120D	1	148	Projects/Services	Redpath
Volvo	IT - 120F	1	114	Projects/Services	Redpath
MAN	LE18.280	1	-	Production charging truck	Orica
Various	Light Vehicles	10			

Source: Cannington Asset

Redpath Australia Pty Ltd ("Redpath") supplies the fleet for moving the ore from the shaft to the ROM pad. Fleet management is achieved using a mature tracking system that allows engineering staff to track and analyse fleet movement and individual unit statistics. A major service and fleet replacement schedule is in place and is continually monitored to ensure replacement fleet is ordered with sufficient lead-time to replace ageing units.

In addition, Redpath's trucking fleet moves an average of 41,500 tpm (based on previous 27 months) of lead and zinc concentrate from the mine site to the Yurbi train loading facility. Negotiations to extend Aurizon's rail contract have been completed with a new rail haulage agreement entered into on 23 January 2014.

Cannington Operation's workforce operates an extended shift commute roster predominantly on a fly-in-fly-out basis from Townsville and Brisbane. The mine currently employs approximately 1,100 people comprising permanent BHP Billiton staff and strategic long-term contractors/partners split approximately 60:40 as permanent staff. Over the next five years, the operation expects a small reduction (approximately 6 per cent) in workforce numbers, split 4 per cent and 9 per cent between permanent staff and contractors respectively (Table 4.15).

Table 4.15: Cannington Operations workforce numbers – actual and forecast

Labour	Act FY11	Act FY12	Act FY13	For FY14	2YB/5YP FY15	2YB/ 5YP FY16	5YP FY17	5YP FY18	5YP FY19	5YP Re- duction
Permanent	631	679	674	652	647	642	633	626	627	4%
Contractors	447	641	511	454	452	435	472	451	412	9%
Total	1,078	1,320	1,185	1,106	1,099	1,077	1,105	1,077	1,039	6%
% Contractors	41%	49%	43%	41%	41%	40%	43%	42%	40%	

Source: Cannington Asset

Act – actual, 2YB – two year budget, 5YP – five year projected

4.11 Management and Industrial Relations

Throughout this assignment, Xstract's representatives have been in regular contact and held numerous discussions with all levels of Cannington Asset's management, operational and technical teams. Based on this contact, Xstract is satisfied that Cannington Asset has established a capable management team at the mine and at within the Townsville Corporate office. The mine management and operations teams understand the key drivers and risks at the mine and have developed credible systems and operational plans to manage the mine effectively. Cannington Asset has established a technical services group to coordinate mine planning involving staff from all relevant departments.

The mine has a history of co-operative industrial relations with no evidence of lost time due to disputes. All award employees are covered by in-term industrial instruments.

4.12 Health and Safety

Cannington Asset has a rolling average Total Recordable Incident Frequency rate ("TRIF") of 9.70 for the 12-month period up to October 2014. The mine monitors energy exchange incidences (vehicles and mobile equipment, ground control, isolation and permit work, lifting operations, explosives and blasting, hazardous material and working at height) to ensure safer working practices within its workforce. Direct health and safety responsibility resides with line management and, as is essential in the effectiveness of any system, relies on workforce involvement.

The yearly TRIF target is based on an improvement on the previous FY performance, suggesting that the objective is to continually reduce the TRIF rate. No fatalities have been registered at the Cannington Operations since 2008.

During Xstract's underground site visit, safety was observed to be at the forefront of the operation including a Proximity Detection system ("PDS"), which incorporates an exclusion zone around underground heavy vehicles.

4.13 Infrastructure

Power

A third party, Energy Developments Ltd ("EDL") owns and operates the Cannington Operations power station, through their Remote Energy division. This station comprises a suite of 30 generators sourced either by diesel or natural gas. Table 4.16 reflects the breakdown in size and power source for the generators used on the mine. Total rated capacity is 40 MW.

The natural gas is reticulated via pipeline from the Ballera gas field in southwest Queensland. The power plant also operates a 5.5 MW thermal steam plant. Each generating engine is individually housed and noise emissions are controlled at 75 dB(A) measured 1 m from the enclosure.

Xstract considers the installed capacity to be sufficient for on-going operations.

BHPB Minerals has a contract in place with EDL for the supply of electricity until 2018.

Table 4.16: Power breakdown by generator type

Generator	Units	Source	Electric kilowatts at		MW available
			Power Factor 0.8	Power Factor 0.7	
3516B	4	Diesel	1,400		5.60
G3516LE	18	Natural gas	1,030		18.54
G3520C	8	Natural gas		1,915	15.32
Total	30				39.46

Source: BHPB Minerals EDL Contract

Water

BHPB Minerals has a water licence and water permit in place (Water licence 93004J and Water permit 60952) which allows for the abstraction of 2,210 MI from the Great Artesian Basin ("GAB") on an annual basis. The borefield is situated some 20 km east of the mine, with nine boreholes currently servicing the mine's requirements. The total volume of water permitted to be abstracted under the current licence is 45,715 MI. The current licence is set to expire in 2022 with current LoA mine plans indicating that this may fall short by a year. The licence does, however, make provision for an extension which, based on verbal discussions, should be extended, provided the Cannington operation continues to show appropriate water management principles.

4.14 Transportation

Cannington Asset's product transport system consists of two parts. The first is a trucking leg of approximately 180 km from the mine site to Yurbi rail load-out facility located east

of Cloncurry, with the second comprising a rail leg from Yurbi to BHP Billiton's dedicated concentrate storage and ship loading facility at Townsville Port.

Redpath manages the initial trucking section and are contracted to move all concentrates from the mine to Yurbi. The concentrate is then loaded onto trains, operated by Aurizon, for transport to the port at Townsville wherein the concentrate is loaded into the concentrate storage facility, prior to being loaded onto ships for export.

4.15 Explosives management

Cannington Asset has a Goods and Service contract in place for the supply of explosives with Orica Limited ("Orica"). Orica's facilities on surface consist of separate bunkers and storage areas for explosives and ancillaries. The facility is located approximately 1.4 km to the north of the mine and 1.7 km south-southeast of the Cannington Operations accommodation village.

The current Orica contract is in place until 2019.

4.16 Marketing

The marketing function of Cannington Asset's production for export is conducted out of the central BHP Billiton marketing office in Singapore. This office negotiates contracts for the sale of concentrates to a range of customers in Korea, Japan, Canada and Europe. Domestic sales are coordinated by Cannington Asset directly.

Concentrates are sold largely on medium to long-term contracts with a small portion sold on the spot market to allow for flexibility in production variability. Term contracts secure the off-take tonnes and metal pricing, normally based on the quoted London Metal Exchange prices and London Bullion Market (for silver price). Treatment and refining charges are negotiated annually for approximately 90 per cent of customers. Two contracts have a provision for penalty elements in concentrates which include fluorine, iron and magnesium oxide. Ranges for the content of these elements in concentrates are set out in these contracts and penalties are incurred if concentrations of these elements exceed these ranges. Blending can take place by the mine to ensure concentrations are within contractual ranges.

4.16.1 Domestic market

Cannington Asset has two domestic customers, namely:

- A zinc refinery in Townsville, Queensland takes between 90,000 and 120,000 dmt of zinc concentrate per year.
- A lead smelter in Port Pirie, South Australia takes some 70,000 dmt per year of lead concentrate.

Logistics for the delivery to domestic customers is arranged from the Cannington Operations office.

4.16.2 Export market

Product is sold to a range of international customers. The high silver content in the lead concentrate is highly attractive to the market.

Lead and zinc concentrates bound for the export market are trucked to Yurbi and then railed to Cannington Asset's export terminal in Townsville where product is loaded onto dry bulk ships.

Logistics of the product to the Townsville port loading facility is arranged from Cannington Asset's site office. BHP Billiton's Singapore office arranges shipment to offshore destinations.

4.17 Environment and social

4.17.1 Environmental status

The Cannington Operations are subject to Commonwealth and State Government environmental laws, regulations, and policies. It has received all appropriate environmental approvals to date.

BHP Billiton expects that its subsidiaries, such as BHPB Minerals, will "demonstrate environmental responsibility by minimising environmental impacts and contributing to enduring benefits to biodiversity, ecosystems and other environmental resources"

In 1994, BHP Minerals submitted an Initial Advice Statement ("IAS") to the Queensland Government identifying potential environmental impacts and mitigation measures for the proposed Cannington Operations. The Environment Minister determined that a Type 2 Environmental Impact Assessment ("EIA") process was acceptable and consequently BHP Minerals developed an Environmental Management Overview Strategy ("EMOS") in support of the Mining Lease application. The application was approved and Environmental Authority ("EA") #190027 was issued as per the *Environmental Protection Act* 1994, prior to mining operations commencing in 1997. The EA establishes limits on emissions to water, land, and air, and from the eventual rehabilitated site. The EA has been amended periodically; the most recent EA (EPML00897513) was issued to take effect 26 June 2014. EA EPPR00932913 (formerly IPCE00573807B11) for the Townsville port facility was issued under the *Sustainable Planning Act* 2009, and this deals with stormwater management and the potential discharge of polluted stormwater into the harbour.

Cannington Operations does not affect Matters of National Environmental Significance ("MNES") listed in the *Environmental Management and Biodiversity Conservation Act* 1999 ("EPBC Act"). A number of EPBC listed migratory birds do occur seasonally on site, however these do not constitute an "ecologically significant proportion" of the national population, and are unlikely to be affected by mining operations. The mine does not, and will not, affect World Heritage Properties, National Heritage places, wetlands of international importance, or Commonwealth marine areas. Consequently, the mine and its proposed extension did not, and do not, trigger referral to the Commonwealth Environment Minister.

The ML area occurs in a hot semi-arid environment. Mitchell grassland (*Astrebla* sp.) and sparse Gidgee woodlands (*Acacia cambagei*) are the predominant vegetation types within the mine area, while Coolabah (*Eucalyptus coolabah*) and River Red Gum (*E. camaldulensis*) dominate the riparian margins. One hundred and sixty one native plant species occur within these communities. All of the vegetation types and constituent species are widespread and common and are not of conservation significance or of concern.

The sparse vegetation supports a diverse assemblage of terrestrial fauna, with 283 species recorded, although the habitats associated with the ML area are well represented in the local area and do not require special attention. A number of species found within the area are of conservation significance, such as the bird Pictorella Mannikin (*Hetermunia pectoralis*) and Troughten's Sheath-tail Bat (*Taphozous troughtoni*), but these are unlikely to be affected by existing mine management and operations. Spinifex habitat adjacent to the Hamilton River supports the highest abundance and diversity of species, while the Mitchell grasslands are generally poor in mammal and reptile abundance and diversity. The River Red Gum woodlands provide abundant nesting sites, and bird diversity is highest in

this area. Populations of all species tend to grow during or immediately after the wet season.

The ephemeral watercourses in the ML area are typical of those in the wider region. They flow briefly during heavy rainfall events, particularly in the wet season, and there are no standing bodies of water. Three fish species, 1 crustacean, and 27 macro-invertebrate taxa were captured in surveys during stream flow. Hamilton River contained a higher number of taxa than Trepell Creek; none of the species is of conservation significance.

The mine is largely underground, and the operational footprint above ground (including the accommodation village, TSF, ROM pad, and processing infrastructure) is kept as small as possible. This has minimised land disturbance and vegetation clearance, and the majority of the post-mine area will be able to be rehabilitated back to the original ecological condition and economic function. The exceptions will be the TSF and the entrance to the mine.

Electricity is generated onsite from natural gas. This releases fewer GHG emissions than electricity sourced from coal-fired power stations. Cannington Asset reports to Government on its total GHG emissions and GHG reduction strategies.

4.17.2 Social status

Cannington Operations is located in a very remote area of Queensland and is 130 km from the nearest major town, Cloncurry. The Statistical Area has a total population of some 4,000 people. The mine is a significant source of employment and economic activity for the region and the State, although the workforce is predominantly FIFO.

BHP Billiton expects that its subsidiaries, such as BHPB Minerals, will work to “understand and minimise adverse social and human rights impacts from our activities, develop strong, mutually beneficial relationships with people, local authorities and social organisations in communities and regions that host our businesses and contribute to their economic and social development”.

The closest homestead is 3 km from the mine site, with eight occupied or unoccupied homesteads occurring within a 20 km radius of the mine site. BHPB Minerals has addressed potential adverse social impact through purchasing adjacent properties (and leasing the grazing rights to the previous landholder), pre-emptive mitigation such as supply of potable water, or compensation agreements.

Social surveys funded by Cannington Asset indicate that the mine is generally well regarded in the area. There appear to be none of the environmental or social issues facing other, high profile, mine sites that would affect the mine’s social licence to operate. This is due largely to its isolation, reliance on underground operations, and non-controversial products. Social licence to operate may be affected if there was a pollution event affecting human or environmental health in the area or along transit routes to the Port of Townsville. Such an event is unlikely, and the risks are mitigated through strict environmental controls, monitoring, and provision for rapid response.

4.17.3 Community relations, plans and programmes

Cannington Asset has recently published its 2014-2015 Community Development Management Plan (“CDMP”). The CDMP identifies that the:

- Social baseline assessment is reviewed every three years
- Stakeholder Engagement Management Plan is reviewed annually
- Perception survey is reviewed every three years
- Impact and Opportunity Assessment is reviewed every three years

- CDMP is reviewed annually
- Effectiveness of CDMP evaluated through analysis of changes in baseline indicators every three years.

Cannington Asset has chosen to focus community development activities on its nearest neighbours in direct contact with its main business activities. Consequently, the focus is on the Shires of McKinlay and Cloncurry, and the City of Townsville in order to achieve greatest impact from community development activities. The investment model focusses on strategic partnerships with community groups, NGOs, and business organisations; project donations through the Cannington Community Development Fund ("CCDF"), and; direct engagement in community activities and organisations.

To date, Cannington Asset has supported community programs to improve socio-economic conditions in the area through the CCDF. The CCDF was established in 2006 and supports non-profit organisations in developing sustainable projects. Priority areas for the program are projects that will provide lasting benefit in the areas of health and safety, education, environment, the arts, and sport and recreation. The CCDF is funded at AUD1 million per annum.

Cannington Asset has sponsorship or community partnership arrangements with a number of organisations, such as the Cloncurry Police and Citizens Youth Club, James Cook University School of Engineering, and the Smith Family. Cannington Asset staff are also involved (often voluntarily) in a range of important community events, such as the McKinlay Races, the Cloncurry Rodeo, and Battle of the Bands at the Cloncurry Show.

Cannington Asset provides information to and consults with the local community through the Cannington Community Engagement Group and the CANdid Newsletter, a bi-monthly newsletter distributed to the local community. The newsletter provides information on issues, incidents, functions and performance at the mine, and upcoming events supported by Cannington Asset. It also produces an annual Health, Safety, Environmental and Community Report allowing community monitoring of performance and the identification of issues and their resolution.

Independent community perception surveys funded by Cannington Asset were undertaken in 2005 (by Globescan), 2008 (by Centre for Social Responsibility in Mining, University of Queensland), 2010 (by Plan C), and 2013 (by Qld Corporate Communications Network). These surveys have found that the Cannington Operations are generally well regarded and that their community efforts are appreciated. Opportunities to improve public perception through increased promotion of the CCDF have been noted and actioned. Community concerns directly related to the mine continue to focus on the effect of FIFO on social cohesion and local communities, and the sharing of water resources. The majority of respondents believe that Cannington Asset is committed to environmental protection.

A dedicated contact phone line is available for community members with enquiries or complaints. Complaints received are recorded in a register and attempts are made to resolve the issue immediately.

The 2014-2015 CDMP identifies that the following are priority focus areas for future investment in community development:

- Social cohesion
- Environment and community health
- Economic diversity
- Education and young people.

Cannington Asset seeks to achieve this through an increased focus on partnerships relative to donations.

Traditional owners

Cannington Asset established the Cannington Aboriginal Liaison Group in 1994 as the main communication vehicle for the surrounding language groups and People. The original approvals for the Cannington Operations predate the *Native Title (Queensland) Act 1993* and there are no Indigenous Land Use Agreements ("ILUA") over the mine licence area. A Native Title claim lodged by the Mitakoodi people was struck out in 2009, while a claim by the Yulluna people over a wide area of traditional lands is still current. Nevertheless, Cultural Heritage Management Plans ("CHMP") have been developed in consultation with traditional owners from the Yulluna and Mitakoodi people. These plans are consistent with the *Aboriginal Cultural Heritage Act 2003* and commit Cannington Asset:

- To avoid Harm to Aboriginal Cultural heritage as far as is practicable;
- To the extent that Harm cannot reasonably be avoided, to minimise Harm to Aboriginal Cultural heritage;
- A practice of respect, understanding and value for Aboriginal Cultural Heritage; and
- That all cultural and intellectual property rights associated with the Mitakoodi and Yulluna People's Aboriginal Cultural heritage remain the property of the Mitakoodi or Yulluna People to the extent permitted by law.

The respective CHMPs make provision for land disturbance, surveys and work plans, reporting, human remains, and protection or destruction of artefacts or sites.

4.17.4 Permitting requirements

Legislation and policy requirements for environmental approvals and environmental management include:

Commonwealth Legislation and Associated Subordinate Legislation

- Environment Protection and Biodiversity Conservation Act 1999 (EPBC 1999)¹⁰
- National Greenhouse and Energy Reporting Act 2007 (NGER 2007).

Queensland Legislation and Associated Subordinate Legislation

- Environmental Protection Act 1994
 - Environmental Protection Regulation 2008
 - Environmental Protection (Air) Policy 2008
 - Environmental Protection (Noise) Policy 2008
 - Environmental Protection (Water) Policy 2008
 - Environmental Protection (Water) Policy 2009
 - Environmental Protection (Waste Management) Policy 2000
- Mineral Resources Act 1989
- Water Act 2000
 - Water Resource (Great Artesian Basin) Plan 2006
- Nature Conservation Act 1992
 - Nature Conservation (Wildlife) Regulation 2006
- Vegetation Management Act 1999
- Land Protection (Pest and Stock Route Management) Act 2002
- Aboriginal Cultural Heritage Act 2003
- Queensland Heritage Act 1992

¹⁰ Cannington Asset does not trigger the environmental criteria of the EPBC 1999.

- Transport Infrastructure Act 1994
- Fisheries Act 1994
- Sustainable Planning Act 2009.

Cannington Operations triggers the Qld *Environmental Protection Act* 1994 as a resource project, and an Environmental Authority ("EA") is issued under this legislation. The EA sets conditions for environmentally relevant activities ("ERA") with the potential to release contaminants into the environment, but also addresses regulated dams, community complaints, biodiversity offsets, and rehabilitation criteria. All permit requirements are addressed in the EA.

4.17.5 Site-specific environmental permits and licences

EA conditions are outlined in the current licence conditions, except where further investigation is required to refine any particular condition. The original EA (#190027) was issued prior to mine operations commencing in 1997. An EA may be amended through due process as operational conditions and constraints change. The most recent EA (EPML00897513) took effect on 26 June 2014. This EA permitted the construction of an additional cell at the northern end of the TSF.

The following ERA regulated under the existing EA occur at Cannington Operations:

- Manufacturing ≥ 200 tpa of explosives
- Storage of ≥ 50 t of Class 1 or Class 2 dangerous chemicals
- Chemical storage of ≥ 500 m³ of Class 3 dangerous goods, and/or Class 1 or Class 2 combustible liquids under AS1940
- Gas fired power generation with a rated capacity of ≥ 10 MW
- Operation of a motor vehicle workshop
- Mineral processing $> 100,000$ tpa
- Crushing screening $> 5,000$ tpa
- Batching ≥ 200 tpa of concrete
- Stockpiling $\geq 50,000$ t of minerals, or unloading ≥ 100 tpd of minerals within 5 km of highest astronomical tide ("HAT") or 1 km of a watercourse
- Waste disposal facility of $< 50,000$ tpa
- Sewage treatment for > 100 but $< 1,500$ equivalent persons.

Notifiable activities include:

- Abrasive blasting for maintenance of the process plant
- Chemical manufacture or formulation at the process plant
- Chemical storage of reagents used in the process plant
- Landfill of general waste generated at the mine site
- Storing hazardous mine waste, i.e. tailings and leach liquor containing some heavy metals disposed of in the tailings storage facility
- Processing of zinc and lead concentrates from ore
- Storage of diesel, oils and waste oil on site.

Exploration activities on various exploration permits is conducted under Environmental Authority EPXS00904713, as well as EPSX00828513 (specifically EPM6788) and EPSX282913 (specifically EPM11676).

Water Licence 93004J covers the construction, operation, monitoring and termination of the GAB borefield, which supplies the majority of Cannington Operations potable and industrial water. This licence is issued under the *Water Act* 2000, is administered by the DNRM, and allows for a maximum extraction of 2,210 ML per annum from up to 18 bores.

EA EPPR00932913 (formerly IPCE00573807B11) for the Townsville port facility was issued under the *Sustainable Planning Act* 2009.

The following environmental permits and licences are required if the mine extension is to proceed:

- Amendment of EA for:
 - Environmental Management Plan
 - Plan of Operation
 - Financial Assurance
- Water licences (Trepell Creek diversion and pit dewatering) (complete)
- Riverine protection permit (Trepell Creek diversion)
- GAB water extraction licence extension
- Development approvals (Trepell Creek diversion)
- CHMP (complete)
- Land holder compensation agreements (complete).

4.17.6 Environmental management

Environmental management at the mine and the Yurbi facility operates under site based environmental management plans and systems. These drive continuous improvement and provides assurance of meeting legal obligations outlined in the EA.

4.17.7 Potential impacts and control measures

Flammable, combustible, and corrosive liquids are stored and used on site. These have the potential to cause environmental damage through toxicity, fire, or corrosion. Storage of flammable and combustible liquids conforms to containment systems in accordance with Australian Standard ("AS") 1940. Corrosive liquids are stored in containment systems in accordance with AS3780.

Rock with acid mine drainage potential is redeposited underground or in the TSF. No rock with AMD potential is stored on the ROM or used for road or construction purposes.

Total dust is not a general environmental issue at the Cannington Operations and Yurbi sites given the remoteness of the sites and the semi-arid nature of the environment. However, dust associated with the mining and processing operation may be contaminated with lead and zinc particles, requiring dust suppression through watering of roads and stockpiles, and covering of loading and unloading facilities as well as transport vehicles. Dust monitoring is conducted at a range of sites, and Cannington Asset are required to respond promptly to complaints or exceedances.

Noise is not a significant issue due to the remote location of the Cannington Operations and Yurbi sites. The nearest resident to the mine is located 3 km away, and there are no residents at Yurbi. Nevertheless, Cannington Asset ensures proper maintenance of plant and vehicle muffler systems, and that mining and processing operations are conducted in accordance the Environmental Protection (Noise) Policy 2008.

Cannington Asset has an active waste management plan that conforms with the intent of the Environmental Protection (Waste Management) Policy 2000 and Environmental Protection (Waste Management) Regulation 2000. Waste streams are separated for appropriate disposal. For example, all (non-contaminated) recyclable materials are taken off site and recycled, while hazardous and potentially hazardous materials e.g. lead contaminated tyres, are disposed of underground or within the tailings storage facility. Hydrocarbon wastes are bioremediated onsite or taken offsite by a licenced contractor.

Cannington Asset manages the site for zero discharge to external waterways, i.e. Hamilton River, Trepell Creek, or groundwater. Water management at Cannington Operations is based on site containment, the separation of clean and contaminated water streams, and

recycling and reuse of contaminated water in operations. A series of environmental catch dams and pump reticulation allow for containment and reuse, with a projected spill or over topping frequency of one spill per 100 years (i.e. 1 per cent chance in any one year). Sediment dams are excavated at or prior to reaching 70 per cent storage capacity.

A containment system has been constructed at the Yurbi site to capture runoff from the storage, vehicle washdown, hardstand, and bunded areas. This includes a concrete sediment settling containment sump to intercept all water from the bunded concentrate containment area.

The EA requires monitoring to ensure that the TSF is not contaminating the local groundwater. The Water Management Plan identifies the monitoring locations, frequencies, parameters, and containment trigger levels to ensure this.

4.17.8 Closure planning

Cannington Asset committed to develop a Closure Plan as part of the Cannington EMOS 2006. Additionally, the DEHP also requires any mine seeking Category 1 performance level (affecting statutory security provisions) be able to demonstrate that the full process of closure planning, i.e. including stakeholder consultation and final land use determination, has been implemented.

Cannington Asset has developed its closure plan to 'Concept' standard as planned closure is more than five years away. The 2014 Closure Plan supersedes the 2013 Closure Plan, reflecting changed regulatory requirements. The plan covers all mining, ore processing, borefield supply, rail transport, port operations, and ancillary activities associated with the mine. The plan is comprehensive, applies a risk-based approach, and addresses operational activities affecting and affected by closure, stakeholder consultation, and future planning, engineering and research required. The plan will be developed to "Feasibility" standard no later than five years from the planned closure.

One amendment to the current 2014 closure plan is the modification of the TSF facility. The 2014 plan considers the rehabilitation of five TSF cells and the end of the mine life. Cannington Asset has since revisited the layout of the TSF facility and will no longer be building cells four and five, but will now increase the height of the existing cells as required. While there is no gain on the overall capex of the project, there is a significant reduction in the closure cost of AUD48 M.

The Standardized Reclamation Cost Estimator ("SRCE") model with Australian labour and equipment cost values is used to estimate closure costs. The SRCE was developed following the Nevada Standardized Unit Cost Project (USA) to facilitate accuracy, completeness and consistency in the calculation of costs for mine site closure and rehabilitation. SRK Consulting has reviewed the predicted closure requirements, costs of closure, and provisioning for mine decommissioning and closure.

Corporate requirements

BHP Billiton Group Level Document 34 – Corporation Alignment Planning – requires:

- Estimation of closure costs.
- Developing design and engineering specifications for structures remaining at closure
- Developing plans for remediation of contaminated sites and decommissioning infrastructure and equipment.
- Determining methods and locations for final treatment and disposal of wastes.
- A monitoring program that verifies post-closure land/infrastructure uses are achieving the completion criteria until relinquishment.

Workforce planning

The Queensland *Industrial Relations Act* 1999 sets the minimum rules for termination of employment for permanent employees. Cannington Asset will apply its human resources procedures to ensure opportunities exist where practicable for staff post closure, to minimise the impact of retrenchment on employees and communities, and to mitigate commercial risks. Cannington Asset will examine the site-specific social implications of closure and enter into dialogue with stakeholders and employees. Retrenchment strategies may include:

- Retraining
- Redeployment
- Counselling and outplacement
- Contracting and other strategies to minimise permanent workforce leading to closure.

Rehabilitation to date

All temporary roads, tracks, and borrow pits required for construction of the mine and process facility have been rehabilitated. Progressive rehabilitation and revegetation of the site is not feasible given that the majority of the workings are underground, although experimentation with establishing ground cover can begin on the sides of the TSF.

Rehabilitation goal

The overall rehabilitation goal associated with closure is to return the land to a condition that will be stable, self-sustaining, non-polluting, safe in the long term, and capable of supporting agreed post-closure land uses with minimal post-closure maintenance. Rehabilitation activities will meet all relevant statutory and corporate requirements as well as relevant international standards.

Regulatory requirements

All conditions of EA EPML00897513 must be adhered to during mine decommissioning, and rehabilitation through to lease surrender. An application to vary or cancel these conditions may be made prior to lease surrender. Key aspects of the EA relevant to mine closure are:

- Maintaining all monitoring and reporting of emissions
- Not exceeding specified emissions limits to air or water
- Removing infrastructure, unless agreed by post mining landholder and the Minister
- Achieving prescribed rehabilitation outcomes as measured against prescribed performance criteria.

Aspects relevant to Water Licence 93004J are:

- Monitoring and reporting on borefield abstraction volumes and piezometric heads
- Submission of monitoring and modelling information to demonstrate restoration of supply to impacted pastoral bores or entering into other arrangements.

Aspects relevant to EA EPPR00932913 (formerly IPCE00573807B11) for closure or sale of the Port of Townsville facility are:

- Compliance with the specified release criteria to water and air
- Use of vehicle wash down to prevent contaminants being inadvertently carried off site
- Transport of regulated waste according to relevant regulations.

Infrastructure, equipment and landform

Closure Plan 2014 identifies that hazardous materials and structures without agreements with the post mining landholder and the Minister will be removed from site and disposed of in a safe and non-polluting manner, or buried within the mine. Gas and water pipelines and associated infrastructure may be sealed, disposed of or buried. All unwanted holes will be backfilled and concrete will be disposed of underground. Retained infrastructure will be decontaminated and surveyed to ensure that it is safe.

The Cannington Operations will be partially rehabilitated through ripping of compacted surfaces, re-contouring to its previous topography, and revegetated. The airstrip is likely to be retained as will borrow pits that function as water storages. Additional infrastructure may be retained upon agreement with the post mine landholder.

Infrastructure at the Cannington borefield will be removed and the site rehabilitated, unless there is agreement to retain some or all of the pump infrastructure.

The Yurbi loadout facility will be fully rehabilitated (the rail loop belongs to Queensland State Infrastructure and will not be removed by Cannington Asset) or decontaminated and sold upon agreement.

Ownership of the shiploader must be passed to the Townsville Port Authority upon closure. The site will be decontaminated and rehabilitated, or sold. The 2013 Closure Plan accounted for complete rehabilitation of the site, however the 2014 Closure Plan proposes that the site be decontaminated if required, and sold.

Post mining land use

The land will be returned to its pre-mining condition, i.e. Mitchell Grassland with some woodland, and pre-mining use, i.e. low intensity grazing. Certain sites within the area, such as the tailings dam, will be unsuitable for grazing and will be engineered to discourage stock access.

4.18 Cost assumptions

4.18.1 Capital costs

Mining

Figure 4.17 summarises the major areas of capital expenditure forecast for the Cannington underground mining operation. Mine development in waste is capitalised and there is an ongoing requirement for waste development to provide access to new stopes.

A major capital project (USD41 M) has been planned to commence in FY17 to relocate the existing underground crusher to enable access to the high-grade ore in the crusher exclusion zone.

Figure 4.17: Mining Forecast Capital Expenditure – FYs 2016 to 2023 (Nominal)

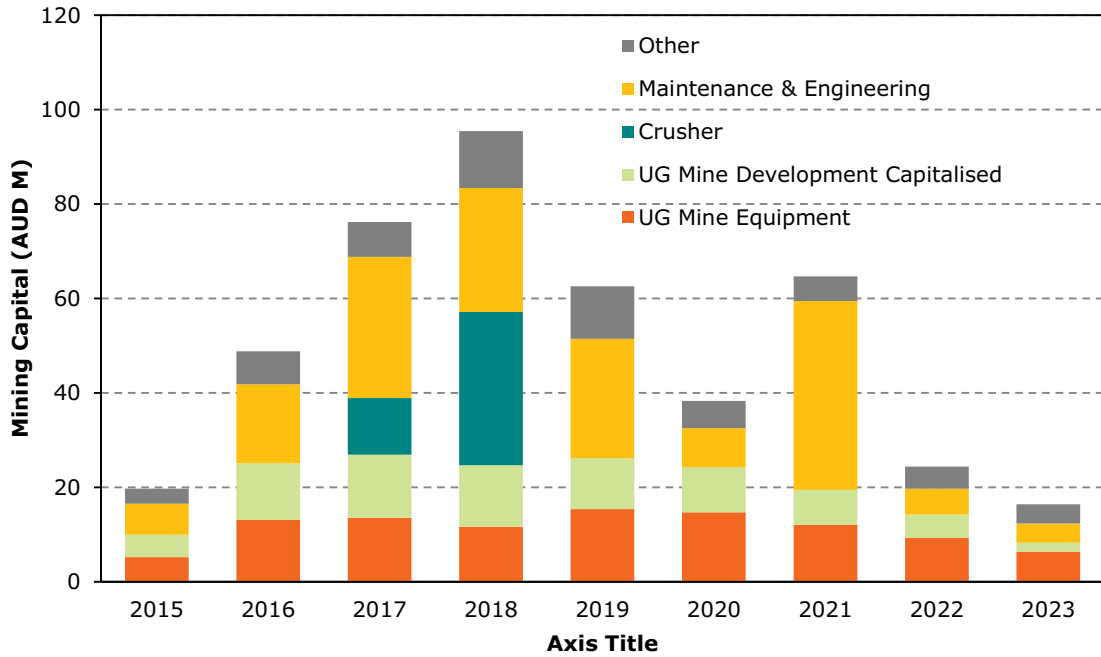

Source: Cannington Asset

Processing

The processing plant future capital cost expenditures centre mostly about lifting walls of the existing TSF cells as well as constructing Cell 3. The total costs from mid-FY15 to end of life in FY23 is USD36.3 M (real). No details were supplied but it is evident that most of the costs relate to the TSF constructions, which can be considered necessities and needed in order to stay in business. There appears to be a minor amount of approximately USD1 M to USD2 M annually for general sustaining capital expenditures for general items such as light vehicles, equipment replacement and other minor capital expenditures. Figure 4.18 summarises the annual forecast capital costs for the LOA from mid-2015 onwards.

Figure 4.18: Processing Forecast Capital Expenditure – 2015 to 2023 (Nominal)

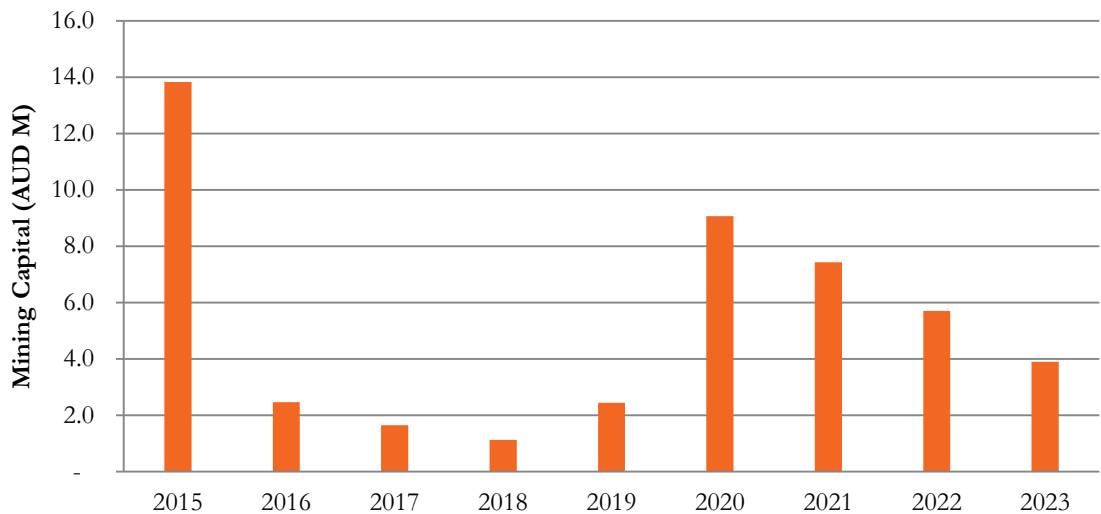

Source: Cannington Asset

4.18.2 Operating costs

Underground mine

Figure 4.19 presents Cannington Asset’s forecast mine operating costs. These average about AUD52/wmt, and are in line with recent historical actuals and appear reasonable.

Figure 4.19: Mining Forecast Operating Expenditure – FYs 2016 to 2023

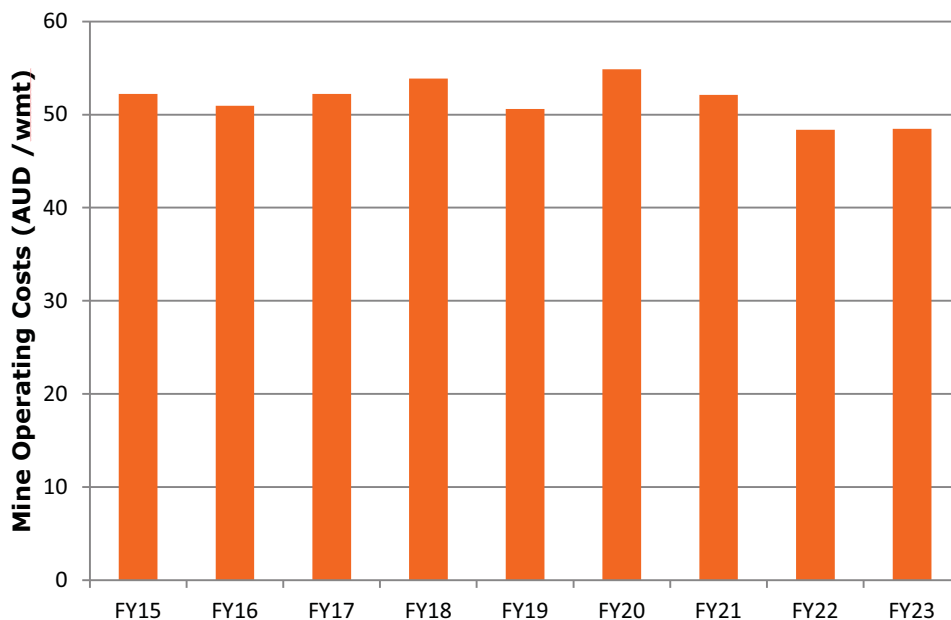

Source: Cannington Asset

Processing

Figure 4.20 presents Cannington Asset’s forecast process plant operating costs for the forecast period Q2 FY15 to FY23. These average approximately AUD24.3/t of throughput.

Figure 4.20: Processing Forecast Operating Costs – FYs Q2 2015 to 2023

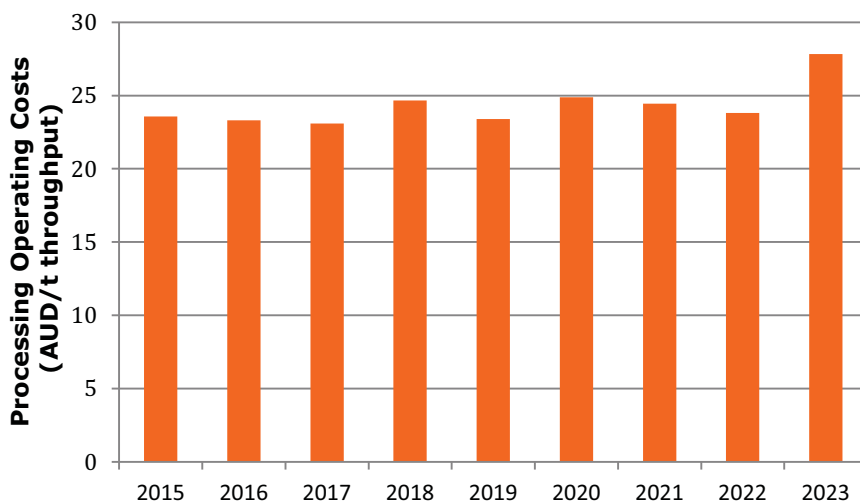

Source: Cannington Asset



The process operating costs includes:

- Stockpile costs relating to contract labour on the stockpile based on a fixed cost of AUD12.5 M per annum plus a unit cost of AUD0.036/wmt hoisted from underground.
- Crushing costs are variable and relate to power consumed.
- Milling costs related primarily to power usage (66 per cent of milling costs).
- Flotation costs comprising mainly power (44 per cent) with reagents making up the remainder.
- Dewatering costs include the leaching of both concentrates to reduce fluorine. Power costs comprise about 27 per cent of the dewatering costs with the remainder related to reagents, maintenance parts and filter clothes.
- Tailings Disposal costs comprising mainly power.
- Overhead costs are assumed to be all fixed and related to labour with some minor other costs.

The process plant operating costs on an annual basis appear very consistent. While the past cost data is sparse the forecast costs exceed what has been experienced from May 2013 to April 2014 with an approximate average of AUD21.50/t. In addition, the September 2014 reported unit cost of AUD27.35/t (dry) compared with the September budget of AUD24.20/t.

It should be noted that power costs are a significant cost for the processing plant comprising 32 per cent of the total operating cost and averaging for the forecast period at AUD7.74/t treated. Thus, any change in power costs will reflect significantly on the process plant costs.

Concentrate transport

In addition to the on-site process plant, there are costs incurred relating to shipment of the concentrates as summarised in Figure 4.21.

Figure 4.21: Concentrate Transport Forecast Operating Costs – FYs Q2 2015 to 2023

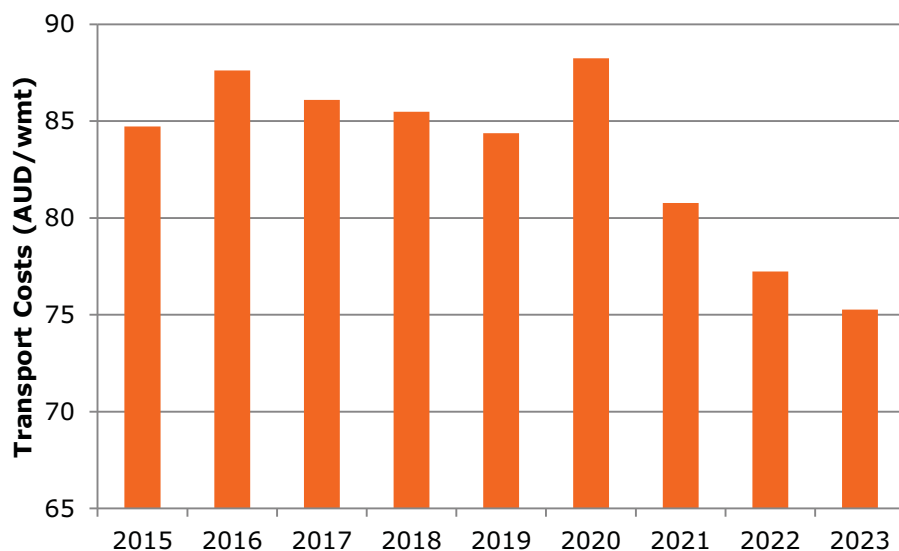

Source: Cannington Asset

The main reason that there are some changes in unit costs relate to changes in “fixed” port charges and a cessation of the fixed rail costs after 2016. These costs appear reasonable based on history. They possibly could be reduced if some of the lead concentrates could be

processed at Xstrata’s Mount Isa operation however, the high Ag values may preclude that opportunity.

There are other shipment costs that can be summarised in Figure 4.22.

Figure 4.22: Concentrate Shipping Forecast Operating Costs (AUD M) – FYs Q2 2015 to 2023

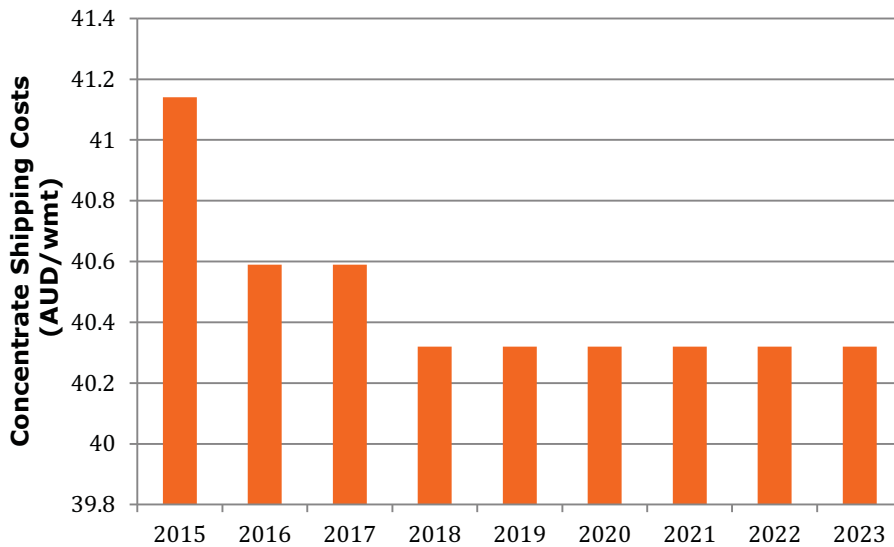

Source: Cannington Asset

As noted above, these costs are standard.

In summary, Xstrata consider the process plant site operating costs to be reasonable and acceptable given the historical performance, the complexity of the processing flowsheet and the maturity of the operation.

The transport and shipping costs, although high are acceptable given the project location and the complex logistics getting the product to smelter markets.

G&A operating costs

The General and Administration (“G&A”) site operating costs relate to most of the un-allocable costs such as FIFO, Information Technology, corporate charges, Health, Safety Environment and Community (“HSEC”) and a number of other costs. In addition, there are charges incurred by the Townsville office. Figure 4.23 summarises these costs.

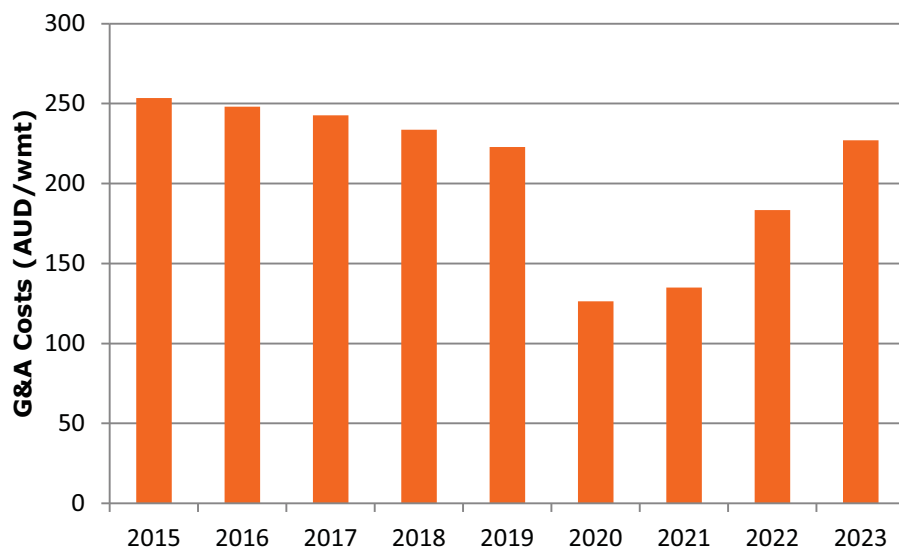

Figure 4.23: General and Administration Forecast Operating Costs – FYs Q2 2015 to 2023

Source: Cannington Asset

The significant reductions in 2020 onwards relate to forecast credits resulting from the implementation of the “Miser” programme.

Closure costs

Current Australian labour and equipment costs have been applied to the SRCE to estimate Cannington Operations closure costs. Raw cost estimates and changes in assumptions from the previous year have been appended in the 2014 Closure Plan.

Closure costs are estimated for:

- Technical planning, using in-house and consultant expertise
- Decontamination; investigation and disposal
- Decommissioning; dismantling and demolition; infrastructure removal and salvage
- Rehabilitation; earthworks and stabilisation, including establishment of landforms, drainage paths, closure infrastructure and revegetation
- Post closure management; monitoring and maintenance
- Human resources; retrenchment and counselling, retraining, redeployment.

The most significant direct cost (approximately 50 per cent of total) is for the closure and capping of the Tailings Storage Facility, while the most significant indirect cost (approximately 20 per cent of total) is for human resource management.

4.19 Risk and opportunities

4.19.1 Geology/Resources

The risk of grade estimation inaccuracy from a simplistic approach is mitigated by the level of detailed geological knowledge and high density of sample data. An opportunity to improve the quality of local grade variability modelling, which leads to improved mining selectivity, arises from this risk.

Current block estimation dimensions exceed the minimum selective mining unit width in the easting direction and equals the drill spacing along strike, leading to possible misclassification of ore and waste through the incorporation of grade dilution at stope

boundaries. Mining selectivity can be further optimised through the modelling of grade variation at considerably smaller block sizes.

A conservative Mineral Resource classification creates a risk of understating the Mineral Resource that could potentially lead to impeding the rate of development of new mining areas. The integration of geological and grade continuity with Mineral Resource classification creates the opportunity to increase the scale and proportion of higher confidence Mineral Resources whilst also optimising drill spacing to reduce future capital expenditure.

The inclusion of an additional 700 drill holes, drilled between 2012 and 2014, into future Mineral Resource estimates hold significant potential to increase the Cannington Mineral Resource estimate scale and confidence.

The significant reduction, and then termination, of regional exploration funding after FY16 appears to be consistent with near mine exploration being the more significant opportunity to increase Mineral Resources on the scale of the Cannington deposit. Structural repetition of Cannington mineralisation both along strike from faulting and across strike from folding creates this potential.

4.19.2 Mining/Ore Reserves

The Cannington Operations are a long-established operation, which has worked through the majority of risks normally associated with mining. Hand-in-hand with the risks that have been identified are some potential opportunities able to add value to the mine should they be investigated and implemented.

- **Head Grade:** The mining extraction factors, as currently applied, possibly overstate the Ore Reserve grade as they do not consider the increasing ratio of secondary and tertiary stopes and decreasing stope size.
- **Mine Production Rates:** Cannington Operations has undergone a number of expansion projects since commissioning at 1.5 Mtpa in 1997. Sustaining production rates will become increasingly difficult as the Ore Reserve is depleted. The average stope size materially decreases as larger more productive stopes are mined requiring an increasingly greater number of stopes to be mined each year. The number of available stoping fronts will diminish with an increasing proportion of secondary and tertiary stopes. Mine planning and operational legacy issues are also likely to impact on the ability to sustain production.
- **Underground Mine Infrastructure:** Much of the mine access, ore handling and service infrastructure is located in the amphibolite core of the deposit or within the ore. Provision has been made in the mine plan for a replacement crusher to allow for the extraction of high-grade ore within the crusher exclusion zone towards the end of mine life. Decommissioning and replacement of the current ore handling system has the potential for significant production disruptions. Deteriorating ground conditions should be expected as the mine ages and stresses are redistributed around mining zones. Potential localised ground failures and rehabilitation requirements could become a factor on the ability to maintain access and mine services to achieve anticipated production levels if they are not monitored and managed.

Opportunities for in future mining include:

- **Reserve Tonnes:** 5 Mt in the North Upper and North Outer blocks are currently under evaluation. It is expected that these blocks will be included in the Ore Reserve at completion of the current evaluation exercise. Designed stopes have been excised from the current Ore Reserve because they are scheduled beyond 2023 when sustainable mine production rates cannot be achieved (to cover fixed costs). Potential exists to lower the cut-off grade and re-scheduling to minimise any residual production

tail thereby including material that could not otherwise be mined economically. Any Inferred Resource material within designed stope wireframes (approximately 10 per cent) is not included in the Ore Reserve. Xstract expects this material would be upgraded to Ore Reserve status during the final stope design process.

- **Remnants:** Cannington Operations contains some exceptionally high-grade remnants (>AUD500/t) that are unlikely to be amenable to extraction using current mining methods. Alternate mining methods/equipment may provide to opportunity to mine a proportion of these remnants. Extraction of these remnants would have to be planned and executed while the operation can sustain viable total production rates.
- **Open pit potential:** A number of open pit studies have been previously carried out. Any potential open pit would likely target the shallower low-grade ore above the North Zone and extend to depth over the Southern Zone chasing high remnant ore grade as assumed metal prices are increased. At current price forecasts no open pit is included in the mine plan, however, the potential exists if there is a material increase in metal prices (particularly for silver).

4.19.3 Mineral processing

The Cannington Operations processing plant has the benefit of 17 years of continuous operation. The main conceivable operating risk for the processing plant would be an AG mill failure. Xstract considers this possibility very low, although the associated consequences would be a significant impact for a period of up to three months production interruption.

However, Xstract considers the on-going maintenance practices at Cannington Operations are reasonable. If there were to be any structural problems with the mill shell, ring-gear or heads, these would be signalled early using non-destructive testing, as well as thermal monitoring. The mill is a relatively small AG at 8.53 m diameter by 3.96 m long (28 feet by 13 feet) and powered by a 5.8 MW motor. Historically, these mills have not suffered the problems of the larger units used in a semi-autogenous configuration. Therefore, Xstract consider any failure is highly unlikely.

Other equipment failures would possibly slow throughput for a few days but nothing significant would be experienced as much of the equipment is either covered by a spare or there are two in the circuit thereby reducing the impact on production.

Xstract considers it unlikely that metallurgical performance will change, unless there is a major change in ore mineralogy. Xstract is not aware of such a change as currently scheduled in the LOA. However, there is a possibility that metallurgical performance could deteriorate more than forecast as the head grades drop. This could be at least forewarned by bench-scale metallurgical testwork conducted on drill core from future mined areas. The testwork could also provide some mitigating data such as changing reagent regimes or particle size distribution if necessary.

A minor disruption could occur with freight of reagents and consumables due to road wash-outs after severe cyclonic storms. The operating protocol allows for a certain amount of reagent to be stored on-site in inventory to allow for a two to three week outage.

4.19.4 Environmental

A risk assessment was carried out as part of the closure planning process and is included as an appendix to that report. Table 4.17 provides a summary of identified risk and the likelihood following existing controls.

Table 4.17: Summary of risk and likelihood assessment conducted for Closure Plan 2014

Risk	Likelihood
Failure to close mine successfully	Possible
Inaccurate closure cost assessment	Unlikely
Failure to achieve final land use	Rare
Failure of equipment/structures during demolition	Unlikely
Safety hazard to animals/people by removal of existing safety barriers and controls	Unlikely
Acid Rock Drainage/Metal leaching resulting in poor quality runoff/groundwater/seepage worse than predicted levels	Possible
Poor quality runoff and seepage	Unlikely
Contamination of livestock from consumption of plants that have high metals readings detected during routine testing	Rare
Failure to achieve re-vegetation success criteria	Likely ¹
Unidentified hydrocarbon and hazardous chemicals contamination from fuel and lubricant storage area (including underground pipelines)	Unlikely
More contaminated soils than estimated outside of the investigated area	Possible
Erosion of drainage lines, dams, spillways and failure of sediment traps	Unlikely
Failure to achieve the administrative authority rehabilitation guidelines and requirements to achieve relinquishment	Likely ¹
Subsidence related to underground workings before relinquishment	Rare
Vent raise, shaft cap fails	Rare
Degrading groundwater quality due to containment migration	Unlikely
Actual cost exceeds modelled cost for HR issues when closing Cannington Operations	Possible
Early closure of Cannington Operations	Unlikely

¹ The local environment is subject to extreme droughts and heavy rains, which may affect revegetation success depending on timing of event.

The 2014 Closure Plan has modelled the costs of complete closure if the mine were to close immediately. This liability is accounted for in the Cannington Asset's Balance Sheet for the current financial year.

5 Regional exploration assets

5.1 Introduction

In addition to the Cannington MLs, BHPB Minerals also holds 13 granted EPMS, which stretch discontinuously for some 100 km to the north and 150 km to the south of Cannington Operations (Figure 5.1). These tenements all lie along a north-south trend, which coincides with the interpreted extents of the Proterozoic Soldiers Cap and Fullarton

River Groups. The principal exploration target is BHT lead-zinc-silver mineralisation similar to that at the nearby Cannington Operations, Pegmont, Altia and Maronan deposits.

Figure 5.1: Location of BHPB Minerals' regional exploration permits

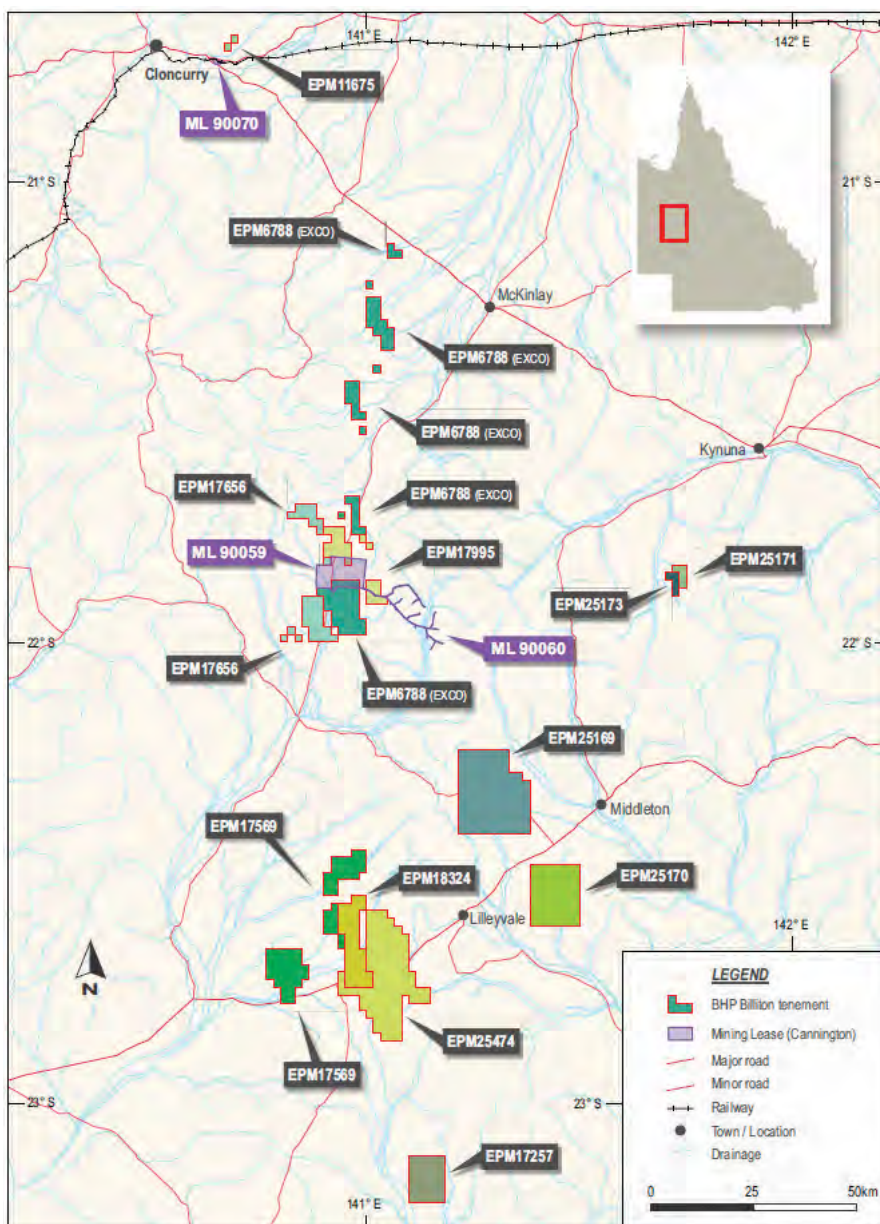

Source: BHPB Minerals, Xstract

Most of the prospective Proterozoic basement rocks in region are covered by variable thicknesses of flat-lying Mesozoic sediments assigned to the Eromanga Basin. This has forced previous explorers to rely heavily on geophysical surveying as the main exploration tool. In the past, BHP Billiton has completed a number of regional and detailed aeromagnetic, ground magnetic, electromagnetic, regional gravity and GEOTEM surveys across the region, building up an extremely valuable geophysical database.

With the exception of EPM6788 and EPM11675, all tenements have been granted within the past three years and hence remain in the early stages of assessment.

Given declining lead and silver grades at Cannington Operations, and deferral in the open pit plan, Cannington Asset's exploration efforts are heavily focussed on the discovery of

additional near-mine, silver-rich deposits associated with the Soldier Cap Group. Based on a five-year discovery and development window, Cannington Asset's objectives are to discover:

- a deposit exceeding 15 Mt with grades above 250 g/t silver within 25 km of Cannington Operations in the short term (1 to 3 years), and
- a deposit exceeding 25 Mt at grades of above 300 g/t silver within 100 km of Cannington Operations over the longer term (3 to 5 years).

While Xstract does not consider the regional exploration assets to be material in terms of the overall value assigned to the Cannington Asset, they are important as they provide further growth options going forward and hence are summarised briefly here for completeness.

Importantly, as part of its regional exploration programme, Cannington Asset is evaluating a number of geological, geochemical and geophysical anomalies and targets. By definition, these anomalies and targets are conceptual in nature and require further investigation and studies before a Mineral Resource can be reported in accordance with the JORC Code guidelines. There is no guarantee that such targets will convert to a Mineral Resource.

5.2 Southern Domain Project

Cannington Asset's Southern Domain Project comprises EPMs 17257, 17569, 18324, 25169, 25170 and 25474, which are centred approximately 120 km south to southeast of the Cannington Operations. The Southern Domain Project represents the focal point for Cannington Asset's ongoing regional exploration.

Access to the project is via a network of graded station tracks leading off the Kennedy Developmental Road, McKinlay to Boulia Road and the Cork Mackunda Road. Topographically, the project area is flat to gently undulating channel country, with minor mesa formations. The streams draining the area flow to the south and southwest.

The dominant lithologies across the area comprises the basal units of the Soldiers Cap Group (Llewellyn Creek Formation, Mount Norna Quartzite and Toole Creek Volcanics), as well as the underlying Fullarton River Group (Gandry Dam Gneiss and Glen Idol Schist).

Since the initial permits were granted in 2011, BHP Minerals has completed desktop reviews, cultural heritage clearing, aeromagnetic interpretation, detailed ground gravity surveying, geophysical modelling, geochemical sampling and limited drilling over the Southern Domain Project area.

The majority of this exploration has been focussed on EPM17569 and EPM18324, in particular detailed ground gravity and magnetic geophysical surveying, and diamond drilling of regional geophysical targets at Dover East, Lucknow, Parisian Creek and Dover Bore, as well as several linear north-south striking magnetic anomalies known as the Pollygammon target. Encouraging stratigraphy, BHT alteration signatures and geochemical results have been encountered and are providing the basis for exploration activities going forward.

At the time of review, seven of eight planned diamond drill holes on EPM18324 and six diamond drill holes on EPM17569 had been recently completed. Drilling is testing targets under 400 m of cover and up to 1,00m deep. Logging identified trace amounts of sulphide mineralisation, dominated by pyrrhotite, in both areas. Cannington Asset were awaiting assay results.

Given the presence of variable cover ranging from 200 m to 600 m across the area, the Project remains very much under explored.

5.3 Cannington Near Environs Project

The Cannington Near Environs Project consists of three granted permits, EPMs 17656, 17995 and 19038, which all lie adjacent to and surround the Cannington ML.

Like Cannington Operations, the geology of the area includes outcropping Corella Formation in the north, basal units of the Soldiers Cap Group (predominantly Mount Norna Quartzite and Toole Creek Volcanics), as well as the underlying Fullarton River Group (Gandry Dam Gneiss and Glen Idol Schist) beneath Mesozoic sediments of the Eromanga Basin and Quaternary alluvial sediments. Interpreted to underlie the Soldiers Cap Group in the Cannington Operations area, the strongly magnetic calcareous metasediments, limestone and marble of the Doherty and Corella Formations are strongly brecciated. To the east of Cannington Operations, the depth to basement is estimated at between 100 to 300 m.

In the past, BHP Billiton has completed a number of aeromagnetic, regional gravity and GEOTEM surveys in the Cannington area.

Since the recent grant of these tenements, Cannington Asset's exploration activities have comprised desktop review, ground reconnaissance and target generation through modelling of existing datasets and a review of historical drilling activities. These activities have identified two small magnetic highs with an associated gravity response extending over a 1 km strike length adjacent to Cloncurry Fault and northwest of Cannington Operations. The targeted area lies very close to intersection of north-south Cloncurry Fault and major northwest-southeast trending fault that may be linked to the Hamilton Fault Zone adjacent to the Cannington ore body.

Geological and magnetic interpretation suggests the target lies within the Mount Norna Quartzite surrounded by units of the Corella Formation. The Corella Formation is interpreted to have been folded about a synform or antiform structure. Further exploration is proposed to gain a better understanding of the structural relationships in this area.

5.4 Soldiers Cap Joint Venture Project

The Soldiers Cap Project consists of a single granted exploration permit, EPM6788, which extends discontinuously southwards from the Landsborough Highway to some 15 km south of the Cannington ML. It is explored under a joint venture between BHP Billiton and Exco, with Exco responsible for the sub-blocks north of Cannington Operations, and Cannington Asset responsible for the sub-blocks immediately adjacent to, and south of, Cannington Operations.

Metamorphic grade increases from largely greenschist facies with abundant sedimentary textures in the north, to upper amphibolite facies comprising schists and migmatitic gneisses to the south of Cannington Operations. The area is largely devoid of outcrop with Mesozoic sediments of the Eromanga Basin covering the Proterozoic basement.

The focus of recent exploration has been directed to those sub-blocks located to the south of the Cannington ML, in particular the magnetic anomalies at the Hamilton area (5 to 15 km to the south of Cannington Operations), and a target 2 km to the southeast of the Cannington Operations outside of ML90059.

Following limited drilling, the majority of the magnetic targets can be explained by either magnetic gneisses and psammities or magnetic amphibolite units. Of interest is historic diamond drillhole, CAD552 in the Hamilton area, which encountered prospective stratigraphy and anomalous geochemistry indicative of distal BHT mineralisation. However, more recent drilling has been unable to repeat these results.

Based on promising intersections in earlier drilling, its proximity to Cannington Operations, and the presence of a number of key BHT affinities observed, the Hamilton area is likely to remain a focus for near-mine exploration at least in the near term.

5.5 Cloncurry Project

The Cloncurry Project comprises a single granted exploration permit, EPM 11675, located some 18 km east of Cloncurry and 110 km north of Cannington Operations. Access is along the sealed Flinders Highway and station tracks.

Exploration at EPM11675 is managed by Exco under the terms of the BHPB Minerals – Exco alliance, which commenced in 1998. Under this alliance, Exco holds the rights to all copper and gold mineralisation within EPM11675.

Recent exploration on EPM11675 has concentrated on the evaluation of the Salebury, Uncle Tom and Crows Nest prospects, which are considered prospective for alluvial gold, oxide copper and Ernest Henry type copper-gold mineralisation. In summary:

- The Salebury prospect occurs on the southern limb of the Pumpkin Gully Syncline at the northeast-southwest trending contact between shales and the Toole Creek Volcanics. The prospect hosts a number of minor historical workings including a small open cut that leads to underground workings. Mineralisation is irregularly distributed, occurring in a number of sub-parallel lodes within a brecciated and sheared carbonate-veined black shale sequence, with associated dolerite intrusions. The mineralisation is dominated by chalcocite. Calc-silicate breccia bodies also occur within the prospect area. In October 2012, Exco reported a JORC Code compliant Indicated and Inferred Resource for the Salebury copper-gold deposit. As all rights to the deposit reside with Exco, the Salebury deposit is not discussed further.
- The Uncle Tom prospect is an area of historical diggings, which coincides with an alluvial gold occurrence (Pumpkin Gully) and strong gold-in-soil geochemical anomaly. Initial limited drill testing of the prospect did not return any significant assay results.
- At the Crows Nest prospect, extensive diggings occur over an apparent strike length of more than 600 m. Some deeper historical RC holes were completed as follow-up to the shallow traverses, and some anomalous copper and gold assays returned. The geometry and geological controls of the mineralisation have not been confidently established. Induced Polarisation geophysical surveying and limited drilling were completed in 2008, with no significant results returned.

BHPB Minerals recently completed an evaluation of EPM11675 and is currently in discussions with Exco regarding the exploration strategy going forward.

5.6 Regional

Cannington Assets regional program includes two permits, EPMs 25171 and 25173, which are located east and southeast of the Cannington Mine. As these permits were only granted in April 2014, exploration activities have not yet commenced.

5.7 Exploration expenditure

Exploration expenditure weighting increases from 78 per cent to 100 per cent on developing near mine targets over the coming two financial years. Additional exploration beyond that term will largely be determined on the results of existing programs and whether further work is warranted.

Table 5.1: Actual and Forecast Exploration Expenditure (AUD M) – FYs 2012 to 2017

	FY12	FY13	FY14	FY15	FY16	FY17	TOTAL
Near Mine	9	5.5	6.1	5.8	6.2	-	32.6
Regional	3.8	1	1.8	1	-	-	7.6
Underground	0.3	1.3	-	0.7	-	-	2.3
TOTAL	13.1	7.8	7.9	7.5	6.2	-	42.5

Source: Cannington Asset

6 Special factors

The Australian mining and minerals industry is characterised by several factors including:

- continued Asian investment in Australian mineral projects
- relatively high demand for Australian mineral exports
- persistently high costs of labour, electricity, diesel and steel along with the resultant corporate measures to improve productivity and cut costs
- comparatively high unemployment in the mineral sector following waning 'boom time' conditions
- transition of the sector from investment/construction to the production phase, with little capital available for the mid-tiers and juniors
- transition from domestic to export market oriented gas prices likely to result in higher domestic prices in the near to medium term
- rising opposition to, and increased regulation of, mining in areas considered to be of strategic importance (i.e. coal seam gas opponents, Wild Rivers and Strategic Cropping Land legislation)
- ongoing, but receding, uncertainty relating to mineral resource taxation, carbon scheme, mineral royalties and other duties (i.e. fuel)
- depreciating AUD has eased pressures on local businesses and compensated for lower commodity prices.

Following the demerger, Cannington Asset will no longer have the same level of protection as afforded under BHP Billiton's ownership. Xstract considers that any one, or a combination, of these factors may result in unexpected impacts on the business of Cannington Asset.

6.1 Adjacent projects

The Cannington Asset is attractive to the market, and may hold strategic value, given (i) its high-value, silver-rich concentrates, (ii) competitive, low-cost, high margin structure, and (iii) proximity to other globally significant base metal operations and/or developments, including Shanxi Donghui's Osborne Mine, Glencore's Mount Isa, Lady Loretta and Ernest Henry Mines, as well as MMG's Dugald River and Altona's Roseby development projects.

7 Market analysis

Xstract conducted a high-level assessment of the prevailing market in order to assess the economic environment in which Cannington Asset operates. The market analysis has involved a data gathering exercise of up to date metrics and forecasts for metal supply and demand, commodity pricing (for silver, lead and zinc), inflation and foreign exchange rates.

7.1 Lead

The global lead market equates to approximately 10 to 11 Mt of metal production. Around half of this metal is derived from primary supply (i.e. lead mining), with the remaining half supplied from recycling activities. The top lead mining countries are China, Australia, the USA and Peru, and the top country by consumption is China.

Lead products are dominated by the use in batteries at around 80 per cent of lead consumption. Other principal uses of lead include sheathing and protection (from rolled products), and pigments in compounds.

The market for lead products is growing at a slow pace and it is expected that global lead will increase at a gentle pace over the next few years. However, recycling is likely to account for most of the increase in lead metal production, as both recycling technology and availability increases.

The lead price typically has less volatility than most other traded commodities, being range bound between USD2,000 to 2,300/t (refined metal) for the last 18 months. Similar to both silver and zinc, lead is commonly mined in poly-metallic operations, such as the Cannington Operations. Importantly, newer zinc mines, which are set to bring production online contain lower lead concentrations than has historically been the case. Constrained supply is likely to underpin the current lead price. However, demand for lead is unlikely to reach the highs of 2011 anytime soon, with the highest lead price in recent history only around USD3,500 per tonne.

The lead forecast is therefore based on gently increasing demand with a corresponding amount of supply being constrained at mines (primary) but growing in recycling (secondary).

7.2 Zinc

The zinc market, and demand for zinc and zinc products, is correlated with general construction and typical industrial demand. Nearly 60 per cent of zinc metal is used in galvanising, and die casting, alloys and brass and select chemicals make up the remainder of the zinc market. Zinc is consumed by the construction, transport, electrical and consumer goods sectors.

Primary zinc accounts for over 75 per cent of the 12 to 13 Mtpa market for zinc metal and secondary (or recycling) is less than 25 per cent. Zinc is mined in a large number of countries, predominantly from underground mines, with China, Australia, Peru, India and Canada accounting for some 75 per cent of primary zinc production. Mines usually produce a concentrate product of some 50 to 55 per cent zinc content, which is shipped to smelters for smelting and refining into zinc metal. The largest zinc smelting nation is China, followed by Canada, Japan, Korea and India.

The zinc price correlation to general industrial demand favours a forward zinc price, which is higher than the present. A number of strong opportunities exist within the zinc market over the next decade. For example, in China around 5 per cent of flat steel products have some form of galvanization, whereas this figure is above 15 per cent in the USA and Europe. China is expected to have reasonably strong, but not growing, demand over the next period.

On the supply side, a number of zinc mines are either contracting or closing. The net contraction, predicted to occur during 2017 to 2018, is around 11 per cent of primary zinc production. This contraction effect is not expected to flow on higher prices in the immediate future, however will underpin the zinc market in the longer term.

The all-time high zinc price was in 2007, settling just above USD4,000/t, which was due to a number of regulatory changes in the Chinese steel industry, which have since been adjusted.

7.3 Silver

The silver market is around 900 M to 1 Bn ounces of produced silver per year. Silver is mostly used in industrial applications with industrial and photography applications demanding nearly 75 per cent and jewellery, coins and silverware being the balance of the silver market.

The top three silver producing countries are Mexico, Peru and China with each accounting for more than 12 per cent of silver production. Globally, Australia's silver production is fourth and Cannington Operations is the largest producing silver mine in the world. The dominant demand countries are China and India, where both industrial and jewellery applications use silver.

Silver's exposure to both industrial and precious applications means that the demand base for silver metal is relatively stable, even if the commodity price remains as volatile as other precious metals, such as gold, or other industrials, such as copper. Silver is used in technological applications, which leads to silver demand forecasts remaining strong in the future. Silver is used in cars (including electric cars and other electric vehicles), computers, phones and tablet devices, televisions and photovoltaic solar power equipment.

The supply of silver into the market comes from mines, scrap (recycling) and government sales. The silver market is around 75 per cent supplied by mines, which are a combination of silver mines and polymetallic operations. Most mined silver is a co-product or a by-product, as is the case with Cannington Operations. The silver price is therefore somewhat exposed to the general commodity and industrial market.

During 2011, the silver price reached all-time record highs (USD47/oz). Since then, silver has been well supplied into the market, despite demand remaining strong. This strong supply has kept prices trending around the current levels (i.e. USD15 to 20/oz).

Over the medium to longer term, the silver price is expected to increase due to the net demand effect.

7.4 Price analysis

7.4.1 Metal prices

In determining appropriate prices to apply to Cannington Asset's forecast sales, Xstract has had regard to the following:

- our understanding of potential future demand for lead, zinc and silver on export markets;
- our understanding of Cannington Asset's realised lead, zinc and silver prices currently being achieved under recent contracts for concentrate sales;
- market participants expectations and forecasts regarding treatment and refining charges; and
- pricing assumptions and forecasts used by industry analysts and within recent publicly available Independent Expert Reports.

Given the potential range of metal prices is ultimately driven by the future supply and demand, Xstract has adopted market consensus metal price forecasts in nominal terms as published by Consensus Economics (October 2014). Figure 7.1 illustrates both the historic and forecast metal prices used in this valuation.

Figure 7.1: Consensus forecast metal prices

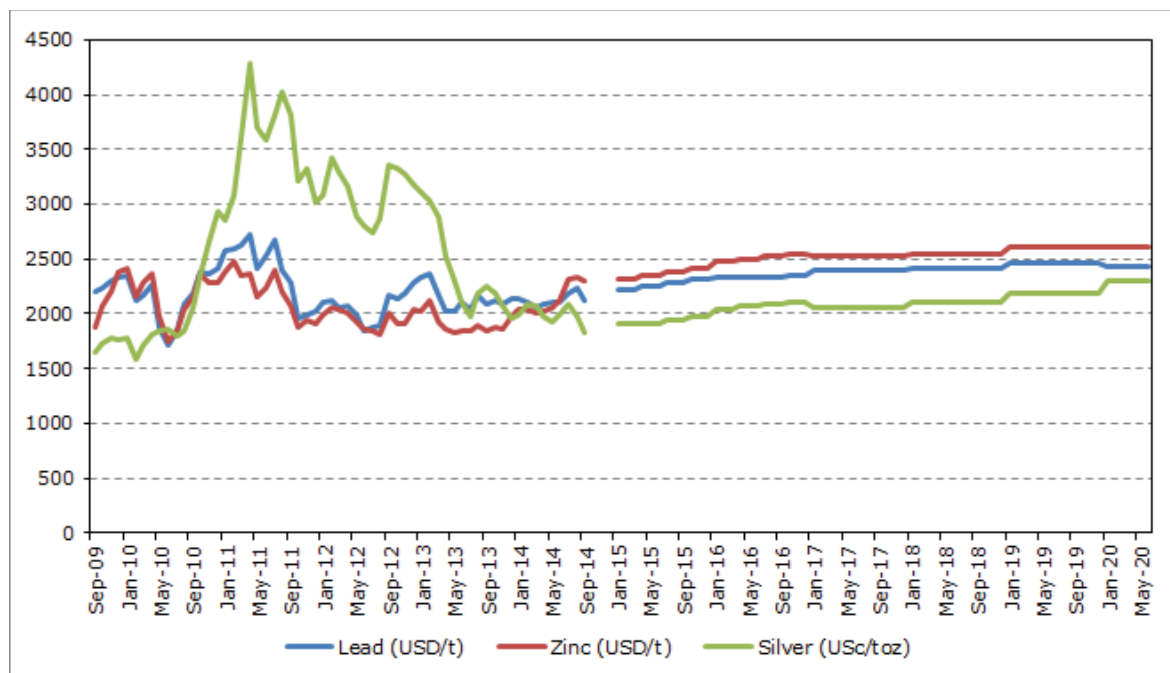

Source: Consensus Economics

7.4.2 Treatment and refining charges

In late February 2014, Metal Bulletin reported that Cannington Asset settled its lead concentrate contract at a treatment charge (“TC”) of USD197.50/t and a refining charge (“RC”) for silver of USD1.50/toz. The TC was down from USD230/t in 2013. On average, these TC settlements are approximately 10 per cent of the London Metals Exchange (“LME”) lead price. In determining the forecast lead concentrate TC for the valuation of Cannington Asset’s Ore Reserves, Xstract has multiplied the consensus lead forecast price by 10 per cent. Xstract has applied 7 per cent to the forecast silver price to determine the silver refining charge (Figure 7.2).

In April 2014, Teck Resources agreed with Glencore to sell 200,000 t of zinc concentrate at a 2014 TC of USD223/t. In 2013, Teck Resources agreed to USD210.50/t with Korea Zinc. Also in 2013, Lundin Mining agreed a zinc TC of USD212/t based on a price of USD2,000/t of refined metal. Xstract notes that these settlement TC’s are approximately 11 per cent of the LME zinc price. Xstract has multiplied the consensus forecast zinc price by 11 per cent to determine the projected zinc concentrate TC for the valuation of Cannington Asset’s Ore Reserves.

Figure 7.2: Forecast lead and zinc treatment charges and silver refining charge

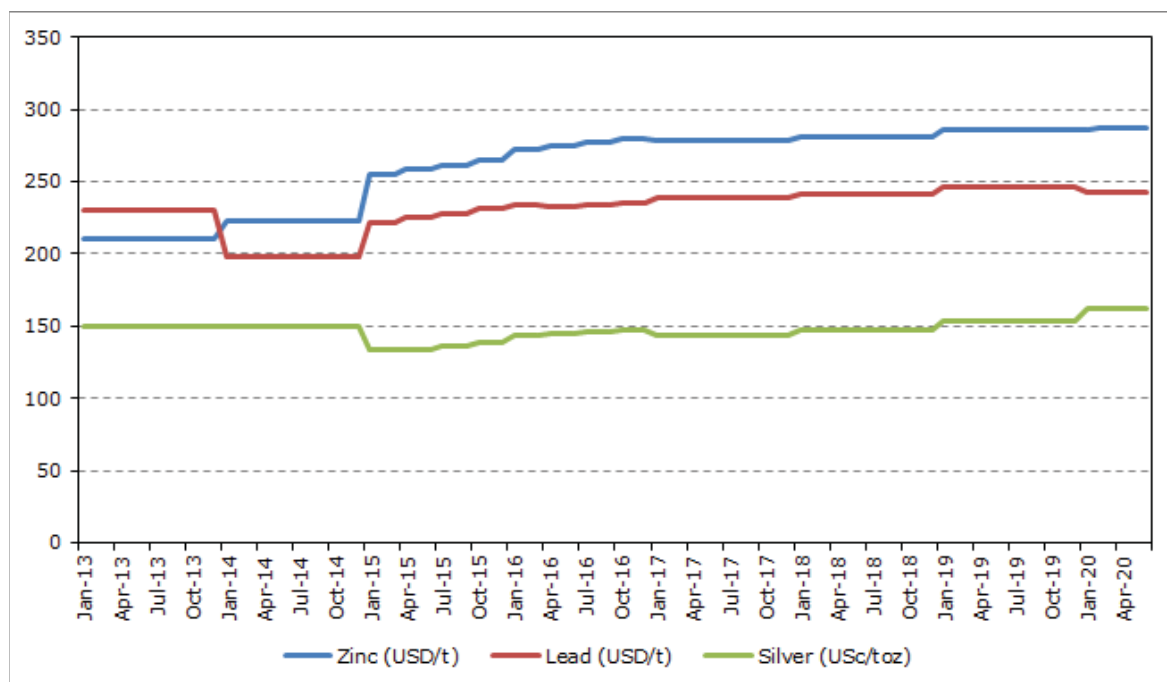

Source: Intierra, Xstract estimates

8 Valuation of Ore Reserves

8.1 Introduction

The valuation of Cannington Asset's Ore Reserves represents Xstract's overall judgement as to value. They do not rely on any one particular scenario or set of economic assumptions. The valuation has been determined having regard to the sensitivity of the discounted cash flow ("DCF") analysis to a range of technical and economic assumptions, as well as to the results of Xstract's comparable transaction analysis.

Given the requirement to value the Ore Reserves at a date as close as practical to the potential listing date, Xstract has adopted a valuation date of 31 December 2014. This has required some modifications to the stated Ore Reserves by depleting for actual production to 30 October 2014 and then forecasting production from 1 November to 31 December 2014.

8.2 Valuation methodology

This valuation has been prepared in accordance with the VALMIN Code, which classifies mineral assets according to their maturity. Under this Code, Cannington Operations is regarded as an operating mine.

Mineral assets are generally valued based on approaches that assess income, cost, and the open market. As the VALMIN Code is not prescriptive in this regard, the 2009 Edition of The South African Code for the Reporting of Mineral Asset Valuation ("SAMVAL") and the Canadian 2003 Edition of the Standards and Guidelines for Valuation of Mineral Properties ("CIMVAL") provide insight into applicable approaches, as shown in the table below.

Table 8.1: Valuation approaches for different types of mineral assets

Approach	Project development stage			
	Exploration	Resource	Development	Operating
Income	No	Rarely	Yes	Yes
Cost	Yes	Rarely	No	No
Market	Yes	Yes	Yes	Yes

Source: (CIMVAL 2003)

On this basis, Xstract considers the income-based approach to be the most appropriate for the valuation of Cannington Asset's Ore Reserves. The income-based approach is best suited for the valuation of individual assets for which a large amount of technical data has been collected or can be estimated. This approach involves the construction of a DCF model based on projected technical and economic inputs and includes sensitivity and scenario analysis.

Despite its sophistication, the income-based approach has limitations in that it:

- may not fully reflect the market value
- relies on a number of subjective inputs (e.g. the appropriate discount rate).

In addition, a valuer must also be cognisant of what the project is deemed to be worth by the market and actual transactions taking place, to ensure that the estimates derived by DCF analysis are realistic. As such, Xstract has reviewed recent transactions involving base metal assets of comparable standing to the Cannington Asset in order to validate the value derived by DCF analysis.

The effective date for this valuation is 31 December 2014.

8.3 Discounted cash flow

8.3.1 Key assumptions

Xstract has assessed the value the Cannington Asset using a DCF method. The cashflows use are those provided by BHPB Billiton in their LOA schedules, as modified by to account for Mineral Export Report specific requirements such as valuing only Ore Reserves.

The key valuation assumptions are as follows:

- Cash flow forecast is on an ungeared, all equity basis in real terms
- Consensus forecasts for silver, lead and zinc pricing
- Bloomberg-derived inflation forecasts until FY16 and exchange rate forecast to FY15. Going forward, exchange rates are determined from the forecast inflation differential between the US and Australia consumer price index ("CPI")
- Cash flow is escalated for depreciation and tax calculations
- A range of post-tax real discount rates between 8 and 12 per cent were applied
- NPV value was derived in USD from post-tax cash flows.

8.3.2 Production

Xstract has reviewed the production profile supplied by the Cannington Asset and has made certain modifications based on historical achievements and Xstract's opinion on the achievability of forecasts. Production achieved from Inferred Resources has also been excluded. The production profile considered for the financial valuation is shown in Table 8.2.

Table 8.2: Financial model production statistics

Operating Year (End June)		H2 FY2015	2016	2017	2018	2019	2020	2021	2022	2023
Parameter	Units									
Mill Feed	Mt dry	1.455	3.007	3.007	2.772	2.261	2.336	2.194	1.884	1.139
Head Grade	%									
Pb		6.66	6.41	6.42	6.49	6.46	6.22	6.21	5.77	5.85
Zn	%	3.28	3.77	4.02	4.25	4.46	4.17	4.10	4.07	3.29
Ag	ppm	270.69	245.67	248.89	228.85	238.00	241.74	234.51	202.14	208.36
Concentrates										
Pb	kt	124,247	252,468	252,744	235,022	190,735	189,825	178,855	142,794	87,545
Concentrate										
Pb Grade	%	68.4	67.3	67.2	67.5	67.5	67.4	67.0	66.8	66.8
Contained Pb	kt	84,985	169,911	169,844	158,640	128,746	127,942	119,833	95,386	58,480
Pb Recovery	%	87.7	88.1	88.0	88.2	88.2	88.1	87.9	87.7	87.7
Ag grade	g/t	2,755	2,558	2,584	2,383	2,468	2,612	2,521	2,339	2,396
Contained Ag	Moz	11.00	20.71	21.01	17.95	15.16	15.98	14.47	10.69	6.76
Ag Recovery	%	86.9	87.2	87.3	88.0	87.6	88.0	87.5	87.3	88.6
Zn	kt	73,488	176,380	187,587	186,755	157,812	154,219	141,333	120,241	59,343
Concentrate										
Zn Grade	%	48.6	48.6	48.6	48.6	48.6	48.6	48.6	48.6	48.6
Contained Zn	kt	35,715	85,721	91,167	90,763	76,697	74,951	68,688	58,437	28,841
Zn Recovery	%	74.9	75.6	75.4	77.1	76.1	77.0	76.4	76.2	76.9
Ag grade	g/t	166	130	124	105	106	114	113	98	124
Contained Ag	Moz	0.39	0.74	0.75	0.63	0.54	0.56	0.51	0.38	0.24
Ag Recovery	%	3.1	3.1	3.1	3.1	3.1	3.1	3.1	3.1	3.1

Source: Xstract estimates

8.3.3 Inflation and exchange rate

Based on Bloomberg data, Xstract has used Australian exchange rate forecast until FY15 and inflation forecasts until FY16. In order to forecast exchange rates going forward, Xstract has then escalated at the inflation differential between the two projected inflation rates (i.e. for Australian CPI relative to the US CPI) to determine the nominal exchange rate. The real exchange rate is constant at USD1:AUD0.85 as listed in Table 8.3.

Table 8.3: Inflation and exchange rate forecast

Description	2015	2016	2017
US CPI	1.9%	2.1%	2.1%
Australian CPI	2.6%	2.7%	2.7%
Inflation differential	0.9983	0.9936	0.9885
USD:AUD (nominal)	0.8500	0.8446	0.8402
USD:AUD (real)	0.8500	0.8500	0.8500

Source: Bloomberg, Xstract

8.3.4 Revenue

To forecast the revenue profile, Xstract has modified Cannington Asset's LOA model to account for only Ore Reserves as per specific Competent Persons Report requirements. On this basis, Xstract has forecast that Cannington Operations will produce 1.65 M dmt of lead concentrate and 1.26 M dmt zinc concentrate with credits for payable lead, zinc and silver over the life of the Ore Reserve. Most of the silver reports to the lead concentrate. Xstract forecast Cannington Asset will sell 128.4 Moz of silver, 1,064 kt of lead and 521 kt of zinc payable metal over its current LOA. Xstract has based its forecast on expected lead and zinc concentrate grades of 67.3 per cent and 48.6 per cent, respectively.

In determining appropriate prices to apply to Cannington Asset's forecast sales, Xstract has adopted metal price forecasts in nominal terms as published by Consensus Economics Inc. Xstract has projected the TC/RCs payable as a percentage based on historic data, as listed in Table 8.4.

Table 8.4: Forecast metal price, treatment charges and refining charges

Real prices	2015	2016	2017	2018	2019	2020
Lead (USD/t)	2,213	2,241	2,247	2,231	2,215	2,178
Zinc (USD/t)	2,311	2,363	2,400	2,358	2,344	2,322
Silver (USD/oz)	18.92	19.48	19.67	19.34	19.55	20.01
Lead conc. treatment charge (USD/t)	221	224	225	223	221	218
Zinc conc. treatment charge (USD/t)	254	260	264	259	258	255
Silver refining charge (USD/kg)	42.57	43.84	44.27	43.52	43.99	45.04

Source: Xstract estimates, Consensus Economics, October 2014

Lead concentrate customers are contracted to pay for 95 per cent of the lead and silver contained in concentrate valued at a price averaged over a quoted period. Deductions are included for treatment charges of the concentrate and refining charges for silver.

Zinc concentrate customers are contracted to pay 85 per cent of the zinc contained in concentrate valued at a price averaged over a quotation period. In addition, the customer will pay for 70 per cent of silver content in zinc concentrate, if it exceeds a threshold of 93 g/t.

Penalties and/or allowances are payable for fluorine, iron and magnesium oxide impurities that are outside a set range of thresholds in the concentrates. Xstract has assumed that deliveries will meet the quality specifications and therefore no penalties or allowances are expected to be paid by Cannington Asset.

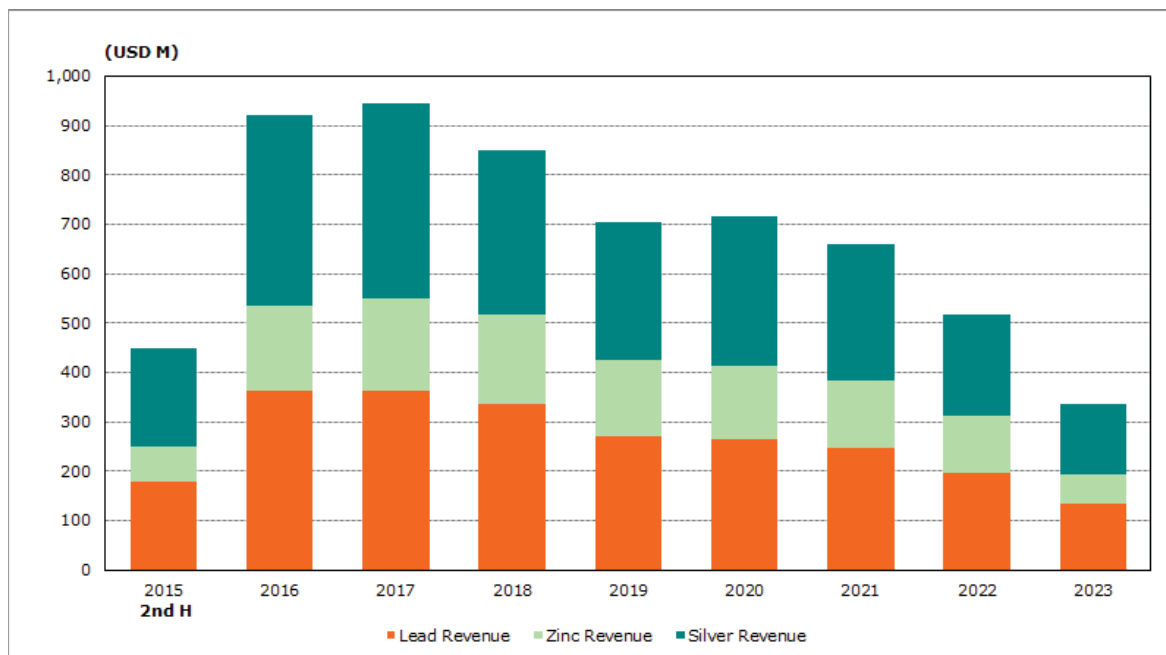
Figure 8.1: Revenue by payable metal (excluding TC/RC)

Source: Xstract estimates

8.3.5 Mining costs

Mining costs include development, production, ore handling, maintenance, labour, overheads and stope backfilling. Xstract has reviewed historic costs and its own internal database to verify projected costs are appropriate. The projected real cost over the remaining life is expected to average USD54/ROM wmt.

The largest portion of the mining cost is labour and other overheads at 55 per cent, while development and backfilling each constitute 12 per cent. There may be some opportunity in reducing labour and overhead costs.

Figure 8.2: Mining costs

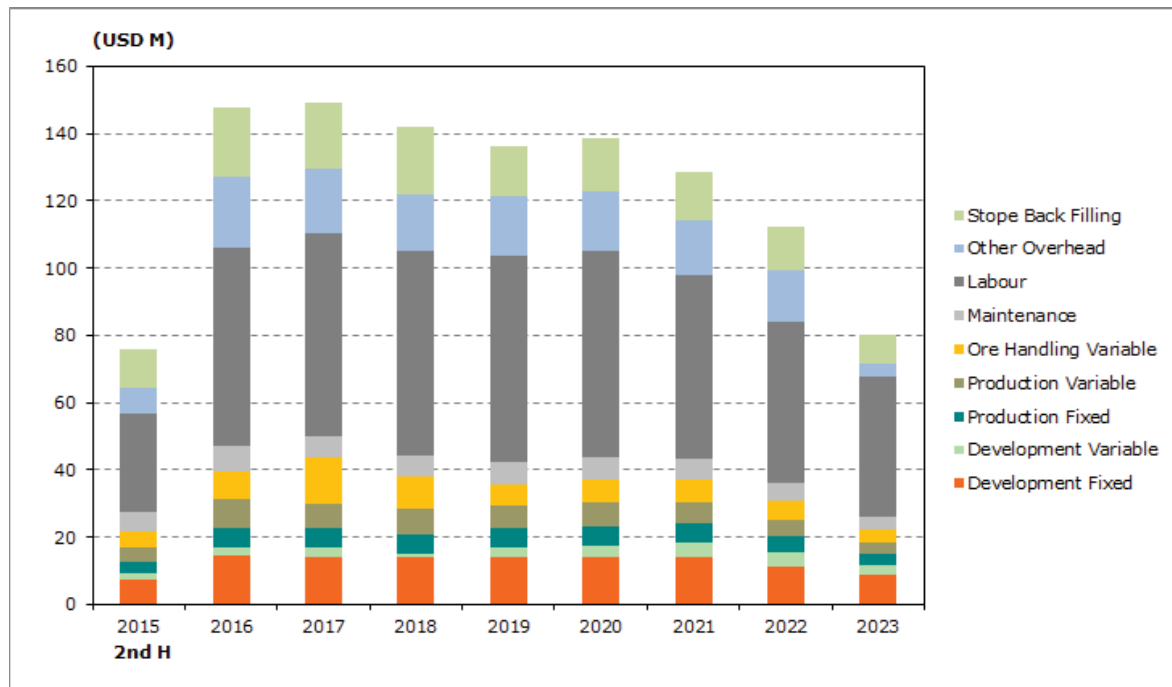

Source: Xstract estimates

8.3.6 Processing costs

Projected forecast processing costs have been compared against historic costs and compared against metrics implied by other comparable projects. Xstract expects Cannington Asset’s processing cost to average USD22/ROM wmt over the remaining life of Reserves.

8.3.7 Transportation and port handling costs

Road and rail transport costs are contracted to third parties. Xstract estimates an average domestic cost of USD0.14/wmt/km for road transport, while rail domestic costs average USD0.05/wmt/km over the forecast period.

BHPB Minerals own and operate the port. Port handling costs are forecast to average USD19/wmt.

Shipping costs of concentrate are forecast to average USD25/wmt of total concentrate produced.

8.3.8 Closure costs

The Cannington ML is planned for relinquishment in FY2034 to meet monitoring and reporting legislation. Current Ore Reserves are scheduled until 2023 for the underground operation. Provisions for annual closure costs are included as an operating cost and continue beyond the production life to 2036, reaching a total of AUD198 M (USD168 M).

These closure costs were estimated and outlined in the Cannington Asset’s Closure Plan, that is reviewed annually and updated every three years. The 2014 plan represents the most recent update. The Closure Plan includes costs associated with the rehabilitation and closure of the mine site and processing facilities, Yurbi rail loadout, Townsville port facility and redundancy costs. Cost also include post-closure management.

Xstract has reviewed the closure plan and considers the estimated closure costs to be reasonable. However, Xstract expects that there may be some opportunity to reduce this cost with the sale of the Townsville terminal and Yurbi train load-out facilities.

8.3.9 Total operating cost

Xstract estimates the total operating costs for the Cannington Operations to average USD136/wmt of ROM over the life of the Ore Reserves (Table 8.5).

Table 8.5: Operating cost summary

Item (USD/ROM wmt)	FY15 2 nd H	FY16	FY17	FY18	FY19	FY20 – 23 average
Mining	46.59	47.81	50.55	51.99	58.52	60.08
Processing	18.69	20.00	20.78	22.08	21.91	23.98
Transport	9.48	11.20	11.94	12.19	11.33	9.84
General and Administration	31.77	33.22	33.39	35.66	41.89	31.36
Shipping	3.94	4.04	4.41	4.46	3.95	3.31
Closure	-	0.03	0.01	0.01	0.01	8.47
Other (Marketing and Exploration)	2.85	2.72	1.62	1.23	1.23	0.97
Total	113.32	119.02	122.68	127.61	138.83	138.02

Source: Cannington Asset, Xstract estimate

Excluding closure costs, the largest cost component is for mining which accounts for some 44 per cent of operating cost. The next largest component is general and administration ("G&A") costs at 27 per cent. There may be some opportunity in reducing G&A costs.

Figure 8.3: Operating cost profile

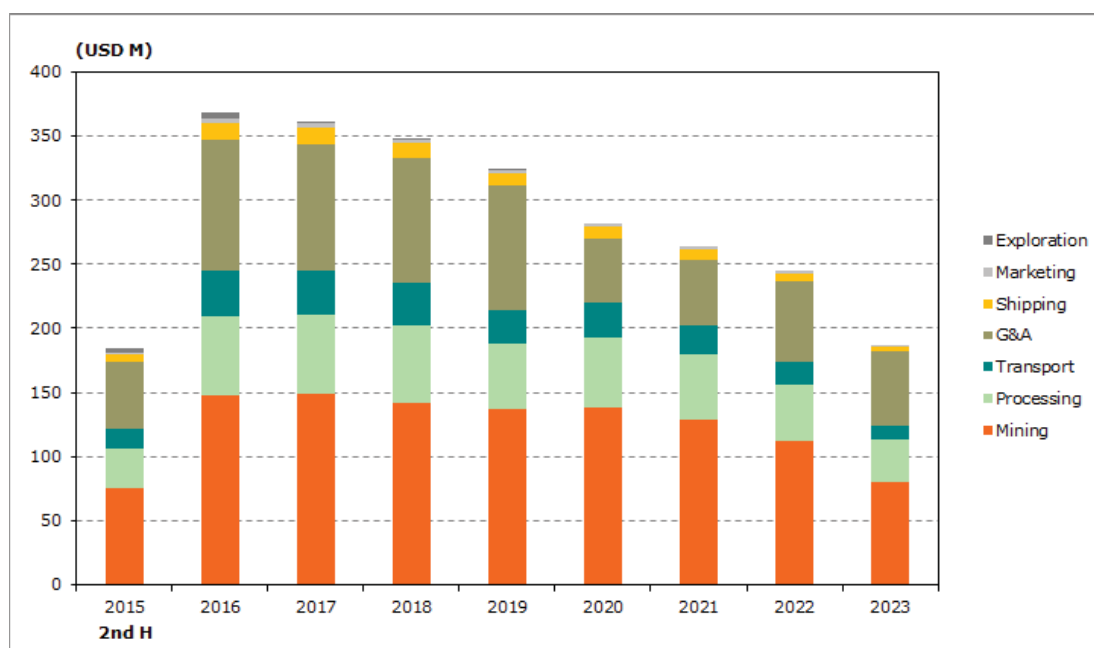

Source: Xstract estimates

8.3.10 Capital expenditure

Cannington Asset's sustaining capital expenditure over the remaining eight and half years of life in the operation amounts to USD378 M (real). This includes expenditure for underground mining equipment, capitalised mine development, processing, maintenance and other related assets, as listed in Table 8.6.

Table 8.6: Summary of sustaining capital expenditure

Item (USD M)	FY15 2 nd H	FY16	FY17	FY18	FY19	FY20 - beyond
Underground mining equipment	4.4	10.7	10.8	9.0	11.6	30.3
Mining Development	4.0	9.8	10.6	10.1	8.1	17.1
Crusher			10.2	35.7		
Maintenance and engineering	5.5	13.7	23.2	9.9	19.1	41.4
Processing	11.6	2.0	1.3	0.9	1.8	18.6
Other	2.7	5.7	5.9	9.4	8.4	14.0
Total	28.1	41.9	62.0	74.9	49.2	121.4

Source: Cannington Asset, Xstract estimate

The sustaining capital expenditure profile peaks at USD75 M (real) in 2018, with an average USD44 M per annum. Infrastructure maintenance and engineering makes up the largest portion from 2016 to 2019 to include moving an underground crusher. Annual expenditure then declines as production tails off in the last two years in 2022 and 2023. Xstract is confident that sufficient capital has been allocated over the life of Reserves based on its review of the mine plan.

8.3.11 Taxes and depreciation

In line with BHP Billiton protocol, a declining balance depreciation method has been used with a diminishing value multiplier of 200 per cent over the eight and a half year life of Reserves.

A corporate tax rate of 30 per cent has been applied to taxable income after depreciation.

Queensland State Government levies a royalty on free-on-board ("FOB") revenue at the port of Townsville before treatment and refining charges on payable metal. Variable rate of between 2.50 and 5.00 per cent (varying in 0.02 per cent increments), depending on average metal prices.

8.3.12 Net present value

The value of the Cannington Ore Reserves has been estimated using the DCF methodology, which estimates the market value of an asset by discounting the future free cash flows to their net present value, using an appropriate discount rate.

Our consideration of each of these factors is set out below.

Discount rate

A range of real discount rates, where applied to the projected USD free cash flow, between 8 and 12 per cent. This is an effective nominal discount range of 10.4 to 14.4 per cent.

To quantify the risk premium, Xstract has estimated South32's cost of equity using the capital asset pricing model ("CAPM") at approximately 9.7 per cent nominal or 7.4 per cent real (Table 8.7), assuming a listing in London. Given the all equity basis of this valuation, no debt has been assumed.

Table 8.7: Cost of equity (nominal)

Parameter	Value	Comment
Estimate of beta	1.55	Average beta of select comparable companies, data from Bloomberg
Market return	7.43%	S&P/ASX 300 Metals and Mining 10 years return
Risk free rate	3.27%	UK 10 year gilt yield
Risk premium	4.16%	Market return less risk free rate
Return on equity estimate	9.72%	Capital asset pricing model

Source: Bloomberg, FT.com, S&P Dow Jones Indices

This suggests that Xstract has applied a risk premium over the cost of equity between 0.6 and 4.6 per cent (nominal basis) to determine a NPV range for the Cannington Ore Reserves. Xstract considers the risk premium range to be appropriate given it must account for conventional underground mining, process technology, country and other associated risks.

The valuation date is 31 December 2014, with future free cash flows discounted back to this date.

Discounted net present value

Using a range of real discount rates, Xstract estimates the NPV of a 100 per cent interest in Cannington Asset's scheduled Ore Reserves of 19.9 Mt resides between USD964 M and USD1,021 M (Table 8.8).

Cannington Asset's free cash flow peaks at USD236 M (real) in 2016 before tailing off to the end of the operating life with declining production. An average operating cash flow margin of 49 per cent is achieved (Figure 8.4).

Table 8.8: Summary of the valuation of Cannington Asset's Ore Reserves on 100 per cent terms

Description	Unit	Value
Production Parameters		
Life of mine	years	8.5
Peak annual ROM production	dry Mt pa	3.00
Ore Reserves scheduled	dry Mt	19.9
Lead concentrate produced	dmt	1,654,234
Zinc concentrate produced	dmt	1,257,158
Payable lead	Mt	1.064
Payable zinc	Mt	0.521

Description	Unit	Value
Payable silver	M toz	128.40
Economic Parameters		
Average Price lead received	USD/t	2,212
Average Price zinc received	USD/t	2,346
Average Price silver received	USD/toz	19.65
Operating cost (excl. Royalty)	USD/ROM wmt	133
Operating cash flow margin	%	49
Capital cost	USD M	378
Net Present Value		
8% (real)	USD M	1,051.4
9% (real)	USD M	1,020.9
10% (real)	USD M	991.7
11% (real)	USD M	963.6
12% (real)	USD M	936.8

Source: Xstract estimates

Figure 8.4: Cash Flow of scheduled Ore Reserves

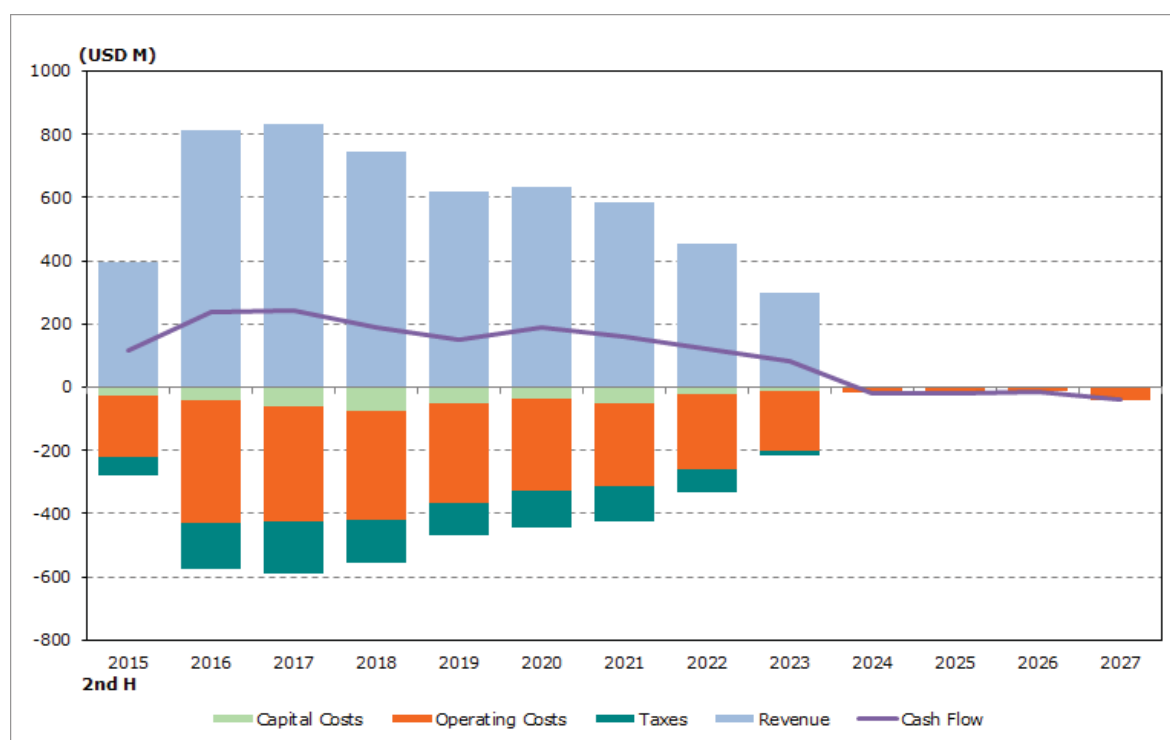

Source: Xstract estimates

8.3.13 Premium/discount to discounted cash flow value

The value assessed in Xstract's DCF analysis considers only the currently defined Ore Reserves at Cannington Operations. In determining whether the market would pay a premium or discount to the derived NPV, Xstract is cognisant of the following:

- In addition to the scheduled 19.9 Mt of Ore Reserves, there is an additional 6.9 Mt of Resources in the current mine plan. Given the requirement to value only Ore Reserves as part of this Competent Persons Report, these additional Resources were not valued.
- Optionality associated with the defined Mineral Resources outside of the current LOA mine plan.
- Given the high quality, low cost tonnes currently defined at Cannington Operations, Xstract considers these Resources would be highly attractive to the current market, even despite the current malaise and outlook towards commodity pricing.
- The strategic location of Cannington Operations relative to other world-class mining assets (i.e. Mount Isa, Ernest Henry, etc.) in the Mount Isa Inlier along with its proximity to established transport infrastructure is likely to hold significant appeal.
- Analysts suggest the recent market has been applying a discount to project NPV as measured by Price/Net Asset Value or NPV/share ratios. This suggests that analysts believe the market is not recognising and paying for project upside.

In light of these factors, Xstract expects the current market may pay little, if any, premium to the NPV of the defined Ore Reserves.

8.3.14 Sensitivity analysis

Figure 8.5 presents a sensitivity analysis of the input parameters to Xstract's DCF model. The NPV is most sensitive to metallurgical recoveries and exchange rate. A 10 per cent improvement in recoveries or depreciation in the exchange rate, improves the NPV by 23 per cent and 16 per cent, respectively.

NPV is equally sensitive to changes in the silver and lead pricing with an approximate improvement of 10 per cent in NPV, if these prices increase by 10 per cent. There is only a 4 per cent improvement in NPV, if the zinc price increases by 10 per cent.

A 13 per cent improvement in NPV occurs if a 10 per cent reduction in operating costs is achieved while only a 2 per cent improvement in NPV, if capital expenditure is reduced by 10 per cent.

Figure 8.5: Sensitivity of NPV

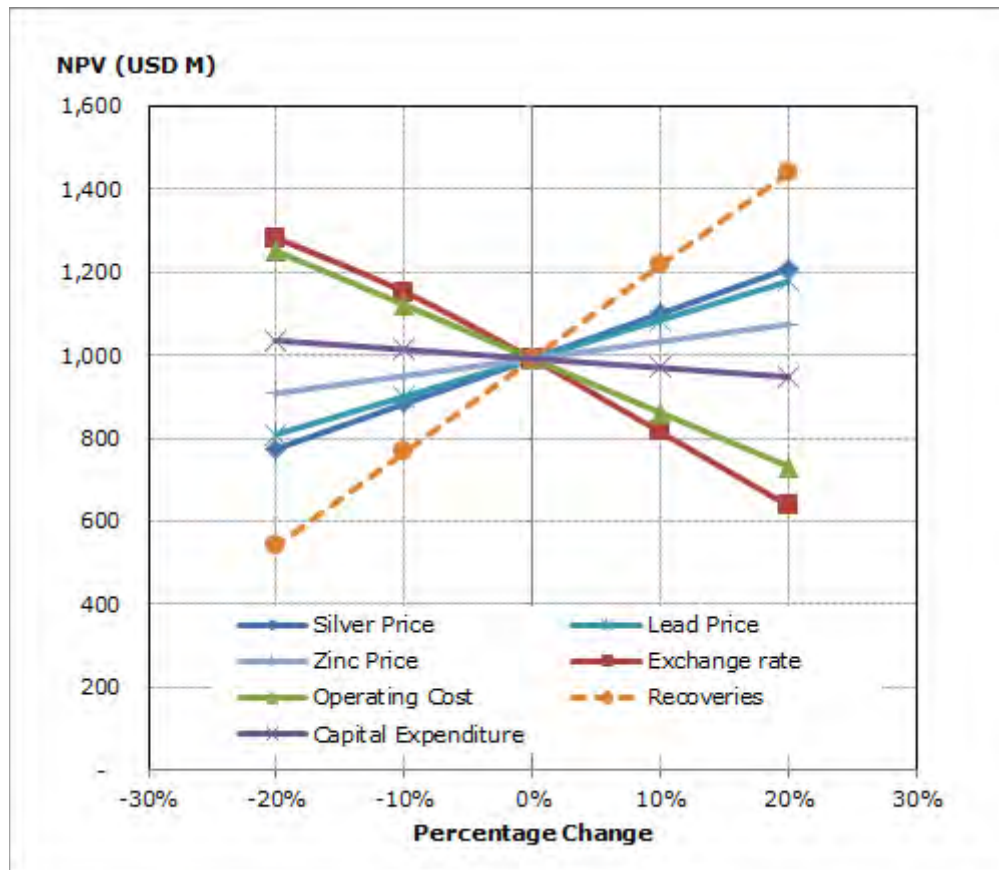

Source: Xstract estimates

8.4 Market support

8.4.1 Comparable market transactions

In order to validate the values derived by DCF analysis, Xstract has considered recent transactions involving similar quality assets to those at Cannington.

Xstract subscribes to the SNL and IntierraRMG ("Intierra") databases, which have been used for more than five years to obtain comparable transaction information. In Xstract's experience, the information provided on these databases is reliable and trustworthy.

During November 2014, Xstract reviewed transaction data relating to comparable silver-lead-zinc projects and mines, which had transpired since 2010. Xstract selected thirteen transactions from this search considered comparable. Analysis of the data resulted in a range of transaction values per equivalent silver ounce in Proved and Probable Reserves.

While evaluating these transactions, Xstract considered a metal ratio in order to compare transactions with more than one predominant metal or potential for future metal credits. The metal ratio considered by Xstract is similar to the calculation of metal equivalents, but assumes 100 per cent recovery for all relevant metals within the stated Ore Reserves, as accurate recovery data was not available in most cases. Xstract notes that it has not attempted to disclose JORC Code compliant Mineral Resources using metal equivalents in this report. Importantly, Xstract's implied value calculation is for the purposes of our valuation and does not attempt to estimate or reflect the metal tonnes likely to be recovered as required under the JORC Code. In our opinion, the above approach is

consistent with valuation methodology that would be adopted by potential purchasers under the fair market concept.

The implied values on a metal ratio basis (USD/toz Ag metal ratio) were calculated based on the stated base metal grades of the declared resources and the prevailing metal prices as at the time of the transaction. The USD/ toz Ag metal ratio value was then normalised by multiplying the silver price at the time of the transaction and dividing by the silver price at the current valuation date. Xstract notes that this method does not account for differences in recoveries of the various elements and implicitly assumes total recoverability. This effectively expresses all the transactions between 2010 and 2014 in the value of the silver price as at the valuation date.

The implied range extended from USD0.09/toz to USD4.82/toz Ag metal ratio, with an average of USD0.97/toz Ag metal ratio. These values are derived from the transaction shown in Table 8.9 and have been normalised to current market prices.

For Cannington Operations, the implied value of Xstract's DCF analysis equates to between USD2.70/toz and USD2.85/toz Ag metal ratio. This lies within, but at the upper end of, the range implied by recent market transactions.

While the transaction data supports the results derived from the DCF methodology, it is Xstract's opinion that the DCF modelling results provide a more conclusive indication of the market value of Cannington Asset's Ore Reserves.

Table 8.9: Comparable Market Transactions

Property Name	Buyer	Interest acquired	Announced Date	Country	Normalised Transaction Value (USD)	USD/MR
Black Mountain Lead/Zinc Mine	Vedanta Resources plc	74	10-May-10	South Africa	322,346,600	4.82
Coricancha Gold Mine	Nyrstar NV	15	07-Jul-10	Peru	4,233,396	2.05
Dapingzhang Copper/Zinc/Gold Mine	Grand Long Enterprises Ltd	40	27-Oct-10	China	46,204,645	1.22
Escobal Silver/Gold Mine	Tahoe Resources Inc.	100	03-May-10	Guatemala	501,221,014	1.11
Hellyer Zinc/Lead Project	Ivy Resources Pty Ltd	100	30-Jan-13	Australia	9,296,103	0.37
Jiama Copper/Gold/Silver Mine	China Gold Internat. Resources Corp. Ltd.	100	30-Aug-10	China	688,933,076	0.42
Lady Loretta Zinc/Lead/Silver Mine	Glencore Canada Corporation	25	03-Feb-11	Australia	16,957,545	0.19
Manuka Silver Mine	Southern Cross Goldfields Limited	100	05-Sep-14	Australia	5,049,542	0.40
Peelwood Copper/Zinc Project	CEB Resources Plc	49	17-Dec-13	Australia	936,906	0.81
Sulphur Springs Copper/Zinc Deposit	Venturex Resources Limited	100	21-Jan-11	Australia	15,629,760	0.21
Thalanga Base Metal Operation	Red River Resources Limited	100	03-Jul-14	Australia	4,971,471	0.39
Perkoa JV	Glancore Xstrata	27	16-Apr-14	Burkina Faso	10,435,549	0.53
Pulacayo-Paca Silver/Lead Mine	Porphary Coal Corp	100	04-Nov-14	Bolivia	3,654,075	0.09

Source: Intierra, Xstract estimate
MR – toz Ag metal ratio

8.4.2 Precedent transactions

Xstract is not aware of any precedent transactions involving the Cannington Ore Reserves.

8.4.3 Previous valuations

Xstract is not aware of any previous valuations of the Cannington Asset prepared in accordance with the VALMIN Code in the public domain.

8.5 Valuation summary

Based on the calculations described above, Xstract has assigned values for a 100 per cent interest in the Cannington Ore Reserves as summarised in Table 8.10.

Table 8.10: Assigned Value to the Cannington Ore Reserves

Project	Low (USD M)	High (USD M)	Preferred (USD M)
Cannington Ore Reserves (100%)	984	1,002	975

Source: Xstract estimates

This valuation is reflective of the Cannington Asset, based on our view in relation to the Ore Reserves only. It is important to emphasise that this value does not represent the value of the Ore Reserves in the ground in isolation, but rather, incorporates the value of all of ungeared net assets contributing to the Asset based on an Ore Reserves production profile. For example, at Cannington this includes the value of the use of processing facilities/truck fleet/rail loading facilities/rail entitlement/port infrastructure, as well as the mine.

9 Concluding remarks

From its independent review, Xstract considers that:

- Cannington Asset's management team has sufficient geological and geotechnical knowledge to support the Company's short-, medium- and long-term planning objectives and that the mining operations are well managed at an operating level.
- Xstract has some reservations regarding the viability and potential tonnages associated with some of the stated Mineral Resources, but the impact of a poor conversion to Ore Reserves is unlikely to have a material impact in the near term.
- Appropriate geological, geotechnical, operational and economic factors are considered in the mine planning process. In Xstract's opinion, the Ore Reserve estimate has been prepared in accordance with JORC Code guidelines. The mining extraction factors, as currently applied, possibly overstate the Ore Reserve grade but Xstract do not consider this to be material.
- Cannington Assets' mining equipment (either in place or as planned in capital estimates) is suited to the Company's proposed mine plans and is adequate, with minor adjustments for the production plans.
- Mineral processing plants and other infrastructure are capable of continuing to supply appropriate quality products to both domestic and export markets in line with the forecast production plans.
- Environmental issues are managed and there are no issues that could materially impede production, nor are any prosecutions pending.

- The assumptions used by Cannington Asset in estimating both capital and operating costs appear appropriate and reasonable.
- Capital and operating costs used in the financial models incorporating adjustments by Xstract reflect the requirements to mine plans, development and construction schedules and the forecast production levels.
- The mine plans and cost forecasts appropriately account for the risks identified. These risks are generally well understood by management and appropriate action to mitigate these risks is being taken.
- Management operates a management accounting system and are able to monitor and forecast production and cost parameters.

Xstract has estimated the value of a 100 per cent interest in the Cannington Ore Reserves as USD975 M assuming a real discount rate of 10 per cent, an exchange rate of AUD0.85/USD, and product prices, capital and operating costs and production forecasts, which are soundly based.

10 Consultant qualifications and experience

Jeames McKibben | General Manager & Principal Consultant | Corporate Advisory

During more than 20 years in the mining industry, Jeames has served in a diverse range of roles including corporate consultant, project manager, geologist and analyst. He has a strong record in project due diligence, independent technical review, valuation and deposit evaluation. Jeames has assisted numerous mineral companies and financial and legal institutions in securing regulatory approvals for IPOs and other secondary filings on a range of international exchanges. As a corporate consultant, he specialises in valuations and Competent Persons Reports for equity transactions and Independent Technical Reports in support of project finance. Other mandates include technical due diligence in support of information memoranda, divestments, acquisitions and mergers, pre-feasibility studies and independent Competent Persons' Reports. Jeames holds a Master of Business Administration and a Bachelor of Science with First Class Honours, is a Member of the Australian Institute of Geoscientists and a Chartered Professional Member of the Australasian Institute of Mining and Metallurgy. He is a current member of the VALMIN Code Review Committee.

Matthew Readford | Manager | Geology | Brisbane

Matthew has 27 years' experience in mining and management consulting. His mining experience ranges from resource estimation, feasibility and operational studies and independent expert reviews to business process and information technology system optimisation for a wide range of projects throughout the world. Commodity and mining settings include open pit and underground gold, copper, bauxite, base metals, coal, uranium, magnetite, iron ore and industrial minerals. Matthew's project locations include Australia, New Zealand, Fiji, Indonesia, Philippines, West and South Africa, Europe, the Middle East, Russia, Mongolia, North and South America. He has also worked in management consulting, operational, financial, safety and technology management roles in other industry sectors.

Matthew holds a Bachelor of Science with Honours in Structural Geology, a Masters of Business Administration, and is certified in Prince2 Project Management. He is a Member

and Chartered Professional of the Australasian Institute of Mining and Metallurgy ("AusIMM"), and Chair of the AusIMM South East Queensland Branch.

Tim Horsley | Associate Consultant | Mining

Tim has over 30 years' experience in the mining industry. This includes 18 years in operations in both production and technical roles, and 15 years in consulting. His experience covers a broad range of commodities, mining methods and countries covering all components of the mining industry value chain. Tim has project managed and provided technical input to numerous projects including feasibility studies, due diligence, valuation and mine optimisation. He has specific expertise in financial modelling, life of mine optimisation, pit to underground transition, ventilation and strategic planning. Tim has worked on projects in Africa, the Middle East, Europe, North America, South America, Australia and Asia.

Tim has a Bachelor of Science with Honours in Mining Engineering, is a Member of the Australasian Institute of Mining and Metallurgy and the Institute of Materials, Minerals & Mining. He is also a Chartered Engineer (UK).

Roland Nice | Associate Consultant | Processing

Rolly is a metallurgical engineer with over 45 years' experience. He has a strong track-record in mineral processing and metallurgy both in consulting and operational roles. He has previously been involved in due diligence activities and consulting to some of the world's largest poly metallic projects. He currently operates his own technical consulting firm, R.W.Nice and Associates. Rolly holds a BSc (Metallurgical Engineering) from Queen's University Canada, and is a member of the Australian Institute of Engineers and the Canadian Institute for Mining, Metallurgy and Petroleum and a fellow of the Australian Institute of Mining and Metallurgy.

Craig Miller | Associate Consultant | Environment

Dr Craig Miller operates his own environmental consultancy, CTM Consulting, providing leadership and technical expertise in Sustainability Science and Environmental Management. He has particular skills in the development of environmental management strategies to avoid, remedy or mitigate adverse impacts from development, as well as whole-of-system impact assessment, and the development of practical adaptation strategies for climate change and water security. His initial training and professional experience was in conservation ecology and management. He is working increasingly in the area of energy efficiency and greenhouse gas emission reduction, mitigation, and offsets. Craig has experience in Australia, New Zealand, Indonesia, the Philippines, and Vietnam, working with Government and research agencies, natural, agricultural and mineral resource-based industries, non-governmental organisations, and community groups. He has real-world experience on both sides of the development-protection agenda and is committed to identifying and developing environmentally, socially, and economically sustainable solutions.

Mathew Longworth | General Manager & Principal Consultant Xstract

Mathew is a geologist with over 25 years' experience across exploration, project evaluation/development, operations and corporate management. He previously held roles as Exploration Manager, COO and CEO/Managing Director with Australian listed companies, and as a mining analyst with a boutique investment fund. He has led multidisciplinary

project evaluation and development teams across a range of geological and geographic environments. Mathew has also been instrumental in the listing of a number of companies, in addition to acting as the link between corporate and technical advisors in fundraising and corporate transactions. He combines Board level experience with a strong technical and commercial background. Mathew holds a Bachelor of Science with Honours in Geology, and is a Member of the Australasian Institute of Mining and Metallurgy and the Australian Institute of Company Directors.

Donald Elder | Principal Consultant | Mining

Donald has over 20 years' experience in underground mining, mine planning, consulting, mineral resource management and project management. With considerable operational experience in South Africa and the Democratic Republic of the Congo, Donald has gained technical expertise in deep underground flat alluvial gold deposits as well as deep level multiple reef packages, hard rock mining methods for narrow vein and massive ore bodies, underground mine infrastructure design and planning, mine production scheduling and financial evaluation. In addition to his operational experience, Donald has several years of experience in the management of technical teams and technical studies.

Donald holds a National Higher Diploma in Mineral Resource Management, a Graduate Diploma of Engineering in Mining Engineering, and is a Member of the Australasian Institute of Mining and Metallurgy.

Richard Price | Principal Consultant | Corporate Advisory

Richard is a mining engineer with ten years of mining experience and nearly four years of investment banking experience. He worked in a number of mine production roles while at University, and then as a graduate engineer in a gold mine. Richard spent several years with a mining equipment company before working for over three years in consulting, and has also worked in business improvement roles onsite with BHP Billiton (Olympic Dam) and Rio Tinto (Iron Ore). Following the completion of a Masters in Mineral Economics, Richard worked for Standard Chartered Bank in Perth, London and Singapore. He also has experience with a boutique corporate advisory firm in Australia. Richard's financing experience covers both equity and debt capital raising and financial markets products.

Richard holds a Bachelor of Engineering with Honours in Mining and is a Member of the Australasian Institute of Mining and Metallurgy.

Shaun Barry | Associate Consultant | Corporate Advisory

Shaun has a commercial and geological background with over 20 years of experience in sales, marketing, commodity analysis, equity analysis, strategy development, and geology gained in platinum group metals, gold, coal, base metals, bauxite, and alumina. As a corporate consultant, he specialises in mineral asset valuations, market reviews of mineral commodities, and country reviews. Shaun also specialises in corporate strategy development that supports the preparation of Competent Persons Reports for equity transactions and Independent Technical Reports for project finance and mineral asset valuations. Shaun holds a Master of Science in Mineral Economics, a Bachelor of Science with Honours in Geology and a Diploma in Investment Management. He is a Member of the Australasian Institute of Mining and Metallurgy.

11 References

- AARC, 2008, "Cannington Life Extension, Initial Advice Statement" Prepared for BHP Billiton Minerals Pty Limited, dated May 2008.
- Bailey, A, 1998, "Cannington silver-lead-zinc deposits", in *Geology of Australian and Papua New Guinea Mineral Deposits*, (Eds D A Berkman and D H Mackenzie), pp 783 – 792 (the Australasian Institute of Mining and Metallurgy: Melbourne).
- Bailey, A and Thomas, M.J., 1993, "The Cannington Deposit – Its Discovery, Geology and Evaluation", Carpentaria and Mount Isa Regional Development Forum, North West Queensland Branch of the Australasian Institute of Mining and Metallurgy, Mount Isa, 2 August 1993.
- BHPB Cannington, 2014, "Copper – Cannington Mine Competent Person Report for Cannington Mine as at 30 June 2014"
- BHPB Cannington, 2014, "LoA16 Appraisal Day One_final_submitted 20140923" presentation October 2014.
- BHPB Cannington, 2014, "LoA16 Appraisal Day Two_final_submitted 20140930" presentation, October 2014.
- BHPB Cannington, 2014, "Cannington UG mobile equipment - Nov 2014" spread sheet, October 2014.
- BHPB Cannington, 2014, "CAN-MINING-Haul truck Operations Manual-2064" spread sheet, November 2014.
- BHPB Cannington, 2014, "BM-CANN-CONTRACT-07 2013" pdf document Orica goods and services contract, November 2014.
- BHPB Cannington, 2014, "Production depletion and forecast for remainder of CY14 updated" spread sheet, November 2014.
- BHPB Cannington, 2014, Assorted monthly production presentations, October 2014.
- BHPB Cannington, 2014, Pebble Crusher Circuit Upgrade Study Work Plan, January 2014.
- BHPB Cannington, 2014, Mill physicals 2009 to 2014, BHPB excel spreadsheet, November 2014.
- BHPB Cannington, 2014, TSV-Fin-Wksht-Atlas FY 2016 LoA OBP Model-2014 10 14 – Public, BHPB excel spreadsheet, November 2014.
- BHPB Cannington, 2014, Life of Asset Model 01 January 2015,, November 2014.
- BHPB Cannington, 2014, Plant equipment list - Row 11. Processing Equipment List, Signet Engineers excel spreadsheet, November 2014.
- BHPB Cannington, 2014, Opportunity Assessment Plan – Cannington, BHPB, July 2014.
- BHPB Cannington, 2014, Paste Plant Expansion - End of Phase Study Report Rev F, June 2014.
- BHPB Cannington, 2014, Cannington Operations – Closure Plan, Internal BHP report, 2014
- BHPB Cannington, 2013, Appendix C-1 Cannington Plan of Operations March 2013 (Cell 3) 4Apr13-30Apr16_rev1.5., March 2013.
- BHPB Cannington, 2013, Weighted average Recovery OBP Processing, BHPB excel workbook, July 2013.
- BHPB Cannington, undated, Talc Pre-Float, internal memoranda.

- BHPB Cannington, undated, Appendix 11 - Metallurgical Process Flow Diagram.
- Blake, D.H., undated, "Geology of the Mount Isa Inlier and environs, Queensland and Northern Territory", Bureau of Mineral Resources Bulletin 225.
- CRSM, 2008, "Community Perceptions Study for BHP Billiton Cannington Mine", report prepared by Centre for Social Responsibility in Mining, The University of Queensland.
- Department of Environment and Resource Management, 2011, "Environmental Impact Statement (EIS) Report under the Environmental Protection Act, 1994 Cannington Life Extension Project, Proposed by BHP Billiton Mineral Pty Ltd, December 2011".
- European Securities and Market Authority, 2013, "ESMA update of the CESR recommendations. The Consistent implementation of Commission Regulation (EC) No. 809/2004 implementing the Prospectus Directive", ESMA/2013/319, 20 March 2013.
- Golder Associates, 2011, "Cannington Ag-Pb-Zn Mine 2011 Resource Audit", External Audit (unpublished).
- Hatch, 2005, "BHPB Cannington data management – quality assurance data assessment 2005", Draft report 00478-0000-MG-24-0001 (10th June Rev. B, unpublished).
- Hatton, O.J., 2004, "Sedimentology, Geochemistry, Volcanology and Basin Evolution of the Soldiers Cap Group, Eastern Succession, Mt Isa Inlier, Northwest Queensland, Australia", PhD Thesis, Centre for Ore Deposit Research, University of Tasmania, April 2004.
- hrltesting Pty Ltd, 2013, "Metallurgical Testwork – BHP Cannington Heavy Media Separation" Internal Report for BHP Billiton Cannington, May 2013.
- JKTech, 2014, "Flash Flotation Tail - Testing and Simulation" Internal report to BHP Billiton Cannington, July 2014.
- JORC, "Australasian Code for the Reporting of Exploration Results, Mineral Resources and Ore Reserves", 2012 Edition, prepared by *the Joint Ore Reserves Committee of The Australasian Institute of Mining and Metallurgy, Australian Institute of Geoscientists and Minerals Council of Australia*.
- Leung, K., et al, 2000, "Commissioning the Cannington Project – Creating Success", AusIMM Seventh Mill Operators Conference, October 2000.
- Mark, G, 1993, "Pegmatites and partial melting at the Cannington Ag-Pb-Zn deposit.", BSc. Honours thesis (unpublished), James Cook University of North Queensland, Townsville.
- McGrath, C, 2011, "Synopsis of the Queensland Environmental Legal System", 5th Edition.
- McNamara, N, 2009, "The environmental regulation of mining: an international comparison", PhD Thesis, University of Southern Queensland.
- Okely, A., et al, 2004, "Cannington Growth Project, A Partnering Approach to Design and Implementation", MetPlant Conference, 2004, 06-07 July 2004.
- Queensland Department of Mines and Energy, 2006; Queensland Mining 2006 Update; Mining and petroleum statistics, projects and industry trends, November, 2006.
- Roche, M.T., 1994, "The Cannington Silver Lead Zinc Deposit – at Feasibility", The AusIMM Annual Conference, Darwin, 5 – 9 August 1994.
- Rossiter, A, 1998, "Cannington Mine Development Project 1993 -1998", AusIMM '98 – The Mining Cycle, Mount Isa, 19 – 23 April 1998.

SAMVAL. "The South African Code for the Reporting of Mineral Asset Valuation" *The Southern African Institute of Mining and Metallurgy and the Geological Society of South Africa*. 2008 Edition, prepared by the South African Mineral Asset Valuation (SAMVAL) Working Group.

VALMIN. "Code for the Technical Assessment and Valuation of Mineral and Petroleum Assets and Securities for Independent Expert Reports." 2005 Edition, prepared by *The Australasian Institute of Mining and Metallurgy, the Australian Institute of Geoscientists and Mineral Industry Consultants Association*.

Appendix A: ESMA/CESR Compliance Checklist



ESMA/CESR Compliance Summary

ESMA/CESR Item	ESMA/CESR Contents	Report Item
131 (a)	Is the asset a material mineral project?	2.1; 3.3; 4.1; 5.1
131 (b)	Types of mineral projects – exploration, development, planning or production? Key products – processed ores (concentrates and tailings) and solid fuels (coal and peat)	2.1; 2.2; 4.4.2 2.7; 4.1; 4.9.1
131 (c)	Uncertainty as to the quantities of economically recoverable resources or technical feasibility of their recovery Uncertainty as to either the existence of the resources in the quantities required or the technical feasibility of their recovery	2.10; 4.7; 4.19 2.10; 4.7; 4.19
132 (a)	Details of Mineral Resources, and where applicable Ore Reserves (presented separately) and exploration results/prospects in accordance with one of more of the reporting standards that is acceptable under the codes and/or organisations set out in Appendix 1 (e.g. JORC/SAMREC and VALMIN/SAMVAL).	4.7; 5.0
132 (b)	Anticipated mine life and exploration potential or similar duration of commercial activities in extracting Ore Reserves	4.1.2; 4.7.2; 4.8.4; 8.3.2; 8.3.1211
132 (c)	An indication of duration and main terms of any licences or concessions and legal, economic and environmental conditions for exploring and developing those licences or concessions	4.4.1 to 4.4.8
132 (d)	An indication of the current and anticipated progress of mineral exploration and/or extraction and processing including a discussion of the accessibility of the deposit.	4.19; 5.1 to 5.6
132 (e)	An explanation of any exceptional factors that have influenced (a) to (d) above.	4.1.2; 4.19; 6.0
133 (i)(a)	Be prepared by an individual who: Either: Possesses the required competency requirements as prescribed by the relevant codes/organisation (listed in Appendix 1); or If such requirements are not prescribed by the code/organisation, then Is professionally qualified and a member in good standing of an appropriate recognised professional association, institution or body relevant to the activity being undertaken and who is subject to the enforceable rules of conduct Has at least five years' relevant professional experience in the estimation, assessment and evaluation of the type of mineral or fluid deposit being or to be exploited by the company and to the activity to which that person is undertaking; and Is independent of the company, its directors, senior management and its other advisers; has no economic or beneficial interest (present or contingent) in the company or in any of the mineral assets being evaluated and is not remunerated by way of a fee that is linked to the admission or value of the issuer	3.6 to 3.8

ESMA/CESR Item	ESMA/CESR Contents	Report Item
133 (i)(b)	Be dated not more than 6 months from the date of the prospectus provided the issuer affirms in the prospectus that no material changes have occurred since the date of the competent person's report the omission of which would make the competent person's report misleading	2.0
133 (i)(c)	Report mineral resources and where applicable reserves and exploration results/prospects in accordance with one or more of the reporting standards that is acceptable under the codes and/or organisations set out in Appendix I (Mining Reporting)	2.3; 2.4; 4.7
133 (i)(d)	Contain information on the company's mineral projects segmented using a unit of account appropriate to the scale of its operations and prepared, in the case of a company with mining projects, having regard to Appendix II.	4.0; 5.0
133 (ii)	An issuer is exempt from including the Competent Person's report, if the issuer can demonstrate that: Its equity securities are already admitted to trading on either a regulated market, an equivalent third country market, or an appropriate multi-lateral trading facility; and It has reported and published annually details of its mineral resources and where applicable reserves (presented separately) and exploration results/prospects in accordance with one or more of the reporting standards set out in Appendix I for at least three years.	N/A
133 (iii)	Information on mineral resources and where applicable reserves and exploration results/prospects as well as other information of a scientific or technical nature included in prospectuses outside of the competent person's report must not be inconsistent with the information contained in the competent person's report.	CONFIRMED
133 (iv)	Information required by any of these recommendations may be omitted if disclosure is prohibited by third country securities laws or regulations provided the issuer identifies the information omitted and law/regulations that prohibit disclosure.	4.4.8
157	When analysing whether an expert, who has produced a report included in the prospectus, has a material interest in the issuer, issuers are normally expected to consider the following circumstances related to the expert, among others: - ownership of securities issued by the issuer or by any company belonging to the same group or options to acquire or subscribe for securities of the issuer; - former employment of the issuer or any form of compensation from the issuer; - membership of any of the issuer's bodies; - any connections to the financial intermediaries involved in the offering or listing of the securities of the issuer.	3.6 to 3.8
Appendix II (i)	Legal and Geological overview – a description of: the nature and extent of the company's rights of exploration and extraction and a description of the properties to which the rights attach, with details of the duration and other principal terms and conditions of these rights including environmental obligations, and any necessary licences and consents including planning permission any other material terms and conditions of exploration and extraction including host government rights and arrangements with partner companies	4.4.1 to 4.4.8 N/A
Appendix II (ii)	Geological Overview – a description of the geological characteristics of the properties, the type of deposit, its physical characteristics, style	4.6

ESMA/CESR Item	ESMA/CESR Contents	Report Item
	of mineralisation, including a discussion of any material geotechnical, hydro-geological/hydrological and geotechnical engineering issues	
Appendix II (iii)	Resources and reserves	
	a table providing data on (to the extent applicable): exploration results inclusive of commentary on the quantity and quality of this, inferred, indicated/measured resources, and proved/probable reserves and a statement regarding the internationally recognised reporting standard used;	4.7; 5.0
	description of the process followed by the competent person in arriving at the published statements and a statement indicating whether the competent person has audited and reproduced the statements, what additional modifications have been included, or whether the authors have re-verted to a fundamental re-calculation	3.2; 4.7
	statement as to whether mineral resources are reported inclusive or exclusive of reserves	4.7.1
	supporting assumptions used in ensuring that mineral resource statements are deemed to be 'potentially economically mineable	4.7.1
	supporting assumptions including commodity prices, operating cost assumptions and other modifying factors used to derive reserve statements	4.7.2; 4.8 to 4.19
	reconciliations between the proposed and last historic statement	4.5; 4.7.1; 4.7.2
	a statement of when and for how long a competent person last visited the properties (or a statement that no visit has been made if that is the case)	3.2
	for proved and probable reserves (if any) a discussion of the assumed:	
	mining method, metallurgical processes and production forecast	4.8 to 4.10
	markets for the company's production and commodity price forecasts	4.16; 7.0; 7.4
	mine life	4.1.2; 4.7.2; 4.8.4
	capital and operating cost estimates	4.18
Appendix II (iv)	Valuation of reserves – taking consideration of internationally recognised valuation codes as set out in Appendix I a valuation of reserves comprising:	8.2
	an estimate of net present value (or a valuation arrived at on an alternative basis, with an explanation of the basis and of the reasons for adopting it) of reserves	8.3
	the principal assumptions on which the valuation of proved and probable reserves is based including those relating to discount factors, commodity prices, exchange rates, realised prices, local fiscal terms and other key economic parameters	8.3
	information to demonstrate the sensitivity to changes in the principal assumptions; or a statement that the valuation of reserves is omitted)	8.3.13
Appendix II (v)	Environmental, Social and Facilities – an assessment of	
	environmental closure liabilities inclusive of biophysical and social aspects, including (if appropriate) specific assumptions regarding sale of equipment and/or recovery of commodities on closure, separately identified	4.17.8; 4.18; 8.3.8

ESMA/CESR Item	ESMA/CESR Contents	Report Item
	environmental permits and their status including where areas of material non-compliance occur	4.17.4/5
	commentary on facilities which are of material significance	4.17.6
Appendix II (vi)	Historic Production/Expenditures – an appropriate selection of historic production statistics and operating expenditures over a minimum of a three year period	2.10, 4.8.3
Appendix II (vii)	Infrastructure – a discussion of location and accessibility of the properties, availability of power, water, tailings storage facilities, human resources, occupational health and safety	4.9.4 to 4.12; 4.13; 4.14;
Appendix II (viii)	Maps etc. – maps, plans and diagrams showing material details featured in the text; and	Various
Appendix II (ix)	Special factors – if applicable a statement setting out any additional information required for a proper appraisal of any special factors affecting the exploration or extraction businesses of the company (for example in the polar regions where seasonality is a special factor).	6.0

Appendix B: JORC 2012 Table 1

JORC Code, 2012 Edition – Table 1 report template

Section 1: Sampling Techniques and Data

Criteria	JORC Code explanation	Commentary
Sampling techniques	<ul style="list-style-type: none"> Nature and quality of sampling (e.g. cut channels, random chips, or specific specialised industry standard measurement tools appropriate to the minerals under investigation, such as down hole gamma sondes, or handheld XRF instruments, etc). These examples should not be taken as limiting the broad meaning of sampling. Include reference to measures taken to ensure sample representivity and the appropriate calibration of any measurement tools or systems used. Aspects of the determination of mineralisation that are Material to the Public Report. In cases where 'industry standard' work has been done this would be relatively simple (e.g. 'reverse circulation drilling was used to obtain 1 m samples from which 3 kg was pulverised to produce a 30 g charge for fire assay'). In other cases more explanation may be required, such as where there is coarse gold that has inherent sampling problems. Unusual commodities or mineralisation types (e.g. submarine nodules) may warrant disclosure of detailed information. 	<ul style="list-style-type: none"> One metre half core samples are crushed to a nominal 2mm of which 300 grams is pulverized to a 90% pass at 75 micron. A 50 gram sample is then digested and presented for ICP-OES assay. Field sampling protocols to ensure sample representivity are followed and documented. Field sampling procedures are stored electronically in the Cannington document management system and are easily assessable by Cannington geological and core shed personnel.
Drilling techniques	<ul style="list-style-type: none"> Drill type (e.g. core, reverse circulation, open-hole hammer, rotary air blast, auger, Bangka, sonic, etc.) and details (e.g. core diameter, triple or standard tube, depth of diamond tails, face-sampling bit or other type, whether core is oriented and if so, by what method, etc). 	<ul style="list-style-type: none"> The bulk of the data used for the Resource estimation is based on logging and sampling of LtK60 and NQ diamond drill cores collared from underground excavations (80% of the 6,975 drillholes). Surface drilling is generally by RC drilling through the Cretaceous cover sequence with HQ size diamond drilling 'tails' through the Proterozoic host rocks (16% of the data). The remaining 4% of the data has been obtained from Percussion and RC drilling from surface.

Criteria	JORC Code explanation	Commentary
Drill sample recovery	<ul style="list-style-type: none"> Method of recording and assessing core and chip sample recoveries and results assessed. Measures taken to maximise sample recovery and ensure representative nature of the samples. Whether a relationship exists between sample recovery and grade and whether sample bias may have occurred due to preferential loss/gain of fine/coarse material. 	<ul style="list-style-type: none"> 64 underground and 420 surface drillholes have been orientated using a variety of methods from downhole spear, Ballmark, Ezy-Mark since drilling began in 1990. Drill core recovery is measured per run length and recorded at the underground drill rig site. Core recovery averages 98% across the Cannington orebody. Poor core recovery is often experienced when drilling through the Trepell and Hamilton Fault zones. No mineralization exists within these fault zones.
Logging	<ul style="list-style-type: none"> Whether core and chip samples have been geologically and geotechnically logged to a level of detail to support appropriate Mineral Resource estimation, mining studies and metallurgical studies. Whether logging is qualitative or quantitative in nature. Core (or costean, channel, etc) photography. The total length and percentage of the relevant intersections logged. 	<ul style="list-style-type: none"> Diamond drill core geological logs consist of lithology, mineralization, structure, alteration, Min_Type, and RQD. Drill core samples through mineralisation are marked up at 1m intervals with an additional 6m into unmineralised material at either end of the mineralised zone. The entire length of the drill core is geologically logged and photographed. Drillholes designed specifically for geotechnical information are geotechnically logged by geotechnical specialists.
Sub-sampling techniques and sample preparation	<ul style="list-style-type: none"> If core, whether cut or sawn and whether quarter, half or all core taken. If non-core, whether riffled, tube sampled, rotary split, etc and whether sampled wet or dry. For all sample types, the nature, quality and appropriateness of the sample preparation technique. Quality control procedures adopted for all sub-sampling stages to maximise representivity of samples. Measures taken to ensure that the sampling is representative of the in situ material collected, including for instance results for field duplicate/second-half sampling. 	<ul style="list-style-type: none"> One metre drill core samples are sawn using automatic core saws to obtain half core samples. Quarter core field duplicates for Silver, Lead and Zinc are submitted at a rate of 1:10 samples. Approximately 3,700 quarter core field duplicate samples have been submitted during the period January 2005 and December 2011, with 641 field duplicates submitted in 2011 calendar year. Although within acceptable range for resource modelling purposes, results of historic field duplicate sampling of LTK60 and NQ core size, suggests that quarter core may not have been appropriate in areas of the deposit where large galena crystal existed. As the deposit is maturing and mineralisation is becoming more disseminated, it is

Criteria	JORC Code explanation	Commentary
	<ul style="list-style-type: none">Whether sample sizes are appropriate to the grain size of the material being sampled.	expected that the precision of future field duplicate results will improve.

Criteria	JORC Code explanation	Commentary
Quality of assay data and laboratory tests	<ul style="list-style-type: none"> The nature, quality and appropriateness of the assaying and laboratory procedures used and whether the technique is considered partial or total. For geophysical tools, spectrometers, handheld XRF instruments, etc, the parameters used in determining the analysis including instrument make and model, reading times, calibrations factors applied and their derivation, etc. Nature of quality control procedures adopted (e.g. standards, blanks, duplicates, external laboratory checks) and whether acceptable levels of accuracy (i.e. lack of bias) and precision have been established. 	<ul style="list-style-type: none"> Cannington drillcore samples are digested in acid and then analysed by ICP-OES instrumentation. Digestion is near total dissolution and is specifically formulated to retain low-solubility elements such as Pb and Ag in solution at higher concentrations. The Cannington laboratory QAQC includes coarse and pulp duplicates at a rate of 1:10 samples. Pulp duplicates are analysed using Atomic Absorption Spectroscopy (Silver only) or by X-ray Fluorescence Spectrometry (Lead and Zinc). Coarse duplicate results outside of 20% tolerance and pulp duplicate results outside 10% tolerances are checked and the batch reassayed if required. During the period January 2003 to January 2012, eight matrix-matched Cannington ore standards representing the range in Silver grades were submitted at an average rate of one standard per underground drillhole. Standard return results for Silver show good precision and accuracy across all grade ranges however results suggest a low bias for low Ag grades and a high bias for high Ag grades from approximately 2008 to January 2012. Current investigations, using three different analytical methods as well as an external laboratory, indicate that the 'expected values' for the standards are incorrect and the 'true values' fit the mean value of the results. This therefore suggests that a bias does not exist. Four new matrix-matched certified standards to replace the existing standards are correctly being sourced. Laboratory QAQC measures at the Cannington laboratory include two geological standards (prepared and certified by Gannet Holdings Pty Ltd) made of homogenized Cannington ore representing the range of resource grades. Standard calibrations using a Certified Reference Material (CRM) - OREAS 32 Base Metal sulphide were also undertaken. The Cannington laboratory submits 1:100 pulp samples to an external laboratory (Bureau Veritas - Amdel Adelaide) for check assay. No material issues have been reported with check assay results to January 2012.

Criteria	JORC Code explanation	Commentary
Verification of sampling and assaying	<ul style="list-style-type: none"> The verification of significant intersections by either independent or alternative company personnel. The use of twinned holes. Documentation of primary data, data entry procedures, data verification, data storage (physical and electronic) protocols. Discuss any adjustment to assay data. 	<ul style="list-style-type: none"> Mineralised intersections are verified by mine geologists throughout each drilling programme. Seven twinned RC drillholes were completed during the North Zone open pit area drilling programme of 74 RC drillholes. No twinning of underground drillholes has been completed. Documentation, procedures and protocols are stored electronically in the BHP Billiton - Cannington document management system. No adjustment to assay data has been undertaken.
Location of data points	<ul style="list-style-type: none"> Accuracy and quality of surveys used to locate drill holes (collar and down-hole surveys), trenches, mine workings and other locations used in Mineral Resource estimation. Specification of the grid system used. Quality and adequacy of topographic control. 	<ul style="list-style-type: none"> Drillholes collar locations are surveyed by Cannington surveyors using Leica Total Station upon completion of each drill fan. Downhole surveys are completed using a Maxibor downhole or Eastman camera surveys. Since 2009, a Reflex Gyroscopic tool 'GyroSmart' has been predominantly used for downhole surveys. Drillholes with missing collar or downhole survey data are checked and excluded from the resource if they cannot be verified.
Data spacing and distribution	<ul style="list-style-type: none"> Data spacing for reporting of Exploration Results. Whether the data spacing and distribution is sufficient to establish the degree of geological and grade continuity appropriate for the Mineral Resource and Ore Reserve estimation procedure(s) and classifications applied. Whether sample compositing has been applied. 	<ul style="list-style-type: none"> Underground diamond drilling is conducted on 12.5m spaced sections along strike (north-south mine grid). Drill fans are designed to obtain approximate east-west mine grid and vertical spacing of 12.5m to 15m. This section spacing is sufficient to establish the degree of geological and grade continuity necessary to support the reported Resource classifications. Drilling is composited using a 2m sample interval.
Orientation of data in relation to geological structure	<ul style="list-style-type: none"> Whether the orientation of sampling achieves unbiased sampling of possible structures and the extent to which this is known, considering the deposit type. If the relationship between the drilling orientation and the orientation of key mineralised structures is considered to have introduced a sampling bias, this should be assessed and reported if material. 	<ul style="list-style-type: none"> Mineralisation is variable in dip (~40 to 70 degrees to the east) which can present a potential issue when drilling into steeply dipping mineralised zoned with vertically drilled surface holes. As such underground drillholes are given a higher priority during the generation of the geological model. Consideration of the lower level of confidence is given to the Resource classification where sub-optimal vertical-only surface holes exist. Drill fans are designed to intersect key faults and mineralised domain

Criteria	JORC Code explanation	Commentary
		boundaries at a high angle.
Sample security	<ul style="list-style-type: none"> The measures taken to ensure sample security. 	<ul style="list-style-type: none"> Samples are tracked from the core shed through the onsite laboratory and assay reported all within the acquire database. Access to the acquire database is controlled by Windows Authentication, with only data-entry licence holders having read-write access. The unsampled drill core and remaining half core is stored at the core shed. Pulp samples are stored within weather-proof storage containers.
Audits or reviews	<ul style="list-style-type: none"> The results of any audits or reviews of sampling techniques and data. 	<ul style="list-style-type: none"> Database audits have been undertaken as part of external Resource audits of the Cannington Mineral Resource in December 2004 and again in February 2011 by Golder Associates Pty Ltd. An internal BHP Billiton 'GAS' audit was conducted in March 2010.

Section 2: Reporting of Exploration Results

(Criteria listed in the preceding section also apply to this section)

Criteria	JORC Code explanation	Commentary
Mineral tenement and land tenure status	<ul style="list-style-type: none"> Type, reference name/number, location and ownership including agreements or material issues with third parties such as joint ventures, partnerships, overriding royalties, native title interests, historical sites, wilderness or national park and environmental settings. The security of the tenure held at the time of reporting along with any known impediments to obtaining a licence to operate in the area. 	<ul style="list-style-type: none"> N/A
Exploration done by other parties	<ul style="list-style-type: none"> Acknowledgment and appraisal of exploration by other parties. 	<ul style="list-style-type: none"> N/A
Geology	<ul style="list-style-type: none"> Deposit type, geological setting and style of mineralisation. 	<ul style="list-style-type: none"> N/A
Drill hole Information	<ul style="list-style-type: none"> A summary of all information material to the understanding of the exploration results including a tabulation of the following information for all Material drill holes: <ul style="list-style-type: none"> easting and northing of the drill hole collar elevation or RL (Reduced Level – elevation above sea level in metres) of the drill hole collar dip and azimuth of the hole down hole length and interception depth hole length. If the exclusion of this information is justified on the basis that the information is not Material and this exclusion does not detract from the understanding of the report, the Competent Person should clearly explain why this is the case. 	<ul style="list-style-type: none"> N/A

Criteria	JORC Code explanation	Commentary
Data aggregation methods	<ul style="list-style-type: none"> In reporting Exploration Results, weighting averaging techniques, maximum and/or minimum grade truncations (e.g. cutting of high grades) and cut-off grades are usually Material and should be stated. Where aggregate intercepts incorporate short lengths of high grade results and longer lengths of low grade results, the procedure used for such aggregation should be stated and some typical examples of such aggregations should be shown in detail. The assumptions used for any reporting of metal equivalent values should be clearly stated. 	<ul style="list-style-type: none"> N/A
Relationship between mineralisation widths and intercept lengths	<ul style="list-style-type: none"> These relationships are particularly important in the reporting of Exploration Results. If the geometry of the mineralisation with respect to the drill hole angle is known, its nature should be reported. If it is not known and only the down hole lengths are reported, there should be a clear statement to this effect (e.g. 'down hole length, true width not known). 	<ul style="list-style-type: none"> N/A
Diagrams	<ul style="list-style-type: none"> Appropriate maps and sections (with scales) and tabulations of intercepts should be included for any significant discovery being reported. These should include, but not be limited to a plan view of drill hole collar locations and appropriate sectional views. 	<ul style="list-style-type: none"> N/A
Balanced reporting	<ul style="list-style-type: none"> Where comprehensive reporting of all Exploration Results is not practicable, representative reporting of both low and high grades and/or widths should be practiced to avoid misleading reporting of Exploration Results. 	<ul style="list-style-type: none"> N/A
Other substantive exploration data	<ul style="list-style-type: none"> Other exploration data, if meaningful and material, should be reported including (but not limited to): geological observations; geophysical survey results; geochemical survey results; bulk samples – size and method of treatment; metallurgical test results; bulk density, groundwater, geotechnical and rock 	<ul style="list-style-type: none"> N/A

Criteria	JORC Code explanation	Commentary
Further work	<p>characteristics; potential deleterious or contaminating substances.</p> <ul style="list-style-type: none"> The nature and scale of planned further work (e.g. tests for lateral extensions or depth extensions or large-scale step-out drilling). Diagrams clearly highlighting the areas of possible extensions, including the main geological interpretations and future drilling areas, provided this information is not commercially sensitive. 	<ul style="list-style-type: none"> N/A

Section 3: Estimation and Reporting of Mineral Resources

(Criteria listed in section 1, and where relevant in section 2, also apply to this section)

Criteria	JORC Code explanation	Commentary
Database integrity	<ul style="list-style-type: none"> Measures taken to ensure that data has not been corrupted by, for example, transcription or keying errors, between its initial collection and its use for Mineral Resource estimation purposes. Data validation procedures used. 	<ul style="list-style-type: none"> Prior to February 2011, the Cannington drillhole database was maintained in an Oracle relational database by HATCH Associates (Perth) with an identical copy stored onsite on the Cannington server, WMINCAN_SERVER. The Oracle database and management system included checking and validation routines and procedures to which Cannington personnel had read only access. This database was deemed suitable for Mineral Resource estimation purposes during an external Mineral Resource audit conducted by Golder Associates in February 2011. In February 2011, the drillhole database was transferred to a Cannington managed acquire relational database. Extensive validation work was undertaken by Cannington personnel to ensure the acquire database was suitable for Mineral Resource estimation purposes.
Site visits	<ul style="list-style-type: none"> Comment on any site visits undertaken by the Competent Person and the outcome of those visits. If no site visits have been undertaken indicate why this is the case. 	<ul style="list-style-type: none"> The Competent Person for Cannington Mineral Resource is based at the Cannington mine.

Criteria	JORC Code explanation	Commentary
Geological interpretation	<ul style="list-style-type: none"> • Confidence in (or conversely, the uncertainty of) the geological interpretation of the mineral deposit. • Nature of the data used and of any assumptions made. • The effect, if any, of alternative interpretations on Mineral Resource estimation. • The use of geology in guiding and controlling Mineral Resource estimation. • The factors affecting continuity both of grade and geology. 	<ul style="list-style-type: none"> • Cannington is a Broken Hill Type massive sulphide deposit. Extensive close-spaced drilling and ongoing mining since underground operations commenced in 1997 has provided a high level of confidence in the geological interpretation of the Cannington deposit. • The Ag-Pb-Zn mineralised system at Cannington is complex and multi-phase, and is associated with a diverse package of siliceous and mafic rocks with extensive retrogression and alteration. A zoning of base metals is evident within the resource which is deformed by the interpreted D2 isoclinal fold structure. • The Cannington ores have been subdivided into ten mineralisation types based on a complex set of criteria, including base metal geochemistry, trace element geochemistry, mineralogy, structural position and texture. • Lithology, mineralisation type and Ag, Pb, and Zn high-grade zones are interpreted on 12.5m spaced E-W sections that correspond to underground drillhole fans. • Underground drillhole data is given preference to surface drilling due to the perceived lower accuracy in down-hole surveying for surface drillholes. • Mineralisation is strataform along the limbs of a tight (70-90m wide) isoclinal recumbent synform. The two limbs of the fold dip between 40 and 70 degrees to the east and the fold has an overall southerly plunge. The core of the synform is composed of amphibolite with Ag, Pb and Zn mineralisation wrapped around it and hosted within a garnetiferous quartzite. Unmineralised, narrow, banded muscovite schist is intercalated with the mineralised zones. The sequence is cut by a series of unmineralised pegmatite dykes that post-date mineralisation. • The sinistral (northside up) Trepell Fault divides the deposit into North and South Zones. Other major faults such as the Hamilton Fault and Bird Faults in the South Zone are used to aid interpretation but are not used in the resource estimation process due to their highly localized and inconsistent disruption to mineralisation.

Criteria	JORC Code explanation	Commentary
Dimensions	<ul style="list-style-type: none"> The extent and variability of the Mineral Resource expressed as length (along strike or otherwise), plan width, and depth below surface to the upper and lower limits of the Mineral Resource. 	<ul style="list-style-type: none"> The Cannington Mineral Resource extends 2,050m along strike, 960m plan width and 900m vertically. Mineralisation terminates to the north at the overlying Cretaceous unconformity.
Estimation and modelling techniques	<ul style="list-style-type: none"> The nature and appropriateness of the estimation technique(s) applied and key assumptions, including treatment of extreme grade values, domaining, interpolation parameters and maximum distance of extrapolation from data points. If a computer assisted estimation method was chosen include a description of computer software and parameters used. The availability of check estimates, previous estimates and/or mine production records and whether the Mineral Resource estimate takes appropriate account of such data. The assumptions made regarding recovery of by-products. Estimation of deleterious elements or other non-grade variables of economic significance (e.g. sulphur for acid mine drainage characterisation). In the case of block model interpolation, the block size in relation to the average sample spacing and the search employed. Any assumptions behind modelling of selective mining units. Any assumptions about correlation between variables. Description of how the geological interpretation was used to control the resource estimates. Discussion of basis for using or not using grade cutting or capping. The process of validation, the checking process used, the comparison of model data to drill hole data, and use of reconciliation data if available. 	<ul style="list-style-type: none"> Drillhole samples are flagged to individual mineralization types, lithologies and metal zones using interpreted strings on 12.5m sections, then composited to 2m. Grade zoning into high and low grade categories of material is considered appropriate because of the generally sharp transition between higher grade portions and the lower grade portions of the deposit. Structural domains are defined on local orientations of the mineralization type and assigned to samples. Variography is undertaken on the composited drillhole data for each structural domain. Grade is interpolated into blocks of 8mE x 12.5mN x 8mRL size using an Ordinary Kriging grade interpolator for silver, lead and zinc in Datamine Studio 3 mining software. The block size selected is deemed appropriate for detailed stope design and mine planning. Grade interpolation is run in three passes, with search ellipse dimensions related to modelled variography ranges for each domain. Octant based sample searching and limiting the maximum number of samples from a single drillhole are used to assist in declustering. Inverse Distance weighting was used to interpolate grades of minor elements of iron, arsenic, bismuth and magnesium oxide. Iron is used in the estimation of bulk density for tonnage calculation whilst the remaining elements impact on the efficiency of the processing recoveries. Outlier analysis (top cutting) was assessed using a metal-at-risk approach and resulted in no top cuts being applied. Inverse distance weighting was used as a check estimate for Ag, Pb, Zn and Fe to compare with the Kriged estimates.

Criteria	JORC Code explanation	Commentary
Moisture	<ul style="list-style-type: none"> Whether the tonnages are estimated on a dry basis or with natural moisture, and the method of determination of the moisture content. 	<ul style="list-style-type: none"> Global validation between global mean grades from drillhole composite data and the block estimates is statistically assessed and visually assessed using swathe plots. In addition, the resource estimate is compared to previous estimates by analysing the changes, both globally and locally, within planned stopes. Tonnes are estimated on a dry basis.
Cut-off parameters	<ul style="list-style-type: none"> The basis of the adopted cut-off grade(s) or quality parameters applied. 	<ul style="list-style-type: none"> Due to the polymetallic nature of the economic mineralisation at Cannington, a dollar equivalent cut-off value is used for reporting the Mineral Resource. Cannington being a polymetallic deposit utilises an equivalent dollar value (DoLBEE) for a grade descriptor. DoLBEE considers the remaining gross value of the insitu metal once mill recovery, royalty and concentrate transport and treatment costs have been considered. The DOLBEE has been updated using June 2014 investment and value management group forecasts for Silver, Lead and Zinc, FX, treatment and refining charges. The mid-price forecast is used for Silver while the high-price forecast is used for Lead and Zinc. A cut-off Dollar equivalent value of \$90/t for underground Resource and \$45/t for open pit Resource has been applied. These cut-off values have been determined as the minimum required for potential economic extraction by suitable underground or open pit mining methods.
Mining factors or assumptions	<ul style="list-style-type: none"> Assumptions made regarding possible mining methods, minimum mining dimensions and internal (or, if applicable, external) mining dilution. It is always necessary as part of the process of determining reasonable prospects for eventual economic extraction to consider potential mining methods, but the assumptions made regarding mining methods and parameters when estimating 	<ul style="list-style-type: none"> Cannington has been operating as an underground long hole open stope mine since 1997. The mining method is appropriate to the style of the Cannington deposit. Geological interpretation has defined mineralisation and waste lithologies. When stopes are designed any internal waste is assigned a zero grade. Upon completion of the Resource model, all previous mined stopes and

Criteria	JORC Code explanation	Commentary
Metallurgical factors or assumptions	<p>Mineral Resources may not always be rigorous. Where this is the case, this should be reported with an explanation of the basis of the mining assumptions made.</p> <ul style="list-style-type: none"> The basis for assumptions or predictions regarding metallurgical amenability. It is always necessary as part of the process of determining reasonable prospects for eventual economic extraction to consider potential metallurgical methods, but the assumptions regarding metallurgical treatment processes and parameters made when reporting Mineral Resources may not always be rigorous. Where this is the case, this should be reported with an explanation of the basis of the metallurgical assumptions made. 	<p>development are depleted from the model and assigned a zero grade. Stopes are allocated a set paste density of 2.2 and development is assigned a density of 0.</p> <ul style="list-style-type: none"> The Dollar equivalent value includes an assumption of recovery based on historical recoveries at Cannington. These recovery assumptions are updated annually to include reconciled recovery for the preceding year's production.
Environmental factors or assumptions	<ul style="list-style-type: none"> Assumptions made regarding possible waste and process residue disposal options. It is always necessary as part of the process of determining reasonable prospects for eventual economic extraction to consider the potential environmental impacts of the mining and processing operation. While at this stage the determination of potential environmental impacts, particularly for a greenfields project, may not always be well advanced, the status of early consideration of these potential environmental impacts should be reported. Where these aspects have not been considered this should be reported with an explanation of the environmental assumptions made. 	<ul style="list-style-type: none"> Cannington is an operating underground mine with known environment impacts of mining and processing. A large proportion of the gangue material from the mill processing is mixed with cement and pumped back underground to backfill emptied stopes. Small volumes of waste rock are trucked to surface and confined to the base of the ROM pad.

Criteria	JORC Code explanation	Commentary
Bulk density	<ul style="list-style-type: none"> Whether assumed or determined. If assumed, the basis for the assumptions. If determined, the method used, whether wet or dry, the frequency of the measurements, the nature, size and representativeness of the samples. The bulk density for bulk material must have been measured by methods that adequately account for void spaces (vugs, porosity, etc), moisture and differences between rock and alteration zones within the deposit. Discuss assumptions for bulk density estimates used in the evaluation process of the different materials. 	<ul style="list-style-type: none"> Bulk density measurements have been obtained in campaign programmes since 1997 using the Archimedean water displacement technique. Density has been estimated in the block model using regression relationships between measured bulk density and block grades, according to interpreted Mineralisation Type. It has been assumed that the bulk density is equivalent to the dry insitu density as macro-porosity of the Cannington deposit is approximately 0% by volume and free moisture content is also approximately 0% by weight. In 2007 a programme was completed to confirm the density algorithm derived from regression relationships used since 1999. This work involved taking samples from underground stope drawpoints and resulted in new density formulae being used for the June 2007 to June 2011 Mineral Resource estimates. In 2012, another review of the density formulae was undertaken to include additional drill core density measurements (Archimedean technique) and additional stope grab samples. The new density formulae were derived using a matrices based spreadsheet and has been used since June 2012. All mined stopes are allocated a default density of 2.2 and development is assigned a density of zero.
Classification	<ul style="list-style-type: none"> The basis for the classification of the Mineral Resources into varying confidence categories. Whether appropriate account has been taken of all relevant factors (ie relative confidence in tonnage/grade estimations, reliability of input data, confidence in continuity of geology and metal values, quality, quantity and distribution of the data). Whether the result appropriately reflects the Competent Person’s view of the deposit. 	<ul style="list-style-type: none"> Cannington classifies the Mineral Resource into Measured, Indicated and Inferred based on drill hole spacing of 12.5m, 25m, >25m respectively. Although statistically there it has been determined that 25m drillhole spacing is unlikely to create a bias on a global resource estimate scale, local variation requires 12.5m spacing to effectively define mineralisation / waste boundaries. The increased geological knowledge provided by 12.5m drillhole spacing is therefore considered to be required to obtain the high level of confidence for a Measured

Criteria	JORC Code explanation	Commentary
Audits or reviews	<ul style="list-style-type: none"> The results of any audits or reviews of Mineral Resource estimates. 	<p>Resource classification.</p> <ul style="list-style-type: none"> An external audit of the Cannington Mineral Resource was undertaken in December 2004 and again in February 2011 by Golder Associates Pty Ltd. An internal BHP Billiton 'GAS' audit was conducted in March 2010 and again in 2012.
Discussion of relative accuracy/confidence	<ul style="list-style-type: none"> Where appropriate a statement of the relative accuracy and confidence level in the Mineral Resource estimate using an approach or procedure deemed appropriate by the Competent Person. For example, the application of statistical or geostatistical procedures to quantify the relative accuracy of the resource within stated confidence limits, or, if such an approach is not deemed appropriate, a qualitative discussion of the factors that could affect the relative accuracy and confidence of the estimate. The statement should specify whether it relates to global or local estimates, and, if local, state the relevant tonnages, which should be relevant to technical and economic evaluation. Documentation should include assumptions made and the procedures used. These statements of relative accuracy and confidence of the estimate should be compared with production data, where available. 	<ul style="list-style-type: none"> Cannington has employed a detailed methodology for constructing block models and this has been audited internally and externally, most recently by Golder Associates in 2011. Golder identified actions in the areas of Assay, Database and Resource Modelling, none of which were material risks, that they recommended be completed prior to the next resource estimate. These actions are resourced and scheduled for completion during 2014 calendar year. Quarterly reconciliations demonstrate that lead and zinc grades are within five per cent of the Mineral Resource model estimates. Silver has a systematic bias of under-calling by nine to ten percent. A review of the Cannington laboratory analytical procedures and instrumentation as well as a review of the current Mineral Resource estimation process are amongst a number of studies currently in place to address this bias.

Section 4: Estimation and Reporting of Ore Reserves

(Criteria listed in section 1, and where relevant in sections 2 and 3, also apply to this section)

Criteria	JORC Code explanation	Commentary
Mineral Resource estimate for conversion to Ore Reserves	<ul style="list-style-type: none"> Description of the Mineral Resource estimate used as a basis for the conversion to an Ore Reserve. Clear statement as to whether the Mineral Resources are reported additional to, or inclusive of, the Ore Reserves. 	<ul style="list-style-type: none"> The Ore Reserve estimate is based on the Mineral Resource model created internally at Cannington. Ag, Pb, Zn, Fe grades are interpolated into cells using Ordinary Kriging technique with geological domaining. The model is overlain with a void model representing the extracted areas from stoping and development. The model used for the Ore Reserves is consistent in with that produced for the Mineral Resource estimation. The variations to the model used for Mineral Resource is the date that void model was updated, June 2013, and the adjustment to the equivalent dollar field, DoIBEE to consider Mid commodity price forecasts. This model is internally known as: <ul style="list-style-type: none"> p2130r.m The Mineral Resources are reported inclusive of the Ore Reserves
Site visits	<ul style="list-style-type: none"> Comment on any site visits undertaken by the Competent Person and the outcome of those visits. If no site visits have been undertaken indicate why this is the case. 	<ul style="list-style-type: none"> The Competent Person makes regular monthly site visits to attend meetings and interact with the site technical teams. Outcome of site visits include but are not limited to review of asset performance and reconciliation of modifying factors to those used in the reserve estimate.
Study status	<ul style="list-style-type: none"> The type and level of study undertaken to enable Mineral Resources to be converted to Ore Reserves. The Code requires that a study to at least Pre-Feasibility Study level has been undertaken to convert Mineral Resources to Ore Reserves. Such studies will have been carried out and will have determined a mine plan that is technically achievable and economically viable, and that material Modifying Factors have been considered. 	<ul style="list-style-type: none"> Cannington Mine has been operating since 1997. A Life of Asset plan is updated annually to support the Ore Reserve Estimate. The fiscal year 2015 Life of Asset (LoA) Optimised Base Plan (OBP) provides the mine physical schedule and from which for the 30th June, 2014 Ore Reserves are derived and evaluated.

Criteria	JORC Code explanation	Commentary
Cut-off parameters	<ul style="list-style-type: none"> The basis of the cut-off grade(s) or quality parameters applied. 	<ul style="list-style-type: none"> The revenue generating cut-off parameters used for the Cannington underground mining method consider Silver, Lead and Zinc grades. Cannington being a polymetallic deposit utilises an equivalent dollar value called DoLBEE for a grade descriptor. DoLBEE considers the remaining gross value of the insitu metal once mill recovery, royalty and concentrate transport and treatment costs have been considered. A dollar equivalent cut-off value (DoLBEE) of A\$140/t is used based on the following grades and associated multipliers, $DoLBEE = Ag (g/t) \times 0.61 + Pb (\%) \times 13.23 + Zn (\%) \times 7.63$ The equivalent grade profile at A\$140/t averages 99g/t Ag, 4.40% Pb and 2.82% Zn. The cut-off strategy employed at Cannington is to optimise the Net Present Value (NPV) of the Asset.
Mining factors or assumptions	<ul style="list-style-type: none"> The method and assumptions used as reported in the Pre-Feasibility or Feasibility Study to convert the Mineral Resource to an Ore Reserve (i.e. either by application of appropriate factors by optimisation or by preliminary or detailed design). The choice, nature and appropriateness of the selected mining method(s) and other mining parameters including associated design issues such as pre-strip, access, etc. The assumptions made regarding geotechnical parameters (e.g. pit slopes, stope sizes, etc.), grade control and pre-production drilling. The major assumptions made and Mineral Resource model used for pit and stope optimisation (if appropriate). The mining dilution factors used. The mining recovery factors used. Any minimum mining widths used. The manner in which Inferred Mineral Resources are utilised in mining studies and the sensitivity of the outcome to their inclusion. 	<ul style="list-style-type: none"> The Ore Reserve has been estimated after an annual update of the Life of Asset base plan that improves NPV relative to the previous optimised base plan under the same conditions. This update includes a detailed design and sequencing of stopes and development using manual techniques with updated modifying factors. The Mineral Resource inside each stope design is what is used for reporting, given that it satisfies less than 30% total Inferred Resource and the weighted average DoLBEE is above \$140/t cut-off. Ore Development that is outside of a stope is not considered for inclusion in Reserves as it has a high likelihood of varying in spatial location with future plans. The underground mining method used at Cannington is Sub Level Open Stopping (SLOS). The stopes are accessed by underground mine development that facilitates production activities. Ore is transported to surface via the hoist or by truck. Stope design and mining sequences are reviewed against geotechnical parameters, plant capacity constraints and historical operating rates. Mining dilution and recovery factors are updated annually and vary with consideration to the attributes of individual mining blocks. These

Criteria	JORC Code explanation	Commentary
	<ul style="list-style-type: none"> The infrastructure requirements of the selected mining methods. 	<p>factors are based on individual stope reconciliations of approximately 330 stopes dating back to 2005.</p> <ul style="list-style-type: none"> Geology tonnes and grade factors are based on monthly reconciliations between mine production and sampled Mill Feed Grades during July 2010 to March 2014. These factors are considered as a function of the Resource model and as such these factors are applied globally to improve the Ore Reserve estimate. Tonnage factor – 100% Ag factor – 108% Pb Factor – 101% Zn Factor – 100% A minimum mining width of 5m was applied for all design work. Typically the Selective Mining Unit (SMU) of 20m x 20m x 20m has been used for mine stope design. Inferred Mineral Resources are incorporated into stope designs and contribute to the overall weighted grades, cutoff and value of the stope. Stopes that contain greater than 30% of Inferred Mineral Resource are completely removed from the Ore Reserve Estimate. The declared Ore Reserve estimate is exclusive of any remaining Inferred Mineral Resource. Inferred material contained within the stopes used for generating the Ore Reserve estimate is approximately 2%. The infrastructure requirements of the current mining method are already in place. Decline access, extensive level access development, 6 ventilation exhaust shafts, 1 hoisting shaft/intake shaft, 7 ore passes feeding an underground crusher is the main underground infrastructure currently employed at Cannington.

Criteria	JORC Code explanation	Commentary
Metallurgical factors or assumptions	<ul style="list-style-type: none"> The metallurgical process proposed and the appropriateness of that process to the style of mineralisation. Whether the metallurgical process is well-tested technology or novel in nature. The nature, amount and representativeness of metallurgical test work undertaken, the nature of the metallurgical domaining applied and the corresponding metallurgical recovery factors applied. Any assumptions or allowances made for deleterious elements. The existence of any bulk sample or pilot scale test work and the degree to which such samples are considered representative of the orebody as a whole. For minerals that are defined by a specification, has the ore reserve estimation been based on the appropriate mineralogy to meet the specifications? 	<ul style="list-style-type: none"> A full scale metallurgical process plant has been operating at Cannington since production commenced in 1997. It produces three products – a sliver rich high quality lead concentrate, a zinc concentrate and paste fill for backfilling of voids underground. The process consists of six core processes to treat ore; crushing, grinding, floatation, leaching, de-watering and paste fill preparation. The plant is capable of processing at a 3.4Mtpa rate and is now well-established. Predicted mill recoveries are derived from historic recovery regression curves and applied to future planned feed grades in the life of asset plan. Average recovery factors used are: <ul style="list-style-type: none"> Ag 87% Pb 86% Zn 79% Allowances for both Fe and F are made in the derivation of the equivalent dollar value (DoIBEE) used for mine design purposes based on contract agreements. The impact of processing mineral types containing high Arsenic, Iron, Flourine and Magnesium Oxide are limited due to the ability to maintain below threshold levels through effective blending and removal in the flouride leach circuit.
Environmental	<ul style="list-style-type: none"> The status of studies of potential environmental impacts of the mining and processing operation. Details of waste rock characterisation and the consideration of potential sites, status of design options considered and, where applicable, the status of approvals for process residue storage and waste dumps should be reported. 	<ul style="list-style-type: none"> Cannington has a current Environmental Authority (EA) under which an Environmental Management Plan (EMP) and a Plan of Operations has been submitted to and approved by the Queensland State Government through the Department of Environment and Heritage Protection. Cannington has a current approved Closure Plan which is a rehabilitation requirement of the EMP. The estimated closure date from is FY2023 with subsequent planned relinquishment date in FY2037 after four years of rehabilitation and ten years of post-closure monitoring.

Criteria	JORC Code explanation	Commentary
Infrastructure	<ul style="list-style-type: none"> The existence of appropriate infrastructure: availability of land for plant development, power, water, transportation (particularly for bulk commodities), labour, accommodation; or the ease with which the infrastructure can be provided, or accessed. 	<ul style="list-style-type: none"> Cannington mine has been producing since 1997 and at annual rates greater than 3Mtpa since 2005 which is supported by the current installed infrastructure on BHP Billiton held tenements and leases including but not limited to: <ul style="list-style-type: none"> Dedicated Gas/Diesel power plant Processing Plant, warehouse, core yard, tailings storage facilities, administration offices, laboratory buildings Surface roads and communication Accommodation, sewage treatment plant and camp facilities Surface Magazine Yurbi rail transfer station Port and ship loading facility Airstrip Cannington currently holds a license for water take from the Great Artesian Basin (GAB) for up to 2.2GL annually and granted by Mining Lease 90060 "Cannington Borefield Lease". This mining lease for Mining and Water Supply, granted under the Mineral Resources Act, 1989 and the Environmental Protection Act 1994, is held for the term of 35 years, until 2030.
Costs	<ul style="list-style-type: none"> The derivation of, or assumptions made, regarding projected capital costs in the study. The methodology used to estimate operating costs. Allowances made for the content of deleterious elements. The derivation of assumptions made of metal or commodity price(s), for the principal minerals and co- products. The source of exchange rates used in the study. Derivation of transportation charges. The basis for forecasting or source of treatment and refining charges, penalties for failure to meet specification, etc. The allowances made for royalties payable, both Government and 	<ul style="list-style-type: none"> Capital costs based on current Cannington site experience for future horizontal and vertical development, tailings facilities and processing and mining sustaining capital. Operating costs are estimated as part of the internal budgeting process and consist of both fixed and variable components. Fixed components of operating costs form the FY15 Life of Asset Optimised Base Plan have been allocated to the reduced Ore Reserves production profile. Fixed operating costs are scaled down at an 80-60-40% rate for the end of the mine life. There are no allowances made for deleterious elements in the LoA evaluation and are expected to remain non material.

Criteria	JORC Code explanation	Commentary
	private.	<ul style="list-style-type: none"> Commodity price forecasts for Silver, Lead and Zinc which are used for the FY15 LoA OBP evaluation are supplied by BHP Billiton Investments and Value Management (I&VM) Group and based on the June 2103 Mid Protocols. As inputs into the DoIBEE calculation for mine design purposes, the values used are derived from the June 2013 Mid Protocols and are based on a 10 year average (FY14-23) to approximately represent the remaining mine life. Exchange rates for the FY15 LoA OBP evaluation are supplied by BHP Billiton Investments and Value Management (I&VM) Group and based on the June 2013 Mid Protocols. As inputs into the DoIBEE calculation for mine design purposes, the values used are derived from the June 2013 Mid Protocols and are based on a 10 year average (FY14-23) to approximately represent the remaining mine life. Transport charges are based on current truck, rail and shipping contracts and are estimated as part of the internal budgeting process for Port and Yurbi materials handling. Treatment and Refining Charges for the FY15 LoA OBP evaluation are supplied by BHP Billiton Investments and Value Management (I&VM) Group and based on the January 2014 Mid Protocols. As inputs into the DoIBEE calculation for mine design purposes, the values used are derived from the June 2013 Mid Protocols and are based on a 10 year average (FY14-23) to approximately represent the remaining mine life. There is no allowance for penalties for failure to meet product specifications. Royalties have been included at the Queensland State Government royalty of 4.65% of revenue for combined economic minerals.

Criteria	JORC Code explanation	Commentary
Revenue factors	<ul style="list-style-type: none"> • The derivation of, or assumptions made regarding revenue factors including head grade, metal or commodity price(s) exchange rates, transportation and treatment charges, penalties, net smelter returns, etc. • The derivation of assumptions made of metal or commodity price(s), for the principal metals, minerals and co-products. 	<ul style="list-style-type: none"> • Revenue is calculated by applying forecast metal prices and foreign exchange rates to the scheduled payable metal. Payable metal rates used are: <ul style="list-style-type: none"> ○ Lead concentrate payable Lead – 95% ○ Lead concentrate payable Silver – 95% ○ Zinc concentrate payable Zinc – 83% ○ Zinc concentrate non-payable Silver – 93.31g/t ○ Zinc concentrate payable Silver – 70% • Commodity price forecasts for Silver, Lead and Zinc which are used for the LoA15 OBP evaluation are supplied by BHP Billiton Investments and Value Management (I&VM) Group and based on the June 2103 Mid Protocols. • The Ore Reserves valuation model receives revenue from the Inferred Resource material and is fully costed.
Market assessment	<ul style="list-style-type: none"> • The demand, supply and stock situation for the particular commodity, consumption trends and factors likely to affect supply and demand into the future. • A customer and competitor analysis along with the identification of likely market windows for the product. • Price and volume forecasts and the basis for these forecasts. • For industrial minerals the customer specification, testing and acceptance requirements prior to a supply contract. 	<ul style="list-style-type: none"> • Lead – Primary lead demand is expected to exceed 6Mt in 2020, up from 5Mt in 2012. This demand is not expected to be met with current operating mines and will rely on new sources to be developed. Strong demand still exists for Lead with the key drive of consumption being in the automotive industry including a recent trend in the growth of electric bikes. • Zinc – Primary zinc demand is expected to exceed 16Mt in 2020, up from 13Mt in 2011. This demand is not expected to be met with current operating mines and will rely on new sources to be developed. The key driver for Zinc in this period is expected to be industrialization and fixed asset investment of China. • Silver – acts more like a currency than a consumption commodity and has recently experienced some volatile changes in its spot price. Silver, being a precious metal, is well recognised for being effective as an inflation hedge and insurance against economic and political disruptions.

Criteria	JORC Code explanation	Commentary
Economic	<ul style="list-style-type: none"> The inputs to the economic analysis to produce the net present value (NPV) in the study, the source and confidence of these economic inputs including estimated inflation, discount rate, etc. NPV ranges and sensitivity to variations in the significant assumptions and inputs. 	<ul style="list-style-type: none"> The LoA15 OBP economic analysis is performed by the Finance Department at Cannington. The valuation model uses current site operating costs (including future reversion aligned with cost saving reviews), 5YP and LoA OBP capital costs, OBP physicals (tonnes, grade and recoveries), BHP Billiton I&VM price protocols, foreign exchange and discount rate (supplied by I&VM). The same evaluation model created for the FY15 LoA OBP was used for the 30th June 2014 Ore Reserve Estimate. The Ore Reserve evaluation model generated a NPV of US\$1.15B using the BHP Billiton Minerals Discount Rate of 7.5%. Sensitivity analysis conducted on the Ore Reserve evaluation considered variance to grades, commodity prices, CAPEX, OPEX and mill recovery. Key variables that impacted on the value of the Ore Reserves were identified as Silver price and OPEX costs. The conclusion of the analysis was that the JORC Ore Reserve estimate is robust against realistic changes in OPEX and Silver price maintaining a positive NPV and cash flow in these scenarios. This assists in improving the overall confidence level of the Ore Reserve estimate.
Social	<ul style="list-style-type: none"> The status of agreements with key stakeholders and matters leading to social licence to operate. 	<ul style="list-style-type: none"> Cannington maintains excellent relationships with external stakeholders – including Indigenous, government, business and community – through structured and meaningful stakeholder engagement activities. These include a range of community participation led activities including community investment allocation, business – community interaction, perception surveys and feedback mechanisms. Due to the nature and location of Cannington’s operations, these activities are implemented across all three local government areas of McKinlay, Cloncurry and Townsville.

Criteria	JORC Code explanation	Commentary
Other	<ul style="list-style-type: none"> To the extent relevant, the impact of the following on the project and/or on the estimation and classification of the Ore Reserves: Any identified material naturally occurring risks. The status of material legal agreements and marketing arrangements. The status of governmental agreements and approvals critical to the viability of the project, such as mineral tenement status, and government and statutory approvals. There must be reasonable grounds to expect that all necessary Government approvals will be received within the timeframes anticipated in the Pre-Feasibility or Feasibility study. Highlight and discuss the materiality of any unresolved matter that is dependent on a third party on which extraction of the reserve is contingent. 	<ul style="list-style-type: none"> An internal risk register is maintained to address and mitigate against all foreseeable risks that could impact on the Ore Reserve Current operating asset, with no outstanding or foreseeable issues with material legal agreements. Marketing arrangements are in place with long-term smelter supply contracts in various geopolitical regions. Cannington Mine operates within the Mining Lease ML90059, which was granted to BHP Minerals PTY Ltd on 1st January 1995 for the term of 35 years. This mining lease for the purposes of mining stated minerals was granted under the Mineral Resources Act, 1989 and the Environmental Protection Act, 1994 and expires on 15th December 2029. The Cannington loading facilities at Yurbi including a concentrate shed and railhead are contained within the Mining Lease ML 90077. This Mining Lease, for the purposes of Loading Facilities (Railway) and Stock Pile Ore (Overburden), was granted to BHP Minerals Pty Ltd on January 1st 1996 for the term of 35 years. The FY15 Life of Asset (LoA) Optimised Base Plan (OBP), from which the Ore Reserves estimate is based on, considers a mine life until FY2023; which is within the expiring date of all mining leases.

Criteria	JORC Code explanation	Commentary
Classification	<ul style="list-style-type: none"> The basis for the classification of the Ore Reserves into varying confidence categories. Whether the result appropriately reflects the Competent Person's view of the deposit. The proportion of Probable Ore Reserves that have been derived from Measured Mineral Resources (if any). 	<ul style="list-style-type: none"> Ore Reserves have been classified based on the Mineral Resource category. Measured Mineral Resource has been classified as Proved Ore Reserves and Indicated Mineral Resource has been classified as Probable Ore Reserves. Inferred Mineral Resource is not declared in the total Ore Reserves. In terms of declaration, the Cannington CP for Ore Reserves determined that some of the measured and indicated resources in the FY15 LoA OBP production stream will not be converted into Proved and Probable Reserves due to the need for further technical studies to be completed. The excluded Mineral Resource is contained within two new mining blocks, the North Zone Outer & North Zone Upper Blocks, with the characteristics of marginal grades with technical challenges. The ratio of the Proved to Probable Ore Reserves and small percentage of Inferred Mineral Resource supports that the Cannington deposit is well understood and defined through definition drilling and consistent compliance to planned physicals. There are no Probable Ore Reserves derived from Measured Mineral Resource.
Audits or reviews	<ul style="list-style-type: none"> The results of any audits or reviews of Ore Reserve estimates. 	<ul style="list-style-type: none"> No external audits or reviews have been conducted on the current Ore Reserve estimate. 2011 – Xstract Consultants were engaged to conduct an independent audit of the Ore Reserves. It was concluded that the estimation of the Ore Reserve had been undertaken to a high standard and level of detail and complies with the JORC Code 2004 and internal BHP Billiton guidelines. 2012 - Internal GAS Audit. No material issues identified with a recommendation to document procedures for developing the Ore Reserve estimate.

Criteria	JORC Code explanation	Commentary
Discussion of relative accuracy/confidence	<ul style="list-style-type: none"> • Where appropriate a statement of the relative accuracy and confidence level in the Ore Reserve estimate using an approach or procedure deemed appropriate by the Competent Person. For example, the application of statistical or geostatistical procedures to quantify the relative accuracy of the reserve within stated confidence limits, or, if such an approach is not deemed appropriate, a qualitative discussion of the factors which could affect the relative accuracy and confidence of the estimate. • The statement should specify whether it relates to global or local estimates, and, if local, state the relevant tonnages, which should be relevant to technical and economic evaluation. Documentation should include assumptions made and the procedures used. • Accuracy and confidence discussions should extend to specific discussions of any applied Modifying Factors that may have a material impact on Ore Reserve viability, or for which there are remaining areas of uncertainty at the current study stage. • It is recognised that this may not be possible or appropriate in all circumstances. These statements of relative accuracy and confidence of the estimate should be compared with production data, where available. 	<ul style="list-style-type: none"> • The Ore Reserves are based on a set of stopes of sufficient value to maintain a stable reporting platform and positive NPV over an expected range of modifying factors. • Sensitivity analysis has identified any variation in the applied silver price can have the most impact on the Ore Reserves. A lower case (30% decrease) for Silver price has been demonstrated to still provide a viable mine plan with positive cash flow and NPV. • A significant proportion of the Ore Reserves are derived from Measured Resource with a high level of geological certainty and a low percentage of Inferred Mineral Resource. • Resource Material has also been excluded from the Ore Reserves based on the requirement of further technical work required to better understand modifying factors and potential risks in the selected mining method, economics and recovery assumed for new areas. • The high confidence in the Ore Reserves estimate is supported by the FY14 actuals/forecast (as of 01/05/2014) against budgeted mine production with <ul style="list-style-type: none"> ○ 0.7% variance in tonnage ○ -0.3% variance in Ag grades ○ -1.4% variance in Pb grades ○ 4.2 variance in Zn grades

Section 5: Estimation and Reporting of Diamonds and Other Gemstones

(Criteria listed in other relevant sections also apply to this section. Additional guidelines are available in the 'Guidelines for the Reporting of Diamond Exploration Results' issued by the Diamond Exploration Best Practices Committee established by the Canadian Institute of Mining, Metallurgy and Petroleum)

Criteria	JORC Code explanation	Commentary
Indicator minerals	<ul style="list-style-type: none"> Reports of indicator minerals, such as chemically/physically distinctive garnet, ilmenite, chrome spinel and chrome diopside, should be prepared by a suitably qualified laboratory. 	<ul style="list-style-type: none"> N/A
Source of diamonds	<ul style="list-style-type: none"> Details of the form, shape, size and colour of the diamonds and the nature of the source of diamonds (primary or secondary) including the rock type and geological environment. 	<ul style="list-style-type: none"> N/A
Sample collection	<ul style="list-style-type: none"> Type of sample, whether outcrop, boulders, drill core, reverse circulation drill cuttings, gravel, stream sediment or soil, and purpose (e.g. large diameter drilling to establish stones per unit of volume or bulk samples to establish stone size distribution). Sample size, distribution and representivity. 	<ul style="list-style-type: none"> N/A
Sample treatment	<ul style="list-style-type: none"> Type of facility, treatment rate, and accreditation. Sample size reduction. Bottom screen size, top screen size and re-crush. Processes (dense media separation, grease, X-ray, hand-sorting, etc). Process efficiency, tailings auditing and granulometry. Laboratory used, type of process for micro diamonds and accreditation. 	<ul style="list-style-type: none"> N/A
Carat	<ul style="list-style-type: none"> One fifth (0.2) of a gram (often defined as a metric carat or MC). 	<ul style="list-style-type: none"> N/A

Criteria	JORC Code explanation	Commentary
Sample grade	<ul style="list-style-type: none"> • Sample grade in this section of Table 1 is used in the context of carats per units of mass, area or volume. • The sample grade above the specified lower cut-off sieve size should be reported as carats per dry metric tonne and/or carats per 100 dry metric tonnes. For alluvial deposits, sample grades quoted in carats per square metre or carats per cubic metre are acceptable if accompanied by a volume to weight basis for calculation. • In addition to general requirements to assess volume and density there is a need to relate stone frequency (stones per cubic metre or tonne) to stone size (carats per stone) to derive sample grade (carats per tonne). 	<ul style="list-style-type: none"> • N/A
Reporting of Exploration Results	<ul style="list-style-type: none"> • Complete set of sieve data using a standard progression of sieve sizes per facies. Bulk sampling results, global sample grade per facies. Spatial structure analysis and grade distribution. Stone size and number distribution. Sample head feed and tailings particle granulometry. • Sample density determination. • Per cent concentrate and undersize per sample. • Sample grade with change in bottom cut-off screen size. • Adjustments made to size distribution for sample plant performance and performance on a commercial scale. • If appropriate or employed, geostatistical techniques applied to model stone size, distribution or frequency from size distribution of exploration diamond samples. • The weight of diamonds may only be omitted from the report when the diamonds are considered too small to be of commercial significance. This lower cut-off size should be stated. 	<ul style="list-style-type: none"> • N/A

Criteria	JORC Code explanation	Commentary
Grade estimation for reporting Mineral Resources and Ore Reserves	<ul style="list-style-type: none"> Description of the sample type and the spatial arrangement of drilling or sampling designed for grade estimation. The sample crush size and its relationship to that achievable in a commercial treatment plant. Total number of diamonds greater than the specified and reported lower cut-off sieve size. Total weight of diamonds greater than the specified and reported lower cut-off sieve size. The sample grade above the specified lower cut-off sieve size. 	<ul style="list-style-type: none"> N/A
Value estimation	<ul style="list-style-type: none"> Valuations should not be reported for samples of diamonds processed using total liberation method, which is commonly used for processing exploration samples. To the extent that such information is not deemed commercially sensitive, Public Reports should include: <ul style="list-style-type: none"> Diamonds quantities by appropriate screen size per facies or depth. Details of parcel valued. Number of stones, carats, lower size cut-off per facies or depth. The average \$/carat and \$/tonne value at the selected bottom cut-off should be reported in US Dollars. The value per carat is of critical importance in demonstrating project value. The basis for the price (e.g. dealer buying price, dealer selling price, etc). An assessment of diamond breakage. 	<ul style="list-style-type: none"> N/A

Criteria	JORC Code explanation	Commentary
Security and integrity	<ul style="list-style-type: none"> • Accredited process audit. • Whether samples were sealed after excavation. • Valuer location, escort, delivery, cleaning losses, reconciliation with recorded sample carats and number of stones. • Core samples washed prior to treatment for micro diamonds. • Audit samples treated at alternative facility. • Results of tailings checks. • Recovery of tracer monitors used in sampling and treatment. • Geophysical (logged) density and particle density. • Cross validation of sample weights, wet and dry, with hole volume and density, moisture factor. 	<ul style="list-style-type: none"> • N/A

End of Report

This page has been intentionally left blank.

CORPORATE DIRECTORY

DIRECTORS

David Crawford
Chairman and Independent
Non-executive Director

Graham Kerr
Chief Executive Officer and
Executive Director

Keith Rumble
Independent Non-executive Director

Xolani Mkhwanazi
Non-executive Director

REGISTERED OFFICE

Level 20
Waterfront Place
1 Eagle Street
Brisbane Qld 4000
Australia

Telephone number: +61 8 9324 9000

CHIEF LEGAL OFFICER AND COMPANY SECRETARY

Nicole Duncan of:
Level 35
108 St Georges Terrace
Perth WA 6000
Australia

LEAD FINANCIAL ADVISER

Goldman Sachs
Level 17, 101 Collins Street
Melbourne VIC 3000
Australia

JOINT FINANCIAL ADVISER AND SPONSOR FOR THE JSE LISTING

UBS AG (as financial adviser)

UBS AG, Australia Branch
8 Exhibition Street
Melbourne VIC 3000
Australia

UBS South Africa (Pty) Limited (as sponsor for the JSE listing)

64 Wierda Road East
Wierda Valley, ZA-Sandton 2196
Johannesburg 2196 GTG
South Africa

INDEPENDENT BOARD ADVISERS TO THE BHP BILLITON BOARD

Gresham Advisory Partners Limited
Level 17, 167 Macquarie Street
Sydney NSW 2000
Australia

Investec Bank Limited
100 Grayston Drive
Sandown, Sandton 2196
South Africa

Simon Robertson Associates LLP
2 St James's Place
London SW1A 1NP
United Kingdom

INDEPENDENT ACCOUNTANT

**KPMG Financial Advisory Services
(Australia) Pty Ltd**
147 Collins Street
Melbourne VIC 3000
Australia

AUDITOR

**KPMG
Australia**
147 Collins Street
Melbourne VIC 3000
Australia

South Africa
KPMG Inc.
KPMG Crescent
85 Empire Road
Parktown
Johannesburg, Gauteng 2193

LEGAL ADVISERS TO THE COMPANY IN AUSTRALIA

Transaction counsel

Herbert Smith Freehills
101 Collins Street
Melbourne VIC 3000

Independent counsel to South32

King & Wood Mallesons
Governor Phillip Tower
1 Farrer Place
Sydney NSW 2000

LEGAL ADVISERS TO THE COMPANY IN THE UNITED KINGDOM

Transaction counsel

Slaughter and May
One Bunhill Row
London EC1Y 8YY

Independent counsel to South32

King & Wood Mallesons LLP
10 Queen Street Place
London EC4R 1BE

LEGAL ADVISERS TO THE COMPANY IN SOUTH AFRICA

Transaction counsel

ENSafrica
150 West Street
Sandton
Johannesburg 2196

Independent counsel to South32

Werksmans Attorneys
155 5th Street
Sandton
Johannesburg 2196

LEGAL ADVISER TO THE COMPANY IN THE UNITED STATES

Transaction counsel

Cleary Gottlieb Steen & Hamilton LLP
One Liberty Plaza
New York NY 10006

REGISTRIES

Principal share registry – Australia

**Computershare Investor Services
Pty Limited**
Yarra Falls 452 Johnston Street
Abbotsford VIC 3067

Branch share registry – South Africa

Computershare Investor Services (Pty) Ltd
70 Marshall Street
Johannesburg 2001

Depository Interests registry – United Kingdom

Computershare Investor Services PLC
The Pavilions Bridgwater Road
Bristol BS99 6ZZ

SHAREHOLDER INFORMATION LINE

If you have any additional questions
in relation to this document or the
Demerger, please call the Shareholder
Information Line on:

BHP Billiton Limited Shareholders

- 1300 582 743 (within Australia)
on weekdays between 8:30am
and 7:30pm (AEDT/AEST);
- +61 3 9415 4808 (international)
on weekdays between 8:30am
and 7:30pm (AEDT/AEST).

BHP Billiton Plc Shareholders

UK register

- 0844 472 7001 (within the United
Kingdom) on weekdays between
8:30am and 5:30pm (GMT/BST);
- +44 844 472 7001 (international)
on weekdays between 8:30am
and 5:30pm (GMT/BST).

South African register

- 086 1100 634 (within South Africa)
on weekdays between 8:00am
and 4:30pm (SAST);
- +27 11 870 8216 (international)
on weekdays between 8:00am
and 4:30pm (SAST).

BHP Billiton ADS Holders

- 877 248 4237 (within the United
States) on weekdays between 8:30am
and 6:00pm (EST/EDT);
- +1 781 575 4555 (international)
on weekdays between 8:30am
and 6:00pm (EST/EDT).

